

# A World of Regulators, Valves & Systems



**TESCOM™**  
Pressure controls for your industry



# Contents

High Pressure – Pressure Reducing Regulators . . . . .	1	Alternative Fuels Regulators . . . . .	8
Low Pressure – Pressure Reducing Regulators . . . . .	2	Pharmpure™ Regulators for Life Sciences . . . . .	8
Low Pressure – Vacuum & Absolute Regulators . . . . .	2	Valves . . . . .	9
High Flow – Pressure Reducing Regulators . . . . .	3	Changeover Regulators . . . . .	10
Back Pressure Regulators . . . . .	4	Integrated Custom Systems . . . . .	10
Hydraulic Regulators – Reducing & Back Pressure . . . . .	5-6	Electronic Pressure Controls . . . . .	11-12
Corrosion Resistant Regulators . . . . .	6-7	Accessories . . . . .	12
Custom – Reducing & Back Pressure . . . . .	7	About TESCO M . . . . .	13

## What to consider when choosing a regulator

Major considerations in the selection of a regulator are listed here. Within the requirements of your specific application, use this catalog to find the regulator that matches your parameters. Our standard products are only a starting point. We can modify or create a control that will solve your toughest application problem. Detailed information is available through your local TESCO M representative.

### HANDKNOB

Large handknob provides easy, low torque pressure setting. Wrench or screwdriver adjust options on some models.

### VENTING

**Venting** feature enables relieving of the outlet pressure when the handknob is turned in the “decrease” direction.

**Captured venting** configuration includes extra port to pipe away expelled fluids from a regulator’s vent valve.

**Non-venting** feature available for hydraulic or other applications where venting is not desirable.

### FLOW CAPACITY – $C_v$

$C_v$  is a measure of regulator flow capacity. The flow coefficient refers to the flow of one GPM of water at one psi drop across the main valve. The coefficient for gaseous service must be determined from the ratio of inlet to outlet pressure.

### BODY MATERIALS

Brass, aluminum or stainless steel (Type 300, 316) and others.

### OUTLET PRESSURE RANGES AVAILABLE

Starting at 50 mm Hg absolute to 15 psig / 1 bar, ranging up to 300-20,000 psig / 21-1379 bar.

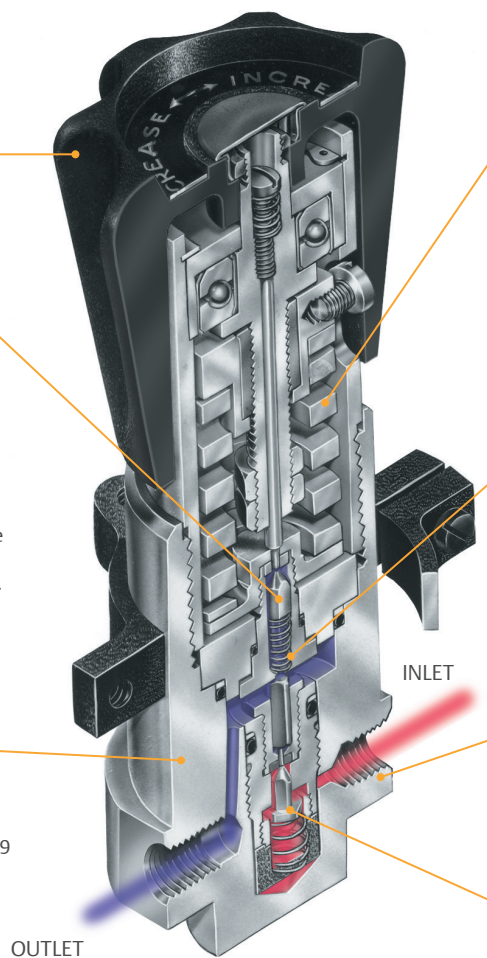

### LOADING – Spring, Dome, Air Actuated, Electronic

Loading refers to the method used to balance the outlet pressure. **Spring loading** is used with direct acting regulators with handknob adjustment. **Dome loading** is most often used in high flow, quick response type applications. **Air Actuator** provides outlet pressures up to 15,000 psig/1035 bar with a signal of only 100 psig/6.9 bar. A TESCO M **electronic** controller is another loading option.

### PANEL MOUNTING

Standard on some models. Extra option on others.

### SENSING – Diaphragm or Piston

**Diaphragms** provide sensitive and accurate regulation for outlet pressure ranges up to 500 psig / 35 bar. **Piston** sensors provide high strength integrity for high outlet pressures up to 20,000 psig / 1379 bar.

### INLET PRESSURE RANGES

Sub-atmospheric to 20,000 psig/1379 bar.

### PORTS

Sizes: 1/8" to 1"  
Types: NPTF (all models), SAE, Aminco, MS33649, Slimline, BSP, welded fittings.

### MAIN VALVES – Balanced and Unbalanced

Balanced design is used to reduce the effect of decaying inlet pressure and in certain models provides increased flow capacity. Unbalanced valve offers simplicity and economy.

### ADDITIONAL CONSIDERATIONS

- Gauge ports, 1/8" or 1/4" NPTF
- Temperature range
- Corrosion resistance
- Welded connections
- Soft goods-Buna-N, PCTFE, Teflon®, Viton-A®, Vespel® and EPR.

Elgiloy® is a registered trademark of Elgiloy Corp.  
Gylon® is a registered trademark of Garlock, Inc.  
LabVIEW® is a registered trademark of National Instruments.  
Hastelloy® is a registered trademark of Haynes International, Inc.  
Teflon®, Viton-A® and Vespel® are registered trademarks of E.I. du Pont de Nemours.  
Windows® and Visual Basic® are registered trademarks of Microsoft Corporation.

# High Pressure - Pressure Reducing Regulators



BB-1 Miniature



44-1100 High Pressure



26-1000 Versatile



26-2000 Versatile

Product Series/Features (Pressure Reducing)	Inlet Pressure (maximum)	Outlet Pressure Ranges	Flow Capacity	Body Material
<b>BB-1 Series: Miniature</b> <ul style="list-style-type: none"> <li>Lightweight, compact design</li> <li>Piston sensed for high cycle life</li> <li>Designed for liquid or gas media</li> <li>Non-venting</li> <li>Field adjustable or pre-set ranges</li> </ul>	6000 psig 414 bar	0-80, 0-140, 0-220, 0-700, 0-1200, 0-1800 psig 0-5.5, 0-9.7, 0-15.2, 0-48.3, 0-83, 0-124 bar	C <sub>V</sub> = .06	Aluminum, 316 SST
<b>BB-5 Series: Miniature, Two Stage</b> <ul style="list-style-type: none"> <li>Lightweight, compact design</li> <li>Interstage relief port</li> <li>Piston sensed for high cycle life</li> <li>Non-venting</li> </ul>	6000 psig 414 bar	0-80, 0-140, 0-220, 0-700, 0-1200 psig 0-5.5, 0-9.7, 0-15.2, 0-48.3, 0-83 bar	C <sub>V</sub> = .06	Aluminum, 316 SST
<b>44-1100 Series: High Pressure</b> <ul style="list-style-type: none"> <li>Excellent sensitivity</li> <li>Piston sensed for high cycle life</li> <li>Inlet &amp; outlet gauge ports standard</li> <li>40 micron (nominal) inlet filter</li> <li>Removable valve module for easy field repair</li> <li>Venting standard</li> </ul>	6000, 10,000 psig 414, 690 bar	5-500, 5-800, 10-1500, 15-2500, 25-4000, 50-6000 psig .35-35, .35-55.2, .69-103.4, 1-172.4 1.7-275.8, 3.5-414 bar	C <sub>V</sub> = .02 C <sub>V</sub> = .06 C <sub>V</sub> = .12	Brass, 300 SST, 316 SST
<b>44-1800 Series: Economy</b> <ul style="list-style-type: none"> <li>General purpose use</li> <li>Compact design</li> <li>Adjustable stop limits maximum outlet pressure</li> <li>Inlet &amp; outlet gauge ports standard</li> <li>Non-venting standard</li> </ul>	6000 psig 414 bar	15-2500 psig 1-172.4	C <sub>V</sub> = .06 C <sub>V</sub> = .24	Brass, 300 SST, 316 SST
<b>26-1000 Series: Versatile</b> <ul style="list-style-type: none"> <li>Outlet pressure ranges are field changeable</li> <li>Numerous porting options</li> <li>Optional inlet pressures to 20,000 psig /1379 bar</li> <li>Large handknob provides fast low-torque pressure settings</li> <li>Venting standard</li> </ul>	6000 & 10,000 psig 690, 414 bar	5-500, 5-800, 10-1500, 15-2500, 25-4000, 50-6000, 200-10,000 psig .35-35, .35-55.2, .69-103.4, 1-172.4 14-690 bar	C <sub>V</sub> = .02 C <sub>V</sub> = .06 C <sub>V</sub> = .12 C <sub>V</sub> = .3	Brass, 300 SST, 316 SST
<b>26-2000 Series: Versatile</b> <ul style="list-style-type: none"> <li>Designed for both hydraulic and pneumatic service</li> <li>Segregated and captured venting</li> <li>Designed for heavy duty shock and vibration service</li> <li>Choice of metal to metal or soft seat</li> <li>Optional inlet pressures up to 30,000 psig /2070 bar &amp; outlet pressures up to 20,000 psig /1379 bar</li> <li>Compatible with TESCOM Electronic Controllers (p. 11-12)</li> </ul>	6000, 10,000, & 15,000 psig 690, 414, 1035 bar	5-500, 5-800, 10-1500, 15-2500, 25-4000, 50-6000, 200-10,000 psig .35-35, .35-55.2, .69-103.4, 1-172.4 1.7-275, 3.5-413 14-690 bar	C <sub>V</sub> = .02 C <sub>V</sub> = .06 C <sub>V</sub> = .12 C <sub>V</sub> = .3	Brass, 316 SST

# Low Pressure - Pressure Reducing Regulators



26-1600 Venting



44-5200 Economical/Venting

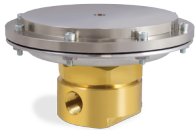

DK Series

Product Series/Features (Pressure Reducing)	Inlet Pressure (maximum)	Outlet Pressure Ranges	Flow Capacity	Body Material
<b>26-1500 Series: Non-venting</b> <ul style="list-style-type: none"> <li>Non-venting regulator</li> <li>Compact design</li> <li>Elastomeric diaphragm - highly sensitive</li> <li>Dome loading available</li> <li>For liquid or gas service</li> </ul>	6000, 5000 psig 414, 345 bar	4-50, 4-150, 4-250 psig .28-3.5, .28-10.4, .28-17.2 bar	C <sub>V</sub> = .08 C <sub>V</sub> = .24	Brass or 316 SST
<b>26-1600 Series: Venting</b> <ul style="list-style-type: none"> <li>Elastomeric diaphragm - highly sensitive</li> <li>Controls up to 500 psig</li> <li>Dome loading available</li> <li>For liquid or gas service</li> <li>Works with TESCOM motorized actuator for remote control</li> </ul>	6000, 5000 psig 414, 345 bar	2-50, 2-150, 3-250, 5-500 psig .14-3.5, .14-10.4, .2-17.2, .35-35 bar	C <sub>V</sub> = .08 C <sub>V</sub> = .24	Brass or 316 SST
<b>44-5200 Series: Economical / Venting / Non-Venting</b> <ul style="list-style-type: none"> <li>Replaces 44-2200V</li> <li>Large piston - good sensitivity</li> <li>For liquid or gas service</li> </ul>	3500, 400 psig 241.3, 27.6 bar	0-25, 0-50, 0-100, 0-250, 0-500, 0-600 psig 0-1.7, 0-3.5, 0-6.9, 0-17.2, 0-35, 0-41.4 bar	C <sub>V</sub> = .06 C <sub>V</sub> = .15	Brass or 316 SST
<b>DK Series: Segregated and Captured Venting</b> <ul style="list-style-type: none"> <li>Improves control and resolution at medium flows &amp; pressures</li> <li>Remote control capability with TESCOM 26-1200 regulator</li> <li>Designed for use with TESCOM ER5000 (p. 11)</li> </ul>	1000 psig 69 bar	Airload: 0-600 psig 0-41.4 bar Dome load: 0-700 psig 0-48.3 bar	C <sub>V</sub> = .35	Brass or 316 SST

# Low Pressure - Vacuum & Absolute Regulators



44-4700 Back Pressure



DV Vacuum Control

Product Series/Features (Absolute)	Inlet Pressure (maximum)	Outlet Pressure Ranges	Flow Capacity	Body Material
<b>44-4600 Series: Absolute Pressure</b> <ul style="list-style-type: none"> <li>Controlled Pressure Range: 28" Hg to 15 psig</li> <li>Large diaphragm - excellent sensitivity</li> </ul>	120, 3500 psig 8.2, 241.3 bar	28" Hg Vac to 15 psig / 1 bar	C <sub>V</sub> = .06 C <sub>V</sub> = .24	316L SST
<b>DA Series: Absolute Pressure</b> <ul style="list-style-type: none"> <li>Sub-atmospheric to 350 psig</li> <li>Non-venting regulator</li> <li>Elastomeric diaphragm sensor - highly sensitive</li> <li>Economical</li> <li>Low knob torque, quick response</li> <li>Dome loaded option</li> </ul>	4500, 500 psig 310.3, 35 bar	Vac. to 15 psig / 1 bar Vac. to 50 psig / 3.5 bar Vac. to 100 psig / 6.9 bar Vac. to 350 psig / 10.4 bar	C <sub>V</sub> = .06	Brass or Aluminum
Product Series/Features (Vacuum)	Controlled Pressure Ranges		Flow Capacity	Body Material
<b>44-4700 Series: Sub-atmospheric, Back Pressure</b> <ul style="list-style-type: none"> <li>High Flow capacity</li> <li>Negative spring bias</li> <li>Controls sub-atmospheric to positive pressures</li> </ul>	28" Hg vac - 15 psig / 1 bar 28" Hg vac - 50 psig / 3.5 bar 28" Hg vac - 100 psig / 6.9 bar 28" Hg vac - 150 psig / 10.4 bar		C <sub>V</sub> = .04 C <sub>V</sub> = .30	316L SST
<b>DV Series: Vacuum control</b> <ul style="list-style-type: none"> <li>Elastomeric diaphragm - highly sensitive</li> <li>Highly accurate: ±1%</li> <li>Dome loaded option</li> <li>Choice of constant or no bleed</li> </ul>	0 psig - 28" Hg (non-bleed) 0 psig - 25" Hg (constant bleed)		C <sub>V</sub> = .25	Brass or Aluminum

# High Flow - Pressure Reducing Regulators



26-1200  $C_v=12$



44-1300 Versatile



44-1500 High Flow



44-4000 Tracking



CP32  
Pilot Operated

Product Series/Features (Pressure Reducing)	Inlet Pressure (maximum)	Outlet Pressure Ranges	Flow Capacity	Body Material
<b>26-1100 Series: Compact/High Flow</b> <ul style="list-style-type: none"> <li>Diaphragm sensed - highly sensitive</li> <li>Modular construction - easy service</li> <li>External sensing available for improved accuracy</li> <li>Balanced main valve increases seat life</li> </ul>	6000, 10,000 psig 414, 690 bar	55-6000, 55-10,000 psig 3.8-414, 3.8-690 bar	$C_v=.46$ $C_v=1.3$	Brass, 300 SST or 316 SST
<b>26-1200 Series: High Flow</b> <ul style="list-style-type: none"> <li>Similar to 26-1100 above with higher flow capacity</li> </ul>	6000 psig 414 bar	100-6000 psig 6.9-414 bar	$C_v=3.3$ $C_v=6.0$ $C_v=12.0$	300 SST or 316 SST
<b>44-1300 Series: Versatile</b> <ul style="list-style-type: none"> <li>Excellent sensitivity</li> <li>Venting</li> <li>Extremely reliable</li> <li>Spring, dome or air ratio loading</li> </ul>	3750, 4500 5000, 6000 psig 259, 310, 345, 414 bar	10-300, 15-600, 20-1000, 50-1500, 50-3000 psig .69-20.1, 1-41.4, 1.4-69, 1.4-103, 1.4-207 bar	$C_v=.8$ $C_v=2.0$	Brass, 300 SST or 316 SST
<b>44-1500 Series: High Flow</b> <ul style="list-style-type: none"> <li>Segregated and captured venting</li> <li>6000 psig inlet</li> <li>Spring, dome or air ratio loading available</li> </ul>	6000 psig 414 bar	10-200, 10-400, 10-600 psig .69-14, .69-27.6, .69-41.4 bar	$C_v=.3$	Brass or 316 SST
<b>44-4000 Series: Tracking</b> <ul style="list-style-type: none"> <li>Segregated and captured venting</li> <li>Adjustable bias pressures</li> <li>Air actuated models are compatible with TESCOM electronic pressure controllers (p. 11-12)</li> </ul>	6000 psig 414 bar	50-1, 500 psig 3.5-103.4 bar Plus Bias Pressures Pressures to 350 psig 24.1 bar	$C_v=.7$ $C_v=2.0$	Brass, 300 SST or 316 SST
<b>44-4200 Series: Economical</b> <ul style="list-style-type: none"> <li>Dome loaded</li> <li>Piston sensed - highly reliable</li> <li>Compatible with TESCOM electronic pressure controllers (p. 11-12)</li> </ul>	6000 psig 414 bar	0-5000 psig 0-345 bar	$C_v=.8$ $C_v=2.0$	Brass, 300 SST or 316 SST
<b>CP32 Series: Pilot Operated</b> <ul style="list-style-type: none"> <li>High flow, low droop</li> <li>Gauge port option</li> <li>Excellent sensitivity and repeatability</li> </ul>	3000 psig 207 bar	500 psig 35 bar	$C_v=1.0$	Brass or 316 SST
<b>DH Series: Low Pressure</b> <ul style="list-style-type: none"> <li>Diaphragm sensed - highly sensitive</li> <li>Excellent repeatability</li> <li>Very high flows at low pressures</li> </ul>	500 psig 35 bar	0-20, 0-50, 0-100, 0-150, 2-250 psig 0-1.4, 0-3.5, 0-6.9, 0-10.4, .14-17.2 bar	$C_v=5.0$	Brass or 316 SST
<b>DG Series: Low Pressure</b> <ul style="list-style-type: none"> <li>Diaphragm sensed</li> <li>High flow - up to 1400 scfm</li> <li>NPTF &amp; welded connections</li> </ul>	300 psig 21 bar	0-20, 0-50, 0-100 0-250 psig 0-1.4, 0-3.5, 0-6.9, 0-17.2 bar	$C_v=10$	316 SST



DH Low Pressure



DG Low Pressure

# Back Pressure Regulators



26-1700  
Versatile



26-2300  
High Accuracy



26-2500  
High Flow



44-1700  
Economical



BB-3 Miniature

Product Series/Features (Back Pressure)	Controlled Pressure Ranges	Flow Capacity	Body Material
<b>26-1700 Series: Versatile</b> <ul style="list-style-type: none"> <li>Extremely sensitive</li> <li>Ideal for both gas &amp; liquid service</li> <li>High temperature versions available up to 650°F /343°C</li> <li>Accuracy : ± 1% of relief pressure range</li> </ul>	5-500, 5-800, 10-1500 15-2500, 25-4000, 50-6000, 200-10,000, 200-15,000 psig .35-35, .35-55.2, .69-103.4, 1-172.4, 1.7-275.8, 3.5-414, 14-690, 14-1035 bar	C <sub>V</sub> = .02 C <sub>V</sub> = .10 C <sub>V</sub> = .14 C <sub>V</sub> = .60	316 SST
<b>26-2300 Series: High Accuracy</b> <ul style="list-style-type: none"> <li>Precise pressure control</li> <li>Diaphragm sensed - highly sensitive</li> <li>Crack to reseal: 2% of set pressure</li> <li>Bubble-tight shutoff at all reseating pressures</li> </ul>	5-50, 10-150, 10-250 psig .35-3.5, .69-10.4, .69-17.2 bar	C <sub>V</sub> = .06 C <sub>V</sub> = .60 C <sub>V</sub> = 1.0	300 or 316 SST
<b>26-2500 Series: High Flow</b> <ul style="list-style-type: none"> <li>Large Gylon® diaphragm for excellent sensitivity</li> <li>Bubble-tight shutoff at all reseating pressures</li> <li>1/2", 3/4" and 1" inlet and outlet port sizes</li> </ul>	0-20, 0-50, 0-125, 0-200 psig 0-1.4, 0-3.5, 0-8.6, 0-14 bar	C <sub>V</sub> = 5.0	Brass or 316 SST
<b>26-2900 Series: Tracking</b> <ul style="list-style-type: none"> <li>High Flow</li> <li>Negative spring bias</li> <li>Designed for BIBS application</li> <li>Diaphragm sensed - highly sensitive</li> </ul>	1000 psig 69 bar	C <sub>V</sub> = 2.0	Brass or 300 SST
<b>44-1700 Series: Economical</b> <ul style="list-style-type: none"> <li>Piston sensed - highly reliable</li> <li>Compact design</li> <li>Close pressure differential between crack and reseal</li> <li>Adjustable pressure stop standard</li> </ul>	40-150, 100-700 or 100-800 psig 2.8-10.4, 6.9-48.3, 6.9-55.2 bar	C <sub>V</sub> = .10	Brass or 316 SST
<b>BB-3 Series: Miniature</b> <ul style="list-style-type: none"> <li>Economical &amp; extremely compact</li> <li>Durable piston sensor design</li> <li>High temperature (to 400°F/204.4°C) version</li> <li>High flow capacity</li> </ul>	0-80, 0-140, 0-220, 0-250*, 0-3000* psig 0-5.5, 0-9.7, 0-15.2, 0-17.2*, 0-207* bar * dome load only	C <sub>V</sub> = .20 C <sub>V</sub> = .50	Aluminum or 316 SST
<b>44-2300 Series: Economical</b> <ul style="list-style-type: none"> <li>Hand adjustable</li> <li>Diaphragm-sensed</li> <li>Dome loaded</li> <li>Four control pressure ranges</li> </ul>	0-25, 0-50, 0-100, 0-250 psig 0-1.7, 0-3.5, 0-6.9, 0-17.2 bar	C <sub>V</sub> = .08	Brass or 316L SST
<b>44-4700 Series: Sub-atmospheric</b> <ul style="list-style-type: none"> <li>Metal to metal diaphragm assures minimum inboard/outboard leakage</li> <li>Controls sub-atmospheric to positive pressures</li> <li>High flow capacity</li> <li>Negative spring bias</li> </ul>	28" Hg VAC - 15 psig/1 bar 28" Hg VAC - 50 psig/3.5 bar 28" Hg VAC - 100 psig/6.9 bar 28" Hg VAC - 150 psig/10.4 bar	C <sub>V</sub> = .04 C <sub>V</sub> = .30	316L SST

# Hydraulic Regulators - Pressure Reducing & Back Pressure



50-2000  
High Pressure



50-2200  
High Pressure



54-2000  
High Pressure



54-2200  
High Pressure

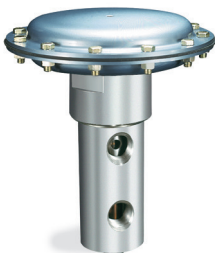

54-2800 High Flow/  
High Pressure

Product Series /Features (Pressure Reducing)	Inlet Pressure (maximum)	Outlet Pressure Ranges	Flow Capacity	Body Material
<b>50-2000 Series: High Pressure /Reducing</b> <ul style="list-style-type: none"> <li>Stem &amp; seal designed to extend service life in crucial high pressure water-based hydraulic applications</li> <li>Integral, segregated and captured venting</li> <li>Tapered poppet design for better pressure control</li> </ul>	10,000, 15,000 psig 690, 1035 bar	5-500, 5-800, 10-1500, 15-2500 25-4000, 50-6000, 200-10,000 psig .35-35, .35-55.2, .69-103.4, 1-172.4 14-690 bar	$C_V = .02$ $C_V = .06$ $C_V = .12$ $C_V = .30$	316 SST
<b>50-2200 Series: High Pressure /Reducing</b> <ul style="list-style-type: none"> <li>Designed with special stem and seal to meet the challenges of water-based fluid applications</li> <li>Spring-loaded, wrench adjust for outlet pressures up to 20,000 psig/1379 bar</li> <li>Integral, segregated and captured venting</li> </ul>	15,000, 20,000 psig 1035, 1379 bar	300-15,000, 300-20,000 psig 20-1035, 20-1379 bar	$C_V = .06$ $C_V = .12$	316 SST or Nitronic 60
<b>54-2000 Series: High Pressure /Reducing</b> <ul style="list-style-type: none"> <li>Rugged design, high pressure service</li> <li>Hardened metal to metal seats for heavy duty service</li> <li>System pressures to 20,000 psig /1379 bar available</li> <li>Integral, segregated and captured venting</li> </ul>	10,000 psig 690 bar	5-500, 5-800, 10-1500, 15-2500, 25-4000, 50-6000, 200-10,000 psig .35-35, .35-55.2, .69-103.4, 1-172.4 1.7-275.8, 3.5-414, 14-690 bar	$C_V = .06$	300 or 316 SST
<b>54-2200 Series: High Pressure</b> <ul style="list-style-type: none"> <li>High flow capacity: <math>C_V = 2.0</math></li> <li>Hardened metal to metal seats for heavy duty service</li> <li>Integral, segregated and captured venting</li> </ul>	8000 psig 10,000 psig 552, 690 bar	5-500, 5-800, 10-1500, 15-2500, 25-400, 50-6000, 200-10,000 psig .35-35, .35-55.2, .69-103.4, 1-172.4 1.7-275.8, 3.5-414, 14-690 bar	$C_V = 2.0$	300 SST
<b>54-2800 Series: High Flow /Reducing</b> <ul style="list-style-type: none"> <li>Flow capacity: <math>C_V = 8.0</math></li> <li>Inlet &amp; outlet pressures up to 5000 psig/345 bar</li> <li>Choice of air ratio or dome loading</li> <li>Hardened metal to metal seats for heavy duty service</li> <li>Integral, segregated and captured venting</li> </ul>	5000 psig 345 bar	50-1500, 200-5000 psig 3.5-103.4, 14-345 bar	$C_V = 8.0$	300 SST
Product Series/Features (Back Pressure)	Controlled Pressure Ranges		Flow Capacity	Body Material
<b>54-2100 Series: Back Pressure /Relief Valve</b> <ul style="list-style-type: none"> <li>Accuracy: <math>\pm 1\%</math> of pressure range</li> <li>Hardened metal to metal seats for heavy duty service</li> <li>Eight pressure ranges up to 15,000 psig /1035 bar</li> </ul>	0-500, 0-800, 10-1500, 15-2500, 25-4000, 50-6000, 200-10,000, 300-15,000 psig .35-35, .35-55.2, .69-103.4, 1-172.4 1.7-275.8, 3.5-414, 14-690, 20.7-1035 bar		$C_V = .08$	300 or 316 SST
<b>54-2300 Series: High Pressure /High Flow - BPR</b> <ul style="list-style-type: none"> <li>Control pressures to 10,000 psig/690 bar</li> <li>Flow capacity: <math>C_V = 1.6</math></li> <li>Excellent crack to reseat ratio</li> <li>Hardened metal to metal seats for heavy duty service</li> </ul>	750, 1500, 3500 5000, 10,000 psig 51.7, 103.4, 241.3, 345, 690 bar		$C_V = 1.6$	300 SST

# Hydraulic Regulators - Pressure Reducing & Back Pressure



54-2700 High Flow/  
Back Pressure

Product Series/Features (Back Pressure)	Controlled Pressure Ranges	Flow Capacity	Body Material
<b>54-2700 Series: High Flow/Back Pressure</b> <ul style="list-style-type: none"> <li>Flow capacity: <math>C_V=5.0</math></li> <li>Choice of dome loaded, spring loaded, or air ratio device</li> </ul>	5-500, 50-5500 psig .35-35, .35-379 bar	$C_V=2.0$ $C_V=5.0$	300 or 316 SST
<b>54-2900 Series: High Flow/Back Pressure</b> <ul style="list-style-type: none"> <li>Control pressures up to 10,000 psig</li> <li>Bottom ported outlet; hardened metal to metal seats for heavy duty service</li> <li>Dome, spring loaded and air actuated</li> </ul>	500, 1000, 1500, 3000 5000, 10,000 psig 35, 69, 103, 207, 345, 690 bar	$C_V=5.0$	316 SST

# Corrosion Resistant, Specialty Gas & Petrochemical Regulators



04 Miniature/  
Lecture Bottle



44-2200 Compact



44-3200 High Flow/  
Purge



44-3400 Two Stage

Product Series /Features (Pressure Reducing)	Inlet Pressure (maximum)	Outlet Pressure Ranges	Flow Capacity	Body Material
<b>04 Series: Miniature /Lecture Bottle</b> <ul style="list-style-type: none"> <li>Choice of 1/8" or 1/4" in &amp; out ports</li> <li>Minimal internal volume</li> <li>Choice of 316 SST or brass</li> </ul>	3500 psig 241.3 bar	0-30, 0-60, 0-100 psig 0-2, 0-4.1, 0-6.9 bar	$C_V=.06$	Brass or 316L SST
<b>44-2200 Series: Compact/General Purpose</b> <ul style="list-style-type: none"> <li>1/4" inlet and outlet ports</li> <li>Diaphragm sensed - highly sensitive</li> <li>Various trim options available</li> </ul>	3500, 400 psig 241.3, 27.6 bar	1-25, 1-50, 1-100, 2-250, 2-500 psig .07-1.7, .07-3.5, .07-6.9, .14-17.2, .14-35 bar maximum	$C_V=.02$ $C_V=.06$ $C_V=.15$ $C_V=.24$	Brass, 316L SST, Hastelloy-C® or Monel®
<b>44-2600 Series: General Purpose /Large Diaphragm</b> <ul style="list-style-type: none"> <li>Increased sensitivity, minimal droop</li> <li>Repeatability: <math>\pm 1/2\%</math> of outlet pressure range</li> <li>Accuracy: <math>\pm 1\%</math> of outlet pressure</li> </ul>	3500, 400 psig 241.3, 27.6 bar	1-25, 1-50, 1-100, 1-150 psig .07-1.7, .07-3.5, .07-6.9, .07-10.4 bar	$C_V=.02$ $C_V=.06$ $C_V=.15$ $C_V=.24$	316L SST
<b>44-2800 Series: Positive Seal</b> <ul style="list-style-type: none"> <li>Mechanical link between diaphragm &amp; main valve prevents pressure creep</li> <li>Positionable captured vent bonnet</li> </ul>	3000 psig 207 bar	1-25, 1-50, 1-100, 1-150 psig .07-1.7, .07-3.5, .07-6.9, .07-10.4 bar	$C_V=.16$	316L SST
<b>44-3200 Series: High Flow/Purge</b> <ul style="list-style-type: none"> <li>Ideal purge regulator</li> <li>High pressure inlet version incorporates a balanced main valve to minimize inlet pressure fluctuation</li> </ul>	500, 3000 psig 35, 207 bar	5-25, 5-50, 5-100, 5-150, 5-200 psig .35-1.7, .35-3.5, .35-6.9, .35-10.4, .35-14 bar	$C_V=1.0$ $C_V=1.8$	Brass or 316L SST
<b>44-3400 Series: General Purpose /Two Stage</b> <ul style="list-style-type: none"> <li>Decaying inlet characteristic: .04 per 100 psig inlet pressure change</li> <li>Various trim options available</li> </ul>	3500 psig 241.3 bar	2-25, 2-50, 3-100 3-150, 3-250 psig .14-1.7, .14-3.5, .21-6.9, .21-10.4, .21-17.2 bar	$C_V=.05$	Brass or 316L SST
<b>44-5000 Series: Absolute Pressure</b> <ul style="list-style-type: none"> <li>Control pressure range: vacuum to low positive pressures</li> </ul>	120, 400, 3500 psig 8.3, 27.6, 241.3 bar	28" Hg Vac to 15 psig/1bar 28" Hg Vac to 25 psig /1.7 bar 28" Hg Vac to 50 psig /3.5 bar 28" Hg Vac to 100 psig /6.9 bar	$C_V=.06$ $C_V=.15$ $C_V=.24$	316L SST
<b>FR 2000 Series: Facilities Regulator</b> <ul style="list-style-type: none"> <li>Ideal purge regulator for low pressure systems</li> <li>Negative bias spring enhances performance at low pressures</li> <li>Balanced main valve minimizes inlet pressure fluctuations</li> </ul>	500 psig 35 bar	0-15, 0-30, 0-75, 0-150 psig 0-1, 0-2, 0-5.2, 0-10.4 bar	$C_V=1.8$	316L SST



# Corrosion Resistant, Specialty Gas & Petrochemical Regulators



SG1  
(with accessories)



44-5800  
Electric Heated  
Vaporizing

Product Series/Features (Pressure Reducing)	Inlet Pressure (maximum)	Outlet Pressure Ranges	Flow Capacity	Body Material
<b>SG Series: SG1 &amp; SG3 Single-Stage, SG2 Two-Stage</b> <ul style="list-style-type: none"> <li>• 316 SST or Neoprene diaphragm - for increased regulator endurance</li> <li>• 10 micron filter - longer service life</li> <li>• Easy to configure with accessories and order</li> <li>• Faster delivery - most ship from stock</li> </ul>	4500 psig 310 bar	15, 25, 50, 125, 250 psig 1, 1.7, 3.4, 8.6, 17.2 bar	$C_V = .06$ $C_V = .20$ $C_V = 1.0$	316L SST & Nickel-plated Brass
<b>44-5800 Series: Vaporizing Regulator</b> <ul style="list-style-type: none"> <li>• Available in steam heated &amp; electric heated versions</li> <li>• Superior heat transfer technology with tolerance to voltage spikes &amp; high ambient temperatures</li> <li>• Optional heating capacity up to 400 watts for faster response to flow variations</li> <li>• Electric unit designed for 120VAC/240VAC, 50/60 Hz</li> <li>• 4-20 mA analog output capability for remote temperature monitoring &amp; data acquisition</li> <li>• Optional LCD temperature display</li> <li>• T4 rating for ATEX, IECEx &amp; CSA</li> </ul>	6000 psig 414 bar	Up to 500 psig 35 bar	$C_V = .02$	316L SST or Monel®
Product Series/Features (Back Pressure)	Controlled Pressure Ranges		Flow Capacity	Body Material
<b>44-2300 Series: Back Pressure</b> <ul style="list-style-type: none"> <li>• Economical, general purpose</li> </ul>	0-25, 0-50, 0-100, 0-250 psig 0-1.7, 0-3.5, 0-6.9, 0-17.2 bar		$C_V = .08$	Brass or 316L SST

# Custom Pressure Reducing & Back Pressure Regulators



Cartridge Regulator  
(BB Series)



42 MW Welded Diaphragm  
Instrument Isolator  
(shown with the  
SJS Series regulator)



Air Actuator  
(26-2000 Series)

## Cartridge Regulators

- Cartridge style externally threaded regulators are designed to be easily installed in a manifold block
- Obvious benefits include: reduced piping, elimination of connections, reduced space requirement, ease of service
- Can be furnished in a wide variety of pressure reducing or back pressure styles
- Contact factory for application assistance

## Differential / Tracking Regulators

- Designed to provide a controlled pressure which is the sum of a signal (reference) pressure and a bias pressure (bias can be positive or negative)
- Applications include: automatic pressure compensation for mechanical (pump) seals, control of fugitive emissions, reduction of breathing gases in commercial or military diving

## SJS Series Regulator

- Maintains accurate differential pressure when incorporated into a double seal system
- Tracks upsets in system pressure and decreases downtime by increasing seal life

## 42 MW Welded Diaphragm Instrument Isolator

- Isolates and protects the regulator from corrosive process media
- Intended for use with our wide range of tracking regulators
- Assists in the control of pressure in fugitive emission and/or mechanical seals applications

## Air Actuators

- Available for a wide range of pressure reducing and back pressure regulators
- Allows regulator to be remote actuated by an air signal from an external air source or by one of TESCO's electronic controllers
- Control pressures may vary from 20 to 20,000 psig / 1.4 to 1379 bar
- Ratios between actuator pressure and control pressure are available from 3:1 to 150:1
- Compared to conventional spring loading, air actuation offers improved regulator performance

# Alternative Fuels Regulators



20-1200  
High Pressure  
Hydrogen



20-1400  
High Flow/  
Low Pressure

Product Series /Features	Inlet Pressure (maximum)	Outlet Pressure Ranges	Flow Capacity	Body Material
<b>20-1000 Series: Compressed Natural Gas</b> <ul style="list-style-type: none"> <li>Balanced main valve minimizes inlet pressure fluctuations</li> <li>Piston sensed - highly reliable</li> <li>Water heat jacket standard</li> </ul>	3600 psig 248 bar	0-500 psig 0-35 bar	$C_v = .5$	Aluminum
<b>20-1200 Series: High Pressure Hydrogen</b> <ul style="list-style-type: none"> <li>Nickel-plated aluminum</li> <li>Large piston sensor</li> <li>All regulators tamper-proof</li> </ul>	5000 psig 345 bar	0-500 psig 0-35 bar	$C_v = .5$	Aluminum 316 SST
<b>20-1400 Series: High Flow / Low Pressure</b> <ul style="list-style-type: none"> <li>Diaphragm sensed - highly sensitive</li> <li>Dome load spring bias <math>\pm 2</math> psig/.14 bar</li> <li>Captured bonnet design for safety</li> </ul>	250 psig 17.2 bar	0-190 psig 0-13 bar	$C_v = 1.6$	Aluminum

# Clean Pharpure™ Regulators for Life Sciences



PH-1800 Low Pressure  
Very High Flow



PH-2200 - Low Flow



PH-2600 - Low Flow



PH-3200 - Medium Flow

All Pharpure™ regulators are compliant with the MJ and SF sections of BPE-2009. Clean Service Certification option is available.				
Regulator Series /Features	Inlet Pressure (maximum)	Outlet Pressure Ranges	Flow Capacity	Body & Finishes
<b>PH-1600: Low Pressure, High Flow</b> <ul style="list-style-type: none"> <li>FDA Title 21 &amp; USP Class VI Materials</li> <li>Flows to 250 SCFM N<sub>2</sub></li> <li>Gas and clean steam versions</li> <li>Ports from 1/2" - 1 1/2" tube ends, sanitary</li> </ul>	300 psig 20.7 bar	1-20, 1-50, 1-100, 2-300 psig .07-1.4, .07-3.5, .07-6.9, .14-20.7 bar	$C_v = 5.0$	Brass or 316L SST 25 R <sub>a</sub> available (SST version only)
<b>PH-1800: Low Pressure, Very High Flow</b> <ul style="list-style-type: none"> <li>FDA Title 21 &amp; USP Class VI Materials</li> <li>Flows to 1400 SCFM N<sub>2</sub></li> <li>Gas and clean steam versions</li> <li>Ports from 3/4" - 1 1/2" tube ends, sanitary</li> </ul>	300 psig 20.7 bar	1-20, 1-50, 1-100, 2-150 psig .07-1.4, .07-3.5, .07-6.9, .14-10.4 bar	$C_v = 10$	Brass or 316L SST 25 R <sub>a</sub> available (SST version only)
<b>PH-2200: Compact, Low Pressure, Low Flow</b> <ul style="list-style-type: none"> <li>FDA Title 21 &amp; USP Class VI Materials</li> <li>Flows to 5 SCFM for specialty gas &amp; clean air applications</li> <li>Ports from 3/8" - 1/2" tube ends, sanitary</li> </ul>	150 psig 10.4 bar	1-10, 1-25, 1-50, 1-100 psig .07-.69, .07-1.7	$C_v = .06$ $C_v = .15$ $C_v = .24$	Brass or 316L SST 15 or 32 R <sub>a</sub> available (SST version only)
<b>PH-2600: Compact, Low Pressure, Low Flow</b> <ul style="list-style-type: none"> <li>FDA Title 21 &amp; USP Class VI Materials</li> <li>Flows to 10 SCFM for specialty gas &amp; clean air applications</li> <li>Ports from 3/8" - 1/2" tube ends, sanitary</li> </ul>	150 psig 10.4 bar	1-10, 1-25, 1-50, 1-100 psig .07-.69, .07-1.7	$C_v = .06$ $C_v = .15$ $C_v = .24$	Brass or 316L SST 15 or 32 R <sub>a</sub> available (SST version only)
<b>PH-3200: Compact, Low Pressure, Medium Flow</b> <ul style="list-style-type: none"> <li>FDA Title 21 &amp; USP Class VI Materials</li> <li>Gas and clean steam versions</li> <li>Tracking version for agitator seals</li> <li>Gas flows to 50 SCFM N<sub>2</sub></li> </ul>	500 psig 35 bar	5-25, 5-50, 5-100 psig .35-1.7, .35-3.5, .35-6.9 bar	$C_v = 1.0$ $C_v = 1.8$	Brass or 316L SST 15 or 32 R <sub>a</sub> available (SST version only)

# Valves



30-1100 Shutoff Valve



VA & VG Air-Operated ON/OFF Valves



VA Valve - toggle actuated



VJ Bidirectional Shut-off Valve

Product Series/Features	Operating Pressure (maximum)	Flow Capacity	Body Material
<b>30 Series: Shutoff Valves</b> <ul style="list-style-type: none"> <li>Globe or angle pattern</li> <li>Built-in metallic stop prevents over-torquing - reduces seat wear</li> <li>30-1100 Series: available with metering capability (long stem optional)</li> <li>Bidirectional flow (all models)</li> </ul>	10,000 psig 690 bar	30-1100 globe: $C_V = .28$ 30-1100 angle: $C_V = .49$ 30-1300 globe: $C_V = 1.57$ 30-1300 angle: $C_V = 2.30$ 30-1200 globe: $C_V = 8.0$ 30-1200 angle: $C_V = 10.0$ 30-1400 globe: $C_V = 20.0$	300 SST
<b>VA &amp; VG Series: Air Operated ON/OFF Valves</b> <ul style="list-style-type: none"> <li>Normally open or normally closed</li> <li>Balanced main valve - reduces required actuation pressure (30-60 psig)</li> <li>Compact package</li> <li>Toggle actuator optional</li> <li>Solenoid valve actuation (pneumatic assist) optional</li> </ul>	6000, 10,000, 15,000, 20,000 psig 414, 690, 1035, 1380 bar	VA: $C_V = .75$ VG: $C_V = 2.0$	Brass or 316 SST
<b>VJ Series: Cartridge Valves</b> <ul style="list-style-type: none"> <li>Bidirectional flow</li> <li>Built-in metallic stop</li> <li>Globe or angle pattern</li> <li>O<sub>2</sub> compatible design</li> </ul>	6000, 10,000 psig 414, 690 bar	angle: $C_V = .49$ globe: $C_V = .28$	Brass or 316 SST
<b>VL Series: <math>C_V=10</math></b> <ul style="list-style-type: none"> <li>Balanced main valve - reduces required actuation pressure</li> <li>Normally closed</li> <li>In-line flow configuration</li> </ul>	6000 psig 414 bar	$C_V=10$	316 SST
<b>VT Series: 3-Way Valve</b> <ul style="list-style-type: none"> <li>High cycle life in compact design</li> <li>3 way, 2 position</li> <li>Balanced main valve</li> <li>Optional solenoid valve</li> <li>Universal operation</li> <li>Class VI shut-off</li> </ul>	3500 psig 6000 psig 10,000 psig 241.3, 414, 1035 bar	$C_V = .75$	Brass or 316 SST



VL Series  $C_V=10$  In-line Valve



VT Series 3-Way Valve



VN Series Bidirectional Valve

# Changeover Regulators



ACS012 Automatic Changeover



ACS3200 Changeover System



CR441800 Changeover System



CS-2200 Changeover System



NA-4 Changeover System

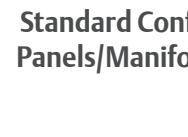

Auto Cascade System

Product Series/Features	Inlet Pressure (maximum)	Outlet Pressure Ranges	Flow Capacity	Body Material
<b>ACS012 Series: Automatic Changeover</b> <ul style="list-style-type: none"> <li>Eliminates downtime caused by depleted gas supplies</li> <li>Incorporates 44-2200 regulators</li> </ul>	400, 3500 psig 27.6, 241.3 bar	100, 150, 200, 250 psig 6.9, 10.4, 14, 17.2 bar	$C_V = .06$	Brass or 316L SST
<b>ACS3200 Series: High Flow Changeover</b> <ul style="list-style-type: none"> <li>High flow capacity: 50 scfm</li> <li>Based on TESCO's field-proven 44-3200 Series Regulator</li> <li>Eliminates downtime caused by depleted gas supplies</li> </ul>	3000 psig 207 bar	160-200 psig 11-14 bar	$C_V = 1.2$	Brass or 316L SST
<b>CR441800 Series: High Pressure Changeover</b> <ul style="list-style-type: none"> <li>Inlet pressures up to 6000 psig</li> <li>Based on TESCO's field proven 44-1800 Series Regulator</li> <li>Eliminates downtime caused by depleted gas supplies</li> </ul>	3500, 6000 psig 241.3, 414 bar	5-500, 5-600, 10-700, 10-800, 10-900, 10-1,000 psig .35-35, .35-41.4, .69-48.3, .69-55.2, .69-62, .69-69 bar	$C_V = .06$	Brass or 316L SST
<b>CS-2200 Series: Changeover System</b> <ul style="list-style-type: none"> <li>Eliminates downtime caused by depleted gas supplies</li> <li>Single body changeover regulator plus a point-of-use regulator</li> <li>Incorporates 44-2200 regulators</li> </ul>	3500 psig 241.3 bar	0-25, 0-50, 0-100, 0-150 psig 0-1.7, 0-3.5, 0-6.9, 0-10.3 bar	$C_V = .06$	Brass or 316L SST
<b>NA-4 Series: Changeover System</b> <ul style="list-style-type: none"> <li>Includes changeover &amp; line regulator, cylinder, vent &amp; outlet shutoff valves</li> <li>High pressure line regulators up to 1500 psig</li> <li>Supports up to eight cylinders per side</li> <li>Optional remote mount annunciator</li> </ul>	3000 psig	30, 50, 100, 150, 200, 300, 500, 750, 1000, 1500 psig 2, 3.5, 6.9, 10.3, 13.8, 20.7, 35, 51.7, 69, 130.5 bar	$C_V = .06$	Brass or 316L SST
<b>Auto Cascade System</b> <ul style="list-style-type: none"> <li>Automatic operation and priority fill</li> <li>10,000 psig /690 bar maximum operating pressure</li> </ul>				<ul style="list-style-type: none"> <li>Simultaneously charge and dispense</li> <li>Cartridge servicing for easy maintenance</li> </ul>

## Integrated Custom Systems

Integrated custom systems simplify your pressure, flow & measurement applications. We provide standard designs and custom solutions from the component level and up – capabilities not found with other system integrators. From idea to implementation, whether simple or complex, TESCO has the expertise to deliver the final product that meets or exceeds your expectations.

Standard Configurable Panels/Manifold Blocks

Closed Loop Electronic Control

Custom Manifold Blocks/Panels

Automated Test Stands

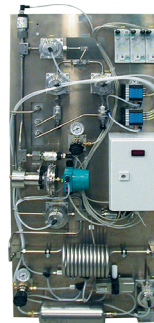
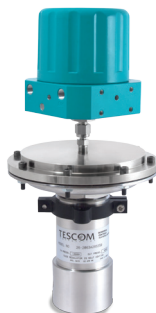

LEVEL OF INTEGRATION

# Electronic Pressure Controls



ER5000 Digital Pressure Controller



ER5000 Kit Back Plate Pressure Reducing



ER5040 Series

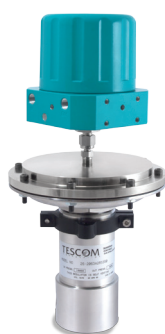

ER5000 / 26-2000 Series

## ER5000 Series Digital Pressure Controller

- Precise accuracy:  $\pm .1\%$  FSO!
- Features controlled outlet pressure from 0-100 psig/0-6.9 bar as a stand alone unit
- Compatible pressure regulators available offering vacuum to 20,000 psig/1379 bar control
- Selectable setpoint signal source:
  - External analog, digital USB or RS485, downloadable profile
- Selectable feedback signal source:
  - Internal 0-100 psig/0-6.9 bar sensor or external analog
- NEMA 4X enclosure
- CE and CSA approved
- Two enhanced versions, ER5000FI and FV, offer additional analog/digital inputs and conditional control profile segments, IF and GOTO, allowing the user even more sophisticated control. These models also include analog sensor output and "Suspend Control" mode which suspends the control algorithm and locks outlet pressure to ensure total stability.
- Free tuning and interface software provided
- RS485 converters and power supplies also available

## ER5000 Kits

ER5000 Pressure Reducing and Backpressure kits are engineered to provide all the equipment needed to get your pressure control system up and running with minimum effort on your part.

- No guesswork - everything you need is pre-assembled onto a back plate or mounted within an enclosure
- Saves time, money & headaches
- Tuned and tested before delivery

### Kits include:

- ER5000FI-1
- Pressure reducing or backpressure regulator
- 4-20 mA feedback transducer
- ER supply regulator (optional)
- All connections and fittings
- ER junction box (optional)
- Documentation package

## ER5040 Series

- Features of the ER5000 with OEM base, no cover
- Not available in Explosion-Proof

## ER5000 / 26-2000 Series - High Accuracy, High Pressure Control

- Designed for applications where high accuracy and reliability are critical
- Choice of outlet pressure ranges to 20,000 psig/1379 bar
- Excellent for calibration systems

## ER5020 Series - High Pressure, Low Flow Integrated Systems

- Integrates with 26-1000 Dual Piston Regulator to achieve 10-9000 psig/.69-620 bar in 395 milliseconds
- Choice of outlet pressure ranges to 10,000 psig/690 bar
- Gas or liquid applications
- Segregated venting
- Flow capacity:  $C_V=0.06$
- Other integrated regulators available

## ER5100 Series - High Flow Control

- Integrates with 44-4000 venting regulator
- Choice of 500 or 900 psig/35 or 62 bar outlet ranges
- Flow capacity:  $C_V=0.7$  or 2.0
- Available in brass or stainless steel

# Electronic Pressure Controls



ER5110 Compact Integrated Unit



269-529 Low Pressure/High Flow Regulator



70-2000 Motorized Actuator

<p><b>ER5110 Series - Compact Integrated Unit</b></p> <ul style="list-style-type: none"> <li>Integrates with 44-5200 regulator, standard options available</li> <li>Features identical to the ER5000 (shown on page 11)</li> <li>Choice of outlet pressure ranges to 500 psig/35 bar</li> <li>Reference pressure: 100 psig/6.9 bar</li> <li>Flow capacity: <math>C_V=0.06</math> or <math>0.15</math></li> <li>Venting or non-venting</li> </ul>
<p><b>ER3000 Series Explosion-Proof Control</b></p> <ul style="list-style-type: none"> <li>FM approved enclosure for Class 1, Division 1, Group B, C and D, ER3000EX and ER3000GX</li> <li>ATEX approved enclosure for use in areas per ATEX marketing: II 2 G EEx d IIB + H2T4</li> <li>Same features and benefits as ER3000</li> </ul>
<p><b>269-529 Series - Low Pressure/High Flow Pressure Regulator</b></p> <ul style="list-style-type: none"> <li>Maximum inlet pressure: 300 psig/20 bar</li> <li>Controlled outlet pressure to 100 psig/6.9 bar, some models up to 300 psig/20 bar</li> <li>Ports from 1/4" to 2-1/2"</li> <li>Flow capacity: <math>C_V</math> values up to 45</li> <li>Exceptional low pressure control throughout flow range</li> </ul>
<p><b>70-2000 Series Motorized Actuator</b></p> <ul style="list-style-type: none"> <li>24 VDC motorized actuator provides remote adjustment of regulator setpoint</li> <li>Adaptable to 26-1000, 26-1600, 26-1700, 26-2300, 54-2000 and 54-2100 Series Regulators</li> <li>Variable speed control with adjustable limit stops to prevent over-travel</li> </ul>
<p><b>Pressure Transducers</b></p> <ul style="list-style-type: none"> <li>Ideal for use in ER5000 applications where an external feedback is required</li> <li>Provides extremely stable and repeatable hydraulic and pneumatic pressure measurements</li> <li>.1%, 0.25% and 0.5% accuracy available</li> <li>Choice of 4-20 mA, 0-10 VDC versions</li> <li>Wide choice of pressure ranges (including sub-atmospheric)</li> </ul>

## Accessories



Gauges



Mini In-Line Filters 98 Series

Product Series/Features	Operating Pressure (maximum)	Body Material
<p><b>Pressure Gauges (2" &amp; 2.5" dia.)</b></p> <ul style="list-style-type: none"> <li>Brass or Stainless Steel construction</li> <li>Pressure ranges from sub-atmospheric to 10,000 psig/690 bar</li> <li>1/4" connections</li> </ul>	sub-atmospheric to 10,000 psig/690 bar	Brass or 316 SST
<p><b>Filters - High Pressure (10 micron)</b></p> <ul style="list-style-type: none"> <li>98-1010 Series Mini In-Line filter:                             <ul style="list-style-type: none"> <li>For systems with size limitations</li> </ul> </li> <li>98-1110 Series T-Type Filter:                             <ul style="list-style-type: none"> <li>Designed for high flow applications</li> <li>Features cleanable element</li> <li>Available options: electrical, visual, bypass valve, visual pressure differential indicator, bypass relief valve, electrical bypass</li> </ul> </li> <li>98-1210 Series In-Line Filter:                             <ul style="list-style-type: none"> <li>For systems with size limitations</li> <li>Cleanable element</li> </ul> </li> </ul>	<p>6,000 psig 414 bar</p> <p>6,000, 10,000 psig 414, 690 bar</p> <p>3,000, 6,000, 10,000 psig 207, 414, 690 bar</p>	<p>304 SST</p> <p>300 SST</p> <p>300 and 17-4 SST</p>

# TESCOM Manufacturing & Distributor Network... a worldwide presence!



**NORTH AMERICA**  
Elk River, Minnesota USA



**EUROPE**  
Selmsdorf, Germany



**ASIA PACIFIC**  
Pudong Shanghai, China

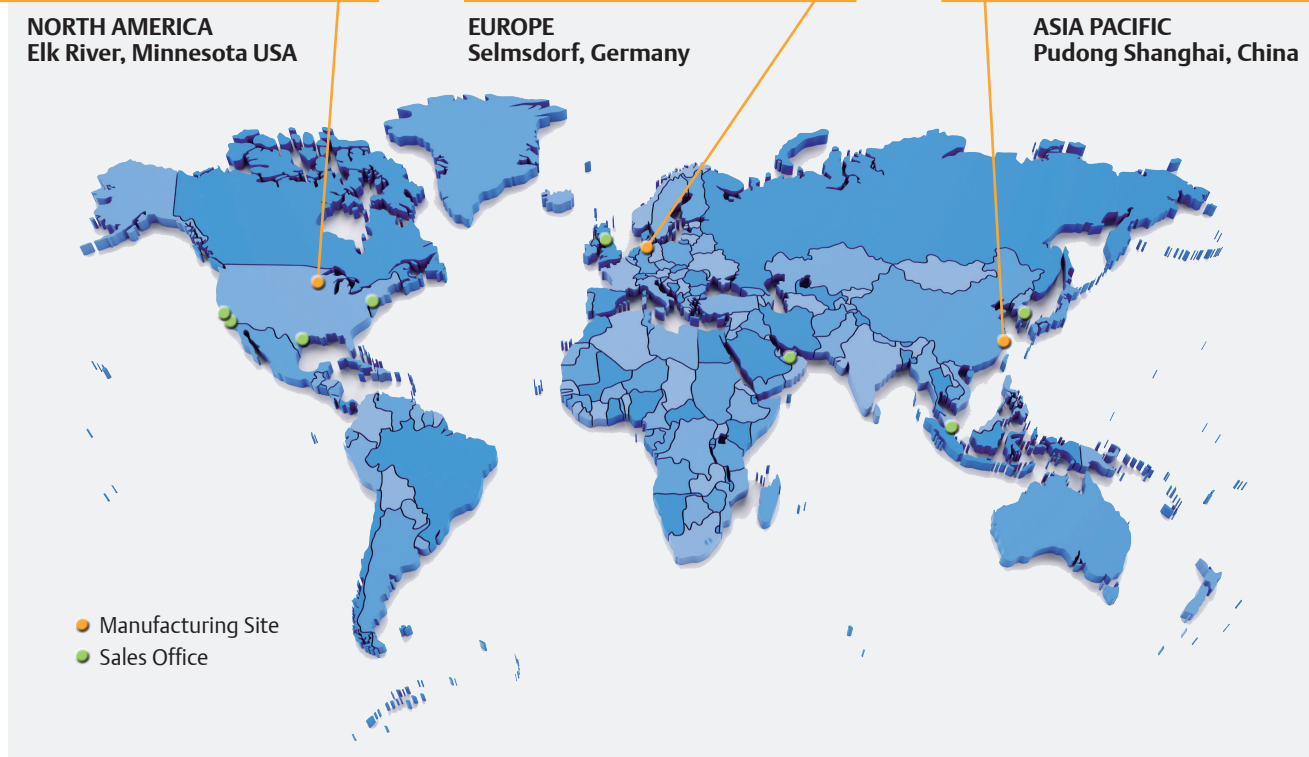

TESCOM™ designs and manufactures a wide range of standard and custom engineered pressure control solutions for a diverse world market. Whether your needs are components like regulators and valves or pressure systems and assemblies, TESCO provides expert application and customer support from simple industrial applications to high tech complex projects. Market application know-how includes Aerospace & Defense, Alternative Fuels, Diving & Life Support, Laboratory & Research, Life Sciences, Medical, Oil & Gas and Microelectronics to name just a few. Close collaboration between worldwide design and manufacturing groups ensure the usage of state-of-the-art production technologies to provide the innovation and highest quality product that TESCO customers have come to expect.

TESCOM distributor support centers are located in most major cities worldwide. More than 100 locations provide application assistance and quality TESCO product.

TESCOM sales offices are located in California, Texas and New Jersey USA, United Kingdom, Germany, Singapore, South Korea and United Arab Emirates.

For a distributor or sales office location near you, visit [www.tescom.com](http://www.tescom.com) and click on the **Sales Locator** link.



*Ultra-high purity pressure controls are available. These products are designed for semiconductor, flat panel displays, photovoltaic and other microelectronic applications.*

**We are your worldwide partner  
in precision pressure control.**



The contents of this publication are presented for information purposes only, and while effort has been made to ensure their accuracy, they are not to be construed as warranties or guarantees, express or implied, regarding the products or services described herein or their use or applicability. All sales are governed by our terms and conditions, which are available on request. We reserve the right to modify or improve the designs or specifications of our products at any time without notice.

**An ISO 9001 Quality System Certified Company**

**経済産業大臣認定試験者  
METI Certified Self-Inspecting Manufacturer  
MAB 491-N**

**Americas**

Emerson Automation Solutions  
TESCOM  
12616 Industrial Blvd.  
Elk River, MN 55359  
United States

T +1 800 447 1250

**Americas**

Emerson Automation Solutions  
TESCOM  
5801 East Harrison  
Harlingen, TX 78550  
United States

T +1 800 447 1250

**Europe**

Emerson Automation  
Solutions  
TESCOM  
An der Trave 23-25  
23923 Selmsdorf  
Germany

T +49 38823 31 284

**Asia Pacific**

Emerson Automation Solutions  
TESCOM  
Building 40B-2  
1006 Jin Min Road  
Shanghai Pu Dong District  
Shanghai 201206, China

T +86 21 2892 9000 (China)  
T +65 6777 8211 (Singapore)

tescom\_web@emerson.com for TESCOM



Emerson.com



LinkedIn.com/company/emerson

The Emerson logo is a trademark and service mark of Emerson Electric Co. TESCOM is a registered trademark. All other marks are the property of their respective owners. © 2019 Emerson Electric Co. All rights reserved.

