

Monitoring Steam Purity in Power Plants

Part 1: Using Conductivity

Utility operators have long known that contaminated steam can cause severe damage to the turbine, leading to lengthy unplanned outages, expensive repairs, and loss of revenue. Every plant has equipment and procedures in place for controlling steam purity, and no program can be successful without process analyzers for continuously monitoring contamination levels. This Application Note discusses the use of conductivity in steam purity monitoring. Part 2 discusses the measurement of individual contaminants.

BACKGROUND

Impurities in steam lead to both corrosion and deposit formation in the turbine. The major corrosion-causing impurities are sodium, chloride, and sulfate, and the most significant scale-forming contaminant is silica. All are constituents of raw water and enter the cycle through condenser tube leaks and poor quality makeup water (see Figure 1). Other potential threats are organic acids and carbon dioxide. Organic acids are usually generated within the cycle itself from the breakdown of ion exchange resins in the condensate polisher (if one is present) and from the decomposition of organic water treatment chemicals. Carbon dioxide enters through leakage of air into the condenser and low pressure turbine. Most experts regard carbon dioxide as nearly harmless to the turbine. The contribution of organic acids to turbine corrosion has not been established.

Figure 1 - Simplified water-steam cycle in a power plant showing the major ways contamination enters the system.

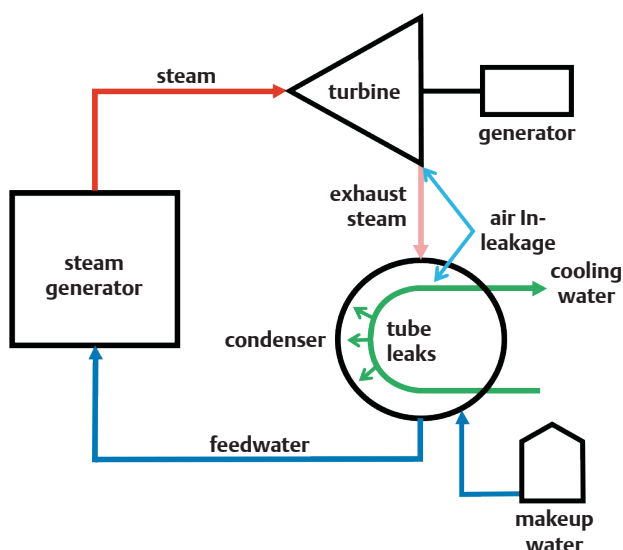

Once contaminants are in the system, they have the potential to enter the steam and be carried into the turbine. As long as the contamination is below a critical level, impurities remain in the steam and travel through the turbine without causing trouble. However, higher levels of impurities will precipitate on turbine surfaces causing efficiency-robbing scale and initiating mechanisms that can eventually lead to severe corrosion.

Keeping steam contamination at an acceptable level is a major objective of plant chemical control. The method of maintaining steam purity depends on the manner in which the steam is produced.

Plants with drum-type steam generators — both conventional boilers and heat recovery steam generators (HRSGs) — maintain steam purity by taking advantage of the physical separation that occurs between water and steam in the drum. As the water boils, it forms a steam-water mixture, which upon entering the drum separates into steam and water. Ideally, the impurities, carried with the feedwater into the boiler, remain with the water and only pure steam leaves the drum. In reality, the separation is not perfect. Small droplets of boiler water (mechanical carryover) and vaporized contaminants (vaporous carryover) are always present. Because carryover cannot be eliminated, the only way of controlling steam purity is to limit the amount of impurities in the boiler water. This is accomplished by blowing down the boiler when contamination gets too high. Both vaporous and mechanical carryover increase as drum pressure rises; therefore, the maximum allowed contamination in high pressure boilers is less than in low pressure boilers.

Table 1 - Conductivity of ammonia solutions containing small amounts of sodium chloride.

NH ₃ , ppm	Conductivity, uS/cm at 25 °C				
	0 ppb NaCl	1 ppb NaCl	2 ppb NaCl	5 ppb NaCl	10 ppb NaCl
0.2	2.21	2.21	2.21	2.22	2.23
0.3	2.99	2.99	2.99	3.00	3.01
0.4	3.67	3.67	3.67	3.68	3.69
0.5	4.28	4.28	4.28	4.29	4.30

Maintaining steam purity through phase separation is physically impossible in plants having supercritical steam generators. Because the pressure in the steam generator exceeds the critical value, water and steam cannot coexist, and the heated water becomes steam without going through a phase change. As a result, all the contaminants in the water entering the steam generator are carried with the steam into the turbine. To remove contaminants, supercritical plants rely on ion exchange demineralizers, called condensate polishers, installed at the condenser outlet.

Polishers contain a mixture of cation and anion exchange resins. Cation resin removes cationic contaminants, such as sodium. Anion resin removes anionic contaminants (chloride, sulfate, and carbonates) as well as silica. If properly operated and maintained, polishers can produce very high purity water resulting in very high purity steam. However, carelessly operated polishers can actually introduce contamination into the feedwater and, ultimately, the steam.

Over the years, turbine manufacturers and power industry research organizations have developed guidelines for acceptable steam purity. Current guidelines call for maintaining less than 2 ppb (ug/L) each of sodium, chloride, and sulfate and less than 10 ppb silica in the steam entering the turbine. It should be noted that although impurities are in the steam, they cannot be measured until the steam sample has been cooled and condensed. In addition to monitoring impurities in steam, it is common practice to test the boiler water and polisher effluent as well as the water leaving the condenser. The condenser is especially important because it is the point where contamination from tube leaks, air in-leakage, and poor quality makeup water enters the system. See Figure 1.

MEASURING CONTAMINATION USING CONDUCTIVITY

Contaminants are mostly ionic, which suggests that conductivity is a good way to detect them. Unfortunately, the increase in conductivity caused by even a moderate amount of contamination is difficult to detect because it is masked by background conductivity. Background conductivity arises from the ionization of weak bases, such as ammonia and morpholine, added to the condensate and feedwater to raise pH and control corrosion. Because these bases are volatile, they are also present in the steam.

Table 1 illustrates how background conductivity masks contamination. It shows the conductivity of ammonia solutions containing various amounts of sodium chloride. The ammonia concentrations are typical for plants having copper alloy feedwater heaters. Note that 10 ppb sodium chloride, corresponding to about 6 ppb chloride and 4 ppb sodium – well over the recommended limits – increases the conductivity by only about 0.02 uS/cm, an amount easily obscured by the background conductivity.

Although conductivity is not useful for measuring steam purity, it is very useful for controlling steam purity, at least in units with drum-type boilers. As noted previously, steam purity is maintained by limiting the concentration of impurities in the boiler water. Because the majority of these are ionic, conductivity is a convenient and inexpensive way of monitoring boiler water contamination. Blowdown limits are commonly based on conductivity.

MEASURING CONTAMINATION USING CATION CONDUCTIVITY

An instrument for removing background conductivity was developed in 1953 by T. E. Larson and R.W. Lane. The instrument is a column of hydrogen-form cation exchange resin, and the technique is called cation conductivity. See Figure 2.

Figure 2 - Instrumentation for measuring cation conductivity. Sensor 2 measures cation conductivity. Sensor 1 (optional) measures the conductivity from the treatment amine.

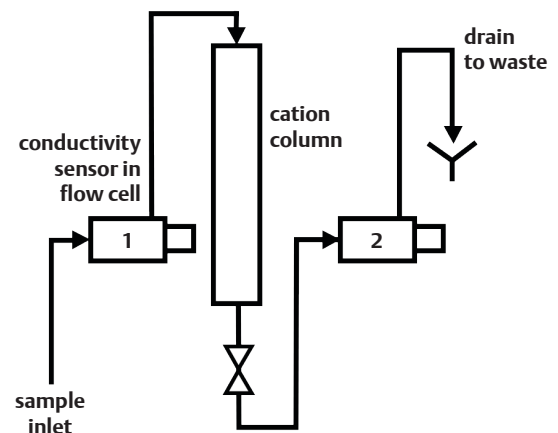
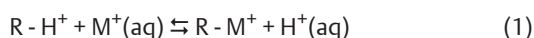

Table 2 - Conductivity of ammonia and sodium chloride solutions after passage through a hydrogen-form cation exchanger (cation conductivity).

NH ₃ , ppm	Cation conductivity, uS/cm at 25 °C				
	0 ppb NaCl	1 ppb NaCl	2 ppb NaCl	5 ppb NaCl	10 ppb NaCl
0.2	0.055	0.058	0.062	0.078	0.098
0.3	0.055	0.058	0.062	0.078	0.098
0.4	0.055	0.058	0.062	0.078	0.098
0.5	0.055	0.058	0.062	0.078	0.098

Cation Exchange

Cation exchange resin is a polymer in the form of small beads, roughly 0.5 to 1.0 mm in diameter. Negatively charged functional groups are chemically bonded to the polymer, and positively charged ions (cations) are attracted to each functional group. When placed in aqueous solution, the beads absorb water, providing a path for dissolved salts to diffuse into the bead. Inside the bead, cations in solution can exchange with cations at the functional groups. The process is called ion exchange and is summarized by equation 1.



In the equation, R is a functional group on the resin, and R-H⁺ means a hydrogen ion occupies it. In the language of ion exchange, the resin is in the hydrogen form. The designation (aq) for aqueous following the formula for the ion emphasizes that the ion is in solution, not on the resin. M⁺ is any cation other than H⁺.

Cation Conductivity

Cation resins are designed so that, with rare exceptions, any cation in solution will exchange with a hydrogen ion on the resin. The cations produced by the dissociation of the weak bases used for pH adjustment are no exception. Thus, cation resin removes the weak base and, along with it, the background conductivity.

Using ammonia (NH₃) as an example, the process can be imagined as occurring in three steps.

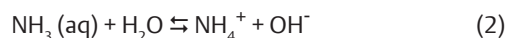

Equation 2 depicts the weak base reaction of ammonia with water to produce small amount of ammonium and hydroxide ions, i.e., the background conductivity. Equation 3 shows the ion exchange reaction in which ammonium (NH₄⁺) displaces a hydrogen ion from the resin. The loss of ammonium to the resin upsets the ammonia-water equilibrium (equation 2) causing more ammonium ions to form, which are also captured by the resin. Eventually, all the ammonia is converted to ammonium and held on the resin.

Equation 4 shows how each hydroxide ion (OH⁻) produced in reaction 2 is neutralized by the hydrogen ion released by ion exchange. The overall result is the complete removal of ammonia and its concomitant conductivity. The conductivity of the column effluent is, however, not zero. It still has a small amount of conductivity (0.055 uS/cm at 25 °C) from the slight dissociation of water into hydroxide and hydrogen ions. The background conductivity has not been completely removed, but it has been greatly reduced.

Now, consider what happens if a contaminant, for example sodium chloride, is present. Sodium chloride is completely dissociated into sodium and chloride ions. The resin removes the sodium, replacing it with a hydrogen ion and producing hydrochloric acid. (The chloride, being an anion, is unaffected.)



Thus, the resin converts ionic contaminants into the corresponding acid. The resulting conductivity is called cation conductivity. Because the method detects anions, not cations, many consider the term a misnomer, and prefer acid conductance or, better, conductivity after cation exchange (CACE).

Table 2 illustrates how cation conductivity is a better detector of contamination than conductivity. Not surprisingly, the cation conductivity from a given level of contamination is independent of the background ammonia concentration.

The Influence of Carbon Dioxide on Cation Conductivity

Carbon dioxide complicates the interpretation of cation conductivity measurements. Carbon dioxide, which enters the cycle as a gas, dissolves in the condensate and reacts with alkaline treatment chemicals to form carbonate salts, which upon passing through the cation exchanger, become carbonic acid, H₂CO₃. Aqueous solutions of carbonic acid are weakly ionized and contribute to the cation conductivity.

Using ammonia as the treatment chemical, the following equations illustrate the process.

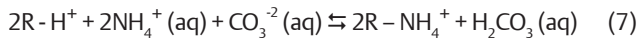
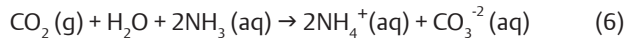

In equation 6 atmospheric carbon dioxide reacts with some of the ammonia in the condensate to form ammonium carbonate ($(\text{NH}_4)_2\text{CO}_3$). The sample passes through the cation column (equation 7), where ammonium ions exchange with hydrogen ions, and the liberated hydrogen ions combine with carbonate to form carbonic acid. As shown in equation 8, carbonic acid dissociates slightly to form hydrogen and bicarbonate ions (HCO_3^-), which contribute to the cation conductivity.

As Figure 3 shows, the contribution of even a small amount of carbon dioxide to the cation conductivity can be quite high. For example, 5 ppb increases the cation conductivity roughly 0.02 uS/cm. Put another way, 5 ppb of carbon dioxide, which has a conductivity of about 0.07 uS/cm at 25°C, is equivalent to the cation conductivity caused by about 4 ppb sodium chloride. (See the dotted line in Figure 3.)

Figure 3 - Conductivity of solutions of sodium chloride and carbon dioxide after passing through a hydrogen form cation exchanger.

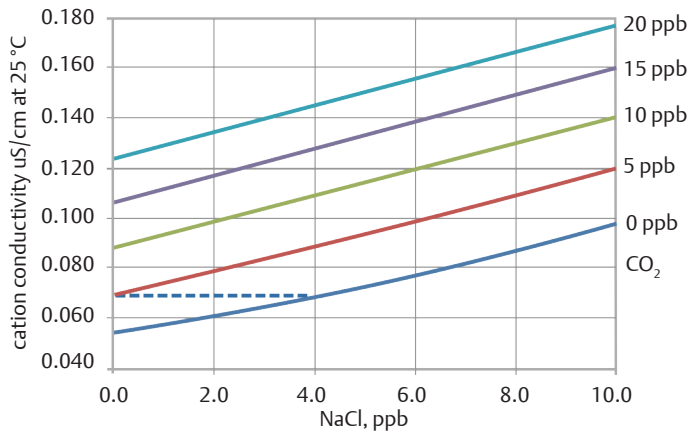

The Influence of Organic Acids on Cation Conductivity

Cation conductivity also detects organic acids, for example acetic and formic acid. Like carbon dioxide, organic acids are weak acids. The manner in which they react with the treatment amine and later reappear in the cation column effluent is analogous to the process described for carbon dioxide and ammonia. Figure 4 shows the effect of formic acid (HCOOH) on cation conductivity.

Figure 4 - Conductivity of solutions of sodium chloride and formic acid (HCOOH) after passing through a hydrogen-form cation exchanger.

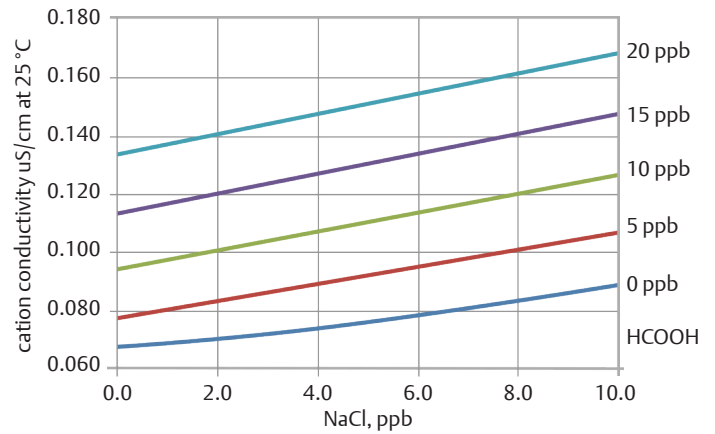

Practical Use of Cation Conductivity

Industry standards limit cation conductivity in steam to less than 0.35 uS/cm (at 25 °C) and in some cases to less than 0.10 uS/cm. Because 6 ppb of chloride – well in excess of the steam purity target – has a cation conductivity of 0.1 uS/cm, the limit clearly recognizes that less harmful contaminants, such as carbon dioxide and organic acids, are major contributors to cation conductivity.

In light of this, cation conductivity should be regarded not as an absolute measurement of contamination but as an indicator of potential degradation of steam purity. If a baseline cation conductivity, correlated with acceptable chloride and sulfate levels, can be established, any increase in cation conductivity must be regarded as sign of potential contamination. Whether the increase is truly caused by a rise in chloride and sulfate levels can be established only by laboratory testing.

In addition to steam, most plants measure cation conductivity at the condenser outlet. There are two benefits: continuous monitoring of minor baseline contamination and rapid notification when a large increase in contamination, requiring immediate attention, threatens steam purity. Because the condenser is upstream from the steam drum and polisher, the permitted cation conductivity at the condenser outlet is always greater than in the steam – 0.5 uS/cm is typical. The limit recognizes that much of the contamination is atmospheric carbon dioxide.

DEGASSED CATION CONDUCTIVITY

Recognizing the undesired effect of carbon dioxide on cation conductivity, Larsen and Lane proposed a method for removing it. The technique is called degassed cation conductivity. Figure 5 shows a typical apparatus. The sample first passes through the cation exchanger. Cation exchange leaves the water slightly acidic, so carbon dioxide is present mostly as the dissolved gas, although small amounts of carbonic acid and bicarbonate are also present.

From the cation exchanger the sample flows to the degasser (reboiler) where the temperature is raised to near the boiling point. High temperature reduces the solubility of carbon dioxide almost to zero, forcing it out of solution. Loss of carbon dioxide upsets the equilibrium between it, carbonic acid, and bicarbonate, causing the formation of more carbon dioxide, which is also driven out. Eventually, all the gas is expelled. Dissolved carbon dioxide can also be removed by sparging with nitrogen. Here the driving force is not heat, but the very low partial pressure of carbon dioxide in the scrubbing gas. Because the solubility of a gas depends on its partial pressure, reducing the partial pressure by sparging reduces the solubility.

Figure 5 - Method for measuring degassed cation conductivity. Conductivity sensor 1 measures cation conductivity. Conductivity sensor 2 measures degassed cation conductivity.

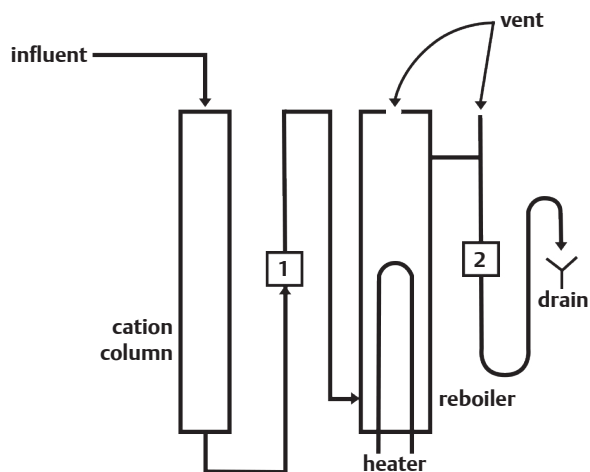

Although degassing removes carbon dioxide, it does not achieve the goal of allowing only the mineral acids derived from truly harmful contaminants, such as chloride and sulfate, to be measured. Volatile organic acids (if they were present at the start) will likely remain after degassing, although some quantity will be lost—in one study about 60%. Other studies have shown that degassing can also remove a small amount of hydrochloric and sulfuric acid. All in all, the interpretation of degassed cation conductivity can be challenging.

Degassing by heating the sample introduces another set of problems. The degassed conductivity is measured at high temperature, and incorrect temperature compensation can introduce significant errors.

TEMPERATURE COMPENSATION

Conductivity depends strongly on temperature. To allow measurements made at different temperatures to be compared, conductivity is corrected to the value at a reference temperature, typically 25°C. For most reasonably dilute neutral electrolyte solutions, conductivity changes about 2% per °C, so the temperature correction is fairly straightforward and, although not perfect, is

adequate for most applications. Cation conductivity is entirely different. A single temperature compensation factor is not adequate, and a more complicated correction must be used.

Although the details will not be given, the cation conductivity temperature correction assumes the sample is pure water contaminated with trace hydrochloric acid. As long as the dominant electrolyte is hydrochloric acid or another strong acid, such as sulfuric acid, the correction is quite good. Problems arise if other acids, for example carbonic acid, are present.

Figure 6 shows the percent error in the cation conductivity corrected to 25°C if the column effluent contains 5, 10, and 20 ppb of carbon dioxide in addition to the hydrochloric acid generated by 4 ppb of sodium chloride (1.6 ppb Na⁺ and 2.4 ppb Cl⁻).

As Figure 6 illustrates, temperature compensation errors caused by acids other than hydrochloric acid can be considerable. Because the amount and identity of the interfering acids cannot be predicted, customizing the temperature correction is not possible. The only way to minimize errors is to keep the temperature as close to 25°C as possible.

Figure 6 - Error in the corrected cation conductivity for samples containing various amounts of carbon dioxide. In each case, the sample entering the column contains 4 ppb of sodium chloride.

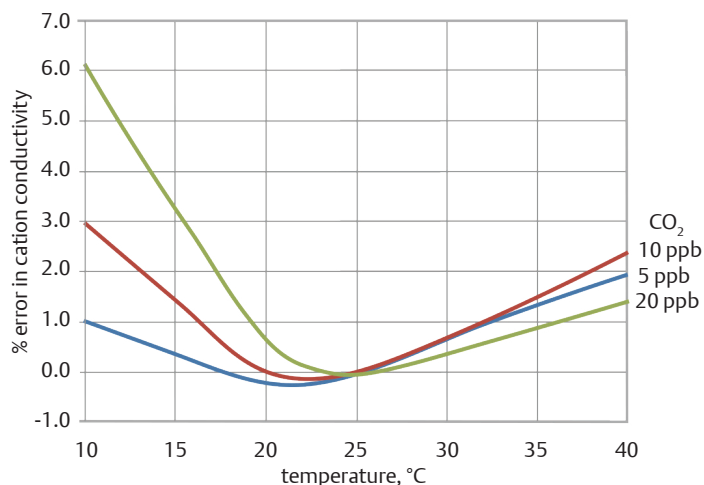

Temperature compensation errors are particularly serious in the measurement degassed cation conductivity where carbon dioxide is removed by boiling. Not only can the degassed sample contain trace organic acids, which the cation conductivity correction model does not account for, but also the temperature is high, which makes the error even worse. To reduce temperature compensation errors, some instruments incorporate coolers to reduce the temperature of the degassed sample before it reaches the conductivity sensor.

INSTRUMENTATION

Instrumentation for measuring cation conductivity is fairly simple. See Figure 1. The heart, of course, is the cation column. The column is typically a 2 or 2½ inch ID transparent plastic tube fitted with inlet and outlet connections and holding roughly 500 mL of resin. The resin bed rests on a screen that prevents resin fines from becoming trapped in the downstream conductivity sensor.

The resin does not have unlimited capacity to exchange hydrogen ions for cations. At some point, it will run out of hydrogen. When this happens, the resin — said to be exhausted — no longer removes background conductivity, and the conductivity of the water leaving the column increases, giving a false indication of contamination. To help the user judge when the column needs replacement, resin dyed with a pH indicator is often used. The dye is brown when the surrounding water is alkaline and purple when it is acidic. A resin column exhausts by layers in the direction of flow, typically from top to bottom. Once a layer of resin at the top of the column is exhausted, the surrounding water is alkaline (from the amine), and the dye is brown. The resin below the exhausted layer is bathed in slightly acidic water (from ion exchange of the contaminant) and remains purple. Over time, the brown band grows and the purple band shrinks. Normal practice is to keep the column in service until ½ inch (10 mm) or so of purple resin remains at the bottom.

The operating life of the column depends on the flow and concentration of the treatment chemical. For a sample containing 0.28 ppm ammonia (pH 9.0) at the recommended flow of 250 mL/min, 500 mL of resin lasts about six months. More ammonia leads to faster exhaustion; 0.50 ppm ammonia (pH 9.2) will exhaust the resin in slightly more than three months.

Because the conductivity is low, a contacting sensor with a 0.01/cm cell constant is ideal for measuring both cation conductivity and the inlet conductivity (see Figure 1). Either a 400-11 sensor screwed into a pipe tee (which serves as the flow cell) or a 404-11 sensor is suitable. The 404 sensor combines the electrodes and the flow cell into a single body. The 404 sensor is available with either a PVC (404-16) or stainless steel body (404-17). The 404-17 can be disassembled for cleaning, whereas the 404-16 cannot. If only cation conductivity is to be measured, the less expensive PVC body is a good choice because the resin bed filters out suspended corrosion products, protecting the downstream sensor from fouling. If conductivity is to be measured upstream of the cation column, an easier to clean sensor is recommended. The stainless steel body 404 sensor must be used to measure degassed cation conductivity if heat is used for degassing and the sample is not cooled before measurement.

Any Rosemount 4-wire or 2-wire conductivity analyzer can be used for the measurement. Because they accept two inputs, the 1056 and 56 analyzers are particularly convenient if both conductivity and cation conductivity are being measured. The two channels are completely independent, so the temperature compensation appropriate to the channel, linear slope or cation, can be assigned. For most water treatment amines a slope of 2.0% per °C between 5 and 40°C is adequate.

ANALYZERS AND SENSORS

1056 Dual Input Analyzer

- Single or dual input allows both conductivity and cation conductivity to be measured. Channels are completely independent.
- Bright, large display shows results for both channels.
- Easy-to-use menu guides the user through setup and calibration.



56 Advanced Dual Input Analyzer

- Single or dual input allows both conductivity and cation conductivity to be measured. Channels are completely independent.
- Full color display shows results for both channels.
- Full text menus guide the user through configuration and calibration. Information screens, available at the touch of a button provide additional information and troubleshooting.
- Downloadable data and event loggers are available as well as a graphical display.



400 Conductivity Sensors

- Initial calibration not required. Factory measured cell constant ensures out-of-box accuracy.
- Rugged titanium electrodes and stainless steel process connection ensures long life.
- Sensors are available with integral cable or quick disconnect fittings.



404 Low Flow Conductivity Sensors

- Electrodes and flow cell combined in a single body makes installation easy.
- Small holdup volume enables fast response to conductivity changes.
- Initial calibration not required. Factory measured cell constant ensures out-of-box accuracy.



Notes

EmersonProcess.com/LiquidAnalysis



YouTube.com/user/RosemountAnalytical



Analyticexpert.com



Twitter.com/Rosemount_News



Facebook.com/Rosemount

©2016 Emerson Process Management. All rights reserved.

Emerson Process Management

2400 Barranca Parkway
Irvine, CA 92606

USA

Toll Free + 800 854 8257

T + 949 757 8500

F + 949 474 7250

Liquid.CSC@Emerson.com

The Emerson logo is a trademark and service mark of Emerson Electric Co. Rosemount and the Rosemount logotype are registered trademarks of Rosemount Inc. All other marks are the property of their respective owners.

The contents of this publication are presented for information purposes only, and while effort has been made to ensure their accuracy, they are not to be construed as warranties or guarantees, express or implied, regarding the products or services described herein or their use or applicability. All sales are governed by our terms and conditions, which are available on request. We reserve the right to modify or improve the designs or specifications of our products at any time without notice.

ROSEMOUNT™

