

Uncover actionable insights that drive operational improvement



Industrial Internet of Things (IIoT) Applied Solutions

Discover how digital transformation can turn real-time data into increased efficiency and reduce operating cost.



Operational challenges



Global competition requires manufacturers to strive for operational excellence to ensure they are competitive and profitable. This requires continuous improvements in terms of greater reliability, reduced unscheduled downtime due to equipment failures, lower maintenance costs, extended equipment life, optimised energy consumption, improved sustainability and greater throughput.

Manufactures often operate with little information about the health and performance of devices and machines. This can create a trial and error approach to troubleshooting, leading to excessive downtime, higher maintenance costs and lower efficiency. Manufacturers are increasingly looking to digitally transform their operations, changing from manual-based work practices to automated, digital, software-based and data-driven ways of working.

IIoT applications are enabling companies to leverage technology and expertise to digitally transform operations. A wealth of useful data is trapped inside devices, equipment and machines. IIoT technologies presents an opportunity to gain easier and faster access to actionable information that supports better decision making and operational performance.

A lack of actionable information prevents performance improvements in the domains of reliability, sustainability, productivity and safety. Below are examples of typical operational challenges we can assist with.



	<p style="text-align: center;">Predictive Maintenance</p> <ul style="list-style-type: none">• Machines and devices offer no condition monitoring, leading to unexpected downtime• Unable to identify problematic devices and schedule maintenance
	<p style="text-align: center;">Sustainability</p> <ul style="list-style-type: none">• Machine performance is not monitored leading to higher energy consumption• Losses and leaks go undetected leading to wasted energy• Undetected issues create late stage quality issues leading to scrappage and material waste



Productivity Improvements

- Critical parameters required to optimise machine performance are not measured
- Unplanned downtime reduces equipment availability and productivity



Safety

- Additional components, costs and complexity required to improve safety
- Greater complexity compromises productivity

IloT opportunities

IloT creates an opportunity to revolutionise manufacturing operations by enabling the acquisition and accessibility of greater amounts of data, at far greater speeds. But obtaining additional data from the plant floor through a broad range of sensors is just the start. You must be able to turn raw data into information that can produce actionable insights that enhance operations. But in order to do that, you first must:

- Develop a clear definition of the problem and scale
- Understand the current sources of data and potential missing data
- Create the plan for how information will be collected and transferred to action
- Calculate the return on investment (ROI) for your IloT application





For many manufacturers there is still not a clear understanding of how the IloT will create quantifiable improvements for their business. Investments in digitalisation and IloT technology can be significant, but whatever the size of capital expenditure, it is important to consider the ROI. Some application examples:

- An ice cream manufacturer made a one-off investment on technology that enabled them to analyse machine performance, identify leakages, and prevent unplanned downtime. This investment helped them to improve Overall Equipment Effectiveness (OEE) and increase machine production significantly, with a ROI of less than three months
- A global manufacturer invested in a solution that provided predictive maintenance to prevent replacement of costly cylinders. This not only reduced machine downtime and labour costs, but also saved the manufacturer expensive part replacements. The ROI was one year

To identify IloT opportunities in your organisation, areas such as the automation architecture, machine control systems, SCADA, safety systems, PLCs, networking technology, sensors, machinery health monitoring and instrumentation should be reviewed.

IloT applications

Emerson has been applying IloT technology for several years. Our experts understand your industry and application requirements. They are experienced in identifying opportunities to implement IloT solutions that will provide the performance gains you need. Here are some examples of how we have helped our customers to implement IloT on key applications that have created significant benefits.

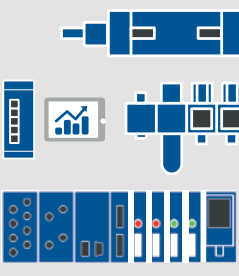
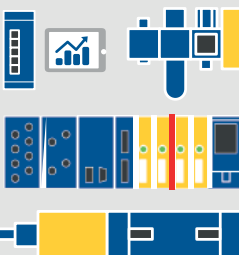
Industry Example	Challenge	Solution	Opportunity	Benefit
Factory Automation	Frequent replacement of rodless cylinders resulting in costly downtime and losses		Monitor health status with simple two-position sensors to measure movement and damping speed of shock absorbers	<ul style="list-style-type: none"> Predict failures of cylinders and components before they happen Reduce unexpected downtime events that cost production
Food & Beverage	High compressed air and steam consumption and low energy efficiency		Monitor air and steam flow and pressure profile, and other parameters to determine the causes such as waste or leaks	<ul style="list-style-type: none"> Reduced pneumatic air consumption and improved energy efficiency
Tyre Manufacturing	Increased machine cycle time is reducing throughput		Monitor machine component cycle time and key parameters such as steam temperature, pressure and flow to determine the cause of increased cycle time	<ul style="list-style-type: none"> Able to make informed decisions to improve Overall Equipment Effectiveness (OEE)
Automotive	Increasing machine safety adds complexity and reduces productivity		Isolate three safety zones from a single valve system, reducing complexity and components, and analyse production data to confirm any compromise	<ul style="list-style-type: none"> Increased safety without compromising machine productivity

Industrial automation and machine control capabilities

Integrated solutions including IIoT applications from a single automation provider help to simplify the design, commissioning, procurement, and lifecycle management, leading to lower costs and greater operational efficiency. Emerson is the leading industrial automation company that offers a complete machine automation and control portfolio including intelligent sensors and devices, control systems and HMI/SCADA, fluid control and pneumatics, motion controllers, safety systems, wired and wireless network devices, and more.

SYSTEM ARCHITECTURE

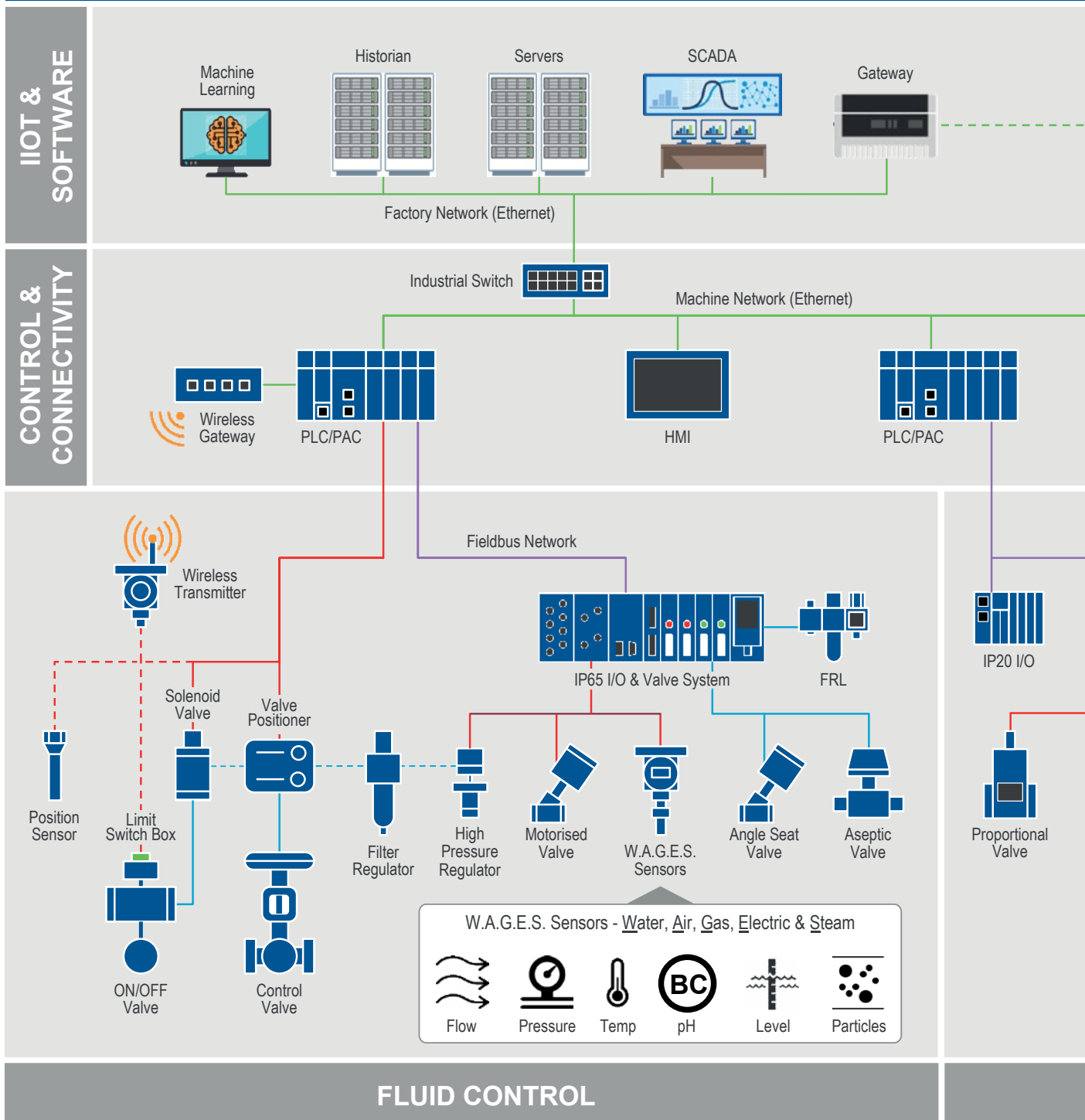

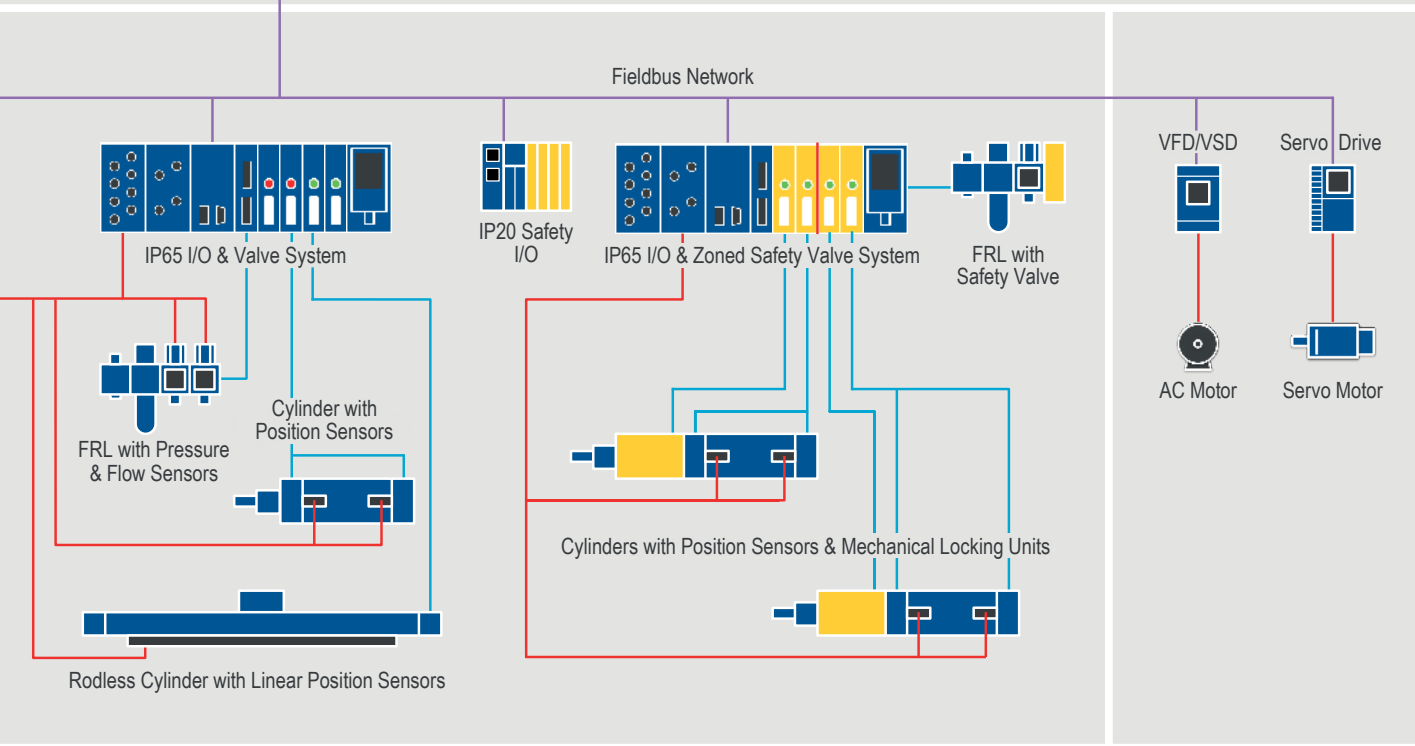
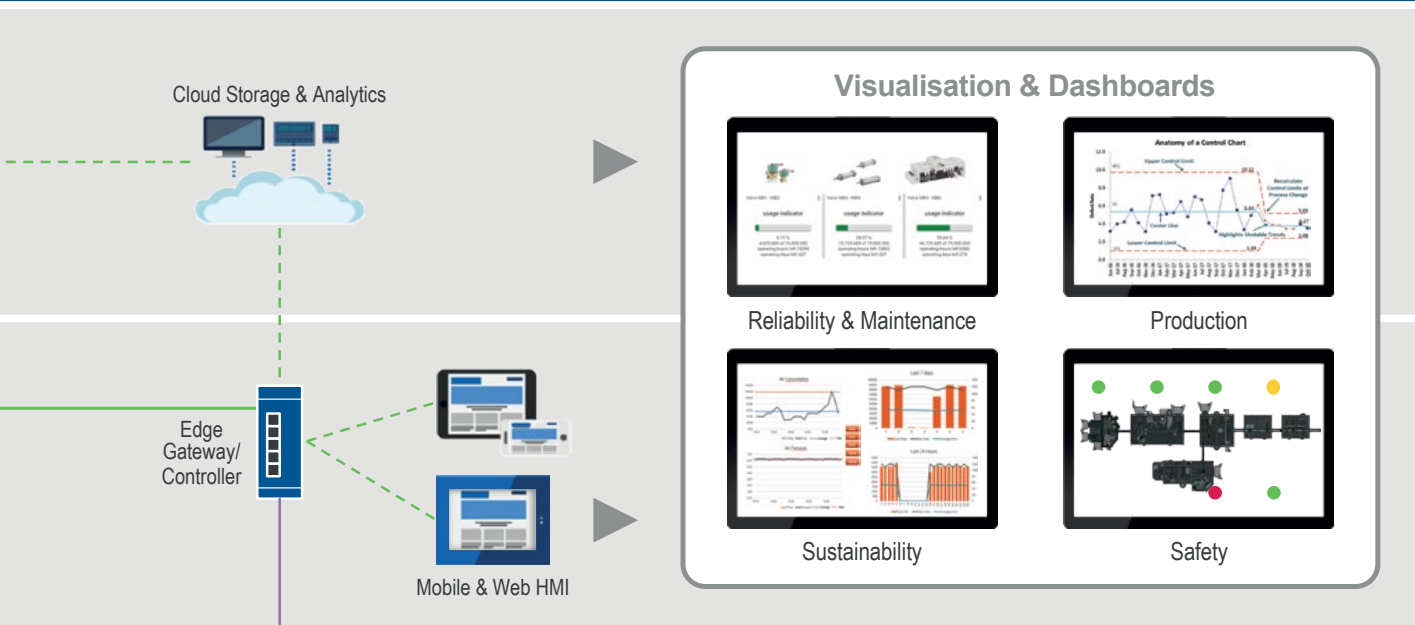

PNEUMATICS

MOTION CONTROL

Register for your IIoT Introductory Session today



Schedule an IIoT Introductory Session to learn how to reduce machinery downtime, increase equipment reliability, enhance safety, make energy efficiency savings and improve production efficiency.

Emerson IIoT Introductory Sessions provide the opportunity to learn how to build successful IIoT strategies, turn actionable insights into operational improvements and calculate a return on your IIoT investment.

Sign up here: go.emersonautomation.com/IIoT-introductory-sessions

Your local contact: Emerson.com/contactus



Emerson.com



Facebook.com/EmersonAutomationSolutions



LinkedIn.com/company/Emerson-Automation-Solutions



Twitter.com/EMR_Automation

The Emerson logo is a trademark and service mark of Emerson Electric Co. All other marks are the property of their respective owners. © 2020 Emerson Electric Co. All rights reserved. BR000004ENGB-01_02-20 / Printed in Europe



CONSIDER IT SOLVED™