



LIGHTING CATALOG

APPLETON'S LINE OF LIGHTING PRODUCTS DELIVERS UNPARALLELED PROTECTION.

Light fixtures that work flawlessly and stand up to harsh conditions go unnoticed everyday, which is exactly the point. Appleton luminaires are designed to withstand the harshest conditions and operate across your facility without incident. A century of innovation and testing makes sure of that. From area to task, flood to emergency, we have a light fixture perfectly suited for every task and use in environments that are hazardous, adverse or ordinary. After all, our vast collection of fixtures is unsurpassed in the industry. Appleton has expanded the boundaries of technology, efficiency and performance to ensure your lights stays on, because failure is not an option.

Notes

Lighting

Table of Contents

Description	Page
Table of Contents	iii
Product Safety Statement	iv
Alphanumeric Index	v
Complete Lighting Index	1
LED Luminaires	8
Induction Luminaires	165
HID Luminaires	178
Fluorescent Luminaires	455
Visual Signal	569
Labels for ATEX/IECEX Emergency Lighting Units	594
Incandescent	595
Photocontrols	677
Poles and Hangers	680
General Lighting	717

Product Safety Statement

The information contained in this catalog is based on our experience to date and is believed to be reliable. All weights and dimensions are approximate. This catalog supersedes and voids all previous literature.

Information in this catalog is subject to change without notice. At times, it may be necessary to modify the materials, finishes, or other components of the product. These modifications will meet or exceed the performance or functional requirements of the product.

Appleton Group designs and manufactures a range of electrical products that meet the electrical codes of different geographic markets. Many of these products are evaluated by internationally recognized third-party product safety testing and certification agencies.

As a safety precaution, users of these products must verify the product is appropriate for their application by consulting the electrical code and safety standards for their area.

Appleton Group products should be installed in accordance with the installation instructions provided with the product and all applicable electrical codes. Additional safety requirements are indicated by appropriate Danger, Warning and Caution statements which follow the suggested format of the American National Standards Institute (ANSI).

These statements are intended to inform not only knowledgeable, sophisticated installers and users, but also those who will have casual contact with the product. Failure to follow this information could result in serious personal injury. Where appropriate these statements may appear on:

1. The product carton
2. The label attached to the product carton
3. The instruction sheet
4. The product itself in a conspicuous manner where physical space allows

Any questions with regard these statements or safety should be addressed to:

Product Safety Officer
Appleton Group
9377 W. Higgins Road
Rosemont, IL 60018
1-800-621-1506
www.emerson.com

Alphanumeric Index

Catalog Number	Page	Catalog Number	Page	Catalog Number	Page	Catalog Number	Page
00868	725	1435-6	739	2262-Y	745	5213-6660	737
0134CP	747	1435-6	748	2263	744	5227-0001	735
0134CS	747	1438	748	2263-B	745	5227-0002	736
01540	740	1438-1	748	2263-G	745	5227-0003	733
0603AS	747	1455-38	723	2263-P	745	5227-0004	734
0603CS	747	1455-38-T	723	2263-R	745	5227-0005	735
0603GS	747	1500-C	747	2263-Y	745	5227-0006	733
0603RS	747	150-CA	741	2265	745	5227-0007	733
0604AP	747	151-CA	741	2268	744	5227-0008	733
0604AS	747	152-C	741	2269	744	5227-9915	735
0604CP	747	153-C	741	2270	744	5227-9916	735
0604CS	747	154-C	741	2271	744	5274-1743	740
0604GP	747	155-C	741	2272	744	5329-0003	732
0604GS	747	156-C	741	2273	744	5329-0015	731
0604RP	747	157-C	742	2273-B	745	5329-0015	732
0604RS	747	158-C	741	2273-G	745	5329-4000	731
0752-C	747	159-C	741	2273-P	745	5329-4001	731
0752-P	747	160-P	743	2273-R	745	5329-4002	731
0753	737	161-C	741	2273-Y	745	5329-4003	731
0753	739	162-C	742	2274	745	5329-4004	731
0753-HR	739	163-C	741	2276	744	5329-4010	731
08162	721	166-C	742	2278	744	5329-4011	731
08162	722	170-P	740	2279	745	5329-4012	731
08170	721	171-C	740	2285	745	5329-7000	732
08170	722	173-S	740	2286	744	5329-7010	732
08170	725	174	740	2295	744	5330-0401	730
08171	721	184	740	2295-B	745	5330-0411	730
08171	722	200	743	2295-G	745	5330-0418	730
08171	725	2100-2100-A	748	2295-P	745	5330-0800	730
08336	721	2200-2200-A	748	2295-R	745	5330-0811	730
08336	722	2250-S	719	2295-Y	745	5330-0818	730
0877	725	2251	719	2508	745	5330-1500	730
0877-N	725	2252	719	2522	744	5330-1501	730
094784	584	2252-0035	719	2534	744	5330-1525	730
094784	643	2252-0038	719	2546	744	5330-1550	730
094904	594	2252-0040	719	2932	748	5331-0001	726
094905	594	2252-0041	719	2933	748	5331-0002	726
094906	594	2252-0043	719	3316	747	5331-0002	727
094907	594	2252-0044	719	4014	747	5331-0002	728
094908	594	2252-1025	719	4015	721	5331-0003	728
094909	594	2253	719	4015	722	5331-0004	728
094910	594	2254	719	4018	719	5331-0005	729
094911	594	2255	719	5000-G	725	5331-0006	729
094912	594	2256	719	5000-GN	725	5331-0007	729
094913	594	2259	719	5000-RG	725	5331-0008	726
094914	594	2260	744	5000-RGN	725	5331-0008	727
094915	594	2260-B	745	5025-G	725	5331-0008	728
094916	594	2260-G	745	5025-GN	725	5331-0032	727
094917	594	2260-P	745	5025-RG	725	5331-0033	727
094918	594	2260-R	745	5025-RGN	725	5331-0034	727
094919	594	2260-Y	745	5050-G	725	5331-0035	726
096905	559	2261	744	5050-GN	725	5331-0035	727
0BV1	608	2261-B	745	5050-RG	725	5331-0036	727
0BVW1	608	2261-G	745	5050-RGN	725	5332-0818	730
11355	702	2261-P	745	5213-0623	739	5332-0825	730
11360	702	2261-R	745	5213-0637	739	5332-1525	730
11362	702	2261-Y	745	5213-0638	739	5999-GH	725
1433	748	2262	744	5213-0672	739	5999-RGH	725
1434	748	2262-B	745	5213-6623	737	600	739
1435-1	748	2262-G	745	5213-6625	737	600-3	739
1435-3	748	2262-P	745	5213-6649	737	600-FL22	737
1435-6	737	2262-R	745	5213-6659	737	601	739

Alphanumeric Index

Catalog Number	Page	Catalog Number	Page	Catalog Number	Page	Catalog Number	Page
6012-SRG	724	7050-G-38-200	723	AAN-150	625	AC2075	623
601-FL22	737	7050-RG	721	AAP-100	625	AC-KT	682
6025-SRG	724	7050-RIG	721	AAP-50	625	AEXR-15R	369
6025-SRG-GFCI	724	737DM3T25	113	AAP-50	631	AEXR-15R	501
603	739	7925-RGH	721	AAP-75	625	AEXR-15R	512
604	739	7950-RGH	721	AAP-75	631	AEXR-15R	624
605	739	7999-RGH	721	AAPA1550	630	AF-EXL	418
6050-SRG	724	8133	721	AAPA1575	630	AF-JB	418
605-FL22	737	8133	722	AAPA2050	630	AF-SF	418
606	739	8162	721	AAPA2075	630	AH260-347	519
606-3	739	8162	722	AARP-2AN	626	AH260-BU	519
606-FL22	737	8170	721	AARP-2AN	630	AH360-347	519
610	739	8170	722	AARP-2ST	626	AH360-BU	519
611	739	8170	725	AARP-2ST	630	AH460-347	519
6229-1	723	8171	721	AARW15AN	512	AH460-BU	519
6229-1	725	8171	722	AARW-15AN	626	AHG5050	694
6229-1	721	8171	725	AARW-15AN	630	AHG7550	694
6229-2	723	8224	721	AARW15ST	512	AHG7575	694
6229-2	725	8224	722	AARW-15ST	626	AHL100	669
6229-2	721	8224	725	AARW-15ST	630	AHL200	669
640	739	8335-2	721	AARW-2AN	626	ALA50	698
6403	721	8335-2	722	AARW-2AN	630	ALA50-12	696
6403	722	8336	721	AARW-2ST	626	ALA50-120	696
6403	723	8336	722	AARW-2ST	630	ALA50-48	696
640-FL22	737	8436R	703	AASB-50	625	ALA50-B	696
641	739	8438R	703	AASB-50	631	ALA75	698
641-FL22	737	8456R	703	AASB-75	625	ALA7550-B	696
643	739	8458R	703	AASB-75	631	ALA7575-12	696
644	739	8959	721	AASBA1550	630	ALA7575-120	696
645-FL22	737	8959	722	AASBA1575	630	ALA7575-48	696
6461	732	8959	723	AASBA2050	630	ALA75-B	696
646-FL22	737	9232	721	AASBA2075	630	ALB10100	624
649	739	9232	722	AASP-11	626	ALB1050	624
650	739	9260	743	AASP-15A	626	ALB1050-1812	511
650-FL22	737	9995	748	AASP-15V	626	ALB1050-186	511
651	739	AAC-100	625	AASP-22	626	ALB1050-2812	511
651-FL22	737	AAC-50	625	AASP-2A	626	ALB1050-286	511
653	739	AAC-50	631	AASP-2V	626	ALB1075	624
654	739	AAC-75	625	AASP-44	626	ALB15100	624
655-FL22	737	AAC-75	631	AASPA-15	631	ALB1550	624
656-FL22	737	AACA1550	630	AASPA-22	631	ALB1575	624
659	739	AACA1575	630	AAU-15N	625	ALB20100	624
669	739	AACA2050	630	AAU-1N	625	ALB2050	624
7000-G	721	AACA2075	630	AAU1N-1812	511	ALB2075	624
7000-G-38	723	AAGL-1A	626	AAU1N-186	511	ALC100	698
7000-G-38-200	723	AAGL-1G	626	AAU1N-2812	511	ALC1050-B	696
7000-RG	721	AAGL-1PR	625	AAU1N-286	511	ALC1075-12	696
7000-RIG	721	AAGL-1R	626	AAU-2NS	625	ALC1075-120	696
7001-G	721	AAGL-2A	626	AAUA-15	631	ALC1075-48	696
7001-RG	721	AAGL-2G	626	AAUA-2	631	ALC1075-B	696
7002-G	721	AAGL-2PR	625	AC10100	623	ALC50	698
7002-RG	721	AAGL-2R	626	AC1050	623	ALC50-12	696
7013	743	AAGLA-15	631	AC1050-1812	511	ALC50-120	696
7014	743	AAGLA-2	631	AC1050-186	511	ALC50-48	696
7019	743	AAGU-1	512	AC1050-2812	511	ALC50-B	696
7025-G	721	AAGU-1	625	AC1050-286	511	ALC75	698
7025-G-38	723	AAGU-2	625	AC1075	623	ALC7550-B	696
7025-G-38-200	723	AAGU-2	631	AC15100	623	ALC7575-12	696
7025-RG	721	AAGUA-15	631	AC1550	623	ALC7575-120	696
7025-RIG	721	AALB-100	625	AC1575	623	ALC7575-48	696
7050-G	721	AALB-50	625	AC20100	623	ALC75-B	696
7050-G-38	723	AALB-75	625	AC2050	623	ALL50	698

Alphanumeric Index

Catalog Number	Page	Catalog Number	Page	Catalog Number	Page	Catalog Number	Page
ALL50-12	697	AP1050-286-DM	510	BKXD-32	681	C641-FL22	737
ALL50-120	697	AP1075	623	BKXD-32A	681	C643	739
ALL50-48	697	AP15100	623	BKXD-3A	681	C644	739
ALL50-B	697	AP1550	623	BKXM-1	681	C645-FL22	737
ALL75	698	AP1575	623	BKXM-11	681	C646-FL22	737
ALL7550-B	697	AP20100	623	BKXM-11A	681	C650	739
ALL7575-12	697	AP2050	623	BKXM-1A	681	C650-FL22	737
ALL7575-120	697	AP2075	623	BKXM-2	681	C651	739
ALL7575-48	697	APL240347	515	BKXM-21	681	C651-FL22	737
ALL75-B	697	APL240BU	515	BKXM-21A	681	C653	739
ALT100	698	APL2GUSS	515	BKXM-22	681	C654	739
ALT1050-B	697	APL2R	515	BKXM-22A	681	C655-FL22	737
ALT1075-12	697	APL2R	523	BKXM-2A	681	C656-FL22	737
ALT1075-120	697	APL440347	515	BKXM-3	681	C7000-G	722
ALT1075-48	697	APL440BU	515	BKXM-31	681	C7000-G-38	723
ALT1075-B	697	APL4R	515	BKXM-31A	681	C7000-RG	722
ALT50	698	APL4R	523	BKXM-32	681	C7000-RIG	722
ALT50-12	697	APLEXR	515	BKXM-32A	681	C7001-G	722
ALT50-120	697	ARS232-347	519	BKXM-3A	681	C7001-RG	722
ALT50-48	697	ARS232-BU	519	BKXS-1	681	C7002-G	722
ALT50-B	697	ARS240-347	519	BKXS-11	681	C7002-RG	722
ALT75	698	ARS240-BU	519	BKXS-11A	681	C7025-G	722
ALT7550-B	697	ARS332-347	519	BKXS-1A	681	C7025-G-38	723
ALT7575-12	697	ARS332-BU	519	BKXS-2	681	C7025-RG	722
ALT7575-120	697	ARS340-347	519	BKXS-21	681	C7025-RIG	722
ALT7575-48	697	ARS340-BU	519	BKXS-21A	681	C7050-G	722
ALT75-B	697	ARS432-347	519	BKXS-22	681	C7050-G-38	723
AMLED67AW	140	ARS432-BU	519	BKXS-22A	681	C7050-RG	722
AMLED67YBH	139	ARS440-347	519	BKXS-2A	681	C7050-RIG	722
AMLED67YBU1	139	ARS440-BU	519	BMMLLED	99	C7925-RGH	722
AMLED774BU1GR	153	ARSGUSS	515	BPLLED	99	C7950-RGH	722
AMLED77AW	140	ASB1050	624	C5000-G	725	C7999-RGH	722
AMLED77DBH	140	ASB1050-1812	511	C5000-GN	725	CAC-100	80
AMLED77DBU	140	ASB1050-186	511	C5000-RG	725	CAC-100	490
AMLED77YBC	139	ASB1050-2812	511	C5000-RGN	725	CAC-100	500
AMLED77YBH	139	ASB1050-286	511	C5025-G	725	CAC-100	617
AMLED77YBU1	139	ASB1075	624	C5025-GN	725	CAC-100	354
AMLED87AW	140	ASB1550	624	C5025-RG	725	CAC-100	368
AMLED87DBHL	140	ASB1575	624	C5025-RGN	725	CAC-75	579
AMLED87DBHR	140	ASB2050	624	C5050-G	725	CAC-75	617
AMLED87YBH	139	ASB2075	624	C5050-GN	725	CAC-75	80
AMLED87YBU1	139	AVH210-118	519	C5050-RG	725	CAC-75	354
AMLEDCM	140	AVH210-277	519	C5050-RGN	725	CAC-75	368
AMLEDCM	147	AVH210-347	519	C5999-GH	725	CAC-75	490
AMLEDDBU1L	140	AVH410-118	519	C600	739	CAC-75	500
AMLEDDBU1R	140	AVH410-277	519	C600-FL22	737	CAC-751971	580
AMLEDMDOOR	140	AVH410-347	519	C601	739	CALB-100	80
AMLEDMDOORP	140	BJ50	698	C6012-SRG	724	CALB-100	354
AMLEDSF1	140	BJ75	698	C601-FL22	737	CALB-100	368
AMLEDSF1	147	BKXD-1	681	C6025-SRG	724	CALB-100	490
AN10150	623	BKXD-11	681	C603	739	CALB-100	500
AN15150	623	BKXD-11A	681	C604	739	CALB-100	617
AN20150	623	BKXD-1A	681	C605	739	CALB-75	579
AP10100	623	BKXD-2	681	C6050-SRG	724	CALB-75	617
AP1050	623	BKXD-21	681	C605-FL22	737	CALB-75	80
AP1050-1812	511	BKXD-21A	681	C606	739	CALB-75	354
AP1050-1812-DM	510	BKXD-22	681	C606-FL22	737	CALB-75	368
AP1050-186	511	BKXD-22A	681	C6229-1	722	CALB-75	490
AP1050-186-DM	510	BKXD-2A	681	C6229-2	722	CALB-75	500
AP1050-2812	511	BKXD-3	681	C640	739	CALB-751971	580
AP1050-2812-DM	510	BKXD-31	681	C640-FL22	737	CAP-100	80
AP1050-286	511	BKXD-31A	681	C641	739	CAP-100	354

Alphanumeric Index

Catalog Number	Page
CAP-100	368
CAP-100	490
CAP-100	500
CAP-100	617
CAP-75	579
CAP-75	617
CAP-75	80
CAP-75	354
CAP-75	368
CAP-75	490
CAP-75	500
CAP-751971	580
CAP-75B	80
CAP-75B	365
CAP-75B	498
CAS-150	80
CAS-150	354
CAS-150	368
CAS-150	490
CAS-150	500
CAS-150	617
CAS-150B	80
CAS-150B	365
CAS-150B	498
CB202	691
CB202	698
CB205	685
CB205CN	685
CBK-1G	681
CBK-1GA	681
CBK-2G	681
CBK-2GA	681
CFB5210A5	499
CFB5210BU	499
CFB5275A5	499
CFB5275BU	499
CFB6410A5	499
CFB6410BU	499
CFB6475A5	499
CFB6475BU	499
CFB8410A5	499
CFB8410BU	499
CFB8475A5	499
CFB8475BU	499
CFBS5210	489
CFBS5275	489
CFBS6410	489
CFBS6475	489
CFBS8410	489
CFBS8475	489
CFC5210A5	499
CFC5210BU	499
CFC5275A5	499
CFC5275BU	499
CFC6410A5	499
CFC6410BU	499
CFC6475A5	499
CFC6475BU	499
CFC8410A5	499
CFC8410BU	499
CFC8475A5	499
CFC8475BU	499

Catalog Number	Page
CFC5210	489
CFC5275	489
CFC6410	489
CFC6475	489
CFC8410	489
CFC8475	489
CFH175CATTN	417
CFH175JBTTN	417
CFH175SFTTN	417
CFH175TTN	417
CFH250CATTN	417
CFH250JBTTN	417
CFH250SFTTN	417
CFH250TTN	417
CFH400CATTN	417
CFH400JBTTN	417
CFH400SFTTN	417
CFH400TTN	417
CFL150CAMT	416
CFL150CATTN	417
CFL150JBMT	416
CFL150JBTTN	417
CFL150MT	416
CFL150SFMT	416
CFL150SFTTN	417
CFL150TTN	417
CFL250CAMT	416
CFL250CATTN	417
CFL250JBMT	416
CFL250JBTTN	417
CFL250MT	416
CFL250SFMT	416
CFL250SFTTN	417
CFL250TTN	417
CFL400CAMT	416
CFL400CATTN	417
CFL400JBMT	416
CFL400JBTTN	417
CFL400MT	416
CFL400SFMT	416
CFL400SFTTN	417
CFL400TTN	417
CFF150CAMT	416
CFF150CATTN	417
CFF150JBMT	416
CFF150JBTTN	417
CFF150MT	416
CFF150SFMT	416
CFF150SFTTN	417
CFF150TTN	417
CFF175CAMT	416
CFF175CATTN	417
CFF175JBMT	416
CFF175JBTTN	417
CFF175MT	416
CFF175SFMT	416
CFF175SFTTN	417
CFF175TTN	417
CFF250CAMT	416
CFF250CATTN	417
CFF250JBMT	416
CFF250JBTTN	417

Catalog Number	Page
CFP250MT	416
CFP250SFMT	416
CFP250SFTTN	417
CFP250TTN	417
CFP320CAMT	416
CFP320CATTN	417
CFP320JBMT	416
CFP320JBTTN	417
CFP320MT	416
CFP320SFMT	416
CFP320SFTTN	417
CFP320TTN	417
CFP350CAMT	416
CFP350CATTN	417
CFP350JBMT	416
CFP350JBTTN	417
CFP350MT	416
CFP350SFMT	416
CFP350SFTTN	417
CFP350TTN	417
CFP400CAMT	416
CFP400CATTN	417
CFP400JBMT	416
CFP400JBTTN	417
CFP400MT	416
CFP400SFMT	416
CFP400SFTTN	417
CFP400TTN	417
CFP5210A5	499
CFP5210BU	499
CFP5275A5	499
CFP5275BU	499
CFP6410A5	499
CFP6410BU	499
CFP6475A5	499
CFP6475BU	499
CFP8410A5	499
CFP8410BU	499
CFP8475A5	499
CFP8475BU	499
CFPS5210	489
CFPS5275	489
CFPS6410	489
CFPS6475	489
CFPS8410	489
CFPS8475	489
CFS52150A5	499
CFS52150BU	499
CFS64150A5	499
CFS64150BU	499
CFS84150A5	499
CFS84150BU	499
CFS52150	489
CFSS64150	489
CFSS84150	489
CGL-250	355
CGL-400	501
CGL-400	355
CGL-400	491
CGL-CLEAR	81
CGU2	355
CGU4	355

Catalog Number	Page
CGU4	491
CGU4	501
CHB1710TTN	353
CHB1775TTN	353
CHB2510TTN	353
CHB2575TTN	353
CHB4010TTN	353
CHB4075TTN	353
CHC1710TTN	352
CHC1775TTN	352
CHC2510TTN	352
CHC2575TTN	352
CHC4010TTN	352
CHC4075TTN	352
CHP1710TTN	352
CHP1775TTN	352
CHP2510TTN	352
CHP2575TTN	352
CHP4010TTN	352
CHP4075TTN	352
CHS17150TTN	353
CHS25150TTN	353
CHS40150TTN	353
CIB30100	617
CIB3075	617
CIC30100	617
CIC3075	617
CIP30100	617
CIP3075	617
CIS30150	617
CJB26FBU	500
CJB32FBU	500
CJB42FBU	500
CJC75-12	698
CJC75-120	698
CJC75-48	698
CJEXRN	369
CJEXRN	501
CJEXRN	512
CJEXRN	618
CJEXRN	624
CJFB2610A5	499
CJFB2610BU	499
CJFB2675A5	499
CJFB2675BU	499
CJFB3210A5	499
CJFB3210BU	499
CJFB3275A5	499
CJFB3275BU	499
CJFB4210A5	499
CJFB4210BU	499
CJFB4275A5	499
CJFB4275BU	499
CJFC2610A5	499
CJFC2610BU	499
CJFC2675A5	499
CJFC2675BU	499
CJFC3210A5	499
CJFC3210BU	499
CJFC3275A5	499
CJFC3275BU	499
CJFC4210A5	499

Alphanumeric Index

Catalog Number	Page	Catalog Number	Page	Catalog Number	Page	Catalog Number	Page
CJFC4210BU	499	CJHC7010TTCN	366	CJLC7010TTCN	366	CLB2510	351
CJFC4275A5	499	CJHC7075MT	366	CJLC7075MT	366	CLB2510TTCN	353
CJFC4275BU	499	CJHC7075TTCN	366	CJLC7075TTCN	366	CLB2575	351
CJFP2610A5	499	CJHP1010MT	366	CJLP1010MT	366	CLB2575TTCN	353
CJFP2610BU	499	CJHP1010TTCN	366	CJLP1010TTCN	366	CLB4010	351
CJFP2675A5	499	CJHP1075MT	366	CJLP1075MT	366	CLB4010TTCN	353
CJFP2675BU	499	CJHP1075TTCN	366	CJLP1075TTCN	366	CLB4075	351
CJFP3210A5	499	CJHP1710MT	366	CJLP1510MT	366	CLB4075TTCN	353
CJFP3210BU	499	CJHP1710TTCN	366	CJLP1510TTCN	366	CLB5010	351
CJFP3275A5	499	CJHP1775MT	366	CJLP1575MT	366	CLB5075	351
CJFP3275BU	499	CJHP1775TTCN	366	CJLP1575TTCN	366	CLB7010	351
CJFP4210A5	499	CJHP5010MT	366	CJLP5010MT	366	CLB7010TTCN	353
CJFP4210BU	499	CJHP5010TTCN	366	CJLP5010TTCN	366	CLB7075	351
CJFP4275A5	499	CJHP5075MT	366	CJLP5075MT	366	CLB7075TTCN	353
CJFP4275BU	499	CJHP5075TTCN	366	CJLP5075TTCN	366	CLC1010	350
CJFPB2675BU	498	CJHP7010MT	366	CJLP7010MT	366	CLC1010TTCN	352
CJFPB3275BU	498	CJHP7010TTCN	366	CJLP7010TTCN	366	CLC1075	350
CJFPB4275BU	498	CJHP7075MT	366	CJLP7075MT	366	CLC1075TTCN	352
CJFS26150A5	499	CJHP7075TTCN	366	CJLP7075TTCN	366	CLC1510	350
CJFS26150BU	499	CJHPB1075	365	CJLPB1075	365	CLC1510TTCN	352
CJFS32150A5	499	CJHPB5075	365	CJLPB1575	365	CLC1575	350
CJFS32150BU	499	CJHPB7075	365	CJLPB5075	365	CLC1575TTCN	352
CJFS42150A5	499	CJHS10150MT	367	CJLPB7075	365	CLC2510	350
CJFS42150BU	499	CJHS10150TTCN	367	CJLS10150MT	367	CLC2510TTCN	352
CJFSB26150BU	498	CJHS17150MT	367	CJLS10150TTCN	367	CLC2575	350
CJFSB32150BU	498	CJHS17150TTCN	367	CJLS15150MT	367	CLC2575TTCN	352
CJFSB42150BU	498	CJHS50150MT	367	CJLS15150TTCN	367	CLC4010	350
CJGL-175	369	CJHS50150TTCN	367	CJLS50150MT	367	CLC4010TTCN	352
CJGL-175	501	CJHS70150MT	367	CJLS50150TTCN	367	CLC4075	350
CJGU-15	369	CJHS70150TTCN	367	CJLS70150MT	367	CLC4075TTCN	352
CJGU-15	501	CJHSB10150	365	CJLS70150TTCN	367	CLC5010	350
CJGU-15	581	CJHSB50150	365	CJLSB10150	365	CLC5075	350
CJGU-15	618	CJHSB70150	365	CJLSB15150	365	CLC7010	350
CJHB1010MT	367	CJLB1010MT	367	CJLSB50150	365	CLC7010TTCN	352
CJHB1010TTCN	367	CJLB1010TTCN	367	CJLSB70150	365	CLC7075	350
CJHB1075MT	367	CJLB1075MT	367	CJMS-175	369	CLC7075TTCN	352
CJHB1075TTCN	367	CJLB1075TTCN	367	CJNC301	618	CLP1010	350
CJHB1710MT	367	CJLB1510MT	367	CJPB1710MT	367	CLP1010TTCN	352
CJHB1710TTCN	367	CJLB1510TTCN	367	CJPB1710TTCN	367	CLP1075	350
CJHB1775MT	367	CJLB1575MT	367	CJPB1775MT	367	CLP1075TTCN	352
CJHB1775TTCN	367	CJLB1575TTCN	367	CJPB1775TTCN	367	CLP1510	350
CJHB5010MT	367	CJLB5010MT	367	CJPC1710MT	366	CLP1510TTCN	352
CJHB5010TTCN	367	CJLB5010TTCN	367	CJPC1710TTCN	366	CLP1575	350
CJHB5075MT	367	CJLB5075MT	367	CJPC1775MT	366	CLP1575TTCN	352
CJHB5075TTCN	367	CJLB5075TTCN	367	CJPC1775TTCN	366	CLP2510	350
CJHB7010MT	367	CJLB7010MT	367	CJPP1710MT	366	CLP2510TTCN	352
CJHB7010TTCN	367	CJLB7010TTCN	367	CJPP1710TTCN	366	CLP2575	350
CJHB7075MT	367	CJLB7075MT	367	CJPP1775MT	366	CLP2575TTCN	352
CJHB7075TTCN	367	CJLB7075TTCN	367	CJPP1775TTCN	366	CLP4010	350
CJHC1010MT	366	CJLC1010MT	366	CJPPB1775	365	CLP4010TTCN	352
CJHC1010TTCN	366	CJLC1010TTCN	366	CJPS17150MT	367	CLP4075	350
CJHC1075MT	366	CJLC1075MT	366	CJPS17150TTCN	367	CLP4075TTCN	352
CJHC1075TTCN	366	CJLC1075TTCN	366	CJPSB17150	365	CLP5010	350
CJHC1710MT	366	CJLC1510MT	366	CJSA42	502	CLP5075	350
CJHC1710TTCN	366	CJLC1510TTCN	366	CLB1010	351	CLP7010	350
CJHC1775MT	366	CJLC1575MT	366	CLB1010TTCN	353	CLP7010TTCN	352
CJHC1775TTCN	366	CJLC1575TTCN	366	CLB1075	351	CLP7075	350
CJHC5010MT	366	CJLC5010MT	366	CLB1075TTCN	353	CLP7075TTCN	352
CJHC5010TTCN	366	CJLC5010TTCN	366	CLB1510	351	CLS10150	351
CJHC5075MT	366	CJLC5075MT	366	CLB1510TTCN	353	CLS10150TTCN	353
CJHC5075TTCN	366	CJLC5075TTCN	366	CLB1575	351	CLS15150	351
CJHC7010MT	366	CJLC7010MT	366	CLB1575TTCN	353	CLS15150TTCN	353

Alphanumeric Index

Catalog Number	Page	Catalog Number	Page	Catalog Number	Page	Catalog Number	Page
CLS25150	351	CMLEDC102G5	77	CMR-4AN	172	CPC3275TTCN	352
CLS25150TTCN	353	CMLEDC103G5	77	CMR-4DD	355	CPC3510	350
CLS40150	351	CMLEDC152G5	77	CMR-4DD	418	CPC3510TTCN	352
CLS40150TTCN	353	CMLEDC153G5	77	CMR-4DD	298	CPC3575	350
CLS50150	351	CMLEDC172G5	77	CMR-4DD	318	CPC3575TTCN	352
CLS70150	351	CMLEDC173G5	77	CMR-4DD	491	CPC4010	350
CLS70150TTCN	353	CMLEDC252G5	77	CMR-4DD	501	CPC4010TTCN	352
CMAD-1	354	CMLEDC253G5	77	CMR-4DD	172	CPC4075	350
CMAD-1	368	CMLEDC352G5	77	CMR-4DD	190	CPC4075TTCN	352
CMAD-1	490	CMLEDC353G5	77	CMR-4DD	210	CPP1710	350
CMAD-1	500	CMLEDC402G5	77	CMR-4DD	238	CPP1710TTCN	352
CMBF52BU	500	CMLEDC403G5	77	CMR-4DD	273	CPP1775	350
CMBF64BU	500	CMLEDC702G5	77	CMR-4HB	355	CPP1775TTCN	352
CMBF84BU	500	CMLEDC703G5	77	CMR-4HB	418	CPP2510	350
CMBFS52	489	CMLEDF-2	81	CMR-4HB	491	CPP2510TTCN	352
CMBFS64	489	CMLEDF-3	81	CMR-4HB	501	CPP2575	350
CMBFS84	489	CMLEDF-5	81	CMR-4ST	233	CPP2575TTCN	352
CMBH175	354	CMLEDGU	81	CMR-4ST	268	CPP3210	350
CMBH250	354	CMLEDS104G5	78	CMR-4ST	355	CPP3210TTCN	352
CMBH400	354	CMLEDS105G5	78	CMR-4ST	418	CPP3275	350
CMBL100	354	CMLEDS154G5	78	CMR-4ST	381	CPP3275TTCN	352
CMBL150	354	CMLEDS155G5	78	CMR-4ST	491	CPP3510	350
CMBL250	354	CMLEDS174G5	78	CMR-4ST	501	CPP3510TTCN	352
CMBL400	354	CMLEDS175G5	78	CMR-4ST	238	CPP3575	350
CMBL50	354	CMLEDS254G5	78	CMR-4ST	273	CPP3575TTCN	352
CMBL70	354	CMLEDS255G5	78	CMR-4ST	298	CPP4010	350
CMBP175	354	CMLEDS354G5	78	CMR-4ST	318	CPP4010TTCN	352
CMBP250	354	CMLEDS355G5	78	CMR-4ST	172	CPP4075	350
CMBP320	354	CMLEDS404G5	78	CMR-4ST	190	CPP4075TTCN	352
CMBP350	354	CMLEDS405G5	78	CMR-4ST	210	CPS17150	351
CMBP400	354	CMLEDS704G5	78	CMS-400	355	CPS17150TTCN	353
CML10A5W	81	CMLEDS705G5	78	CPB1710	351	CPS25150	351
CML10G5	79	CML10G5	81	CPB1710TTCN	353	CPS25150TTCN	353
CML15A5W	81	CML15A5W	81	CPB1775	351	CPS32150	351
CML15G5	79	CML15G5	79	CPB1775TTCN	353	CPS32150TTCN	353
CML17A5W	81	CML17A5W	81	CPB2510	351	CPS35150	351
CML17G5	79	CML17G5	79	CPB2510TTCN	353	CPS35150TTCN	353
CML25A5W	81	CML25A5W	81	CPB2575	351	CPS40150	351
CML25G5	79	CML25G5	79	CPB2575TTCN	353	CPS40150TTCN	353
CML35A5W	81	CML35A5W	81	CPB3210	351	CPSK20-50	685
CML35G5	79	CML35G5	79	CPB3210TTCN	353	CPSK20-50ACN	685
CML40A5W	81	CML40A5W	81	CPB3275	351	CPSK20-50CN	685
CML40G5	79	CML40G5	79	CPB3275TTCN	353	CPSK20-75	685
CML70A5W	81	CML70A5W	81	CPB3510	351	CPSK20-75ACN	685
CML70G5	79	CML70G5	79	CPB3510TTCN	353	CPSK20-75CN	685
CML102G5	77	CML102G5	77	CPB3575	351	CPU20-50	685
CML103G5	77	CML103G5	77	CPB3575TTCN	353	CPU20-50ACN	685
CML152G5	77	CML152G5	77	CPB4010	351	CPU20-50CN	685
CML153G5	77	CML153G5	77	CPB4010TTCN	353	CPU20-75	685
CML172G5	77	CML172G5	77	CPB4075	351	CPU20-75ACN	685
CML173G5	77	CML173G5	77	CPB4075TTCN	353	CPU20-75CN	685
CML252G5	77	CML252G5	77	CPC1710	350	CSA84	502
CML253G5	77	CML253G5	77	CPC1710TTCN	352	CSSB75120ACCL	579
CML252G5	77	CML252G5	77	CPC1775	350	CSSB752030DCCLP	580
CML253G5	77	CML253G5	77	CPC1775TTCN	352	CSSB75240ACCL	579
CML352G5	77	CML352G5	77	CPC2510	350	CSSB7524DCCL	579
CML353G5	77	CML353G5	77	CPC2510TTCN	352	CSSB75250DCCL	579
CML402G5	77	CML402G5	77	CPC2575	350	CSSC75120ACCL	579
CML403G5	77	CML403G5	77	CPC2575TTCN	352	CSSC752030DCCLP	580
CML402G5	77	CML402G5	77	CPC3210	350	CSSC75240ACCL	579
CML403G5	77	CML403G5	77	CPC3210TTCN	352	CSSC7524DCCL	579
CML702G5	77	CML702G5	77	CPC3275	350	CSSC75250DCCL	579
CML703G5	77	CML703G5	77				
CML102G5	77	CML102G5	77				
CML103G5	77	CML103G5	77				
CML152G5	77	CML152G5	77				
CML153G5	77	CML153G5	77				
CML172G5	77	CML172G5	77				
CML173G5	77	CML173G5	77				
CML252G5	77	CML252G5	77				
CML253G5	77	CML253G5	77				
CML352G5	77	CML352G5	77				
CML353G5	77	CML353G5	77				
CML402G5	77	CML402G5	77				
CML403G5	77	CML403G5	77				
CML702G5	77	CML702G5	77				
CML703G5	77	CML703G5	77				
CML102G5	77	CML102G5	77				
CML103G5	77	CML103G5	77				
CML152G5	77	CML152G5	77				
CML153G5	77	CML153G5	77				
CML172G5	77	CML172G5	77				
CML173G5	77	CML173G5	77				
CML252G5	77	CML252G5	77				
CML253G5	77	CML253G5	77				
CML352G5	77	CML352G5	77				
CML353G5	77	CML353G5	77				
CML402G5	77	CML402G5	77				
CML403G5	77	CML403G5	77				
CML702G5	77	CML702G5	77				
CML703G5	77	CML703G5	77				
CMLEDBH	81	CMLEDBH	81				
CMLEDBU	81	CMLEDBU	81				
CMLEDBU40	81	CMLEDBU40	81				

Alphanumeric Index

Catalog Number	Page	Catalog Number	Page	Catalog Number	Page	Catalog Number	Page
CSSP75120ACCL	579	EFLP25B-TTCN	423	FDB258BUM	547	FDHC49Z	158
CSSP752030DCCLP	580	EFLP40B-TTCN	423	FDB258BUME	547	FDHC49Z	548
CSSP75240ACCL	579	EFLQ10B-A1CN	423	FDB258X3M	546	FDHC49Z	567
CSSP7524DCCL	579	EFLQ50B-A1CN	423	FDB258XCM	546	FDHC49Z	593
CSSP75250DCCL	579	EFP248	519	FDB336BUM	547	FDHC49Z	648
CSST120ACCL	579	EHL100N	669	FDB358BUM	547	FDHC60S	89
CSST2030PDCCL	580	ELS012	510	FDBAESLEDEM	157	FDHC60S	91
CSST240ACCL	579	ELS06	510	FDBAESLEDEMA	157	FDHC60S	158
CSST24PDCCL	579	ELS1100712A	639	FDBAESLEDEMAW	157	FDHC60S	548
CSST250DCCL	579	ELS1100712B	639	FDBAESLEDEMW	157	FDHC60S	567
DEMULEDE042	91	ELS11812	510	FDBAESLEDEN	157	FDHC60S	648
DEMULEDE042A	91	ELS1186	510	FDBAESLEDENA	157	FDHC60Z	89
DPGU-2	634	ELS1210712A	639	FDBAESLEDEENW	157	FDHC60Z	91
EDTP2050	634	ELS1210712B	639	FDBAESLEDSL	157	FDHC60Z	158
EFD110ANLQ	677	ELS12812	510	FDBAESLEDSLMA	157	FDHC60Z	548
EFD110NLQ	677	ELS1286	510	FDBAESLEDSLMAW	157	FDHC60Z	567
EFD150ANLQ	677	ELS2100712A	639	FDBAESLEDSLMAW	157	FDHC60Z	593
EFD150NLQ	677	ELS2100712B	639	FDBAESLEDSL	157	FDHC60Z	648
EFD175ANLQ	677	ELS21812	510	FDBAESLEDSLNA	157	FDPG1Z	89
EFD175NLQ	677	ELS2186	510	FDBAESLEDSLNW	157	FDPG1Z	91
EFDC110ANLQ	677	ELS2210712A	639	FDC118XCM	547	FDPG1Z	548
EFDC110NLQ	677	ELS2210712B	639	FDC136XCM	547	FDPG1Z	567
EFDC150ANLQ	677	ELS22812	510	FDC218XCM	547	FDPG1Z	593
EFDC150NLQ	677	ELS2286	510	FDC236XCM	547	FDPG1Z	648
EFDC175ANLQ	677	ESD50	688	FDC-32R1	575	FDPG2Z	89
EFDC175NLQ	677	ESD75	688	FDC-32R2	575	FDPG2Z	548
EFDCB150J1U1-T-A	512	ESS50	688	FDER1G	548	FDPG3Z	548
EFH75-120	685	ESS75	688	FDER1G	567	FDPG4Z	548
EFH75-120CN	685	EXJF110	688	FDER1G	648	FDPG5Z	89
EFH75-48	685	EXJF112	688	FDER2G	548	FDPG5Z	158
EFH75-48CN	685	EXJF115	688	FDER3G	548	FDPG5Z	648
EFHC1050	691	EXJF118	688	FDER4G	548	FDSBS	89
EFHC1075	691	EXJF14	688	FDER5G	158	FDSBS	91
EFHC7550	691	EXJF16	688	FDES1081M	566	FDSBS	158
EFHC7575	691	EXJF18	688	FDES1081N	566	FDSBS	548
EFHCA1050	691	EXJF210	688	FDES1082M	566	FDSBS	567
EFHCA1075	691	EXJF212	688	FDES1082N	566	FDSBS	593
EFHCA7550	691	EXJF215	688	FDES1083N	566	FDSBS	648
EFHCA7575	691	EXJF218	688	FDES1084M	566	FDSBZ	89
EFHF-50	682	EXJF24	688	FDES2084S	566	FDSBZ	91
EFHF-50	704	EXJF26	688	FDLBS	89	FDSBZ	158
EFHF-75	682	EXJF28	688	FDLBS	91	FDSBZ	548
EFHF-75	704	EXR400	501	FDLBS	158	FDSBZ	567
EFHM-50	682	FD-3J1	575	FDLBS	548	FDSBZ	593
EFHM-50	704	FDB118X3M	546	FDLBS	567	FDSBZ	648
EFHM-75	682	FDB118XCM	546	FDLBS	593	FDSCS	89
EFHM-75	704	FDB136X3M	546	FDLBS	648	FDSCS	91
EFHU75-120	685	FDB136XCM	546	FDLBS	89	FDSCS	158
EFHU75-120CN	685	FDB158BUM	547	FDLBS	91	FDSCS	527
EFHU75-48	685	FDB158X3M	546	FDLBS	158	FDSCS	548
EFHU75-48CN	685	FDB158XCM	546	FDLBS	548	FDSCS	567
EFKB-J1U1-TEST	512	FDB218AAM	546	FDLBS	567	FDSCS	648
EFKB-PC120	677	FDB218BUM	547	FDLBS	593	FEB118BUSA	553
EFKB-PC277	677	FDB218BUME	547	FDLBS	648	FEB118BUSN	553
EFLH15B-TTCN	423	FDB218X3M	546	FDHC49S	89	FEB118BUSNL	555
EFLH25B-TTCN	423	FDB218XCM	546	FDHC49S	91	FEB136BUSA	553
EFLH40B-TTCN	423	FDB236AAM	546	FDHC49S	158	FEB136BUSN	553
EFL15B-TTCN	423	FDB236BUM	547	FDHC49S	548	FEB136BUSNL	555
EFL25B-TTCN	423	FDB236BUME	547	FDHC49S	567	FEB158BUSA	553
EFL40B-TTCN	423	FDB236X3M	546	FDHC49S	648	FEB158BUSN	553
EFLP17B-TTCN	423	FDB236XCM	546	FDHC49Z	89	FEB158BUSNL	555
EFLP20B-TTCN	423	FDB258AAM	546	FDHC49Z	91	FEB218BULA	554

Alphanumeric Index

Catalog Number	Page	Catalog Number	Page	Catalog Number	Page	Catalog Number	Page
FEB218BULAE	558	FEHBA	99	FHLM-50	706	FSKA-PC247D2	213
FEB218BULN	554	FEHBA	163	FHLM-75	706	FSKA-PC247D2	242
FEB218BULNE	558	FEHBA	527	FHS1	682	FSKA-PC247D2	277
FEB218BUPN	555	FEHBA	532	FHS5075	704	FSKA-PC247D2	301
FEB218BUPNE	558	FEHBA	559	FHS5075	682	FSKA-PC247D2	321
FEB218BUSAE	553	FEHBS	163	FHSN-100	706	FSKA-PC247D2	678
FEB218BUSAE	556	FEHBS	527	FHSN-50	706	FVSM	52
FEB218BUSN	553	FEHBS	532	FHSN-75	706	FVSM	65
FEB218BUSNE	556	FEHBS	559	FLB118BKSA	526	FVSM	98
FEB218BUTA	554	FEHC49S	65	FLB136BKSA	526	FVWF	53
FEB218BUTAE	557	FEHC49S	163	FLB136BUSA	526	FVWF	66
FEB218BUTN	554	FEHC49S	527	FLB158BKSA	526	FVWF	99
FEB218BUTNE	557	FEHC49S	532	FLB158BUSA	526	G-1PCR	406
FEB236BULA	554	FEHC49S	559	FLB218BKSA	526	G-1PCR	446
FEB236BULAE	558	FEHC49Z	65	FLB218BUSA	526	G-1PCR	450
FEB236BULN	554	FEHC49Z	163	FLB218BUSAE	526	G-7PR	385
FEB236BULNE	558	FEHC49Z	527	FLB236BKSA	526	G-7PR-IL	385
FEB236BUPN	555	FEHC49Z	532	FLB236BUSA	526	G-7PR-ILP	385
FEB236BUPNE	558	FEHC49Z	559	FLB236BUSAE	526	G-AM3271P-48	445
FEB236BUSAE	553	FEHC60S	65	FLB258BKSA	526	G-AM3271P-48-I/2	399
FEB236BUSAE	556	FEHC60S	163	FLB258BUSA	526	G-AM3271P-48-Z2	399
FEB236BUSN	553	FEHC60S	527	FLB258BUSAE	526	G-AM3271P-MT	445
FEB236BUSNE	556	FEHC60S	532	FNB218BKSA	531	G-AM3271P-MT-I/2	399
FEB236BUTA	554	FEHC60S	559	FNB218BKSN	531	G-AM3271P-MT-Z2	399
FEB236BUTAE	557	FEHC60Z	65	FNB218BUSAEN	531	G-AM3271P-TT-I/2	399
FEB236BUTN	554	FEHC60Z	163	FNB218BUSAN	531	G-AM3271P-TT-Z2	399
FEB236BUTNE	557	FEHC60Z	527	FNB218BUSNEN	531	G-AM3275P-48	445
FEB258BULA	554	FEHC60Z	532	FNB218BUSNN	531	G-AM3275P-MT	445
FEB258BULAE	558	FEHC60Z	559	FNB236BKSA	531	G-AM571H-C7-I/2	399
FEB258BULN	554	FERBM8Z	53	FNB236BKSN	531	G-AM571H-C7-Z2	399
FEB258BULNE	558	FERBM8Z	66	FNB236BUSAEN	531	G-AM571H-TT-I/2	399
FEB258BUSAE	553	FERBM8Z	99	FNB236BUSAN	531	G-AM571H-TT-Z2	399
FEB258BUSAE	556	FERBM8Z	163	FNB236BUSNEN	531	G-AM571H-XP-I/2	399
FEB258BUSN	553	FERBM8Z	527	FNB236BUSNN	531	G-AM571H-XP-Z2	399
FEB258BUSNE	556	FERBM8Z	532	FNB258BKSA	531	G-AM571P-48	445
FEB258BUTA	554	FERBM8Z	559	FNB258BKSN	531	G-AM571P-48-I/2	399
FEB258BUTAE	557	FESBA	52	FNB258BUSAEN	531	G-AM571P-48-Z2	399
FEB258BUTN	554	FESBA	64	FNB258BUSAN	531	G-AM571P-MT	445
FEB258BUTNE	557	FESBA	98	FNB258BUSNEN	531	G-AM571P-MT-I/2	399
FEB336BUSA	553	FESBA	163	FNB258BUSNN	531	G-AM571P-MT-Z2	399
FEB336BUSAE	556	FESBA	527	FNESLEDEU	162	G-AM571P-TT-I/2	399
FEB336BUSN	553	FESBA	532	FNESLEDSLU	162	G-AM571P-TT-Z2	399
FEB336BUSNE	556	FESBS	52	FS601	575	G-AM575P-48	445
FEB358BUSA	553	FESBS	64	FS601D2	575	G-AM575P-MT	445
FEB358BUSAE	556	FESBS	98	FSKA-PC120	128	G-AM671H-C7-I/2	399
FEB358BUSN	553	FESBS	163	FSKA-PC120	679	G-AM671H-C7-Z2	399
FEB358BUSNE	556	FESBS	527	FSKA-PC120D2	23	G-AM671H-TT-I/2	399
FEFBS	52	FESBS	532	FSKA-PC120D2	41	G-AM671H-TT-Z2	399
FEFBS	64	FESBS	559	FSKA-PC120D2	175	G-AM671H-XP-I/2	399
FEFBS	98	FESCM20	430	FSKA-PC120D2	193	G-AM671H-XP-Z2	399
FEFBS	163	FESCM20	559	FSKA-PC120D2	213	G-AM671L-48	445
FEFBS	527	FESCM25	559	FSKA-PC120D2	242	G-AM671L-48-I/2	398
FEFBS	532	FEWMG	532	FSKA-PC120D2	277	G-AM671L-48-Z2	398
FEFBZ	64	FEWMG	559	FSKA-PC120D2	301	G-AM671L-C7-I/2	398
FEFBZ	163	FHHCG-3750-SS	706	FSKA-PC120D2	321	G-AM671L-C7-Z2	398
FEFBZ	527	FHHCG-3775-SS	706	FSKA-PC120D2	678	G-AM671L-MT	445
FEFBZ	532	FHHF-50	706	FSKA-PC247	128	G-AM671L-MT-I/2	398
FEFBZ	559	FHHF-75	706	FSKA-PC247	679	G-AM671L-MT-Z2	398
FEHBA	53	FHHM-50	706	FSKA-PC247D2	23	G-AM671L-TT-I/2	398
FEHBA	55	FHHM-75	706	FSKA-PC247D2	41	G-AM671L-TT-Z2	398
FEHBA	65	FHLF-50	706	FSKA-PC247D2	175	G-AM671L-XP-I/2	398
FEHBA	68	FHLF-75	706	FSKA-PC247D2	193	G-AM671L-XP-Z2	398

Alphanumeric Index

Catalog Number	Page	Catalog Number	Page	Catalog Number	Page	Catalog Number	Page
G-AM671P-48	445	G-AM861L-C7-Z	405	G-AML471L-MT-Z2	398	G-HCPL-3-12	707
G-AM671P-48-I/2	399	G-AM861L-MT	449	G-AML471L-TT-I/2	398	G-HCPL-3-24	707
G-AM671P-48-Z2	399	G-AM861L-MT-I/2	405	G-AML471L-TT-Z2	398	G-HCPL-3-27	707
G-AM671P-MT	445	G-AM861L-MT-Z	405	G-AML471L-XP-I/2	398	G-HCPL-3-34	707
G-AM671P-MT-I/2	399	G-AM861L-TT-I/2	405	G-AML471L-XP-Z2	398	G-HCPL-3-48	707
G-AM671P-MT-Z2	399	G-AM861L-TT-Z	405	GAMS671L-48-I2	409	G-HCPL-3-60	707
G-AM671P-TT-I/2	399	G-AM861P-48	449	GAMS671L-C7-I2	409	G-HCPL-4-12	707
G-AM671P-TT-Z2	399	G-AM861P-48-I/2	405	GAMS671L-MT-I2	409	G-HCPL-4-24	707
G-AM675L-48	445	G-AM861P-MT	449	GAMS671L-TT-I2	409	G-HCPL-4-27	707
G-AM675L-MT	445	G-AM861P-MT-I/2	405	GAMS671P-48-I2	409	G-HCPL-4-34	707
G-AM675P-48	445	G-AM865H-48	449	GAMS671P-MT-I2	409	G-HCPL-4-48	707
G-AM675P-MT	445	G-AM865H-MT	449	GAMS671P-TT-I2	409	G-HCPL-4-60	707
G-AM-6-NV	406	G-AM865L-48	449	GAMS771L-48-I2	409	GHPHP12	707
G-AM-6-NV	450	G-AM865L-MT	449	GAMS771L-C7-I2	409	GHPHP24	707
G-AM-6-V	400	G-AM865P-48	449	GAMS771L-MT-I2	409	GHPHP27	707
G-AM-6-V	446	G-AM865P-MT	449	GAMS771L-TT-I2	409	GHPHP34	707
G-AM-6-VS	400	G-AM-8-CA	140	GAMS771P-48-I2	409	GHPHP48	707
G-AM-6-VS	446	G-AM-8-CA	147	GAMS771P-MT-I2	409	GHPHP60	707
G-AM771H-C7-I/2	399	G-AM-8-CA	153	GAMS771P-TT-I2	409	GHPHT12	707
G-AM771H-C7-Z2	399	G-AM-8-CA	400	G-EFJB-30	667	GHPHT24	707
G-AM771H-TT-I/2	399	G-AM-8-CA	406	G-EFWB-30	667	GHPHT27	707
G-AM771H-TT-Z2	399	G-AM-8-CA	409	G-F10	454	GHPHT34	707
G-AM771H-XP-I/2	399	G-AM-8-CA	418	G-F10	707	GHPHT48	707
G-AM771H-XP-Z2	399	G-AM-8-CA	446	G-F20	454	GHPHT60	707
G-AM771L-48	445	G-AM-8-CA	450	G-F20	707	GMP400BUPS	717
G-AM771L-48-I/2	398	G-AM-8-CA	454	G-F30	707	G-PB-14	714
G-AM771L-48-Z2	398	G-AM-8-NVS	406	G-F6	707	G-PB-2	714
G-AM771L-C7-I/2	398	G-AM-8-NVS	450	G-HB20-G	389	G-PB-3	714
G-AM771L-C7-Z2	398	G-AM-8-SF	140	G-HB411L-48	385	G-PB-3-120	714
G-AM771L-MT	445	G-AM-8-SF	147	G-HB411L-MT	385	G-PB-4	714
G-AM771L-MT-I/2	398	G-AM-8-SF	153	G-HB411L-TT	385	G-PCAB-4	716
G-AM771L-MT-Z2	398	G-AM-8-SF	430	G-HB41PL-48	385	G-PCB-1	716
G-AM771L-TT-I/2	398	G-AM-8-SF	400	G-HB41PL-MT	385	G-PCB-2	716
G-AM771L-TT-Z2	398	G-AM-8-SF	406	G-HB41PL-TT	385	G-PCB-3	716
G-AM771L-XP-I/2	398	G-AM-8-SF	409	G-HB611L-48	385	G-PCB-4	716
G-AM771L-XP-Z2	398	G-AM-8-SF	446	G-HB611L-MT	385	G-PHSH-20	710
G-AM771P-48	445	G-AM-8-SF	450	G-HB611L-TT	385	G-PHSH-24	710
G-AM771P-48-I/2	399	G-AM-8-SF	454	G-HB61PL-48	385	G-PHSH-30	710
G-AM771P-48-Z2	399	G-AM-8-WB	140	G-HB61PL-MT	385	G-PHSH-35	710
G-AM771P-MT	445	G-AM-8-WB	147	G-HB61PL-TT	385	G-PHSM-20	710
G-AM771P-MT-I/2	399	G-AM-8-WB	153	G-HB7000-NG	298	G-PHSM-24	710
G-AM771P-MT-Z2	399	G-AM-8-WB	400	G-HB7000-NG	318	G-PHSM-30	710
G-AM771P-TT-I/2	399	G-AM-8-WB	406	G-HB-7000-SC	389	G-PQM-12T	715
G-AM771P-TT-Z2	399	G-AM-8-WB	409	G-HB711L-48	385	G-PQM-12W	715
G-AM775L-48	445	G-AM-8-WB	446	G-HB711L-MT	385	G-PQM-4T	715
G-AM775L-MT	445	G-AM-8-WB	450	G-HB711L-TT	385	G-PQM-4W	715
G-AM775P-48	445	G-AM-8-WB	454	G-HB71PL-48	385	G-PQM-8T	715
G-AM775P-MT	445	G-AM961H-48	449	G-HB71PL-MT	385	G-PQM-8W	715
G-AM861H-48	449	G-AM961H-MT	449	G-HB71PL-TT	385	G-PR-2-1/2	715
G-AM861H-48-I/2	405	G-AM965H-48	449	G-HBPH-120	708	G-PR-3	715
G-AM861H-48-Z	405	G-AM965H-MT	449	G-HBPH-208	708	G-PR-3-1/2	715
G-AM861H-C7-I/2	405	G-AML371L-48-I/2	398	G-HBPH-240	708	G-PR-4	715
G-AM861H-C7-Z	405	G-AML371L-48-Z2	398	G-HBPH-277	708	G-PR-5	715
G-AM861H-MT	449	G-AML371L-MT-I/2	398	G-HBPH-347	708	G-PRTH-20	709
G-AM861H-MT-I/2	405	G-AML371L-MT-Z2	398	G-HBPH-480	708	G-PRTH-25	709
G-AM861H-MT-Z	405	G-AML371L-XP-I/2	398	G-HBPH-600	708	G-PRTH-30	709
G-AM861H-TT-I/2	405	G-AML371L-XP-Z2	398	G-HCPL-2-12	707	G-PRTH-35	709
G-AM861H-TT-Z	405	G-AML471L-48-I/2	398	G-HCPL-2-24	707	G-PRTH-39	709
G-AM861L-48	449	G-AML471L-48-Z2	398	G-HCPL-2-27	707	G-PSSH-14	712
G-AM861L-48-I/2	405	G-AML471L-C7-I/2	398	G-HCPL-2-34	707	G-PSSH-17	712
G-AM861L-48-Z	405	G-AML471L-C7-Z2	398	G-HCPL-2-48	707	G-PSSH-20	712
G-AM861L-C7-I/2	405	G-AML471L-MT-I/2	398	G-HCPL-2-60	707	G-PSSH-24	712

Alphanumeric Index

Catalog Number	Page
G-PSSH-30	712
G-PSSM-14	712
G-PSSM-17	712
G-PSSM-20	712
G-PSSM-24	712
G-PSSM-30	712
G-PSTH-20	711
G-PSTH-24	711
G-PSTH-30	711
G-PSTH-35	711
G-PSTH-39	711
G-PWB-1	716
GRFC-100LC	693
GRFC-100CCN	693
GRFC-50LC	693
GRFC-50LCCN	693
GRFC-75LC	693
GRFC-75LCCN	693
GRFL-100LC	693
GRFL-100LCCN	693
GRFL-50LC	693
GRFL-50LCCN	693
GRFL-75LC	693
GRFL-75LCCN	693
GRFT-100LC	693
GRFT-100LCCN	693
GRFT-50LC	693
GRFT-50LCCN	693
GRFT-75LC	693
GRFT-75LCCN	693
GRFX-100LC	693
GRFX-100LCCN	693
GRFX-50ALCCN	693
GRFX-50LC	693
GRFX-50LCCN	693
GRFX-75ALCCN	693
GRFX-75LC	693
GRFX-75LCCN	693
GRK-100C	693
GRK-100CCN	693
GRK-50	693
GRK-50C	693
GRK-50CCN	693
GRK-50CN	693
GRK-75	693
GRK-75C	693
GRK-75CCN	693
GRK-75CN	693
GRK-75U	693
GRK-75UCN	693
GS2	345
GS2	608
G-SF20	140
G-SF20	147
G-SF20	153
G-SF20	430
G-SF20	400
G-SF20	406
G-SF20	409
G-SF20	446
G-SF20	450
GSK-50-20B	700

Catalog Number	Page
GSK-50-20C	700
GSK-75-20B	700
GSK-75-20C	700
G-SM721L-48N	453
G-SM721LH-48N	453
G-SM721LH-MTN	453
G-SM721L-MTN	453
G-SM731L-48N	453
G-SM731LH-48N	453
G-SM731LH-MTN	453
G-SM731L-MTN	453
G-SM741L-48N	453
G-SM741LH-48N	453
G-SM741LH-MTN	453
G-SM741L-MTN	453
G-SM751L-48N	453
G-SM751LH-48N	453
G-SM751LH-MTN	453
G-SM751L-MTN	453
G-SM761L-48N	453
G-SM761LH-48N	453
G-SM761LH-MTN	453
G-SM761L-MTN	453
G-SM821H-48N	453
G-SM821HH-48N	453
G-SM821HH-MTN	453
G-SM821H-MTN	453
G-SM831H-48N	453
G-SM831HH-48N	453
G-SM831HH-MTN	453
G-SM831H-MTN	453
G-SM841H-48N	453
G-SM841HH-48N	453
G-SM841HH-MTN	453
G-SM841H-MTN	453
G-SM851H-48N	453
G-SM851HH-48N	453
G-SM851HH-MTN	453
G-SM851H-MTN	453
G-SM851L-48N	453
G-SM851LH-48N	453
G-SM851LH-MTN	453
G-SM851L-MTN	453
G-SM861H-48N	453
G-SM861HH-48N	453
G-SM861HH-MTN	453
G-SM861H-MTN	453
G-SM861LH-48N	453
G-SM861LH-MTN	453
G-SM861L-MTN	453
G-SM921H-48N	453
G-SM921HH-48N	453
G-SM921HH-MTN	453
G-SM921H-MTN	453
G-SM931H-48N	453
G-SM931HH-48N	453
G-SM931HH-MTN	453
G-SM931H-MTN	453
G-SM941H-48N	453
G-SM941HH-48N	453
G-SM941HH-MTN	453

Catalog Number	Page
G-SM941H-MTN	453
G-SM951H-48N	453
G-SM951HH-48N	453
G-SM951HH-MTN	453
G-SM951H-MTN	453
G-SM961H-48N	453
G-SM961HH-48N	453
G-SM961HH-MTN	453
G-SM961H-MTN	453
GSU-100	345
GSU-20	345
GSW2	345
GSW2	608
G-WM130L-12R	392
G-WM130L-12RH	392
G-WM134L-12R	392
G-WM134L-12RH	392
G-WM230H-MT	392
G-WM230L-12R	392
G-WM230L-12RH	392
G-WM230L-48	392
G-WM230L-MT	392
G-WM234H-MT	392
G-WM234L-12R	392
G-WM234L-12RH	392
G-WM234L-48	392
G-WM234L-MT	392
G-WM330H-MT	392
G-WM330L-12R	392
G-WM330L-12RH	392
G-WM330L-48	392
G-WM330L-MT	392
G-WM334H-MT	392
G-WM334L-12R	392
G-WM334L-12RH	392
G-WM334L-48	392
G-WM334L-MT	392
G-WM430L-12R	392
G-WM430L-12RH	392
G-WM430L-MT	392
G-WM434L-12R	392
G-WM434L-12RH	392
G-WM434L-MT	392
G-WM-HMK	413
G-WM-L	413
G-WM-LS	413
G-WMM10H-MT	392
G-WMM10L-H1	392
G-WMM10L-MT	392
G-WMM10L-R1	392
G-WMM15L-H1	392
G-WMM15L-R1	392
G-WMM50L-H1	392
G-WMM50L-R1	392
G-WMM70H-MT	392
G-WMM70L-H1	392
G-WMM70L-MT	392
G-WMM70L-R1	392
G-WMWG	413
HBD AF118	662
HBD AI240	662
HBDO	643

Catalog Number	Page
HBDO PGZ	584
HBDO PGZ	643
HBDR	642
HBDR PGZ	642
HBEGD	636
HBEGD	645
HBEPGZ	636
HBEPGZ	645
HBRI15	636
HBRI15	645
HLD501B	673
HLD7002B	673
HLD7502B	673
HRDB100I	664
HRDC020ZE	664
HRDC050ZE	664
IAMLED67AW	147
IAMLED67YBH	146
IAMLED67YBU1	146
IAMLED77AW	147
IAMLED77DBH	147
IAMLED77DBU	147
IAMLED77YBC	146
IAMLED77YBH	146
IAMLED77YBU1	146
IAMLED87AW	147
IAMLED87YBU1	146
IAMLED87YBU1L	147
IAMLEDDBU1R	147
IAMLEDMDOOR	147
IAMLEDMDOORP	147
IMLLED2A5W	124
IMLLED2D5BU	123
IMLLED2G5BU	123
IMLLED2J5BU	123
IMLLED2P5BU	123
IMLLED3A5W	124
IMLLED3D5BU	123
IMLLED3G5BU	123
IMLLED3J5BU	123
IMLLED3P5BU	123
IMLLED4A5W	124
IMLLED4D5BU	123
IMLLED4G5BU	123
IMLLED4J5BU	123
IMLLED4P5BU	123
IMLLEDA22D5	121
IMLLEDA22G5	121
IMLLEDA22J5	121
IMLLEDA22P5	121
IMLLEDA23D5	121
IMLLEDA23G5	121
IMLLEDA23J5	121
IMLLEDA23P5	121
IMLLEDA32D5	121
IMLLEDA32G5	121
IMLLEDA32J5	121
IMLLEDA32P5	121
IMLLEDA33D5	121
IMLLEDA33G5	121
IMLLEDA33J5	121
IMLLEDA33P5	121

Alphanumeric Index

Catalog Number	Page	Catalog Number	Page	Catalog Number	Page	Catalog Number	Page
IMLLEDA42D5	121	IMLLEDR25D5	122	IMLLEDW42J5	122	KPAF-75	188
IMLLEDA42G5	121	IMLLEDR25G5	122	IMLLEDW42P5	122	KPAF-75	208
IMLLEDA42J5	121	IMLLEDR25J5	122	IMLLEDW43D5	122	KPAF-75	233
IMLLEDA42P5	121	IMLLEDR25P5	122	IMLLEDW43G5	122	KPAF-75	234
IMLLEDA43D5	121	IMLLEDR34D5	122	IMLLEDW43J5	122	KPAF-75	268
IMLLEDA43G5	121	IMLLEDR34G5	122	IMLLEDW43P5	122	KPAF-75	269
IMLLEDA43J5	121	IMLLEDR34J5	122	JB1	345	KPAF-75	297
IMLLEDA43P5	121	IMLLEDR34P5	122	JB1	608	KPAF-75	317
IMLLEDC22D5	121	IMLLEDR35D5	122	JB10G-M	606	KPAH1010	231
IMLLEDC22G5	121	IMLLEDR35G5	122	JB1-A	345	KPAH1010	264
IMLLEDC22J5	121	IMLLEDR35J5	122	JB20G-M	606	KPAH1010J5	231
IMLLEDC22P5	121	IMLLEDR35P5	122	JBK-50-BS	700	KPAH1010J5	264
IMLLEDC23D5	121	IMLLEDR44D5	122	JBK-50-CS	700	KPAH1075	231
IMLLEDC23G5	121	IMLLEDR44G5	122	JBK-75-BS	700	KPAH1075	264
IMLLEDC23J5	121	IMLLEDR44J5	122	JBK-75-CS	700	KPAH1075J5	231
IMLLEDC23P5	121	IMLLEDR44P5	122	JBW1	345	KPAH1075J5	264
IMLLEDC32D5	121	IMLLEDR45D5	122	JBW1	608	KPAH1710	266
IMLLEDC32G5	121	IMLLEDR45G5	122	JBW10G-M	606	KPAH1710J5	266
IMLLEDC32J5	121	IMLLEDR45J5	122	JBW1-A	345	KPAH1775	266
IMLLEDC32P5	121	IMLLEDR45P5	122	JBW20G-M	606	KPAH1775J5	266
IMLLEDC33D5	121	IMLLEDS24D5	122	JBX50L-A	345	KPAH2510	266
IMLLEDC33G5	121	IMLLEDS24G5	122	JBX75L-A	345	KPAH2510J5	266
IMLLEDC33J5	121	IMLLEDS24J5	122	JRS-100	346	KPAH2575	266
IMLLEDC33P5	121	IMLLEDS24P5	122	KGU1	190	KPAH2575J5	266
IMLLEDC42D5	121	IMLLEDS25D5	122	KGU1	210	KPAH4010	315
IMLLEDC42G5	121	IMLLEDS25G5	122	KGU2	238	KPAH4010J5	315
IMLLEDC42J5	121	IMLLEDS25J5	122	KGU2	273	KPAH4010R	315
IMLLEDC42P5	121	IMLLEDS25P5	122	KGU2	333	KPAH4075	315
IMLLEDC43D5	121	IMLLEDS34D5	122	KPA-100	20	KPAH4075J5	315
IMLLEDC43G5	121	IMLLEDS34G5	122	KPA-100	36	KPAH4075R	315
IMLLEDC43J5	121	IMLLEDS34J5	122	KPA-100	123	KPAH7010	231
IMLLEDC43P5	121	IMLLEDS34P5	122	KPA-100	171	KPAH7010	264
IMLLEDD22D5	121	IMLLEDS35D5	122	KPA-100	188	KPAH7010J5	231
IMLLEDD22G5	121	IMLLEDS35G5	122	KPA-100	208	KPAH7010J5	264
IMLLEDD22J5	121	IMLLEDS35J5	122	KPA-100	233	KPAH7075	231
IMLLEDD22P5	121	IMLLEDS35P5	122	KPA-100	234	KPAH7075	264
IMLLEDD23D5	121	IMLLEDS44D5	122	KPA-100	268	KPAH7075J5	231
IMLLEDD23G5	121	IMLLEDS44G5	122	KPA-100	269	KPAH7075J5	264
IMLLEDD23J5	121	IMLLEDS44J5	122	KPA-100	297	KPAL1010	229
IMLLEDD23P5	121	IMLLEDS44P5	122	KPA-100	317	KPAL1010	262
IMLLEDD32D5	121	IMLLEDS45D5	122	KPA-75	20	KPAL1010J5	229
IMLLEDD32G5	121	IMLLEDS45G5	122	KPA-75	36	KPAL1010J5	262
IMLLEDD32J5	121	IMLLEDS45J5	122	KPA-75	123	KPAL1075	229
IMLLEDD32P5	121	IMLLEDS45P5	122	KPA-75	171	KPAL1075	262
IMLLEDD33D5	121	IMLLEDW22D5	122	KPA-75	188	KPAL1075J5	229
IMLLEDD33G5	121	IMLLEDW22G5	122	KPA-75	208	KPAL1075J5	262
IMLLEDD33J5	121	IMLLEDW22J5	122	KPA-75	233	KPAL1510	229
IMLLEDD33P5	121	IMLLEDW22P5	122	KPA-75	234	KPAL1510	262
IMLLEDD42D5	121	IMLLEDW23D5	122	KPA-75	268	KPAL1510J5	229
IMLLEDD42G5	121	IMLLEDW23G5	122	KPA-75	269	KPAL1510J5	262
IMLLEDD42J5	121	IMLLEDW23J5	122	KPA-75	297	KPAL1575	229
IMLLEDD42P5	121	IMLLEDW23P5	122	KPA-75	317	KPAL1575	262
IMLLEDD43D5	121	IMLLEDW32D5	122	KPAF-100	171	KPAL1575J5	229
IMLLEDD43G5	121	IMLLEDW32G5	122	KPAF-100	188	KPAL1575J5	262
IMLLEDD43J5	121	IMLLEDW32J5	122	KPAF-100	208	KPAL2510	293
IMLLEDD43P5	121	IMLLEDW32P5	122	KPAF-100	233	KPAL2510	311
IMLLEDDBU	124	IMLLEDW33D5	122	KPAF-100	234	KPAL2510J5	293
IMLLEDDBU4	124	IMLLEDW33G5	122	KPAF-100	268	KPAL2510J5	311
IMLLEDR24D5	122	IMLLEDW33J5	122	KPAF-100	269	KPAL2510R	293
IMLLEDR24G5	122	IMLLEDW33P5	122	KPAF-100	297	KPAL2510R	311
IMLLEDR24J5	122	IMLLEDW42D5	122	KPAF-100	317	KPAL2575	293
IMLLEDR24P5	122	IMLLEDW42G5	122	KPAF-75	171	KPAL2575	311

Alphanumeric Index

Catalog Number	Page	Catalog Number	Page	Catalog Number	Page	Catalog Number	Page
KPAL2575J5	293	KPAP2510J5	264	KPB200P	235	KPBU150LJ5G-MT	233
KPAL2575J5	311	KPAP2510J5	295	KPB200P	270	KPBU150LJ5-MT	233
KPAL2575R	293	KPAP2510J5	313	KPB250H	270	KPBU150L-MT	233
KPAL2575R	311	KPAP2510R	295	KPB250L	297	KPBU15L-G2G-TT-L	268
KPAL4010	293	KPAP2510R	313	KPB250L	317	KPBU15L-G2N-TT-L	268
KPAL4010	311	KPAP2575	231	KPB250P	297	KPBU15L-J5G-TT-L	268
KPAL4010J5	293	KPAP2575	264	KPB250P	317	KPBU15L-J5N-TT-L	268
KPAL4010J5	311	KPAP2575	295	KPB320P	297	KPBU175PG-MT	233
KPAL4010R	293	KPAP2575	313	KPB320P	317	KPBU175PJ5-MT	233
KPAL4010R	311	KPAP2575J5	231	KPB350P	297	KPBU175PJ5-MT	233
KPAL4075	293	KPAP2575J5	264	KPB350P	317	KPBU175P-MT	233
KPAL4075	311	KPAP2575J5	295	KPB400H	317	KPBU17H-G2G-TT-L	268
KPAL4075J5	293	KPAP2575J5	313	KPB400L	297	KPBU17H-G2N-TT-L	268
KPAL4075J5	311	KPAP2575R	295	KPB400L	317	KPBU17H-J5G-TT-L	268
KPAL4075R	293	KPAP2575R	313	KPB400P	297	KPBU17H-J5N-TT-L	268
KPAL4075R	311	KPAP3210	295	KPB400P	317	KPBU17P-G2G-TT-L	268
KPAL5010	229	KPAP3210	313	KPB50L	235	KPBU17P-G2N-TT-L	268
KPAL5010	262	KPAP3210J5	295	KPB50L	270	KPBU17P-J5G-TT-L	268
KPAL5010J5	229	KPAP3210J5	313	KPB70H	235	KPBU17P-J5N-TT-L	268
KPAL5010J5	262	KPAP3210R	295	KPB70H	270	KPBU20P-G2G-TT-L	268
KPAL5075	229	KPAP3210R	313	KPB70L	235	KPBU20P-G2N-TT-L	268
KPAL5075	262	KPAP3275	295	KPB70L	270	KPBU20P-J5G-TT-L	268
KPAL5075J5	229	KPAP3275	313	KPBG12	298	KPBU20P-J5N-TT-L	268
KPAL5075J5	262	KPAP3275J5	295	KPBG12	318	KPBU25H-G2G-TT-L	268
KPAL7010	229	KPAP3275J5	313	KPBG250P	235	KPBU25H-G2N-TT-L	268
KPAL7010	262	KPAP3275R	295	KPBG250P	270	KPBU25H-J5G-TT-L	268
KPAL7010J5	229	KPAP3275R	313	KPBR100H	235	KPBU25H-J5N-TT-L	268
KPAL7010J5	262	KPAP3510	295	KPBR100H	270	KPBU70L-G2G-TT-L	268
KPAL7075	229	KPAP3510	313	KPBR100L	235	KPBU70L-G2N-TT-L	268
KPAL7075	262	KPAP3510J5	295	KPBR100L	270	KPBU70LG-MT	233
KPAL7075J5	229	KPAP3510J5	313	KPBR150L	235	KPBU70LJ5G-MT	233
KPAL7075J5	262	KPAP3510R	295	KPBR150L	270	KPBU70L-J5G-TT-L	268
KPA-M20	20	KPAP3510R	313	KPBR150P	235	KPBU70LJ5-MT	233
KPAP1510	231	KPAP3575	295	KPBR150P	270	KPBU70L-J5N-TT-L	268
KPAP1510	264	KPAP3575	313	KPBR175H	270	KPBU70L-MT	233
KPAP1510J5	231	KPAP3575J5	295	KPBR175P	235	KPBUG3100L-MT	233
KPAP1510J5	264	KPAP3575J5	313	KPBR175P	270	KPC-100	20
KPAP1575	231	KPAP3575R	295	KPBR200P	235	KPC-100	36
KPAP1575	264	KPAP3575R	313	KPBR200P	270	KPC-100	123
KPAP1575J5	231	KPAP4010	295	KPBR250H	270	KPC-100	171
KPAP1575J5	264	KPAP4010	313	KPBR250P	235	KPC-100	188
KPAP1710	231	KPAP4010J5	295	KPBR250P	270	KPC-100	208
KPAP1710	264	KPAP4010J5	313	KPBR50L	235	KPC-100	233
KPAP1710J5	231	KPAP4010R	295	KPBR50L	270	KPC-100	234
KPAP1710J5	264	KPAP4010R	313	KPBR70H	235	KPC-100	268
KPAP1775	231	KPAP4075	295	KPBR70H	270	KPC-100	269
KPAP1775	264	KPAP4075	313	KPBR70L	235	KPC-100	297
KPAP1775J5	231	KPAP4075J5	295	KPBR70L	270	KPC-100	317
KPAP1775J5	264	KPAP4075J5	313	KPBU100HG-MT	233	KPC-75	20
KPAP2010	231	KPAP4075R	295	KPBU100HJ5G-MT	233	KPC-75	36
KPAP2010	264	KPAP4075R	313	KPBU100HJ5-MT	233	KPC-75	123
KPAP2010J5	231	KPB100H	235	KPBU100H-MT	233	KPC-75	171
KPAP2010J5	264	KPB100H	270	KPBU100LG-MT	233	KPC-75	188
KPAP2075	231	KPB100L	235	KPBU100LJ5G-MT	233	KPC-75	208
KPAP2075	264	KPB100L	270	KPBU100LJ5-MT	233	KPC-75	233
KPAP2075J5	231	KPB150L	235	KPBU100L-MT	233	KPC-75	234
KPAP2075J5	264	KPB150L	270	KPBU10L-G2G-TT-L	268	KPC-75	268
KPAP2510	231	KPB150P	235	KPBU10L-G2N-TT-L	268	KPC-75	269
KPAP2510	264	KPB150P	270	KPBU10L-G3N-TT-L	268	KPC-75	297
KPAP2510	295	KPB175H	270	KPBU10L-J5G-TT-L	268	KPC-75	317
KPAP2510	313	KPB175P	235	KPBU10L-J5N-TT-L	268	KPCH-100	20
KPAP2510J5	231	KPB175P	270	KPBU150LG-MT	233	KPCH-100	36

Alphanumeric Index

Catalog Number	Page	Catalog Number	Page	Catalog Number	Page	Catalog Number	Page
KPCH-100	123	KPCHL1510	229	KPCHP4075	295	KPCP1510J5	231
KPCH-100	171	KPCHL1510J5	229	KPCHP4075J5	295	KPCP1510J5	264
KPCH-100	188	KPCHL1575	229	KPCHP4075R	295	KPCP1575	231
KPCH-100	208	KPCHL1575J5	229	KPCL1010	229	KPCP1575	264
KPCH-100	233	KPCHL2510	293	KPCL1010	262	KPCP1575J5	231
KPCH-100	234	KPCHL2510J5	293	KPCL1010J5	229	KPCP1575J5	264
KPCH-100	268	KPCHL2510R	293	KPCL1010J5	262	KPCP1710	231
KPCH-100	269	KPCHL2575	293	KPCL1075	229	KPCP1710	264
KPCH-100	297	KPCHL2575J5	293	KPCL1075	262	KPCP1710J5	231
KPCH-100	317	KPCHL2575R	293	KPCL1075J5	229	KPCP1710J5	264
KPCH1010	231	KPCHL4010	293	KPCL1075J5	262	KPCP1775	231
KPCH1010	264	KPCHL4010J5	293	KPCL1510	229	KPCP1775	264
KPCH1010J5	231	KPCHL4010R	293	KPCL1510	262	KPCP1775J5	231
KPCH1010J5	264	KPCHL4075	293	KPCL1510J5	229	KPCP1775J5	264
KPCH1075	231	KPCHL4075J5	293	KPCL1510J5	262	KPCP2010	231
KPCH1075	264	KPCHL4075R	293	KPCL1575	229	KPCP2010	264
KPCH1075J5	231	KPCHL5010	229	KPCL1575	262	KPCP2010J5	231
KPCH1075J5	264	KPCHL5010J5	229	KPCL1575J5	229	KPCP2010J5	264
KPCH1710	266	KPCHL5075	229	KPCL1575J5	262	KPCP2075	231
KPCH1710J5	266	KPCHL5075J5	229	KPCL2510	293	KPCP2075	264
KPCH1775	266	KPCHL7010	229	KPCL2510	311	KPCP2075J5	231
KPCH1775J5	266	KPCHL7010J5	229	KPCL2510J5	293	KPCP2075J5	264
KPCH2510	266	KPCHL7075	229	KPCL2510J5	311	KPCP2510	231
KPCH2510J5	266	KPCHL7075J5	229	KPCL2510R	293	KPCP2510	264
KPCH2575	266	KPCH-M20	20	KPCL2510R	311	KPCP2510	295
KPCH2575J5	266	KPCHP1510	231	KPCL2575	293	KPCP2510	313
KPCH4010	315	KPCHP1510J5	231	KPCL2575	311	KPCP2510J5	231
KPCH4010J5	315	KPCHP1575	231	KPCL2575J5	293	KPCP2510J5	264
KPCH4010R	315	KPCHP1575J5	231	KPCL2575J5	311	KPCP2510J5	295
KPCH4075	315	KPCHP1710	231	KPCL2575R	293	KPCP2510J5	313
KPCH4075J5	315	KPCHP1710J5	231	KPCL2575R	311	KPCP2510R	295
KPCH4075R	315	KPCHP1775	231	KPCL4010	293	KPCP2510R	313
KPCH7010J5	231	KPCHP1775J5	231	KPCL4010	311	KPCP2575	231
KPCH7010J5	264	KPCHP2010	231	KPCL4010J5	293	KPCP2575	264
KPCH7075	231	KPCHP2010J5	231	KPCL4010J5	311	KPCP2575	295
KPCH7075	264	KPCHP2075	231	KPCL4010R	293	KPCP2575	313
KPCH7075J5	231	KPCHP2075J5	231	KPCL4010R	311	KPCP2575J5	231
KPCH7075J5	264	KPCHP2510	231	KPCL4075	293	KPCP2575J5	264
KPCH-75	171	KPCHP2510	295	KPCL4075	311	KPCP2575J5	295
KPCH-75	20	KPCHP2510J5	231	KPCL4075J5	293	KPCP2575J5	313
KPCH-75	36	KPCHP2510J5	295	KPCL4075J5	311	KPCP2575R	295
KPCH-75	123	KPCHP2510R	295	KPCL4075R	293	KPCP2575R	313
KPCH-75	188	KPCHP2575	231	KPCL4075R	311	KPCP3210	295
KPCH-75	208	KPCHP2575	295	KPCL5010	229	KPCP3210	313
KPCH-75	233	KPCHP2575J5	231	KPCL5010	262	KPCP3210J5	295
KPCH-75	234	KPCHP2575J5	295	KPCL5010J5	229	KPCP3210J5	313
KPCH-75	268	KPCHP2575R	295	KPCL5010J5	262	KPCP3210R	295
KPCH-75	269	KPCHP3210	295	KPCL5075	229	KPCP3210R	313
KPCH-75	297	KPCHP3210J5	295	KPCL5075	262	KPCP3275	295
KPCH-75	317	KPCHP3210R	295	KPCL5075J5	229	KPCP3275	313
KPCHH1010	231	KPCHP3275	295	KPCL5075J5	262	KPCP3275J5	295
KPCHH1010J5	231	KPCHP3275J5	295	KPCL7010	229	KPCP3275J5	313
KPCHH1075	231	KPCHP3275R	295	KPCL7010	262	KPCP3275R	295
KPCHH1075J5	231	KPCHP3510	295	KPCL7010J5	229	KPCP3275R	313
KPCHH7010	231	KPCHP3510J5	295	KPCL7010J5	262	KPCP3510	295
KPCHH7010J5	231	KPCHP3510R	295	KPCL7075	229	KPCP3510	313
KPCHH7075	231	KPCHP3575	295	KPCL7075	262	KPCP3510J5	295
KPCHH7075J5	231	KPCHP3575J5	295	KPCL7075J5	229	KPCP3510J5	313
KPCHL1010	229	KPCHP3575R	295	KPCL7075J5	262	KPCP3510R	295
KPCHL1010J5	229	KPCHP4010	295	KPC-M20	20	KPCP3510R	313
KPCHL1075	229	KPCHP4010J5	295	KPCP1510	231	KPCP3575	295
KPCHL1075J5	229	KPCHP4010R	295	KPCP1510	264	KPCP3575	313

Alphanumeric Index

Catalog Number	Page	Catalog Number	Page	Catalog Number	Page	Catalog Number	Page
KPCP3575J5	295	KPDL7010	262	KPRH25125	267	KPRP25150J5	314
KPCP3575J5	313	KPDL7010J5	262	KPRH25125J5	267	KPRP25150R	314
KPCP3575R	295	KPDL7075	262	KPRH25150	267	KPRP32125	314
KPCP3575R	313	KPDL7075J5	262	KPRH25150J5	267	KPRP32125J5	314
KPCP4010	295	KPDP1510	264	KPRH40125	316	KPRP32125R	314
KPCP4010	313	KPDP1510J5	264	KPRH40125J5	316	KPRP32150	314
KPCP4010J5	295	KPDP1575	264	KPRH40125R	316	KPRP32150J5	314
KPCP4010J5	313	KPDP1575J5	264	KPRH40150	316	KPRP32150R	314
KPCP4010R	295	KPDP1710	264	KPRH40150J5	316	KPRP35125	314
KPCP4010R	313	KPDP1710J5	264	KPRH40150R	316	KPRP35125J5	314
KPCP4075	295	KPDP1775	264	KPRH70125	265	KPRP40125	314
KPCP4075	313	KPDP1775J5	264	KPRH70125J5	265	KPRP40125R	314
KPCP4075J5	295	KPDP2010	264	KPRH70150	265	KPRP40125J5	314
KPCP4075J5	313	KPDP2010J5	264	KPRH70150J5	265	KPRP40125R	314
KPCP4075R	295	KPDP2075	264	KPRH70150R	265	KPRP40150	314
KPCP4075R	313	KPDP2075J5	264	KPRH70150J5	265	KPRP40150J5	314
KPDH1010	264	KPDP22510	264	KPRH70150R	265	KPRP40150R	314
KPDH1010J5	264	KPDP22510J5	313	KPRH70150J5	265	KPS-125	20
KPDH1075	264	KPDP2510J5	264	KPRH70150R	265	KPS-125	36
KPDH1075J5	264	KPDP2510R	313	KPRH70150J5	265	KPS-125	123
KPDH1710	266	KPDP2575	264	KPRH70150R	265	KPS-125	171
KPDH1710J5	266	KPDP2575J5	313	KPRH70150J5	265	KPS-125	188
KPDH1775	266	KPDP2575R	264	KPRH70150R	265	KPS-125	208
KPDH1775J5	266	KPDP3210	313	KPRH70150J5	265	KPS-125	233
KPDH2510	266	KPDP3210J5	313	KPRH70150R	265	KPS-125	234
KPDH2510J5	266	KPDP3210R	313	KPRH70150J5	265	KPS-125	268
KPDH2575	266	KPDP3275	313	KPRH70150R	265	KPS-125	269
KPDH2575J5	266	KPDP3275J5	313	KPRH70150J5	265	KPS-125	297
KPDH4010	315	KPDP3275R	313	KPRH70150R	265	KPS-125	317
KPDH4010J5	315	KPDP3510	313	KPRH70150J5	265	KPS-150	20
KPDH4010R	315	KPDP3510J5	313	KPRH70150R	265	KPS-150	36
KPDH4075	315	KPDP3510R	313	KPRH70150J5	265	KPS-150	123
KPDH4075J5	315	KPDP3575	313	KPRH70150R	265	KPS-150	171
KPDH4075R	315	KPDP3575J5	313	KPRH70150J5	265	KPS-150	188
KPDH7010	264	KPDP3575R	313	KPRH70150R	265	KPS-150	208
KPDH7010J5	264	KPDP4010	313	KPRH70150J5	265	KPS-150	233
KPDH7075	264	KPDP4010J5	313	KPRH70150R	265	KPS-150	234
KPDH7075J5	264	KPDP4075	313	KPRH70150J5	265	KPS-150	268
KPDL1010	262	KPDP4075R	313	KPRH70150R	265	KPS-150	269
KPDL1010J5	262	KPGU400	172	KPRH70150J5	265	KPS-150	297
KPDL1075	262	KPGU400	298	KPRH70150R	265	KPS-150	317
KPDL1075J5	262	KPGU400	318	KPRH70150J5	265	KPSH10125	232
KPDL1510	262	KPR-4HB	298	KPRH70150R	265	KPSH10125J5	232
KPDL1510J5	262	KPR-4HB	318	KPRH70150J5	265	KPSH10125R	232
KPDL1575	262	KPRF400-2	298	KPRH70150R	265	KPSH10125J5	265
KPDL1575J5	262	KPRF400-2	318	KPRH70150J5	265	KPSH10150	232
KPDL2510	311	KPRF400-5	298	KPRH70150R	265	KPSH10150J5	265
KPDL2510J5	311	KPRF400-5	318	KPRH70150J5	265	KPSH10150R	232
KPDL2510R	311	KPRH10125	265	KPRH70150R	265	KPSH10150J5	265
KPDL2575	311	KPRH10125J5	265	KPRH70150J5	265	KPSH10150R	265
KPDL2575J5	311	KPRH10150	265	KPRH70150R	265	KPSH10150J5	265
KPDL2575R	311	KPRH10150J5	265	KPRH70150J5	265	KPSH10150R	265
KPDL4010	311	KPRH10150R	265	KPRH70150R	265	KPSH17125	267
KPDL4010J5	311	KPRH10150J5	265	KPRH70150J5	265	KPSH17125J5	267
KPDL4010R	311	KPRH17125	267	KPRH70150R	265	KPSH17125R	267
KPDL4075	311	KPRH17125J5	267	KPRH70150J5	265	KPSH17150	267
KPDL4075J5	311	KPRH17125R	267	KPRH70150R	265	KPSH17150J5	267
KPDL4075R	311	KPRH17125J5	267	KPRH70150J5	265	KPSH25125	267
KPDL5010	262	KPRH17125R	267	KPRH70150R	265	KPSH25125J5	267
KPDL5010J5	262	KPRH17150	267	KPRH70150J5	265	KPSH25150	267
KPDL5075	262	KPRH17150J5	267	KPRH70150R	265	KPSH25150J5	267
KPDL5075J5	262	KPRH17150R	267	KPRH70150J5	265	KPSH25150R	267
		KPRH17150J5	267	KPRH70150R	265	KPSH40125	316
				KPRH70150J5	265	KPSH40125J5	316

Alphanumeric Index

Catalog Number	Page	Catalog Number	Page	Catalog Number	Page	Catalog Number	Page
KPSH40125R	316	KPSL70125J5	230	KPSP35125	296	KPSTL15150	230
KPSH40150	316	KPSL70125J5	263	KPSP35125	314	KPSTL15150J5	230
KPSH40150J5	316	KPSL70150	230	KPSP35125J5	296	KPSTL25125	294
KPSH40150R	316	KPSL70150	263	KPSP35125J5	314	KPSTL25125J5	294
KPSH70125	232	KPSL70150J5	230	KPSP35125R	296	KPSTL25125R	294
KPSH70125	265	KPSL70150J5	263	KPSP35125R	314	KPSTL25150	294
KPSH70125J5	232	KPSP15125	232	KPSP35150	296	KPSTL25150J5	294
KPSH70125J5	265	KPSP15125	265	KPSP35150	314	KPSTL25150R	294
KPSH70150	232	KPSP15125J5	232	KPSP35150J5	296	KPSTL40125	294
KPSH70150	265	KPSP15125J5	265	KPSP35150J5	314	KPSTL40125J5	294
KPSH70150J5	232	KPSP15150	232	KPSP35150R	296	KPSTL40125R	294
KPSH70150J5	265	KPSP15150	265	KPSP35150R	314	KPSTL40150	294
KPSL10125	230	KPSP15150J5	232	KPSP40125	296	KPSTL40150J5	294
KPSL10125	263	KPSP15150J5	265	KPSP40125	314	KPSTL40150R	294
KPSL10125J5	230	KPSP17125	232	KPSP40125J5	296	KPSTL40150J5	230
KPSL10125J5	263	KPSP17125	265	KPSP40125J5	314	KPSTL50125J5	230
KPSL10150	230	KPSP17125J5	232	KPSP40125R	296	KPSTL50150	230
KPSL10150	263	KPSP17125J5	265	KPSP40125R	314	KPSTL50150J5	230
KPSL10150J5	230	KPSP17150	232	KPSP40150	296	KPSTL70125	230
KPSL10150J5	263	KPSP17150	265	KPSP40150	314	KPSTL70125J5	230
KPSL15125	230	KPSP17150J5	232	KPSP40150J5	296	KPSTL70150	230
KPSL15125	263	KPSP17150J5	265	KPSP40150J5	314	KPSTL70150J5	230
KPSL15125J5	230	KPSP20125	232	KPSP40150R	296	KPSTP15125	232
KPSL15125J5	263	KPSP20125	265	KPSP40150R	314	KPSTP15125J5	232
KPSL15150	230	KPSP20125J5	232	KPST-125	20	KPSTP15150	232
KPSL15150	263	KPSP20125J5	265	KPST-125	36	KPSTP15150J5	232
KPSL15150J5	230	KPSP20150	232	KPST-125	123	KPSTP17125	232
KPSL15150J5	263	KPSP20150	265	KPST-125	171	KPSTP17125J5	232
KPSL25125	294	KPSP20150J5	232	KPST-125	188	KPSTP17150	232
KPSL25125	312	KPSP20150J5	265	KPST-125	208	KPSTP17150J5	232
KPSL25125J5	294	KPSP25125	232	KPST-125	233	KPSTP20125	232
KPSL25125J5	312	KPSP25125	265	KPST-125	234	KPSTP20125J5	232
KPSL25125R	294	KPSP25125	296	KPST-125	268	KPSTP20150	232
KPSL25125R	312	KPSP25125	314	KPST-125	269	KPSTP20150J5	232
KPSL25150	294	KPSP25125J5	232	KPST-125	297	KPSTP25125	232
KPSL25150	312	KPSP25125J5	265	KPST-125	317	KPSTP25125	296
KPSL25150J5	294	KPSP25125J5	296	KPST-150	20	KPSTP25125J5	232
KPSL25150J5	312	KPSP25125J5	314	KPST-150	36	KPSTP25125J5	296
KPSL25150R	294	KPSP25125R	296	KPST-150	123	KPSTP25125R	296
KPSL25150R	312	KPSP25125R	314	KPST-150	171	KPSTP25150	232
KPSL40125	294	KPSP25150	232	KPST-150	188	KPSTP25150	296
KPSL40125	312	KPSP25150	265	KPST-150	208	KPSTP25150J5	232
KPSL40125J5	294	KPSP25150	296	KPST-150	233	KPSTP25150J5	296
KPSL40125J5	312	KPSP25150	314	KPST-150	234	KPSTP25150R	296
KPSL40125R	294	KPSP25150J5	232	KPST-150	268	KPSTP32125	296
KPSL40125R	312	KPSP25150J5	265	KPST-150	269	KPSTP32125J5	296
KPSL40150	294	KPSP25150J5	296	KPST-150	297	KPSTP32125R	296
KPSL40150	312	KPSP25150J5	314	KPST-150	317	KPSTP32150	296
KPSL40150J5	294	KPSP25150R	296	KPSTH10125	232	KPSTP32150J5	296
KPSL40150J5	312	KPSP25150R	314	KPSTH10125J5	232	KPSTP32150R	296
KPSL40150R	294	KPSP32125	296	KPSTH10150	232	KPSTP35125	296
KPSL40150R	312	KPSP32125	314	KPSTH10150J5	232	KPSTP35125J5	296
KPSL50125	230	KPSP32125J5	296	KPSTH70125	232	KPSTP35125R	296
KPSL50125	263	KPSP32125J5	314	KPSTH70125J5	232	KPSTP35150	296
KPSL50125J5	230	KPSP32125R	296	KPSTH70150	232	KPSTP35150J5	296
KPSL50125J5	263	KPSP32125R	314	KPSTH70150J5	232	KPSTP35150R	296
KPSL50150	230	KPSP32150	296	KPSTL10125	230	KPSTP40125	296
KPSL50150	263	KPSP32150	314	KPSTL10125J5	230	KPSTP40125J5	296
KPSL50150J5	230	KPSP32150J5	296	KPSTL10150	230	KPSTP40125R	296
KPSL50150J5	263	KPSP32150J5	314	KPSTL10150J5	230	KPSTP40150	296
KPSL70125	230	KPSP32150R	296	KPSTL15125	230	KPSTP40150J5	296
KPSL70125	263	KPSP32150R	314	KPSTL15125J5	230	KPSTP40150R	296

Alphanumeric Index

Catalog Number	Page	Catalog Number	Page	Catalog Number	Page	Catalog Number	Page
KPWB-100	20	KPWB1510J5	232	KPWL1010J5	263	KPWP4010J5	314
KPWB-100	36	KPWB1575	232	KPWL1075	263	KPWP4010R	314
KPWB-100	123	KPWB1575J5	232	KPWL1075J5	263	KPWP4075	314
KPWB-100	171	KPWB1710	232	KPWL1510	263	KPWP4075J5	314
KPWB-100	188	KPWB1710J5	232	KPWL1510J5	263	KPWP4075R	314
KPWB-100	208	KPWB1775	232	KPWL1575	263	KR2-AN	190
KPWB-100	233	KPWB1775J5	232	KPWL1575J5	263	KR2-AN	210
KPWB-100	234	KPWB2010	232	KPWL2510	312	KR2-AN	233
KPWB-100	268	KPWB2010J5	232	KPWL2510J5	312	KR2-AN	238
KPWB-100	269	KPWB2075	232	KPWL2510R	312	KR2-AN	268
KPWB-100	297	KPWB2075J5	232	KPWL2575	312	KR2-AN	273
KPWB-100	317	KPWB2510	232	KPWL2575J5	312	KR2-AN	333
KPWB-75	20	KPWB2510J5	296	KPWL2575R	312	KR2-AN	369
KPWB-75	36	KPWB2510J5	232	KPWL4010	312	KR2-AN	381
KPWB-75	123	KPWB2510J5	296	KPWL4010J5	312	KR2-AN	501
KPWB-75	171	KPWB2510R	296	KPWL4010R	312	KR2-AN	618
KPWB-75	188	KPWB2575	232	KPWL4075	312	KR2-DD	190
KPWB-75	208	KPWB2575	296	KPWL4075J5	312	KR2-DD	210
KPWB-75	233	KPWB2575J5	232	KPWL4075R	312	KR2-DD	238
KPWB-75	234	KPWB2575J5	296	KPWL5010	263	KR2-DD	273
KPWB-75	268	KPWB2575R	296	KPWL5010J5	263	KR2-ST	190
KPWB-75	269	KPWB3210	296	KPWL5075	263	KR2-ST	210
KPWB-75	297	KPWB3210J5	296	KPWL5075J5	263	KR2-ST	233
KPWB-75	317	KPWB3210R	296	KPWL7010	263	KR2-ST	238
KPWBH1010	232	KPWB3275	296	KPWL7010J5	263	KR2-ST	268
KPWBH1010J5	232	KPWB3275J5	296	KPWL7075	263	KR2-ST	273
KPWBH1075	232	KPWB3275R	296	KPWL7075J5	263	KR2-ST	333
KPWBH1075J5	232	KPWB3510	296	KPWP1510	265	KR2-ST	369
KPWBH7010	232	KPWB3510J5	296	KPWP1510J5	265	KR2-ST	381
KPWBH7010J5	232	KPWB3510R	296	KPWP1575	265	KR2-ST	501
KPWBH7075	232	KPWB3575	296	KPWP1575J5	265	KR2-ST	618
KPWBH7075J5	232	KPWB3575J5	296	KPWP1710	265	KRF-GK	21
KPWBL1010	230	KPWB3575R	296	KPWP1710J5	265	KRF-GK	37
KPWBL1010J5	230	KPWB4010	296	KPWP1775	265	KRF-GK	124
KPWBL1075	230	KPWB4010J5	296	KPWP1775J5	265	KRF-GK	190
KPWBL1075J5	230	KPWB4010R	296	KPWP2010	265	KRF-GK	210
KPWBL1510	230	KPWB4075	296	KPWP2010J5	265	KRF-GK	238
KPWBL1510J5	230	KPWB4075J5	296	KPWP2075	265	KRF-GK	273
KPWBL1575	230	KPWB4075R	296	KPWP2075J5	265	KRF-GK	333
KPWBL1575J5	230	KPWH1010	265	KPWP2510	265	KRG2	21
KPWBL2510	294	KPWH1010J5	265	KPWP2510	314	KRG2	38
KPWBL2510J5	294	KPWH1075	265	KPWP2510J5	265	KRG2	125
KPWBL2510R	294	KPWH1075J5	265	KPWP2510J5	314	KRG2	190
KPWBL2575	294	KPWH1710	267	KPWP2510R	314	KRG2	210
KPWBL2575J5	294	KPWH1710J5	267	KPWP2575	265	KRG2	238
KPWBL2575R	294	KPWH1775	267	KPWP2575	314	KRG2	273
KPWBL4010	294	KPWH1775J5	267	KPWP2575J5	265	KRGU2	381
KPWBL4010J5	294	KPWH2510	267	KPWP2575J5	314	LDBH25AG2XJ	658
KPWBL4010R	294	KPWH2510J5	267	KPWP2575R	314	LDBI30AG2	658
KPWBL4075	294	KPWH2575	267	KPWP3210	314	LDBL10AG2XJ	658
KPWBL4075J5	294	KPWH2575J5	267	KPWP3210J5	314	LDBL15AG2XJ	658
KPWBL4075R	294	KPWH4010	316	KPWP3210R	314	LDBL25AG2XJ	658
KPWBL5010	230	KPWH4010J5	316	KPWP3275	314	LDBM25AG2XJ	658
KPWBL5010J5	230	KPWH4010R	316	KPWP3275J5	314	LDBQ85AG2BJ	658
KPWBL5075	230	KPWH4075	316	KPWP3275R	314	LDER1P	651
KPWBL5075J5	230	KPWH4075J5	316	KPWP3510	314	LDER1P	654
KPWBL7010	230	KPWH4075R	316	KPWP3510J5	314	LDER27	659
KPWBL7010J5	230	KPWH7010	265	KPWP3510R	314	LDER2P	659
KPWBL7075	230	KPWH7010J5	265	KPWP3575	314	LDGH25AG2XJ	658
KPWBL7075J5	230	KPWH7075	265	KPWP3575J5	314	LDGHBZ	659
KPWB-M20	20	KPWH7075J5	265	KPWP3575R	314	LDGI30AG2	658
KPWBP1510	232	KPWL1010	263	KPWP4010	314	LDGL10AG2XJ	658

Alphanumeric Index

Catalog Number	Page	Catalog Number	Page	Catalog Number	Page	Catalog Number	Page
LDGL15AG2XJ	658	LLEDA3L5BUZ2	63	LN2SL154G2XJ	377	LPAL1575	329
LDGL25AG2XJ	658	LLEDA3L7BUZ2	63	LN2WH15AG2XJ	380	LPAL1575J	329
LDGM25AG2XJ	658	LLEDA3S2BUZ2	63	LN2WL10AG2XJ	377	LPAL1575R	329
LDGQ85AG2BJ	658	LLEDA3S5BUZ2	63	LN2WL15AG2XJ	377	LPAL5010	329
LDGSBZ	659	LLEDA3S7BUZ2	63	LN3AH252G4XJ	380	LPAL5010J	329
LDMF18AG1	653	LLEDA3T2BUZ2	63	LN3AL252G4XJ	377	LPAL5010R	329
LDMH15AG1XJ	653	LLEDA3T5BUZ2	63	LN3AM252G4XJ	379	LPAL5075	329
LDMHBZ	589	LLEDA3T7BUZ2	63	LN3CH25AG4XJ	380	LPAL5075J	329
LDMHBZ	654	LLEDBH	53	LN3CL25AG4XJ	377	LPAL5075R	329
LDM20AG1	653	LLEDBU2	53	LN3CM25AG4XJ	379	LPAL7010	329
LDML15AG1XJ	653	LLEDBU2	66	LN3DH252G4XJ	380	LPAL7010J	329
LDML70AG1XJ	653	LLEDBU2	99	LN3DL252G4XJ	377	LPAL7010R	329
LDMM12AG1XJ	653	LLEDCPL	53	LN3DM252G4XJ	379	LPAL7075	329
LDMM80AG1XJ	653	LLEDCPL	66	LN3RH254G4XJ	380	LPAL7075J	329
LDM5BA	654	LLEDCPL	99	LN3RL254G4XJ	377	LPAL7075R	329
LDP1075	651	LLEDDPL	53	LN3RM254G4XJ	379	LPAP1510	330
LDP2075	651	LLEDDPL	99	LN3SH254G4XJ	380	LPAP1510J	330
LDP2M20	651	LLEDRB	66	LN3SL254G4XJ	377	LPAP1510R	330
LDPG1Z	589	LLEDSC	53	LN3SM254G4XJ	379	LPAP1575	330
LDPG1Z	654	LLEDSC	66	LN3WH25AG4XJ	380	LPAP1575J	330
LDPG27	659	LLEDSC	99	LN3WL25AG4XJ	377	LPAP1575R	330
LDPG3Z	586	LM400E40	434	LN3WM25AG4XJ	379	LPAP1710	330
LDPG3Z	651	LM400E40	438	LN4AH402G4XJ	380	LPAP1710J	330
LDPHBZ	586	LM400E40	442	LN4AL402G4XJ	377	LPAP1710R	330
LDPHBZ	651	LN1AL702G2XJ	377	LN4AM402G4XJ	379	LPAP1775	330
LDRBM10Z	589	LN1AM122G2XJ	379	LN4CH40AG4XJ	380	LPAP1775J	330
LDRBM10Z	654	LN1AZ102G2	378	LN4CL40AG4XJ	377	LPAP1775R	330
LDRBM10Z	659	LN1AZ152G2	378	LN4CM40AG4XJ	379	LPAP2010	330
LDRBM16Z	659	LN1CL70AG2XJ	377	LN4DH402G4XJ	380	LPAP2010J	330
LDRH40AG2XJ	658	LN1CM12AG2XJ	379	LN4DL402G4XJ	377	LPAP2010R	330
LDRHBZ	659	LN1CZ10AG2	378	LN4DM402G4XJ	379	LPAP2075	330
LDRL40AG2XJ	658	LN1CZ15AG2	378	LN4RH404G4XJ	380	LPAP2075J	330
LDRSBZ	659	LN1DL702G2XJ	377	LN4RL404G4XJ	377	LPAP2075R	330
LF008G5	567	LN1DM122G2XJ	379	LN4RM404G4XJ	379	LPB100H	331
LLEDA12BH2	51	LN1DZ102G2	378	LN4SH404G4XJ	380	LPB100L	331
LLEDA12BH2D	51	LN1DZ152G2	378	LN4SL404G4XJ	377	LPB150L	331
LLEDA12LU2	51	LN1RL704G2XJ	377	LN4SM404G4XJ	379	LPB150P	331
LLEDA12LU2D	51	LN1RM124G2XJ	379	LN4WH40AG4XJ	380	LPB175P	331
LLEDA12LU2DH	94	LN1RZ104G2	378	LN4WL40AG4XJ	377	LPB200P	331
LLEDA12LU2H	94	LN1RZ154G2	378	LN4WM40AG4XJ	379	LPB50L	331
LLEDA15BH2	51	LN1SL704G2XJ	377	LPA-100	331	LPB70L	331
LLEDA15BH2D	51	LN1SM124G2XJ	379	LPA-75	331	LPBG-12	333
LLEDA15LU2	51	LN1SZ104G2	378	LPAD-1	125	LPBG-8	346
LLEDA15LU2D	51	LN1SZ154G2	378	LPAD-1	38	LPBH100R	331
LLEDA15LU2DH	94	LN1WL70AG2XJ	377	LPAD-1	238	LPBLH100R	331
LLEDA15LU2H	94	LN1WM12AG2XJ	379	LPAD-1	273	LPBLH150R	331
LLEDA17BH2	51	LN1WZ10AG2	378	LPAD-1	331	LPBLH50R	331
LLEDA17BH2D	51	LN1WZ15AG2	378	LPAH1010	330	LPBLH70R	331
LLEDA17LU2	51	LN2AH152G2XJ	380	LPAH1010J	330	LPBP150R	331
LLEDA17LU2D	51	LN2AL102G2XJ	377	LPAH1010R	330	LPBP175R	331
LLEDA17LU2DH	94	LN2AL152G2XJ	377	LPAH1075	330	LPBP200R	331
LLEDA17LU2H	94	LN2CH15AG2XJ	380	LPAH1075J	330	LPC-100	331
LLEDA2L2BUZ2	63	LN2CL10AG2XJ	377	LPAH1075R	330	LPC-75	331
LLEDA2L5BUZ2	63	LN2CL15AG2XJ	377	LPAL1010	329	LPCH1010	330
LLEDA2L7BUZ2	63	LN2DH152G2XJ	380	LPAL1010J	329	LPCH1010J	330
LLEDA2S2BUZ2	63	LN2DL102G2XJ	377	LPAL1010R	329	LPCH1010R	330
LLEDA2S5BUZ2	63	LN2DL152G2XJ	377	LPAL1075	329	LPCH1075	330
LLEDA2S7BUZ2	63	LN2RH154G2XJ	380	LPAL1075J	329	LPCH1075J	330
LLEDA2T2BUZ2	63	LN2RL104G2XJ	377	LPAL1075R	329	LPCH1075R	330
LLEDA2T5BUZ2	63	LN2RL154G2XJ	377	LPAL1510	329	LPCL1010	329
LLEDA2T7BUZ2	63	LN2SH154G2XJ	380	LPAL1510J	329	LPCL1010J	329
LLEDA3L2BUZ2	63	LN2SL104G2XJ	377	LPAL1510R	329	LPCL1010R	329

Alphanumeric Index

Catalog Number	Page	Catalog Number	Page	Catalog Number	Page	Catalog Number	Page
LPCL1075	329	LPR-25AN	346	LPSP15125R	330	LPWBP2010R	330
LPCL1075J	329	LPR-25ST	346	LPSP15150	330	LPWBP2075	330
LPCL1075R	329	LPRF-2CG	332	LPSP15150J	330	LPWBP2075J	330
LPCL1510	329	LPRF-2CP	190	LPSP15150R	330	LPWBP2075R	330
LPCL1510J	329	LPRF-2CP	210	LPSP17125	330	M175	746
LPCL1510R	329	LPRF-2CP	237	LPSP17125J	330	M176	746
LPCL1575	329	LPRF-2CP	272	LPSP17125R	330	M180	746
LPCL1575J	329	LPRF-2CP	332	LPSP17150	330	MA1010-120	343
LPCL1575R	329	LPRF-3CP	190	LPSP17150J	330	MA1010J-120	343
LPCL5010	329	LPRF-3CP	210	LPSP17150R	330	MA1075-120	343
LPCL5010J	329	LPRF-3CP	237	LPSP20125	330	MA1075J-120	343
LPCL5010R	329	LPRF-3CP	272	LPSP20125J	330	MA1510-120	343
LPCL5075	329	LPRF-3CP	332	LPSP20125R	330	MA1510J-120	343
LPCL5075J	329	LPRF-4CP	190	LPSP20150	330	MA1575-120	343
LPCL5075R	329	LPRF-4CP	210	LPSP20150J	330	MA1575J-120	343
LPCL7010	329	LPRF-4CP	237	LPSP20150R	330	MA3510-120	343
LPCL7010J	329	LPRF-4CP	272	LPWB-100	331	MA3510J-120	343
LPCL7010R	329	LPRF-4CP	332	LPWB-75	331	MA3575-120	343
LPCL7075	329	LPRF-5CG	332	LPWBH1010	330	MA3575J-120	343
LPCL7075J	329	LPRF-5CG	333	LPWBH1010J	330	MA5010-120	343
LPCL7075R	329	LPRF-5CP	190	LPWBH1010R	330	MA5010J-120	343
LPCL7075R	329	LPRF-5CP	210	LPWBH1075	330	MA5075-120	343
LPCP1510	330	LPRF-5CP	237	LPWBH1075J	330	MA5075J-120	343
LPCP1510J	330	LPRF-5CP	272	LPWBH1075R	330	MA7010-120	343
LPCP1575	330	LPRF-5CP	332	LPWBL1010	329	MA7010J-120	343
LPCP1575J	330	LPRG-2	333	LPWBL1010J	329	MA7075-120	343
LPCP1575R	330	LPRP-25AN	346	LPWBL1010R	329	MA7075J-120	343
LPCP1710	330	LPRP-25ST	346	LPWBL1075	329	MBL100-120	344
LPCP1710J	330	LPS-125	331	LPWBL1075J	329	MBL150-120	344
LPCP1710R	330	LPS-150	331	LPWBL1075R	329	MBL35-120	344
LPCP1775	330	LPSH1010	330	LPWBL1510	329	MBL50-120	344
LPCP1775J	330	LPSH1010J	330	LPWBL1510J	329	MBL70-120	344
LPCP1775R	330	LPSH1010R	330	LPWBL1510R	329	MC1010-120	343
LPCP2010	330	LPSH1075	330	LPWBL1575	329	MC1010J-120	343
LPCP2010J	330	LPSH1075J	330	LPWBL1575J	329	MC1075-120	343
LPCP2010R	330	LPSH1075R	330	LPWBL1575R	329	MC1075J-120	343
LPCP2075	330	LPSL10125	329	LPWBL5010	329	MC1510-120	343
LPCP2075J	330	LPSL10125J	329	LPWBL5010J	329	MC1510J-120	343
LPCP2075R	330	LPSL10125R	329	LPWBL5010R	329	MC1575-120	343
LPG-R1	190	LPSL10150	329	LPWBL5075	329	MC1575J-120	343
LPG-R1	210	LPSL10150J	329	LPWBL5075J	329	MC3510-120	343
LPG-R1	237	LPSL10150R	329	LPWBL5075R	329	MC3510J-120	343
LPG-R1	272	LPSL15125	329	LPWBL7010	329	MC3575-120	343
LPG-R1	332	LPSL15125J	329	LPWBL7010J	329	MC3575J-120	343
LPG-R1	333	LPSL15125R	329	LPWBL7010R	329	MC5010-120	343
LPG-R3	190	LPSL15150	329	LPWBL7075	329	MC5010J-120	343
LPG-R3	210	LPSL15150J	329	LPWBL7075J	329	MC5075-120	343
LPG-R3	237	LPSL15150R	329	LPWBL7075R	329	MC5075J-120	343
LPG-R3	272	LPSL50125	329	LPWBP1510	330	MC7010-120	343
LPG-R3	332	LPSL50125J	329	LPWBP1510J	330	MC7010J-120	343
LPG-R3	333	LPSL50125R	329	LPWBP1510R	330	MC7075-120	343
LPG-R5	21	LPSL50150	329	LPWBP1575	330	MC7075J-120	343
LPG-R5	37	LPSL50150J	329	LPWBP1575J	330	MCG2250	719
LPG-R5	124	LPSL50150R	329	LPWBP1575R	330	MGSW10-120	343
LPG-R5	190	LPSL70125	329	LPWBP1710	330	MGSW10J-120	343
LPG-R5	210	LPSL70125J	329	LPWBP1710J	330	MGSW15-120	343
LPG-R5	237	LPSL70125R	329	LPWBP1710R	330	MGSW15J-120	343
LPG-R5	272	LPSL70150	329	LPWBP1775	330	MGSW35-120	343
LPG-R5	332	LPSL70150J	329	LPWBP1775J	330	MGSW35J-120	343
LPG-R5	333	LPSL70150R	329	LPWBP1775R	330	MGSW50-120	343
LPJR-2CG	346	LPSP15125	330	LPWBP2010	330	MGSW50J-120	343
LPJR-5CG	346	LPSP15125J	330	LPWBP2010J	330	MGSW70-120	343

Alphanumeric Index

Catalog Number	Page	Catalog Number	Page	Catalog Number	Page	Catalog Number	Page
MGSW70J-120	343	MLAH102J5N	186	MLAP172G1N	186	MLCF323G2N	461
MGU1	21	MLAH102J5N	206	MLAP172G1N	206	MLCF323J5N	461
MGU1	38	MLAH103G1N	186	MLAP172J5N	186	MLCH102G1N	186
MGU1	125	MLAH103G1N	206	MLAP172J5N	206	MLCH102G1N	206
MJBW10-120	343	MLAH103J5N	186	MLAP173G1N	186	MLCH102J5N	186
MJBW10J-120	343	MLAH103J5N	206	MLAP173G1N	206	MLCH102J5N	206
MJBW15-120	343	MLAH502G1N	186	MLAP173J5N	186	MLCH103G1N	186
MJBW15J-120	343	MLAH502G1N	206	MLAP173J5N	206	MLCH103G1N	206
MJBW35-120	343	MLAH502J5N	186	MLAQ852G4N	169	MLCH103J5N	186
MJBW35J-120	343	MLAH502J5N	206	MLAQ853G4N	169	MLCH103J5N	206
MJBW50-120	343	MLAH503G1N	186	MLBG10H	189	MLCH502G1N	186
MJBW50J-120	343	MLAH503G1N	206	MLBG10H	209	MLCH502G1N	206
MJBW70-120	343	MLAH503J5N	186	MLBG10L	189	MLCH502J5N	186
MJBW70J-120	343	MLAH503J5N	206	MLBG10L	209	MLCH502J5N	206
MLAF1142G4N	460	MLAH702G1N	186	MLBG15I	189	MLCH503G1N	186
MLAF1142J5N	460	MLAH702G1N	206	MLBG15I	209	MLCH503G1N	206
MLAF1142P5N	460	MLAH702J5N	186	MLBG15L	189	MLCH503J5N	186
MLAF1143G4N	460	MLAH702J5N	206	MLBG15L	209	MLCH503J5N	206
MLAF1143J5N	460	MLAH703G1N	186	MLBG15P	189	MLCH702G1N	186
MLAF1143P5N	460	MLAH703G1N	206	MLBG15P	209	MLCH702G1N	206
MLAF262G2N	460	MLAH703J5N	186	MLBG17H	209	MLCH702J5N	186
MLAF262J5N	460	MLAH703J5N	206	MLBG17P	189	MLCH702J5N	206
MLAF262P5N	460	MLAL102G1N	184	MLBG17P	209	MLCH703G1N	186
MLAF263G2N	460	MLAL102G1N	204	MLBG50H	189	MLCH703G1N	206
MLAF263J5N	460	MLAL102J5N	184	MLBG50H	209	MLCH703J5N	186
MLAF263P5N	460	MLAL102J5N	204	MLBG50L	189	MLCH703J5N	206
MLAF322G2N	460	MLAL103G1N	184	MLBG50L	209	MLCL102G1N	184
MLAF322J5N	460	MLAL103G1N	204	MLBG70H	189	MLCL102G1N	204
MLAF322P5N	460	MLAL103J5N	184	MLBG70H	209	MLCL102J5N	184
MLAF323G2N	460	MLAL103J5N	204	MLBG70L	189	MLCL102J5N	204
MLAF323J5N	460	MLAL152G1N	184	MLBG70L	209	MLCL103G1N	184
MLAF323P5N	460	MLAL152G1N	204	MLBR10H	189	MLCL103G1N	204
MLAF422G2N	460	MLAL152J5N	184	MLBR10H	209	MLCL103J5N	184
MLAF422J5N	460	MLAL152J5N	204	MLBR10L	189	MLCL103J5N	204
MLAF422P5N	460	MLAL153G1N	184	MLBR10L	209	MLCL152G1N	184
MLAF423G2N	460	MLAL153G1N	204	MLBR15I	189	MLCL152G1N	204
MLAF423J5N	460	MLAL153J5N	184	MLBR15I	209	MLCL152J5N	184
MLAF423P5N	460	MLAL153J5N	204	MLBR15L	189	MLCL152J5N	204
MLAF522G2N	460	MLAL502G1N	184	MLBR15L	209	MLCL153G1N	184
MLAF522J5N	460	MLAL502G1N	204	MLBR15P	189	MLCL153G1N	204
MLAF522P5N	460	MLAL502J5N	184	MLBR15P	209	MLCL153J5N	184
MLAF523G2N	460	MLAL502J5N	204	MLBR17H	209	MLCL153J5N	204
MLAF523J5N	460	MLAL503G1N	184	MLBR17P	189	MLCL502G1N	184
MLAF523P5N	460	MLAL503G1N	204	MLBR17P	209	MLCL502G1N	204
MLAF572G4N	460	MLAL503J5N	184	MLBR50H	189	MLCL502J5N	184
MLAF572J5N	460	MLAL503J5N	204	MLBR50H	209	MLCL502J5N	204
MLAF572P5N	460	MLAL702G1N	184	MLBR50L	189	MLCL503G1N	184
MLAF573G4N	460	MLAL702G1N	204	MLBR50L	209	MLCL503G1N	204
MLAF642G2N	460	MLAL702J5N	184	MLBR70H	189	MLCL503J5N	184
MLAF642J5N	460	MLAL702J5N	204	MLBR70H	209	MLCL503J5N	204
MLAF642P5N	460	MLAL703G1N	184	MLBR70L	189	MLCL702G1N	184
MLAF643G2N	460	MLAL703G1N	204	MLBR70L	209	MLCL702G1N	204
MLAF643J5N	460	MLAL703J5N	184	MLBRG485Q	172	MLCL702J5N	184
MLAF643P5N	460	MLAL703J5N	204	MLCF262G2N	461	MLCL702J5N	204
MLAF842G2N	460	MLAP152G1N	186	MLCF262J5N	461	MLCL703G1N	184
MLAF842J5N	460	MLAP152G1N	206	MLCF262P5N	461	MLCL703G1N	204
MLAF842P5N	460	MLAP152J5N	186	MLCF263G2N	461	MLCL703J5N	184
MLAF843G2N	460	MLAP152J5N	206	MLCF263J5N	461	MLCL703J5N	204
MLAF843J5N	460	MLAP153G1N	186	MLCF263P5N	461	MLCP152G1N	186
MLAF843P5N	460	MLAP153G1N	206	MLCF322G2N	461	MLCP152G1N	206
MLAH102G1N	186	MLAP153J5N	186	MLCF322J5N	461	MLCP152J5N	186
MLAH102G1N	206	MLAP153J5N	206	MLCF322P5N	461	MLCP152J5N	206

Alphanumeric Index

Catalog Number	Page	Catalog Number	Page	Catalog Number	Page	Catalog Number	Page
MLCP153G1N	186	MLDH102G1N	186	MLDP153J5N	186	MLEDNC173P5	16
MLCP153G1N	206	MLDH102G1N	206	MLDP153J5N	206	MLEDNC252P5	16
MLCP153J5N	186	MLDH102J5N	186	MLDP172G1N	186	MLEDNC253P5	16
MLCP153J5N	206	MLDH102J5N	206	MLDP172G1N	206	MLEDNC352P5	16
MLCP172G1N	186	MLDH103G1N	186	MLDP172J5N	186	MLEDNC353P5	16
MLCP172G1N	206	MLDH103G1N	206	MLDP172J5N	206	MLEDNC402P5	16
MLCP172J5N	186	MLDH103J5N	186	MLDP173G1N	186	MLEDNC403P5	16
MLCP172J5N	206	MLDH103J5N	206	MLDP173G1N	206	MLEDNC702P5	16
MLCP173G1N	186	MLDH502G1N	186	MLDP173J5N	186	MLEDNC703P5	16
MLCP173G1N	206	MLDH502G1N	206	MLDP173J5N	206	MLEDND102P1	15
MLCP173J5N	186	MLDH502J5N	186	MLDQ852G4N	169	MLEDND102P5	15
MLCP173J5N	206	MLDH502J5N	206	MLDQ853G4N	169	MLEDND103P1	15
MLCQ852G4N	169	MLDH503G1N	186	MLEDN10A1W	21	MLEDND103P5	15
MLCQ853G4N	169	MLDH503G1N	206	MLEDN10A5W	21	MLEDND152P5	15
MLDF1142G4N	460	MLDH503J5N	186	MLEDN10P1	18	MLEDND153P5	15
MLDF1142J5N	460	MLDH503J5N	206	MLEDN10P5	18	MLEDND172P1	15
MLDF1142P5N	460	MLDH702G1N	186	MLEDN15A5W	21	MLEDND172P5	15
MLDF1143G4N	460	MLDH702G1N	206	MLEDN15P5	18	MLEDND173P1	15
MLDF1143J5N	460	MLDH702J5N	186	MLEDN17A1W	21	MLEDND173P5	15
MLDF1143P5N	460	MLDH702J5N	206	MLEDN17A5W	21	MLEDND252P5	15
MLDF262G2N	460	MLDH703G1N	186	MLEDN17P1	18	MLEDND253P5	15
MLDF262J5N	460	MLDH703G1N	206	MLEDN17P5	18	MLEDND353P5	15
MLDF262P5N	460	MLDH703J5N	186	MLEDN25A5W	21	MLEDND403P5	15
MLDF263G2N	460	MLDH703J5N	206	MLEDN25P5	18	MLEDND702P5	15
MLDF263J5N	460	MLDL102G1N	184	MLEDN35A5W	21	MLEDND703P5	15
MLDF263P5N	460	MLDL102G1N	204	MLEDN35P5	18	MLEDNDBH	21
MLDF322G2N	460	MLDL102J5N	184	MLEDN40A5W	21	MLEDNDBU	21
MLDF322J5N	460	MLDL102J5N	204	MLEDN40P5	18	MLEDNDBU40	21
MLDF322P5N	460	MLDL103G1N	184	MLEDN70A5W	21	MLEDNR104P1	17
MLDF323G2N	460	MLDL103G1N	204	MLEDN70P5	18	MLEDNR104P5	17
MLDF323J5N	460	MLDL103J5N	184	MLEDNA102P1	15	MLEDNR105P1	17
MLDF323P5N	460	MLDL103J5N	204	MLEDNA102P5	15	MLEDNR105P5	17
MLDF422G2N	460	MLDL152G1N	184	MLEDNA103P1	15	MLEDNR154P5	17
MLDF422J5N	460	MLDL152G1N	204	MLEDNA103P5	15	MLEDNR155P5	17
MLDF422P5N	460	MLDL152J5N	184	MLEDNA10P5	19	MLEDNR174P1	17
MLDF423G2N	460	MLDL152J5N	204	MLEDNA152P5	15	MLEDNR174P5	17
MLDF423J5N	460	MLDL153G1N	184	MLEDNA153P5	15	MLEDNR175P1	17
MLDF423P5N	460	MLDL153G1N	204	MLEDNA15P5	19	MLEDNR175P5	17
MLDF522G2N	460	MLDL153J5N	184	MLEDNA172P1	15	MLEDNR254P5	17
MLDF522J5N	460	MLDL153J5N	204	MLEDNA172P5	15	MLEDNR255P5	17
MLDF522P5N	460	MLDL502G1N	184	MLEDNA173P1	15	MLEDNR354P5	17
MLDF523G2N	460	MLDL502G1N	204	MLEDNA173P5	15	MLEDNR355P5	17
MLDF523J5N	460	MLDL502J5N	184	MLEDNA17P5	19	MLEDNR404P5	17
MLDF523P5N	460	MLDL502J5N	204	MLEDNA252P5	15	MLEDNR405P5	17
MLDF572G4N	460	MLDL503G1N	184	MLEDNA253P5	15	MLEDNR704P5	17
MLDF572J5N	460	MLDL503G1N	204	MLEDNA25P5	19	MLEDNR705P5	17
MLDF572P5N	460	MLDL503J5N	184	MLEDNA352P5	15	MLEDNS104P1	17
MLDF573G4N	460	MLDL503J5N	204	MLEDNA353P5	15	MLEDNS104P5	17
MLDF573J5N	460	MLDL702G1N	184	MLEDNA402P5	15	MLEDNS105P1	17
MLDF573P5N	460	MLDL702G1N	204	MLEDNA403P5	15	MLEDNS105P5	17
MLDF642G2N	460	MLDL702J5N	184	MLEDNA702P5	15	MLEDNS154P5	17
MLDF642J5N	460	MLDL702J5N	204	MLEDNA703P5	15	MLEDNS155P5	17
MLDF642P5N	460	MLDL703G1N	184	MLEDNA70P5	19	MLEDNS174P1	17
MLDF643G2N	460	MLDL703G1N	204	MLEDNC102P1	16	MLEDNS174P5	17
MLDF643J5N	460	MLDL703J5N	184	MLEDNC102P5	16	MLEDNS175P1	17
MLDF643P5N	460	MLDL703J5N	204	MLEDNC103P1	16	MLEDNS175P5	17
MLDF842G2N	460	MLDP152G1N	186	MLEDNC103P5	16	MLEDNS254P5	17
MLDF842J5N	460	MLDP152G1N	206	MLEDNC152P5	16	MLEDNS255P5	17
MLDF842P5N	460	MLDP152J5N	186	MLEDNC153P5	16	MLEDNS354P5	17
MLDF843G2N	460	MLDP152J5N	206	MLEDNC172P1	16	MLEDNS355P5	17
MLDF843J5N	460	MLDP153G1N	186	MLEDNC172P5	16	MLEDNS404P5	17
MLDF843P5N	460	MLDP153G1N	206	MLEDNC173P1	16	MLEDNS405P5	17

Alphanumeric Index

Catalog Number	Page	Catalog Number	Page	Catalog Number	Page	Catalog Number	Page
MLEDNS704P5	17	MLLEDC22G5	34	MLLEDR35G5	35	MLRH104J5N	207
MLEDNS705P5	17	MLLEDC22J5	34	MLLEDR35J5	35	MLRH105G1N	187
MLEDNW102P1	16	MLLEDC22P5	34	MLLEDR35P5	35	MLRH105G1N	207
MLEDNW102P5	16	MLLEDC23D5	34	MLLEDR44D5	35	MLRH105J5N	187
MLEDNW103P1	16	MLLEDC23G5	34	MLLEDR44G5	35	MLRH105J5N	207
MLEDNW103P5	16	MLLEDC23J5	34	MLLEDR44J5	35	MLRH504G1N	187
MLEDNW152P5	16	MLLEDC23P5	34	MLLEDR44P5	35	MLRH504G1N	207
MLEDNW153P5	16	MLLEDC32D5	34	MLLEDR45D5	35	MLRH504J5N	187
MLEDNW172P1	16	MLLEDC32G5	34	MLLEDR45G5	35	MLRH504J5N	207
MLEDNW172P5	16	MLLEDC32J5	34	MLLEDR45J5	35	MLRH505G1N	187
MLEDNW173P1	16	MLLEDC32P5	34	MLLEDR45P5	35	MLRH505G1N	207
MLEDNW173P5	16	MLLEDC33D5	34	MLLEDS24D5	35	MLRH505J5N	187
MLEDNW252P5	16	MLLEDC33G5	34	MLLEDS24G5	35	MLRH505J5N	207
MLEDNW253P5	16	MLLEDC33J5	34	MLLEDS24J5	35	MLRH704G1N	187
MLEDNW352P5	15	MLLEDC33P5	34	MLLEDS24P5	35	MLRH704G1N	207
MLEDNW352P5	16	MLLEDC42D5	34	MLLEDS25D5	35	MLRH704J5N	187
MLEDNW353P5	16	MLLEDC42G5	34	MLLEDS25G5	35	MLRH704J5N	207
MLEDNW402P5	15	MLLEDC42J5	34	MLLEDS25J5	35	MLRH705G1N	187
MLEDNW402P5	16	MLLEDC42P5	34	MLLEDS25P5	35	MLRH705G1N	207
MLEDNW403P5	16	MLLEDC43D5	34	MLLEDS34D5	35	MLRH705J5N	187
MLEDNW702P5	16	MLLEDC43G5	34	MLLEDS34G5	35	MLRH705J5N	207
MLEDNW703P5	16	MLLEDC43J5	34	MLLEDS34J5	35	MLRL104G1N	185
MLED2A5W	37	MLLEDC43P5	34	MLLEDS34P5	35	MLRL104G1N	205
MLED2D5BU	36	MLLEDD22D5	34	MLLEDS35D5	35	MLRL104J5N	185
MLED2G5BU	36	MLLEDD22G5	34	MLLEDS35G5	35	MLRL104J5N	205
MLED2J5BU	36	MLLEDD22J5	34	MLLEDS35J5	35	MLRL105G1N	185
MLED2P5BU	36	MLLEDD22P5	34	MLLEDS35P5	35	MLRL105G1N	205
MLED3A5W	37	MLLEDD23D5	34	MLLEDS44D5	35	MLRL105J5N	185
MLED3D5BU	36	MLLEDD23G5	34	MLLEDS44G5	35	MLRL105J5N	205
MLED3G5BU	36	MLLEDD23J5	34	MLLEDS44J5	35	MLRL154G1N	185
MLED3J5BU	36	MLLEDD23P5	34	MLLEDS44P5	35	MLRL154G1N	205
MLED3P5BU	36	MLLEDD32D5	34	MLLEDS45D5	35	MLRL154J5N	185
MLED4A5W	37	MLLEDD32G5	34	MLLEDS45G5	35	MLRL154J5N	205
MLED4D5BU	36	MLLEDD32J5	34	MLLEDS45J5	35	MLRL155G1N	185
MLED4G5BU	36	MLLEDD32P5	34	MLLEDS45P5	35	MLRL155G1N	205
MLED4J5BU	36	MLLEDD33D5	34	MLLEDW22D5	35	MLRL155J5N	185
MLED4P5BU	36	MLLEDD33G5	34	MLLEDW22G5	35	MLRL155J5N	205
MLEDA22D5	34	MLLEDD33J5	34	MLLEDW22J5	35	MLRL504G1N	185
MLEDA22G5	34	MLLEDD33P5	34	MLLEDW22P5	35	MLRL504G1N	205
MLEDA22J5	34	MLLEDD42D5	34	MLLEDW23D5	35	MLRL504J5N	185
MLEDA22P5	34	MLLEDD42G5	34	MLLEDW23G5	35	MLRL504J5N	205
MLEDA23D5	34	MLLEDD42J5	34	MLLEDW23J5	35	MLRL505G1N	185
MLEDA23G5	34	MLLEDD42P5	34	MLLEDW23P5	35	MLRL505G1N	205
MLEDA23J5	34	MLLEDD43D5	34	MLLEDW32D5	35	MLRL505J5N	185
MLEDA23P5	34	MLLEDD43G5	34	MLLEDW32G5	35	MLRL505J5N	205
MLEDA32D5	34	MLLEDD43J5	34	MLLEDW32J5	35	MLRL704G1N	185
MLEDA32G5	34	MLLEDD43P5	34	MLLEDW32P5	35	MLRL704G1N	205
MLEDA32J5	34	MLLEDDBU	37	MLLEDW33D5	35	MLRL704J5N	185
MLEDA32P5	34	MLLEDDBU4	37	MLLEDW33G5	35	MLRL704J5N	205
MLEDA33D5	34	MLLEDR24D5	35	MLLEDW33J5	35	MLRL705G1N	185
MLEDA33G5	34	MLLEDR24G5	35	MLLEDW33P5	35	MLRL705G1N	205
MLEDA33J5	34	MLLEDR24J5	35	MLLEDW42D5	35	MLRL705J5N	185
MLEDA33P5	34	MLLEDR24P5	35	MLLEDW42G5	35	MLRL705J5N	205
MLEDA42D5	34	MLLEDR25D5	35	MLLEDW42J5	35	MLRP154G1N	187
MLEDA42G5	34	MLLEDR25G5	35	MLLEDW42P5	35	MLRP154G1N	207
MLEDA42J5	34	MLLEDR25J5	35	MLLEDW43D5	35	MLRP154J5N	187
MLEDA42P5	34	MLLEDR25P5	35	MLLEDW43G5	35	MLRP154J5N	207
MLEDA43D5	34	MLLEDR34D5	35	MLLEDW43J5	35	MLRP155G1N	187
MLEDA43G5	34	MLLEDR34G5	35	MLLEDW43P5	35	MLRP155G1N	207
MLEDA43J5	34	MLLEDR34J5	35	MLRH104G1N	187	MLRP155J5N	187
MLEDA43P5	34	MLLEDR34P5	35	MLRH104G1N	207	MLRP155J5N	207
MLLEDC22D5	34	MLLEDR35D5	35	MLRH104J5N	187	MLRP174G1N	187

Alphanumeric Index

Catalog Number	Page	Catalog Number	Page	Catalog Number	Page	Catalog Number	Page
MLRP174G1N	207	MLSL705G1N	205	MLWL502G1N	205	MS70125J-120	343
MLRP174J5N	187	MLSL705J5N	185	MLWL502J5N	185	MS70150-120	343
MLRP174J5N	207	MLSL705J5N	205	MLWL502J5N	205	MS70150J-120	343
MLRP175G1N	187	MLSPL154G1N	187	MLWL503G1N	185	MUL100-120	344
MLRP175G1N	207	MLSPL154G1N	207	MLWL503G1N	205	MUL150-120	344
MLRP175J5N	187	MLSPL154J5N	187	MLWL503J5N	185	MUL35-120	344
MLRP175J5N	207	MLSPL154J5N	207	MLWL503J5N	205	MUL50-120	344
MLRQ854G4N	170	MLSPL155G1N	187	MLWL702G1N	185	MUL70-120	344
MLRQ855G4N	170	MLSPL155G1N	207	MLWL702G1N	205	N2LED0T1	113
MLSH104G1N	187	MLSPL155J5N	187	MLWL702J5N	185	N2LED2T1	113
MLSH104G1N	207	MLSPL155J5N	207	MLWL702J5N	205	N2LEDBP	113
MLSH104J5N	187	MLSPL174G1N	187	MLWL703G1N	185	N2LEDCB	113
MLSH104J5N	207	MLSPL174G1N	207	MLWL703G1N	205	N2LEDLH	113
MLSH105G1N	187	MLSPL174J5N	187	MLWL703J5N	185	N2LEDR1R1	113
MLSH105G1N	207	MLSPL174J5N	207	MLWL703J5N	205	N2LEDR2R1	113
MLSH105J5N	187	MLSPL175G1N	187	MLWP152G1N	187	OBV1	345
MLSH105J5N	207	MLSPL175G1N	207	MLWP152G1N	207	OBV1-A	345
MLSH504G1N	187	MLSPL175J5N	187	MLWP152J5N	187	OBVW1	345
MLSH504G1N	207	MLSPL175J5N	207	MLWP152J5N	207	OBVW1-A	345
MLSH504J5N	187	MLSQ854G4N	170	MLWP153G1N	187	PAPL240-120	523
MLSH504J5N	207	MLSQ855G4N	170	MLWP153G1N	207	PAPL440-120	523
MLSH505G1N	187	MLWH102G1N	187	MLWP153J5N	187	PBAH25XJB	442
MLSH505G1N	207	MLWH102G1N	207	MLWP153J5N	207	PBAH40XJB	442
MLSH505J5N	187	MLWH102J5N	187	MLWP172G1N	187	PBAL15XJB	442
MLSH505J5N	207	MLWH102J5N	207	MLWP172G1N	207	PBAL25XJB	442
MLSH704G1N	187	MLWH103G1N	187	MLWP172J5N	187	PBAL40XJB	442
MLSH704G1N	207	MLWH103G1N	207	MLWP172J5N	207	PBAM25XJB	442
MLSH704J5N	187	MLWH103J5N	187	MLWP173G1N	187	PBAM40XJB	442
MLSH704J5N	207	MLWH103J5N	207	MLWP173G1N	207	PBAZ50B	442
MLSH705G1N	187	MLWH502G1N	187	MLWP173J5N	187	PBAZ70BTB	442
MLSH705G1N	207	MLWH502G1N	207	MLWP173J5N	207	PBGDG	442
MLSH705J5N	187	MLWH502J5N	187	MLWQ852G4N	170	PBHBG	442
MLSH705J5N	207	MLWH502J5N	207	MLWQ853G4N	170	PBPGZ	442
MLSL104G1N	185	MLWH503G1N	187	MOB10-120	344	PC120	128
MLSL104G1N	205	MLWH503G1N	207	MOB10J-120	344	PC120	679
MLSL104J5N	185	MLWH503J5N	187	MOB15-120	344	PC120D2	23
MLSL104J5N	205	MLWH503J5N	207	MOB15J-120	344	PC120D2	41
MLSL105G1N	185	MLWH702G1N	187	MOB35-120	344	PC120D2	175
MLSL105G1N	205	MLWH702G1N	207	MOB35J-120	344	PC120D2	193
MLSL105J5N	185	MLWH702J5N	187	MOB50-120	344	PC120D2	213
MLSL105J5N	205	MLWH702J5N	207	MOB50J-120	344	PC120D2	242
MLSL154G1N	185	MLWH703G1N	187	MOB70-120	344	PC120D2	277
MLSL154G1N	205	MLWH703G1N	207	MOB70J-120	344	PC120D2	301
MLSL154J5N	185	MLWH703J5N	187	MS10125-120	343	PC120D2	321
MLSL154J5N	205	MLWH703J5N	207	MS10125J-120	343	PC120D2	333
MLSL155G1N	185	MLWL102G1N	185	MS10150-120	343	PC120D2	678
MLSL155G1N	205	MLWL102G1N	205	MS10150J-120	343	PC247D2	23
MLSL155J5N	185	MLWL102J5N	185	MS-125	345	PC247D2	41
MLSL155J5N	205	MLWL102J5N	205	MS-150	345	PC247D2	175
MLSL504G1N	185	MLWL103G1N	185	MS15125-120	343	PC247D2	193
MLSL504G1N	205	MLWL103G1N	205	MS15125J-120	343	PC247D2	213
MLSL504J5N	185	MLWL103J5N	185	MS15150-120	343	PC247D2	242
MLSL504J5N	205	MLWL103J5N	205	MS15150J-120	343	PC247D2	277
MLSL505G1N	185	MLWL152G1N	185	MS35125-120	343	PC247D2	301
MLSL505G1N	205	MLWL152G1N	205	MS35125J-120	343	PC247D2	321
MLSL505J5N	185	MLWL152J5N	185	MS35150-120	343	PC247D2	333
MLSL505J5N	205	MLWL152J5N	205	MS35150J-120	343	PC247D2	678
MLSL704G1N	185	MLWL153G1N	185	MS50125-120	343	PC248	128
MLSL704G1N	205	MLWL153G1N	205	MS50125J-120	343	PC248	679
MLSL704J5N	185	MLWL153J5N	185	MS50150-120	343	PCAH25XJB	433
MLSL704J5N	205	MLWL153J5N	205	MS50150J-120	343	PCAH40XJB	433
MLSL705G1N	185	MLWL502G1N	185	MS70125-120	343	PCAL15XJB	433

Alphanumeric Index

Catalog Number	Page	Catalog Number	Page	Catalog Number	Page	Catalog Number	Page
PCAL25XJB	433	REA-1BR	614	SBDSRC4004A	586	VA2125G-M	606
PCAL40XJB	433	REA-50	614	SBDSRC4004D	586	VA50	345
PCAL60XJB	433	REA-75	614	SBDSRC4011A	586	VA50	607
PCAM25XJB	433	REB218BUFL	538	SBDSRC4024A	586	VA75	345
PCAM40XJB	433	REB218BUFLEP	538	SBDSSC	586	VA75	607
PCAZ50B	433	REB218BUFT	538	SLC1075	682	VAD-1M	608
PCGDG	434	REB218BUFTFP	538	SLC75	682	VAD-2M	608
PCHBG	434	REB236BUFL	538	SPBB-U1-Q	512	VC50	607
PCHBG	438	REB236BUFLE	538	SPF-1001	389	VC75	607
PCHC49G	434	REB236BUFT	538	SPF-1004	389	VCA1075	597
PCHC60G	434	REB236BUFTE	538	SPLNS-RE-B	512	VCA1075G	597
PCPGZ	434	REB258BUFL	538	TGH12C	675	VCA2075	597
PCSBG	434	REB258BUFLE	538	TGH12H	675	VCA2075G	597
PCVG	434	REB258BUFT	538	TGH13C	675	VCA75	599
PJ5501B	671	REB258BUFTE	538	TCH22M	675	VCAN10125	597
PJ7002B	671	REB418BUFLEP	538	TCHL25C	675	VCAN10125G	597
PJ7011A	671	REB418BUFLP	538	TCHL28H	675	VCAN125	599
PJ7023A	671	REB418BUFTFP	538	TCHL37C	675	VCAN20125	597
PLAL25XJB	438	REB418BUFTP	538	TL40PMT0	717	VCAN20125G	597
PLAL40XAB	438	REB436BUFLEP	538	TLGUARDW	717	VCB75	599
PLAZ50B	438	REB436BUFLP	538	TLTRAPW	717	VCFGU-1	600
PLT26	502	REB436BUFTFP	538	TVA1400	574	VCFGU-2	600
PLT32	502	REB436BUFTP	538	TVA1490	574	VCGU-GK	600
PLT32RS	491	REB458BUFLEP	538	TVA1490	576	VCJB50	599
PLT32RS	502	REB458BUFLP	538	TVA1490C	574	VCJB75	599
PLT42	502	REB458BUFTFP	538	TVA1490CH	574	VCLR-1	600
PND1	423	REB458BUFTP	538	TVA1490H	574	VC0B1	599
PNG1	423	RECMSS	539	TVA1490Y	574	VC0B10	597
PNHB1	423	RECMST	539	TVA1490YH	574	VC0B10G	597
PNHC49G	438	REEBSS	539	TVA2400	574	VC0B20	597
PNHC49G	442	REEBST	539	TVA2490	574	VC0B20G	597
PNHC60G	438	REFBSS	539	TVA2490	576	VC0BW1	599
PNHC60G	442	REFBST	539	TVA2490C	574	VC0BW10	598
PNL1H40AGXJ	429	S865	581	TVA2490CH	574	VC0BW10G	598
PNL1H40APXJ	429	S865	572	TVA2490H	574	VC0BW20	598
PNL1L40AGXJ	429	SBDBFR0502A	589	TVA2490Y	574	VC0BW20G	598
PNL1L40APXJ	429	SBDBFR0502D	589	TVA2490YH	574	VCW1075	598
PNM1H15AGXJ	429	SBDBFR0504A	589	TVA-FL	575	VCW1075G	598
PNM1H15APXJ	429	SBDBFR0504D	589	UNJ-50	694	VCW2075	598
PNM1H25AGXJ	429	SBDBFR0511A	589	UNJ-75	694	VCW2075G	598
PNM1H25APXJ	429	SBDBFR0511D	589	V-1025	574	VCWB1075	598
PNM1H40AGXJ	429	SBDBFR0523A	589	V-1433	748	VCWB1075G	598
PNM1L15AGXJ	429	SBDBRC4004A	589	V-1434	748	VCWB2075	598
PNM1L15APXJ	429	SBDBRC4004D	589	V-2010	574	VCWB2075G	598
PNM1L25AGXJ	429	SBDBRC4011A	589	V-2055G	574	VCX1075	597
PNM1L25APXJ	429	SBDBRC4024A	589	V-2100BULK	748	VCX1075G	597
PNM1L40AGXJ	429	SDBBSC	589	V-2200BULK	748	VCX2075	597
PNM1L70AGXJ	429	SBD CFR1502D	592	V50	607	VCX2075G	597
PNM1L70APXJ	429	SBD CFR1504D	592	V75	607	VCX50	599
PNM1M25AGXJ	429	SBD CFR1511A	592	V-990C	574	VCX75	599
PNM1M25APXJ	429	SBD CFR1523A	592	V-990R	574	VD50	607
PNM1M40AGXJ	429	SBD CS0723A	592	V-990Y	574	VD75	607
PNPB115	423	SBDGA	586	VA100	345	VGA50	607
PNPB120	423	SBDGA	589	VA100	607	VGA75	607
PNSBG	438	SBDGC	586	VA1050G-M	606	VGAT50	607
PNSBG	442	SBDGC	589	VA1075G-M	606	VGAT75	607
PNTB1	423	SBDGG	586	VA1100G-M	606	VGL-1AM	609
PWK	389	SBDGG	589	VA1125G-M	606	VGL-1AM	614
REA-1050	614	SBDGR	586	VA125	607	VGL-1BL	609
REA-1075	614	SBDGR	589	VA2050G-M	606	VGL-1BL	614
REA-10B	614	SBD0SG	584	VA2075G-M	606	VGL-1CL	609
REA-10LB	614	SBD0SR	584	VA2100G-M	606	VGL-1CL	614

Alphanumeric Index

Catalog Number	Page	Catalog Number	Page	Catalog Number	Page	Catalog Number	Page
VGL-1GR	609	VPGL-2AM	332	VPGU-1	600	VRW-1ST	610
VGL-1GR	614	VPGL-2AM	600	VPGU-2	600	VRW-2AN	610
VGL-1HR	609	VPGL-2AMPL	236	VPJB50	599	VRW-2ST	610
VGL-1HR	614	VPGL-2AMPL	271	VPJB75	599	VSL-2HR	634
VGL-1OP	609	VPGL-2AMPL	332	VPLR-123	600	VT50	607
VGL-1OP	614	VPGL-2AMPL	600	VPLR-123	614	VT75	607
VGL-1RE	609	VPGL-2BL	236	VPLR-123	634	VU100M	608
VGL-1RE	614	VPGL-2BL	271	VPOB1	599	VU100MLG	608
VGL-2AM	609	VPGL-2BL	332	VPOB10	597	VU200M	608
VGL-2BL	609	VPGL-2BL	600	VPOB10G	597	VU200MLG	608
VGL-2CL	609	VPGL-2BLPL	600	VPOB20	597	VWG-1	609
VGL-2GR	609	VPGL-2GR	236	VPOB20G	597	VWG-1	614
VGL-2HR	609	VPGL-2GR	271	VPOBW1	599	VWG-2	609
VGL-2OP	609	VPGL-2GR	332	VPOBW10	598	VX50	607
VGL-2RE	609	VPGL-2GR	600	VPOBW10G	598	VX75	607
VGU-1	614	VPGL-2GRPL	236	VPOBW20	598	VXHA100	345
VMA100	345	VPGL-2GRPL	271	VPOBW20G	598	VXHA100	607
VMA75	345	VPGL-2GRPL	332	VPT-1AV	610	VXHA100-A	345
VPA1075	597	VPGL-2GRPL	600	VPT-2	610	VXHA1050G-M	606
VPA1075G	597	VPGL-2HR	236	VPT-3	610	VXHA1075G-M	606
VPA2075	597	VPGL-2HR	271	VPT-4	610	VXHA1100G-M	606
VPA2075G	597	VPGL-2HR	332	VPT-7	355	VXHA2050G-M	606
VPA75	599	VPGL-2HR	600	VPT-7	369	VXHA2075G-M	606
VPAN10125	597	VPGL-2HRT	236	VPT-7	491	VXHA2100G-M	606
VPAN10125G	597	VPGL-2HRT	271	VPT-7	502	VXHA50	345
VPAN125	599	VPGL-2HRT	332	VPT-7	581	VXHA50	607
VPAN20125	597	VPGL-2HRT	600	VPT-7	610	VXHA50-A	345
VPAN20125G	597	VPGL-2PL	236	VPT-7	618	VXHA75	345
VPAS75120ACCL	571	VPGL-2PL	271	VPT-7	626	VXHA75	607
VPAS751248DCCL	571	VPGL-2PL	332	VPT-7	631	VXHA75-A	345
VPAS75240ACCL	571	VPGL-2PL	346	VPT-7P	581	XP163SA	669
VPAS7524PDCCL	571	VPGL-2PL	600	VPT-8	610	XP419	669
VPAS75250DCCL	571	VPGL-2RE	236	VPWB1050	598		
VPG-1AM	609	VPGL-2RE	271	VPWB1050G	598		
VPG-1AM	614	VPGL-2RE	332	VPWB1075	598		
VPG-1BL	609	VPGL-2RE	600	VPWB1075G	598		
VPG-1BL	614	VPGL-2REPL	236	VPWB2050	598		
VPG-1CL	609	VPGL-2REPL	271	VPWB2050G	598		
VPG-1CL	614	VPGL-2REPL	332	VPWB2075	598		
VPG-1GR	609	VPGL-2REPL	600	VPWB2075G	598		
VPG-1GR	614	VPGL3HR	236	VPWB50	599		
VPG-1RE	609	VPGL3HR	271	VPWB75	599		
VPG-1RE	614	VPGL-4HR	172	VPWBS75120ACCL	571		
VPGL-1AM	190	VPGL-4HR	298	VPWBS751248DCCL	571		
VPGL-1AM	210	VPGL-4HR	318	VPWBS75240ACCL	571		
VPGL-1AM	600	VPGL-DIFF	21	VPWBS7524DCCL	571		
VPGL-1BL	190	VPGL-DIFF	37	VPWBS75250DCCL	571		
VPGL-1BL	210	VPGL-DIFF	124	VPX1050	597		
VPGL-1BL	600	VPGL-GK	190	VPX1050G	597		
VPGL-1GR	190	VPGL-GK	210	VPX1075	597		
VPGL-1GR	210	VPGL-GK	238	VPX1075G	597		
VPGL-1GR	600	VPGL-GK	273	VPX2050	597		
VPGL-1HR	190	VPGL-GK	333	VPX2050G	597		
VPGL-1HR	210	VPGL-GK	346	VPX2075	597		
VPGL-1HR	346	VPGL-GK	600	VPX2075G	597		
VPGL-1HR	572	VPGL-GLASS	37	VPX50	599		
VPGL-1HR	600	VPGL-GLASS	124	VPXS75120ACCL	571		
VPGL-1RE	190	VPGL-LED	21	VPXS751248DCCL	571		
VPGL-1RE	210	VPGL-LED	37	VPXS75240ACCL	571		
VPGL-1RE	600	VPGL-LED	124	VPXS7524PDCCL	571		
VPGL-2AM	236	VPGL-LED	124	VPXS75250DCCL	571		
VPGL-2AM	271	VPGU-1	346	VRW-1AN	610		
		VPGU-1	571				

Lighting

Description	Page	NEC	CEC	ATEX/IEC(Ex)
LED/Area: NEC/CEC, ATEX/IECEX Enclosed and Gasketed				
Mercmaster™ LED Series Luminaires	8	X	X	
Mercmaster™ LED Low Profile Series Luminaires	29	X	X	
NEC/CEC Viamaster™ LED Series Luminaires	48	X	X	
ATEX/IECEX Viamaster™ LED Series Luminaires	60			X
LED/Area: NEC/CEC Explosionproof/ATEX/IECEX Flameproof				
Code•Master™ LED Factory Sealed Luminaires	72	X	X	
ATX™ FDLED Series Luminaires	87			X
ATX™ DEMULED Series Luminaires	90			X
LED/Area: NEC/CEC Emergency				
Viamaster™ LED Series Emergency Battery Backup Luminaires	93	X	X	
N2LED Series Emergency Luminaires	110	X	X	
LED/Area: NEC/CEC Ordinary Location				
Industrial Mercmaster™ LED Low Profile Series Luminaires	117	X	X	
LED/Floodlights: NEC/CEC, ATEX/IECEX Enclosed and Gasketed				
Areamaster™ LED Flood/High Bay Floodlights	135	X	X	X
LED/Floodlights: NEC/CEC Ordinary Location				
Industrial Areamaster™ LED Flood/High Bay Luminaires	145	X	X	
Areamaster™ Green LED Flood and High Bay Luminaires	152	X	X	
LED/ATEX/IECEX Bulkhead				
ATX™ FDBAES LED Series Self-Contained Emergency	156			X
ATX™ FNES LED Series Self-Contained Emergency Lighting with Self-Test System	161			X
Induction/Area: NEC/CEC Enclosed and Gasketed				
Mercmaster™ III Induction Luminaires	165	X	X	



Mercmaster™ LED



Mercmaster™ LED Low Profile



Viamaster™ LED



Code•Master™ LED



FDLED



DEMULED



N2LED



Areamaster™ LED



FDBAES



FNES



Mercmaster™ III Induction

Lighting

Description	Page	NEC	CEC	ATEX/ IEC(Ex)
HID/Area: NEC/CEC Enclosed and Gasketed				
Mercmaster™ III Low Profile Luminaires	178	X	X	
Mercmaster™ III Low Profile Luminaires	198		X	
Mercmaster™ III HID 50—250 Watt Luminaires	218	X	X	
Mercmaster™ III HID 50—250 Watt Luminaires	251		X	
Mercmaster™ III 400 Luminaire for Hazardous and Wet Locations	287	X	X	
Mercmaster™ III 400 Luminaire for Hazardous and Wet Locations	305		X	
Mercmaster™ II HID Luminaires	325	X		
Mercmaster™ Jr. Luminaires	341	X		
HID/Area: NEC/CEC Explosionproof				
Code•Master™ 2 HID Factory Sealed Luminaires	348	X	X	
Code•Master™ Jr. HID Factory Sealed Luminaires	363	X	X	
HID/Area: ATEX/IECEx Restricted Breathing Dust				
Mercmaster™ ATEX LN Series Wellglass Luminaires	374			X
HID/Area: NEC/CEC Ordinary Location High Bay				
Baymaster™ Prismatic 250/400 High Bay Luminaires	384	X	X	
Super–Baymaster™ High Bay Luminaires	388		X	
HID/Area: NEC/CEC Industrial Architectural				
Wallmaster™ HPS/PSMH Luminaires	391	X	X	
HID/Floodlight: NEC/CEC Enclosed and Gasketed				
Areamaster™ 250/400 Integrally Ballasted Floodlights	395	X	X	
Areamaster™ 1000 Floodlights	403	X	X	
Areamaster™ Stainless Steel Floodlights	408	X	X	



Mercmaster™ III



Mercmaster™ III 50–250



Mercmaster™ III 400



Mercmaster™ II HID



Mercmaster™ Jr.



Code•Master™



Code•Master™ Jr



Mercmaster™ ATEX LN



Baymaster™ 250/400



Super–Baymaster™



Wallmaster™



Areamaster™ 250/400



Areamaster™ 1000



Areamaster™ SS

Lighting

Description	Page	NEC	CEC	ATEX/ IEC(Ex)
HID/Floodlight: NEC/CEC Hazardous Architectural				
Wallmaster™ I/2 for Hazardous and Wet Locations — Class I, Division 2/Zone 2	412	X	X	
HID/Floodlight: NEC/CEC Explosionproof				
Code•Master™ 2 HID Factory Sealed Floodlights	414	X	X	
EFL Series HID and Quartz Floodlights	422	X	X	
HID/Floodlight: ATEX/IECEx Flameproof				
Areamaster™ ATEX PN Series Floodlights	426			X
ATX™ PC Series Floodlights	431			X
ATX™ PL Series Floodlights	436			X
HID/Floodlight: NEC/CEC, ATEX/IECEx Flameproof				
ATX™ PB Series Floodlights	440	X	X	X
HID/Floodlight: NEC/CEC Ordinary Location				
Areamaster™ 250/400 Integrally Ballasted Floodlights	444	X		
Areamaster™ 1000 Floodlights	448	X		
Beam–Master™ Floodlights	452	X	X	
Fluorescent/Area: NEC/CEC Enclosed and Gasketed				
Mercmaster™ III Low Profile Compact Fluorescent Luminaires	455	X	X	
FV Series Nonmetallic Fluorescent Luminaires	469	X	X	
FR Enclosed and Gasketed; FZ and FD Hazardous Locations Luminaires	474	X	X	
RigMaster™ Metallic Fluorescent Luminaires	480	X		
RigMaster™ 304 Stainless Steel Fluorescent Luminaires	485		X	
Fluorescent/Area: NEC/CEC Explosionproof				
Code•Master™ 2 Emergency PLT Factory Sealed Luminaires	487	X		
Code•Master™ PLT Factory Sealed Luminaires	496	X	X	
ELS Series Emergency Lighting System	508	X		
APL Two and Four Lamp Fluorescent Factory Sealed Luminaires	514	X	X	
EFU Fluorescent Factory Sealed Luminaires	518	X	X	
PAPL Portable Two and Four Lamp Fluorescent Factory Sealed Luminaire	522	X	X	

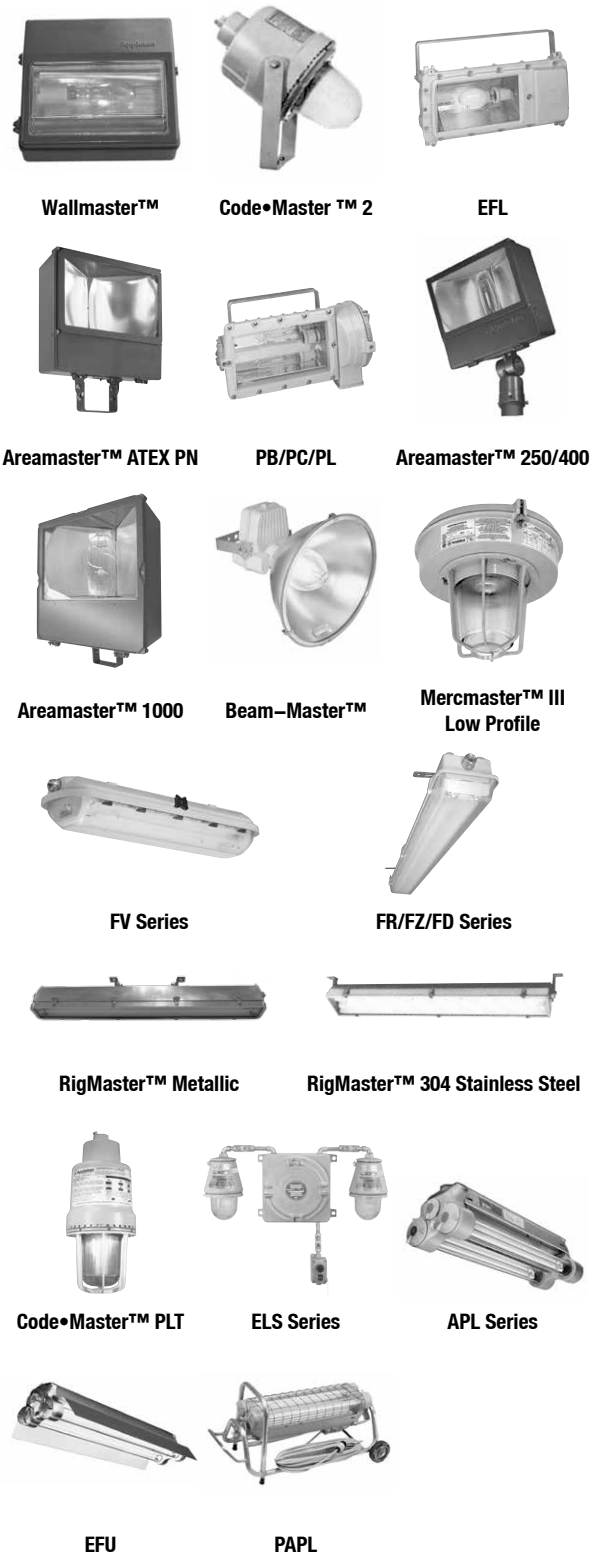

Lighting

Description	Page	NEC	CEC	ATEX/IEC(Ex)
Fluorescent/Area: ATEX/IECEx Standard and Emergency Back-Up				
ATX™ FL Series Light Duty Nonmetallic Fluorescent Luminaires	524			X
ATX™ FN Series Heavy Duty Nonmetallic Fluorescent Luminaires	529			X
ATX™ RE Series Recessed and Surface Mounting Fluorescent Luminaires	535			X
ATX™ FD Series Cylindrical Fluorescent Luminaires	544			X
ATX™ FE Series Nonmetallic Fluorescent Luminaires	551			X
Fluorescent/Emergency: ATEX/IECEx Increased Safety				
ATX™ FDES Series Self-Contained Emergency	565			X
Visual Signal: NEC/CEC Enclosed and Gasketed				
Stylmaster™ Strobe Luminaires	569	X	X	
TVA Obstruction, Approach and Boundary Luminaires	573		X	
Visual Signal: NEC/CEC Explosionproof				
Code•Master™ Factory Sealed Strobe Luminaires	577	X		
Visual Signal: ATEX/IECEx Flameproof				
ATX™ SBDO Series Signaling and Lighting Bulkheads	583			X
ATX™ SBDS Series Beacon Lighting Units	585			X
ATX™ SBDB Series Beacon and Strobe Lighting Units	587			X
ATX™ SBDC Series Strobe Lighting and Static Triple Indicator	591			X
Labels for ATEX/IECEx Emergency Lighting Units				
ATX™ Self-Adhesive Signaling Labels for Emergency Lighting Units	594			X
Incandescent/Area: NEC/CEC Enclosed and Gasketed				
Stylmaster™ Incandescent Luminaires	595	X	X	
V—51™ Incandescent Luminaires	604	X	X	
REA 150 W Incandescent Luminaires	613	X		
Incandescent/Area: NEC/CEC Enclosed and Gasketed				
Code•Master™ Incandescent Factory Sealed Luminaires	615	X		
A—51™ Incandescent Factory Sealed Luminaires	620	X	X	
EDT Incandescent Luminaires	634	X	X	



FL Series FN Series RE



FD FE FDES



Stylmaster™ Strobe TVA Code•Master™ Strobe



SBDO SBDS SBDB



SBDC Labels Stylmaster™



V—51™ REA Code•Master™



A—51™ EDT

Lighting

Description	Page	NEC	CEC	ATEX/IEC(Ex)
Incandescent/Area: ATEX Increased Safety				
ATX™ HBE Series Round Bulkhead Luminaires	635			X
Incandescent/Area: ATEX Emergency				
ATX™ ELS Series Self-Contained Emergency Lighting Unit	638			X
Incandescent/Area: ATEX/IECEx Flameproof				
ATX™ HBD Series Bulkhead Luminaires	640			X
ATX™ HBN Series Round Bulkhead Luminaires	644			X
ATX™ HBDC Series Cylindrical Bulkhead Luminaires	646			X
ATX™ LDP Series Wellglass Luminaires	650			X
ATX™ LDM Series Wellglass Luminaires	652			X
ATX™ LDB, LDB, LDG, LRD Series Wellglass Luminaires	656			X
ATX™ HBDA Series Rectangular Bulkhead Luminaires	661			X
ATX™ HRD Series Tank Inspection Lights	663			X
Incandescent/FloodLight: NEC/CEC Explosionproof				
EF Series Explosionproof Floodlights	666	X		
Incandescent/Portable: NEC/CEC Explosionproof				
AHL and EHL Incandescent Factory Sealed Luminaires and Handlamps	668	X	X	
Incandescent/Halogen/Portable: ATEX Flameproof				
ATX™ PJ Series Portable Floodlights	670			X
ATX™ HLD Series Handlamps	672			X
Incandescent/Halogen/Portable: ATEX Increased Safety				
TCH Series Safety Flashlights	674			X
PhotoControls/NEC/CEC Enclosed and Gasketed				
EFKB Series Photocontrol	677	X		
PCD2 Series Hazardous Location Photocontrol	678	X	X	
PC Series Industrial Location Photocontrol	679	X	X	



HBE/HBN



ELS



HBD



HBDC



LDP



LDM



LDB/LDB/LDG/LRD



HBDA



HRD



EF



AHL/EHL



PJ



HLD



TCH

Description	Page	NEC	CEC	ATEX/ IEC(Ex)
Poles/Hangers: NEC/CEC Explosionproof Flexible Fixture Hangers				
BKX Rigid Fixture Hangers	680		X	
CPU and EFHU Fixture Hangers	684	X	X	
Flexible Fixture Hangers, EXJF Couplings, ESD and ESS Swivels	687	X	X	
EFHC and EFHCA Fixture Hangers and Accessories	690	X	X	
GRF Conduit Outlet Boxes, Fixture Hanger Covers and Canopies	692	X	X	
Poles/Hangers: NEC/CEC Ordinary Location Flexible Fixture Hangers				
AHG and UNJ Flexible Fixture Hangers	694	X	X	
AL Ball and Cushion Flexible Fixture Hangers	695	X		
JB and GS Flexible Fixture Hangers	699	X	X	
SSH Flexible Fixture Hangers	701	X	X	
SHC Flexible Fixture Hangers	703	X	X	
EF and FHS Series Flexible Hangers	704		X	
FH and FHSN Series Flexible Fixture Hangers	705		X	
GHBPH Power Hook for Industrial High Bay Luminaires	707	X	X	
Power Hook for Industrial High Bay Luminaires	708		X	
Poles/Hangers: NEC/CEC Ordinary Location Architectural				
Round Tapered Steel Poles	709	X	X	
Hinged Steel Poles	710	X	X	
Square Tapered Steel Poles	711	X	X	
Square Steel Poles	712	X	X	
Floodlight Mounting Brackets	713	X	X	



BKX



CPU



ESD



EFHC



GRF



Bracket



UNJ



AL



JB



SSH



SHC



Hook and Loop



Receptacle and Hook and Loop



Power Hook



Mounting Poles

Lighting

Description	Page	NEC	CEC	ATEX/ IEC(Ex)
General Temporary Lighting				
McGill™ HID Temporary Lighting	717	X		
McGill™ String–0–Lights	718	X	X	
McGill™ 7000 Series Industrial Extension Lights	720	X	X	
McGill™ 7000–38 Series Industrial Extension Lights	723		X	
McGill™ 6000 Series Commercial–Duty Extension Lights	724	X	X	
McGill™ 5000 Series Industrial Extension Lights	725	X	X	
McGill™ Handy Compact Fluorescent Work Light	726	X		
McGill™ Rough Service Fluorescent Lamp	727	X		
McGill™ Fluorescent Work Lights	728	X	X	
McGill™ Battery Pack with Charger	729	X	X	
McGill™ Fluorescent Industrial Extension Lights	730	X	X	
McGill™ High Intensity Low–Voltage Extension Lights	731	X	X	
McGill™ Mini–Powerpak Low–Voltage Extension Lights	732	X		
McGill™ Fluorescent Hand Lamps — Explosionproof	733	X		
McGill™ Tubular Fluorescent Inspection Light — Explosionproof	734	X		
McGill™ Industrial Extension Lights — Explosionproof	735	X		
McGill™ Low–Voltage, High Intensity Hand Lamp — Explosionproof	736	X		
General Utility Lights				
McGill™ Fluorescent Utility Lights	737	X	X	
McGill™ Incandescent Utility Lights	738	X	X	
Lamp Changers				
McGill™ Fluorescent Lamp Changers	740	X	X	
McGill™ Incandescent Lamp Changers	741	X	X	
McGill™ Lamp Changer Accessories and Replacement Parts	743	X	X	
Lamp Protection				
McGill™ Protect–0–Sleeves	744	X		
McGill™ Tubeloc Holders	746	X	X	
McGill™ Protect–0–Globes	747	X		
McGill™ Wire Lamp Guards and Wire Lamp Guard Grounding Kit	748	X		



HID Temp



String–0–Lights



Extension Lights



Work Lights



Battery Pack



Extension Lights



Explosionproof Lights



Utility Lights



Lamp Changers



Lamp Changers



Protect–0–Sleeves



Tubeloc Holders

Mercmaster™ LED Series Luminaires

Enclosed and Gasketed Fixtures

NEC/CEC:
Class I, Division 2, Groups A, B, C, D
Class I, Zone 2, AEx nA IIC
Class II, Division 1, Group E, F, G
Class II, Division 2, Group F, G
Class III

NEC/CEC:
Type 3R, 4, 4X
IP66/67
Simultaneous Exposure
Suitable for Use in Wet Locations
Marine Outside Type (Salt Water)

ATEX/IECEX:
Zone 2 and 22
II 2 GD
IP66/67

Applications

- Enclosed and gasketed fixtures suitable for use in:
 - Marine and wet locations
 - A wide range of industrial, chemical processing and other areas where flammable gases and vapors are present
 - Areas of low clearance or low ceiling heights
 - Non-hazardous locations where severe weather conditions, excessive moisture, dirt, dust, corrosive atmosphere or high ambient temperatures are encountered
- Typical applications include:
 - Pulp and paper mills
 - Processing plants
 - Chemical plants
 - Oil refineries
 - Foundries
 - Manufacturing plants
 - Storage areas
 - Waste and sewage treatment
 - Parking garages
 - Other areas where dust, water, dirt and rough usage are a problem



Features

- Compact light weight low profile design is suited for low mounting heights.
- Modular design allows scores of fixture component combinations to meet installation needs. Uses same mounting hoods as Mercmaster III.
- Fixture housing and mounting hoods are copperfree cast aluminum with baked epoxy finish. All exposed hardware is stainless steel.
- Accommodates a wide range of voltages.
- Ambient temperatures:
 - 70 W to 100 W equivalent: -40 °C to +65 °C (-40 °F to +149 °F)
 - 150 W to 175 W equivalent: -40 °C to +55 °C (-40 °F to +131 °F)
 - 250 W equivalent: -40 °C to +50 °C (-40 °F to +122 °F)
 - 350 W equivalent: -40 °C to +50 °C (-40 °F to +122 °F)
 - 400 W equivalent: -40 °C to +55 °C (-40 °F to +131 °F)
- Electrical: 120-277 Vac, 50/60 Hz; 347-480 Vac, 50/60 Hz, Volts +/- 10%.
- Pole terminal block: 1 x 8-24 AWG; 1 x 0.75 to 6 mm² (0.0012 to 0.0093 in²).
- Hinge has high lip for added safety during installation and servicing. Hinge and bolt construction assures 360° compression at all points on ballast housing gasket for positive sealing. Swing away design of captive bolt and nut simplifies servicing.
- All Mercmaster mounting hoods have provision for easy field installation of fuses in fixtures (see Fixture Unit — Electrical Specification).
- NPT and metric threads standard.
- NEMA Type V light distribution is standard.
 - Type V distribution is required in areas where sufficient, evenly distributed light is necessary. It produces a circular distribution that has the same intensity at all angles.

- NEMA Type I light distribution is available as an option for select NEC/CEC certified fixtures.
 - Type I distribution is the perfect lighting for walkways, Type I distribution is perfect for lighting walkways, catwalks or anyplace where a narrow beam of light is required.
- For ATEX/IECEX rated fixtures, ballast bodies and mounting hoods must be purchased separately.

Standard Materials

- Mounting hoods and bodies: cast copperfree (4/10 of 1% max.) aluminum
- All hardware and catch assemblies: stainless steel
- Globe: polycarbonate

Standard Finishes

- Mounting hoods, bodies and guards: baked gray epoxy-clad finish, electrostatically applied for complete uniform protection

NEC/CEC Certifications and Compliances

- UL Standard: UL 50; UL 844; UL 1598; UL 1598A; UL 8750
- CSA Standard: C22.2 No 0; C22.2 No. 0.4; C22.2 No. 0.5; C22.2 No. 94; C22.2 No. 60529; C22.2 No. 137; C22.2 No. 250.0; C22.2 No. 60079; E60079-15
- ANSI/UL Standards: 60079-0; 60079-15
- ANSI/IEC Standards: 60529
- cCSAus Certified: 65182

Mercmaster™ LED Series Luminaires

Enclosed and Gasketed Fixtures

NEC/CEC:

Class I, Division 2, Groups A, B, C, D
Class I, Zone 2, AEx nA IIC
Class II, Division 1, Group E, F, G
Class II, Division 2, Group F, G
Class III

NEC/CEC:

Type 3R, 4, 4X
IP66/67
Simultaneous Exposure
Suitable for Use in Wet Locations
Marine Outside Type (Salt Water)

ATEX/IECEx:

Zone 2 and 22
II 2 GD
IP66/67

ATEX/IECEx Certification and Compliances

- ATEX
 - Gas: Zone 2
 - Conforming to ATEX 94/9/CE: Ⓜ II 3 G
 - Type of Protection: Ex nA IIC Gc
 - Temperature class:
 - 70 W and 100 W equivalent: T4 [+40 °C (+104 °F)], T4 [+55 °C (+131 °F)], T3 [+65 °C (+149 °F)]
 - 150 W to 175 W equivalent: T4 [+40 °C (+104 °F)], T4 [+55 °C (+131 °F)]
 - 250 W equivalent: T4 [+40 °C (+104 °F)], T4 [+50 °C (+122 °F)]
 - Dust: Zone 22
 - Conforming to ATEX 94/9/CE: Ⓜ II 3 D
 - Type of Protection: Ex tc IIIc Dc
 - Surface Temperature:
 - 70 W and 175 W equivalent: T92 °C (T197.6 °F)
 - 250 W equivalent: T79 °C (T174.2 °F)
 - Ambient Temperature:
 - 70 W and 100 W equivalent: -40 °C to +65 °C (-40 °F to +149 °F)
 - 150 W to 175 W equivalent: -40 °C to +55 °C (-40 °F to +131 °F)
 - 250 W equivalent: -40 °C to +50 °C (-40 °F to 122 °F)
 - ATEX Certificate: LCIE 11 ATEX 1008, LCIE 14 ATEX 3063
 - IECEx Certificate: IECEx LCI 11.0058
 - Index of Protection according EN/IEC 60529: IP66
- IECEx
 - Gas: Zone 2
 - Type of Protection: Ex nA IIC Gc
 - Temperature class:
 - 70 W to 175 W equivalent: T4 [+40 °C (+104 °F)], T4 [+55 °C (+131 °F)]
 - 250 W equivalent: T4 [+40 °C (+104 °F)], T4 [+50 °C (+122 °F)]
 - Dust: Zone 22
 - Type of Protection: Ex tc IIIc Dc
 - Surface Temperature:
 - 70 W and 175 W equivalent: T92 °C (198 °F)
 - 250 W equivalent: T79 °C (198 °F)
 - Ambient Temperature:
 - 70 W and 175 W equivalent: -40 °C to +55 °C (-40 °F to +131 °F)
 - 250 W equivalent: -40 °C to +50 °C (-40 °F to +122 °F)
 - IECEx Certificate: IECEx LCI 11.0058
 - Index of Protection according EN/IEC 60529: IP66

EURASEC Certification

- EURASEC N° TC RU C-FR.Г505.B.00912

Other Certification

- INMETRO Certificate: BVC12.1522 ①

NEC/CEC Related Products

- NEC, Class I, Division 2 photocells for classified use are available, see *PCD2 Series*.
- Mounting hoods with photocontrols are not rated IP66/67, Type 4X or Marine Outside Type (Salt Water).

DesignLights™ Consortium (for the following models)

- MLEDN15
- MLEDN17
- MLEDN25
- MLEDN35
- MLEDN40

① Inmetro certification available on special request only. Contact your local sales representative for more information.

Mercmaster™ LED Series Luminaires

Enclosed and Gasketed Fixtures

NEC/CEC:

Class I, Division 2, Groups A, B, C, D
 Class I, Zone 2, AEx nA IIC
 Class II, Division 1, Group E, F, G
 Class II, Division 2, Group F, G
 Class III

NEC/CEC:

Type 3R, 4, 4X
 IP66/67
 Simultaneous Exposure
 Suitable for Use in Wet Locations
 Marine Outside Type (Salt Water)

ATEX/IECEX:

Zone 2 and 22
 II 2 GD
 IP66/67

Illustrated Features



Heatsink

Reliable heat transfer via the cast, epoxy powder coat aluminum body. Provides maximum heat dissipation from the LED assembly to the outside environment.



Driver Assembly

Utilizing non-sparking components avoiding the ignition of gases or vapors that may be present (nA).

Modular Plug between LED and driver.



LED Chamber

Protected by polycarbonate lens, allows for easy maintenance access.

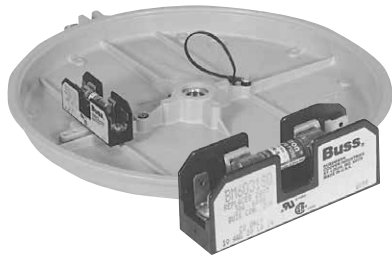

Terminal Blocks (Zone 2)

A seven-point terminal block is provided to facilitate wiring. Terminal block accommodates wire size ranging from #8 to #24AWG, 0.75 to 6 mm² (0.0012 to 0.0093 in²)

Epoxy Finish

Ballast housing, hoods and guards are copperfree aluminum with epoxy powder coat finish.



Cooler Operating Cone Hood

Larger sloped surface sheds dusts, dirt and combustible fibers providing better heat dissipation.

Fuses ①

Two screws secure fuse kit to mounting boss in any Mercmaster mounting hood. Fuse included.

Photocell ①

Available for all fixtures except cone and ceiling mount. Installs through knock-out in mounting hood. Provides continuous ON-OFF dusk-to-dawn control.

Electrical Protection

Ground wire provided to bond mounting hood to ballast housing.

Safety

Rounded heatsink edges prevent possible injury during installation.

Mounting Hood and Globe Gaskets

Silicone rubber gaskets seals out moisture, dirt and dust. Stays flexible, withstands high temperatures. Closure design assures uniform gasket compression.



"Safety" High Hinge

Extra-high hinge provides additional protection against accidental ballast housing disengagement during installation or maintenance.

Stainless Steel Latch Assembly

Captive, stainless steel latch assembly bolt and nut closes securely, resists attack of corrosive atmospheres. Swing-away design simplifies servicing.



① Fuses and photocells are available on the NEC/CEC versions only. Not for use in ATEX/IEC.

Mercmaster™ LED Series Luminaires

Enclosed and Gasketed Fixtures

NEC/CEC:

Class I, Division 2, Groups A, B, C, D
 Class I, Zone 2, AEx nA IIC
 Class II, Division 1, Group E, F, G
 Class II, Division 2, Group F, G
 Class III

NEC/CEC:

Type 3R, 4, 4X
 IP66/67
 Simultaneous Exposure
 Suitable for Use in Wet Locations
 Marine Outside Type (Salt Water)

ATEX/IECEX:

Zone 2 and 22
 11 2 GD
 IP66/67

Mercmaster LED Family Tree

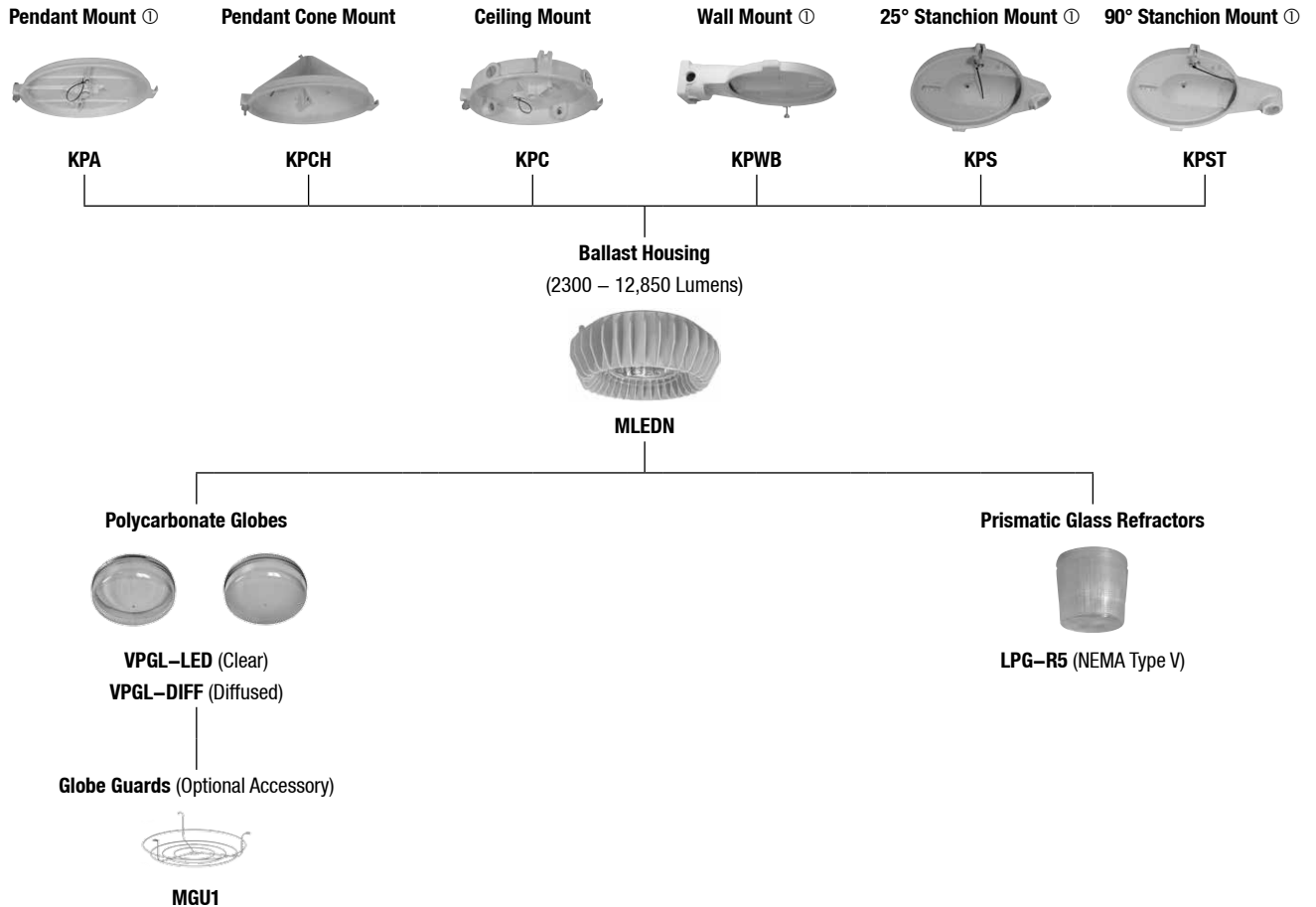

Appleton

LED/AREA: NEC/CEC, ATEX/IECEX ENCLOSED AND GASKETED

① Mounting hood with a 120 V or 208-277 V factory installed photocell is available.

Mercmaster™ LED Series Luminaires

Enclosed and Gasketed Fixtures

NEC/CEC:

Class I, Division 2, Groups A, B, C, D
 Class I, Zone 2, AEx nA IIC
 Class II, Division 1, Group E, F, G
 Class II, Division 2, Group F, G
 Class III

NEC/CEC:

Type 3R, 4, 4X
 IP66/67
 Simultaneous Exposure
 Suitable for Use in Wet Locations
 Marine Outside Type (Salt Water)

ATEX/IECEx:

Zone 2 and 22
 Ⓢ II 2 GD
 IP66/67

Order using catalog numbering guides below or select catalog number from tables on following pages.

Catalog Numbering Guide — NEC/CEC Certified Mercmaster LED

MLEDN	A	17	2	P	5	BU	H1
MLEDN - NEC/CEC Certified Mercmaster LED Series		Light Level Equivalent: 70 - 70 W HPS/PSMH 10 - 100 W HPS/PSMH 15 - 150 W HPS/PSMH 17 - 175 W PSMH ② 25 - 250 W HPS/PSMH 35 - 350 W PSMH ⑥ 40 - 400 W HPS/PSMH ⑦		Optical Assembly: P - Polycarbonate Globe		Voltage: BU - Universal Voltages 120-277 Vac, 50/60 Hz BH - 347-480 Vac, 50/60 Hz	
	Mounting: A - Pendant C - Ceiling ① D - Pendant Cone R - 90° Stanchion S - 25° Stanchion W - Wall		Hub Size: 2 - 3/4" NPT 3 - 1" NPT 4 - 1-1/4" NPT stanchion 5 - 1-1/2" NPT stanchion 6 - Metric M20		Light Distribution: 1 - NEMA Type I Elliptical (100 W HPS and 175 W PSMH Only) 5 - NEMA Type V Symmetrical		Options: D - Diffused Globe F - Fusing ③ H1 - Photocontrol 120 V ④ H2 - Photocontrol 208 V ④ H3 - Photocontrol 240 V ④ H4 - Photocontrol 277 V ④

Catalog Numbering Guide — ATEX/IECEx Certified Mercmaster LED ⑤

MLEDNA	—	17	—	P	5	BU	D
MLEDNA - ATEX/IECEx Certified Mercmaster LED Series		Light Level Equivalent: 70 - 70 W HPS/PSMH 10 - 100 W HPS/PSMH 15 - 150 W HPS/PSMH 17 - 175 W PSMH ② 25 - 250 W HPS/PSMH		Optical Assembly: P - Polycarbonate Globe		Voltage: BU - Universal Voltages 120-277 Vac, 50/60 Hz	
	Mounting: ATEX/IECEx version is not available as a complete fixture (not sold with mounting hood)		Hub Size: ATEX/IECEx version is not available as a complete fixture (hub size does not apply)		Light Distribution: 5 - NEMA Type V Symmetrical		Options: D - Diffused Globe

① Ceiling mount luminaires are not designed to use the PCD2 photocontrol. Ceiling mounts must use an FS/FD box with a photocontrol. Contact your local sales representative for more information.

② 175 W Pulse Start Metal Halide only. Does not have a High Pressure Sodium equivalent.

③ Canadian Electrical Code does NOT allow fusing in hazardous locations. Fuse not CEC rated.

④ Luminaires with photocontrol are not rated IP66/67 or marine outside type (salt water).

⑤ For ATEX/IECEx rated fixtures, ballast bodies and mounting hoods must be purchased separately.

⑥ Available for use with the BH voltage only (347-480 Vac, 50/60 Hz).

⑦ Available for use with the BU voltage only (120-277 Vac, 50/60 Hz).

Mercmaster™ LED Series Luminaires

Enclosed and Gasketed Fixtures

NEC/CEC:
 Class I, Division 2, Groups A, B, C, D
 Class I, Zone 2, AEx nA IIC
 Class II, Division 1, Group E, F, G
 Class II, Division 2, Group F, G
 Class III

NEC/CEC:
 Type 3R, 4, 4X
 IP66/67
 Simultaneous Exposure
 Suitable for Use in Wet Locations
 Marine Outside Type (Salt Water)

ATEX/IECEX:
 Zone 2 and 22
 Ⓢ II 2 GD
 IP66/67

Technical Data

Lamp		Ambient Temperature °C (°F)	Supply Wire Temperature °C (°F)	NEC/CEC				ATEX/IECEX			
Light Level Equivalent to HID	Type			Class I, Division 2 ①	Gas Groups	Class I, Zone 2, AEx nA IIC, Ex nA IIC	Class II, Division 1 and 2 ②	Dust Groups	Gas/Dust Simultaneous ① Class I, Division 2/ Class II, Division 1	Gas Ex II 3G ① nA	Dust Ex II 3D ② Ex tc IIIC
70 Watt NEMA Type V	LED	40 (104)	60 (140)	T4A	A, B, C, D	T4	T6	E, F, G	T4	T4	T92°C (T197.6°F) Dc
		55 (131)	75 (167)	T4		T4	T6		T4		
		65 (149)	90 (194)	T3C		T3	T6		T3C		
100 Watt NEMA Type V	LED	40 (104)	60 (140)	T4A	A, B, C, D	T4	T6	E, F, G	T4	T4	T92°C (T197.6°F) Dc
		55 (131)	75 (167)	T4		T4	T6		T4		
		65 (149)	90 (194)	T3C		T3	T6		T3C		
100 Watt NEMA Type I ③	LED	40 (104)	60 (140)	T4	A, B, C, D	T4	T5	E, F, G	T4	—	—
		55 (31)	75 (167)	T3C		T3	T5		T3C	—	
		65 (143)	90 (194)	T3C		T3	T4A		T3C	—	
150 Watt NEMA Type V	LED	40 (104)	60 (140)	T4A	A, B, C, D	T4	T6	E, F, G	T4	T6	T92°C (T197.6°F) Dc IP66
		55 (131)	75 (167)	T4		T4	T6		T4	T6	
175 Watt NEMA Type V	LED	40 (104)	60 (140)	T4A	A, B, C, D	T4	T6	E, F, G	T4	T6	T92°C (T197.6°F) Dc IP66
		55 (131)	75 (167)	T4		T4	T6		T4	T6	
175 Watt NEMA Type I ③	LED	40 (104)	60 (140)	T4	A, B, C, D	T4	T5	E, F, G	T4	—	—
		55 (131)	75 (167)	T3C		T3	T5		T3C	—	
250 Watt NEMA Type V ③	LED	40 (104)	60 (140)	T4A	A, B, C, D	T4	T6	E, F, G	T4A	T4	T79°C (T174.2°F) Dc
		50 (122)	75 (167)	T4		T4	T6		T4	T4	
350 Watt NEMA Type V ③	LED	40 (104)	75 (167)	T3A	A, B, C, D	T3	—	—	—	—	—
		50 (122)	75 (167)	T3		T3	—		—	—	
400 Watt NEMA Type V ③	LED	40 (104)	75 (167)	T3A	A, B, C, D	T3	—	—	—	—	—
		55 (131)	75 (167)	T3		T3	—		—	—	

“T” Numbers Represent the Maximum Internal Temperature ① or Maximum Surface Temperature ②

“T” #	NEC/CEC															
	T1	350	325	T2	T2A	T2B	T2C	T2D	T3	T3A	T3B	T3C	T4	T4A	T5	T6
Temp. Range °C (°F)	351-450 (664-842)	326-350 (619-662)	301-325 (574-617)	281-300 (538-572)	261-280 (502-536)	231-260 (448-500)	216-230 (421-446)	201-215 (394-419)	181-200 (358-392)	166-180 (331-356)	161-165 (322-329)	136-160 (277-320)	121-135 (250-275)	101-120 (214-248)	86-100 (187-212)	85 (185)

“T” #	ATEX/IECEX					
	T1	T2	T3	T4	T5	T6
Temp. Range °C (°F)	301-450 (547-842)	201-300 (394-572)	136-200 (277-392)	101-135 (214-275)	86-100 (187-212)	85 (185)

① T numbers represent the maximum internal temperature for Class I, Division 2 and Class I, Zone 2 locations designated by the NEC.

② T numbers represent the maximum surface temperature under a dust blanket for Class II, Division 1 and Class I, Zone 2 as designated by the NEC or Zone 2 (Gas) and 22 (Dust) locations as designated by the IEC.

③ Lamp type is not certified for use in ATEX/IECEX.

Mercmaster™ LED Series Luminaires

Enclosed and Gasketed Fixtures

NEC/CEC:
 Class I, Division 2, Groups A, B, C, D
 Class I, Zone 2, AEx nA IIC
 Class II, Division 1, Group E, F, G
 Class II, Division 2, Group F, G
 Class III

NEC/CEC:
 Type 3R, 4, 4X
 IP66/67
 Simultaneous Exposure
 Suitable for Use in Wet Locations
 Marine Outside Type (Salt Water)

ATEX/IECEX:
 Zone 2 and 22
 II 2 GD
 IP66/67

Lamp Comparison Chart

Lamp Data	Line Current Amps	Input Power	Lumens	CRI	Lamp Life (Hours)	Color Temp CCT
NEMA Type V						
MLEDN70	.31 @ 120 V	35	2300	70	60,000+	5650
	.17 @ 277 V	33				
	.24 @ 347 V	34				
	.11 @ 480 V	32				
MLEDN100	.41 @ 120 V	47.5	3450	70	60,000+	5650
	.20 @ 277 V	46				
	.25 @ 347 V	42				
	.12 @ 480 V	44				
MLEDN150	.53 @ 120 V	61	4850	70	60,000+	5650
	.25 @ 277 V	62				
	.29 @ 347 V	62				
	.14 @ 480 V	64				
MLEDN175	.63 @ 120 V	74	6076	70	60,000+	5650
	.28 @ 277 V	72				
	.25 @ 347 V	86				
	.16 @ 480 V	88				
MLEDN250 ①	.83 @ 120 V	95.5	9455	70	60,000+	5650
	.36 @ 277 V	92				
	.45 @ 347 V	96				
	.31 @ 480 V	95				
MLEDN350 ①	.30 @ 347 V	102	11425	70	60,000+	5650
	.23 @ 480 V	103				
MLEDN400	1.04 @ 120 V	127	12850	70	60,000+	5650
	.47 @ 277 V	128				
NEMA Type I						
MLEDN100 ①	.41 @ 120 V	47.5	2900	70	60,000+	5650
	.20 @ 277 V	46				
	.25 @ 347 V	47.5				
	.12 @ 480 V	46				
MLEDN175 ①	.61 @ 120 V	70	6200	70	60,000+	5650
	.28 @ 277 V	69				
	.24 @ 347 V	70				
	.16 @ 480 V	69				



① Lamp type is not certified for use in ATEX/IEC.

Mercmaster™ LED Series Luminaires

Enclosed and Gasketed Fixtures

NEC/CEC:
 Class I, Division 2, Groups A, B, C, D
 Class I, Zone 2, AEx nA IIC
 Class II, Division 1, Group E, F, G
 Class II, Division 2, Group F, G
 Class III

NEC/CEC:
 Type 3R, 4, 4X
 IP66/67
 Simultaneous Exposure
 Suitable for Use in Wet Locations
 Marine Outside Type (Salt Water)

	LED Wattage BU/BH	Lamp Wattage Equivalent	NEMA Type	Hub Size	Conformance	NEC/CEC Catalog Numbers ②③④⑤
Pendant — One Hub, Rigid Mounting						
	35/33 W	70 W HPS/PSMH	Type V	3/4	NEC/CEC	MLEDNA702P5
	47.5/46 W	100 W HPS/PSMH	Type V	3/4	NEC/CEC	MLEDNA102P5
	46.7/46.6 W	100 W HPS/PSMH	Type I	3/4	NEC/CEC	MLEDNA102P1 ①
	61/62 W	150 W HPS/PSMH	Type V	3/4	NEC/CEC	MLEDNA152P5
	74/72 W	175 W PSMH	Type V	3/4	NEC/CEC	MLEDNA172P5
	70/69 W	175 W PSMH	Type I	3/4	NEC/CEC	MLEDNA172P1 ①
	95.5/92 W	250 W HPS/MH	Type V	3/4	NEC/CEC	MLEDNA252P5
	102/103 W	350 W PSMH	Type V	3/4	NEC/CEC	MLEDNA352P5 ⑥
	127/128 W	400 W HPS/PSMH	Type V	3/4	NEC/CEC	MLEDNA402P5 ⑦
	35/33 W	70 W HPS/PSMH	Type V	1	NEC/CEC	MLEDNA703P5
	47.5/46 W	100 W HPS/PSMH	Type V	1	NEC/CEC	MLEDNA103P5
	46.7/46.6 W	100 W HPS/PSMH	Type I	1	NEC/CEC	MLEDNA103P1 ①
	61/62 W	150 W HPS/PSMH	Type V	1	NEC/CEC	MLEDNA153P5
	74/72 W	175 W PSMH	Type V	1	NEC/CEC	MLEDNA173P5
70/64 W	175 W PSMH	Type I	1	NEC/CEC	MLEDNA173P1 ①	
95.5/92 W	250 W HPS/PSMH	Type V	1	NEC/CEC	MLEDNA253P5	
102/103 W	350 W PSMH	Type V	1	NEC/CEC	MLEDNA353P5 ⑥	
127/128 W	400 W HPS/PSMH	Type V	1	NEC/CEC	MLEDNA403P5 ⑦	
Pendant Cone — One Hub, Rigid Mounting						
	35/33 W	70 W HPS/PSMH	Type V	3/4	NEC/CEC	MLEDND702P5
	47.5/46 W	100 W HPS/PSMH	Type V	3/4	NEC/CEC	MLEDND102P5
	46.7/46.6 W	100 W HPS/PSMH	Type I	3/4	NEC/CEC	MLEDND102P1 ①
	61/62 W	150 W HPS/PSMH	Type V	3/4	NEC/CEC	MLEDND152P5
	74/72 W	175 W PSMH	Type V	3/4	NEC/CEC	MLEDND172P5
	70/64 W	175 W PSMH	Type I	3/4	NEC/CEC	MLEDND172P1 ①
	95.5/92 W	250 W HPS/PSMH	Type V	3/4	NEC/CEC	MLEDND252P5
	102/103 W	350 W PSMH	Type V	3/4	NEC/CEC	MLEDNW352P5 ⑥
	127/128 W	400 W HPS/PSMH	Type V	3/4	NEC/CEC	MLEDNW402P5 ⑦
	35/33 W	70 W HPS/PSMH	Type V	1	NEC/CEC	MLEDND703P5
	47.5/46 W	100 W HPS/PSMH	Type V	1	NEC/CEC	MLEDND103P5
	46.7/46.6 W	100 W HPS/PSMH	Type I	1	NEC/CEC	MLEDND103P1 ①
	61/62 W	150 W HPS/PSMH	Type V	1	NEC/CEC	MLEDND153P5
	74/72 W	175 W PSMH	Type V	1	NEC/CEC	MLEDND173P5
70/64 W	175 W PSMH	Type I	1	NEC/CEC	MLEDND173P1 ①	
95.5/92 W	250 W HPS/PSMH	Type V	1	NEC/CEC	MLEDND253P5	
102/103 W	350 W PSMH	Type V	1	NEC/CEC	MLEDND353P5 ⑥	
127/128 W	400 W HPS/PSMH	Type V	1	NEC/CEC	MLEDND403P5 ⑦	

① NEMA Type I Elliptical.

② Voltage specifications: for 120-277 Vac, 50/60 Hz universal voltages add **-BU** to the end of the catalog number. For 347-480 Vac, 50/60 Hz add **-BH** to the end of the catalog number. Example: MLEDNA702P5BU.

③ For optional diffused globe, add suffix **-D** to the end of the catalog number.

④ For optional fusing, add suffix **-F** to the end of the catalog number. The Canadian Electrical Code does NOT allow fusing in hazardous locations. Fuse not CEC rated.

⑤ For optional photocontrols add the appropriate suffix to the end of the catalog number: **-H1** for 120 V; **-H2** for 208 V; **-H3** for 240 V; **-H4** for 277 V. Luminaires with photocontrol are not rated IP66/67, Type 4X or marine outside type (salt water). Ceiling mount luminaires are not designed to use the PCD2 photocontrol. Ceiling mounts must use an FS/FD box with a photocontrol. Contact your local sales representative for more information.

⑥ Available for use with the BH voltage only (347-480 Vac, 50/60 Hz).

⑦ Available for use with the BU voltage only (120-277 Vac, 50/60 Hz).

Mercmaster™ LED Series Luminaires

Enclosed and Gasketed Fixtures

NEC/CEC:

Class I, Division 2, Groups A, B, C, D
 Class I, Zone 2, AEx nA IIC
 Class II, Division 1, Group E, F, G
 Class II, Division 2, Group F, G
 Class III

NEC/CEC:

Type 3R, 4, 4X
 IP66/67
 Simultaneous Exposure
 Suitable for Use in Wet Locations
 Marine Outside Type (Salt Water)

	LED Wattage BU/BH	Lamp Wattage Equivalent	NEMA Type	Hub Size	Conformance	NEC/CEC Catalog Numbers ②③④⑤
Ceiling — Five Hubs, Four Close-up Plugs						
	35/33 W	70 W HPS/PSMH	Type V	3/4	NEC/CEC	MLEDNC702P5
	47.5/46 W	100 W HPS/PSMH	Type V	3/4	NEC/CEC	MLEDNC102P5
	46.7/46.6 W	100 W HPS/PSMH	Type I	3/4	NEC/CEC	MLEDNC102P1 ①
	61/62 W	150 W HPS/PSMH	Type V	3/4	NEC/CEC	MLEDNC152P5
	74/72 W	175 W PSMH	Type V	3/4	NEC/CEC	MLEDNC172P5
	70/64 W	175 W PSMH	Type I	3/4	NEC/CEC	MLEDNC172P1 ①
	95.5/92 W	250 W HPS/PSMH	Type V	3/4	NEC/CEC	MLEDNC252P5
	102/103 W	350 W PSMH	Type V	3/4	NEC/CEC	MLEDNC352P5 ⑥
	127/128 W	400 W HPS/PSMH	Type V	3/4	NEC/CEC	MLEDNC402P5 ⑦
	35/33 W	70 W HPS/PSMH	Type V	1	NEC/CEC	MLEDNC703P5
	47.5/46 W	100 W HPS/PSMH	Type V	1	NEC/CEC	MLEDNC103P5
	46.7/46.6 W	100 W HPS/PSMH	Type I	1	NEC/CEC	MLEDNC103P1 ①
	61/62 W	150 W HPS/PSMH	Type V	1	NEC/CEC	MLEDNC153P5
	74/72 W	175 W PSMH	Type V	1	NEC/CEC	MLEDNC173P5
70/64 W	175 W PSMH	Type I	1	NEC/CEC	MLEDNC173P1 ①	
95.5/92 W	250 W HPS/PSMH	Type V	1	NEC/CEC	MLEDNC253P5	
102/103 W	350 W PSMH	Type V	1	NEC/CEC	MLEDNC353P5 ⑥	
127/128 W	400 W HPS/PSMH	Type V	1	NEC/CEC	MLEDNC403P5 ⑦	

Wall — Five Hubs, Four Close-up Plugs						
	35/33 W	70 W HPS/PSMH	Type V	3/4	NEC/CEC	MLEDNW702P5
	47.5/46 W	100 W HPS/PSMH	Type V	3/4	NEC/CEC	MLEDNW102P5
	46.7/46.6 W	100 W HPS/PSMH	Type I	3/4	NEC/CEC	MLEDNW102P1 ①
	61/62 W	150 W HPS/PSMH	Type V	3/4	NEC/CEC	MLEDNW152P5
	74/72 W	175 W PSMH	Type V	3/4	NEC/CEC	MLEDNW172P5
	70/64 W	175 W PSMH	Type I	3/4	NEC/CEC	MLEDNW172P1 ①
	95.5/92 W	250 W HPS/PSMH	Type V	3/4	NEC/CEC	MLEDNW252P5
	102/103 W	350 W PSMH	Type V	3/4	NEC/CEC	MLEDNW352P5 ⑥
	127/128 W	400 W HPS/PSMH	Type V	3/4	NEC/CEC	MLEDNW402P5 ⑦
	35/33 W	70 W HPS/PSMH	Type V	1	NEC/CEC	MLEDNW703P5
	47.5/46 W	100 W HPS/PSMH	Type V	1	NEC/CEC	MLEDNW103P5
	46.7/46.6 W	100 W HPS/PSMH	Type I	1	NEC/CEC	MLEDNW103P1 ①
	61/62 W	150 W HPS/PSMH	Type V	1	NEC/CEC	MLEDNW153P5
	74/72 W	175 W PSMH	Type V	1	NEC/CEC	MLEDNW173P5
70/64 W	175 W PSMH	Type I	1	NEC/CEC	MLEDNW173P1 ①	
95.5/92 W	250 W HPS/PSMH	Type V	1	NEC/CEC	MLEDNW253P5	
102/103 W	350 W PSMH	Type V	1	NEC/CEC	MLEDNW353P5 ⑥	
127/128 W	400 W HPS/PSMH	Type V	1	NEC/CEC	MLEDNW403P5 ⑦	

① NEMA Type I Elliptical.

② Voltage specifications: for 120-277 Vac, 50/60 Hz universal voltages add **-BU** to the end of the catalog number. For 347-480 Vac, 50/60 Hz add **-BH** to the end of the catalog number. Example: MLEDNA702P5BU.

③ For optional diffused globe, add suffix **-D** to the end of the catalog number.

④ For optional fusing, add suffix **-F** to the end of the catalog number. The Canadian Electrical Code does NOT allow fusing in hazardous locations. Fuse not CEC rated.

⑤ For optional photocontrols add the appropriate suffix to the end of the catalog number: **-H1** for 120 V; **-H2** for 208 V; **-H3** for 240 V; **-H4** for 277 V. Luminaires with photocontrol are not rated IP66/67, Type 4X or marine outside type (salt water). Ceiling mount luminaires are not designed to use the PCD2 photocontrol. Ceiling mounts must use an FS/FD box with a photocontrol. Contact your local sales representative for more information.

⑥ Available for use with the BH voltage only (347-480 Vac, 50/60 Hz).

⑦ Available for use with the BU voltage only (120-277 Vac, 50/60 Hz).

Mercmaster™ LED Series Luminaires



Enclosed and Gasketed Fixtures

NEC/CEC:

Class I, Division 2, Groups A, B, C, D
 Class I, Zone 2, AEx nA IIC
 Class II, Division 1, Group E, F, G
 Class II, Division 2, Group F, G
 Class III

NEC/CEC:

Type 3R, 4, 4X
 IP66/67
 Simultaneous Exposure
 Suitable for Use in Wet Locations
 Marine Outside Type (Salt Water)

	LED Wattage BU/BH	Lamp Wattage Equivalent	NEMA Type	Hub Size	Conformance	NEC/CEC Catalog Numbers ②③④⑤
25° Stanchion — One Hub						
	35/33 W	70 W HPS/PSMH	Type V	1-1/4	NEC/CEC	MLEDNS704P5
	47.5/46 W	100 W HPS/PSMH	Type V	1-1/4	NEC/CEC	MLEDNS104P5
	46.7/46.6 W	100 W HPS/PSMH	Type I	1-1/4	NEC/CEC	MLEDNS104P1 ①
	61/62 W	150 W HPS/PSMH	Type V	1-1/4	NEC/CEC	MLEDNS154P5
	74/72 W	175 W PSMH	Type V	1-1/4	NEC/CEC	MLEDNS174P5
	70/64 W	175 W PSMH	Type I	1-1/4	NEC/CEC	MLEDNS174P1 ①
	95.5/92 W	250 W HPS/PSMH	Type V	1-1/4	NEC/CEC	MLEDNS254P5
	102/103 W	350 W PSMH	Type V	1-1/4	NEC/CEC	MLEDNS354P5 ⑥
	127/128 W	400 W HPS/PSMH	Type V	1-1/4	NEC/CEC	MLEDNS404P5 ⑦
	35/33 W	70 W HPS/PSMH	Type V	1-1/2	NEC/CEC	MLEDNS705P5
	47.5/46 W	100 W HPS/PSMH	Type V	1-1/2	NEC/CEC	MLEDNS105P5
	46.7/46.6 W	100 W HPS/PSMH	Type I	1-1/2	NEC/CEC	MLEDNS105P1 ①
	61/62 W	150 W HPS/PSMH	Type V	1-1/2	NEC/CEC	MLEDNS155P5
	74/72 W	175 W PSMH	Type V	1-1/2	NEC/CEC	MLEDNS175P5
70/64 W	175 W PSMH	Type I	1-1/2	NEC/CEC	MLEDNS175P1 ①	
95.5/92 W	250 W HPS/PSMH	Type V	1-1/2	NEC/CEC	MLEDNS255P5	
102/103 W	350 W PSMH	Type V	1-1/2	NEC/CEC	MLEDNS355P5 ⑥	
127/128 W	400 W HPS/PSMH	Type V	1-1/2	NEC/CEC	MLEDNS405P5 ⑦	
90° Stanchion — One Hub						
	35/33 W	70 W HPS/PSMH	Type V	1-1/4	NEC/CEC	MLEDNR704P5
	47.5/46 W	100 W HPS/PSMH	Type V	1-1/4	NEC/CEC	MLEDNR104P5
	46.7/46.6 W	100 W HPS/PSMH	Type I	1-1/4	NEC/CEC	MLEDNR104P1 ①
	61/62 W	150 W HPS/PSMH	Type V	1-1/4	NEC/CEC	MLEDNR154P5
	74/72 W	175 W PSMH	Type V	1-1/4	NEC/CEC	MLEDNR174P5
	70/64 W	175 W PSMH	Type I	1-1/4	NEC/CEC	MLEDNR174P1 ①
	95.5/92 W	250 W HPS/PSMH	Type V	1-1/4	NEC/CEC	MLEDNR254P5
	102/103 W	350 W PSMH	Type V	1-1/4	NEC/CEC	MLEDNR354P5 ⑥
	127/128 W	400 W HPS/PSMH	Type V	1-1/4	NEC/CEC	MLEDNR404P5 ⑦
	35/33 W	70 W HPS/PSMH	Type V	1-1/2	NEC/CEC	MLEDNR705P5
	47.5/46 W	100 W HPS/PSMH	Type V	1-1/2	NEC/CEC	MLEDNR105P5
	46.7/46.6 W	100 W HPS/PSMH	Type I	1-1/2	NEC/CEC	MLEDNR105P1 ①
	61/62 W	150 W HPS/PSMH	Type V	1-1/2	NEC/CEC	MLEDNR155P5
	74/72 W	175 W PSMH	Type V	1-1/2	NEC/CEC	MLEDNR175P5
70/64 W	175 W PSMH	Type I	1-1/2	NEC/CEC	MLEDNR175P1 ①	
95.5/92 W	250 W HPS/PSMH	Type V	1-1/2	NEC/CEC	MLEDNR255P5	
102/103 W	350 W PSMH	Type V	1-1/2	NEC/CEC	MLEDNR355P5 ⑥	
127/128 W	400 W HPS/PSMH	Type V	1-1/2	NEC/CEC	MLEDNR405P5 ⑦	

① NEMA Type I Elliptical.

② Voltage specifications: for 120-277 Vac, 50/60 Hz universal voltages add **-BU** to the end of the catalog number. For 347-480 Vac, 50/60 Hz add **-BH** to the end of the catalog number. Example: MLEDNA702P5BU.

③ For optional diffused globe, add suffix **-D** to the end of the catalog number.

④ For optional fusing, add suffix **-F** to the end of the catalog number. The Canadian Electrical Code does NOT allow fusing in hazardous locations. Fuse not CEC rated.

⑤ For optional photocontrols add the appropriate suffix to the end of the catalog number: **-H1** for 120 V; **-H2** for 208 V; **-H3** for 240 V; **-H4** for 277 V. Luminaires with photocontrol are not rated IP66/67, Type 4X or marine outside type (salt water). Ceiling mount luminaires are not designed to use the PCD2 photocontrol. Ceiling mounts must use an FS/FD box with a photocontrol. Contact your local sales representative for more information.

⑥ Available for use with the BH voltage only (347-480 Vac, 50/60 Hz).

⑦ Available for use with the BU voltage only (120-277 Vac, 50/60 Hz).

Mercmaster™ LED Series Luminaires

Enclosed and Gasketed Fixtures

NEC/CEC:
 Class I, Division 2, Groups A, B, C, D
 Class I, Zone 2, AEx nA IIC
 Class II, Division 1, Group E, F, G
 Class II, Division 2, Group F, G
 Class III

NEC/CEC:
 Type 3R, 4, 4X
 IP66/67
 Simultaneous Exposure
 Suitable for Use in Wet Locations
 Marine Outside Type (Salt Water)

Fixture Unit — Electrical Specification



LED Wattage BU/BH	Light Level Equivalent	NEMA Type	Current Draw	Catalog Number			Voltage Range	Voltage Suffix
				Fuse Kit ①	Fixture Unit	Conformance		
NEC/CEC Certified Ballast Housing								
35/33 W	70 W HPS	Type V	120 Vac @ .31 Amps 277 Vac @ .17 Amps	F3	MLEDN70P5	NEC/CEC	120-277 Vac, 50/60 Hz	BU
34/32 W	70 W HPS	Type V	347 Vac @ .24 Amps 480 Vac @ .11 Amps	F3	MLEDN70P5	NEC/CEC	347-480 Vac, 50/60 Hz	BH
47.5/46 W	100 W HPS	Type V	120 Vac @ .41 Amps 277 Vac @ .20 Amps	F3	MLEDN10P5	NEC/CEC	120-277 Vac, 50/60 Hz	BU
47.5/46 W	100 W HPS	Type I	120 Vac @ .41 Amps 277 Vac @ .20 Amps	F3	MLEDN10P1	NEC/CEC	120-277 Vac, 50/60 Hz	BU
42/44 W	100 W HPS	Type V	347 Vac @ .25 Amps 480 Vac @ .12 Amps	F3	MLEDN10P5	NEC/CEC	347-480 Vac, 50/60 Hz	BH
47.5/46 W	100 W HPS	Type I	347 Vac @ .25 Amps 480 Vac @ .12 Amps	F3	MLEDN10P1	NEC/CEC	347-480 Vac, 50/60 Hz	BH
61/62 W	150 W HPS	Type V	120 Vac @ .53 Amps 277 Vac @ .25 Amps	F3	MLEDN15P5	NEC/CEC	120-277 Vac, 50/60 Hz	BU
62/64 W	150 W HPS	Type V	347 Vac @ .29 Amps 480 Vac @ .14 Amps	F3	MLEDN15P5	NEC/CEC	347-480 Vac, 50/60 Hz	BH
74/72 W	175 W PSMH	Type V	120 Vac @ .63 Amps 277 Vac @ .28 Amps	F3	MLEDN17P5	NEC/CEC	120-277 Vac, 50/60 Hz	BU
70/69 W	175 W PSMH	Type I	120 Vac @ .61 Amps 277 Vac @ .28 Amps	F3	MLEDN17P1	NEC/CEC	120-277 Vac, 50/60 Hz	BU
86/88 W	175 W PSMH	Type V	347 Vac @ .25 Amps 480 Vac @ .16 Amps	F3	MLEDN17P5	NEC/CEC	347-480 Vac, 50/60 Hz	BH
70/69 W	175 W PSMH	Type I	347 Vac @ .24 Amps 480 Vac @ .16 Amps	F3	MLEDN17P1	NEC/CEC	347-480 Vac, 50/60 Hz	BH
95.5/92 W	250 W HPS/PSMH	Type V	120 Vac @ .83 Amps 277 Vac @ .36 Amps	F3	MLEDN25P5	NEC/CEC	120-277 Vac, 50/60 Hz	BU
96/95 W	250 W HPS/PSMH	Type V	347 Vac @ .45 Amps 480 Vac @ .31 Amps	F3	MLEDN25P5	NEC/CEC	347-480 Vac, 50/60 Hz	BH
102/103 W	350 W PSMH	Type V	347 Vac @ .30 Amps 480 Vac @ .23 Amps	F3	MLEDN35P5	NEC/CEC	347-480 Vac, 50/60 Hz	BH
127/128 W	400 W HPS/PSMH	Type V	120 Vac @ 1.04 Amps 277 Vac @ .47 Amps	F3	MLEDN40P5	NEC/CEC	120-277 Vac, 50/60 Hz	BU

① Canadian Electrical Code does NOT allow fusing in hazardous locations. Fuse not CEC rated.

Mercmaster™ LED Series Luminaires

Enclosed and Gasketed Fixtures

ATEX/IECEX:
Zone 2 and 22
II 2 GD
IP66/67

Fixture Unit — Electrical Specification



LED Wattage BU/BH	Light Level Equivalent	NEMA Type	Current Draw	Conformance	Voltage Range	Voltage Suffix	Fixture Unit Catalog Number
ATEX/IECEX Certified Ballast Housing ①							
35/33 W	70 W HPS	Type V	120 Vac @ .31 Amps 277 Vac @ .17 Amps	ATEX/IECEX	120-277 Vac, 50/60 Hz	BU	MLEDNA70P5
47.5/46 W	100 W HPS	Type V	120 Vac @ .41 Amps 277 Vac @ .20 Amps	ATEX/IECEX	120-277 Vac, 50/60 Hz	BU	MLEDNA10P5
61/62 W	150 W HPS	Type V	120 Vac @ .53 Amps 277 Vac @ .25 Amps	ATEX/IECEX	120-277 Vac, 50/60 Hz	BU	MLEDNA15P5
74/72 W	175 W PSMH	Type V	120 Vac @ .63 Amps 277 Vac @ .28 Amps	ATEX/IECEX	120-277 Vac, 50/60 Hz	BU	MLEDNA17P5
95.5/92 W	250 W HPS/PSMH	Type V	120 Vac @ .83 Amps 277 Vac @ .36 Amps	ATEX/IECEX	120-277 Vac, 50/60 Hz	BU	MLEDNA25P5

① For ATEX/IECEX rated fixtures, ballast bodies and mounting hoods must be purchased separately.

Mercmaster™ LED Series Luminaires

Enclosed and Gasketed Fixtures

NEC/CEC:

Class I, Division 2, Groups A, B, C, D
 Class I, Zone 2, AEx nA IIC
 Class II, Division 1, Group E, F, G
 Class II, Division 2, Group F, G
 Class III







NEC/CEC:

Type 3R, 4, 4X
 IP66/67
 Simultaneous Exposure
 Suitable for Use in Wet Locations
 Marine Outside Type (Salt Water)

ATEX/IECEX:

Zone 2 and 22
 II 2 GD
 IP66/67

Mounting Hoods ①

	Description	Hub Size	Catalog Number NEC/CEC and ATEX/IEC
Pendant			
	One Hub, Rigid Mounting	3/4 1 M20	KPA-75 KPA-100 KPA-M20
Pendant Cone			
	One Hub, Rigid Mounting	3/4 1 M20	KPCH-75 KPCH-100 KPCH-M20
Ceiling			
	Five Hubs, Four Close-Up Plugs	3/4 1 M20	KPC-75 KPC-100 KPC-M20
Wall			
	Five Hubs, Four Close-Up Plugs	3/4 1 M20	KPWB-75 KPWB-100 KPWB-M20
25° Stanchion			
	One Hub	1-1/4 1-1/2	KPS-125 KPS-150
90° Stanchion			
	One Hub	1-1/4 1-1/2	KPST-125 KPST-150

Mercmaster LED Ballast and Mounting Hood Weights

Description	Weight kg (lb)
Fixture Unit (Ballast Housing)	8.8 (19.4)
Pendant Mounting Hood	1.0 (2.25)
Pendant Cone Mounting Hood	1.1 (2.50)
Ceiling Mounting Hood	1.4 (3.00)
Wall Mounting Hood	1.8 (4.00)
25° Stanchion Mounting Hood	1.5 (3.25)
90° Stanchion Mounting Hood	1.7 (3.75)

① For ATEX/IECEX rated fixtures, ballast bodies and mounting hoods must be purchased separately.

Mercmaster™ LED Series Luminaires

Enclosed and Gasketed Fixtures

NEC/CEC:

Class I, Division 2, Groups A, B, C, D
 Class I, Zone 2, AEx nA IIC
 Class II, Division 1, Group E, F, G
 Class II, Division 2, Group F, G
 Class III







NEC/CEC:

Type 3R, 4, 4X
 IP66/67
 Simultaneous Exposure
 Suitable for Use in Wet Locations
 Marine Outside Type (Salt Water)

ATEX/IECEX:

Zone 2 and 22
 II 2 GD
 IP66/67

Accessories and Replacement Parts

	Description	Catalog Number	
		NEC/CEC	ATEX/IECEX
Globes and Gaskets			
	Clear Globe	VPGL-LED	
	Diffused Globe	VPGL-DIFF	
	Globe Gasket — Silicone Rubber	KRF-GK	
Closed Prismatic Glass Refractors — All Heat-Resistant			
	NEMA Type V Light Distribution	LPG-R5	
Guards			
	Glass Globe Guard	MGU1	
	Refractor Guard	KRG2	
		Catalog Number	
	Description	NEC/CEC	ATEX/IECEX
LED Array			
	100 Watt LED Array Assembly, Type I, White LED's	MLEDN10A1W	MLEDN10A1W
	175 Watt LED Array Assembly, Type I, White LED's	MLEDN17A1W	MLEDN17A1W
	70 Watt LED Array Assembly, Type V, White LED's	MLEDN70A5W	MLEDN70A5W
	100 Watt LED Array Assembly, Type V, White LED's	MLEDN10A5W	MLEDN10A5W
	150 Watt LED Array Assembly, Type V, White LED's	MLEDN15A5W	MLEDN15A5W
	175 Watt LED Array Assembly, Type V, White LED's	MLEDN17A5W	MLEDN17A5W
	250 Watt LED Array Assembly, Type V, White LED's	MLEDN25A5W	MLEDN25A5W
	350 Watt LED Array Assembly, Type V, White LED's	MLEDN35A5W	—
	400 Watt LED Array Assembly, Type V, White LED's	MLEDN40A5W	—
Drivers			
	120-277 V Driver (70 W thru 250 W only)	MLEDNDBU	MLEDNDBU
	347-480 V Driver (70 W thru 350 W only)	MLEDNDBH	MLEDNDBH
	120-277 V Driver (400 W only)	MLEDNDBU40	—

Mercmaster™ LED Series Luminaires

Enclosed and Gasketed Fixtures

NEC/CEC:

Class I, Division 2, Groups A, B, C, D
 Class I, Zone 2, AEx nA IIC
 Class II, Division 1, Group E, F, G
 Class II, Division 2, Group F, G
 Class III

NEC/CEC:

Type 3R, 4, 4X
 IP66/67
 Simultaneous Exposure
 Suitable for Use in Wet Locations
 Marine Outside Type (Salt Water)

ATEX/IECEX:

Zone 2 and 22
 II 2 GD
 IP66/67

Dimensions in Millimeters (Inches)

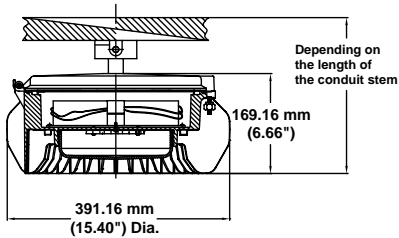

Pendant Mount

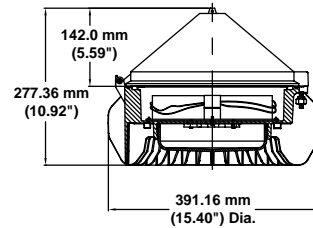

Pendant Cone Mount

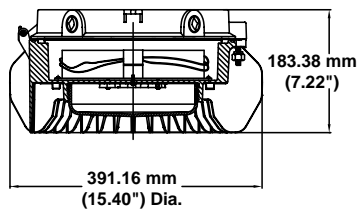

Ceiling Mount

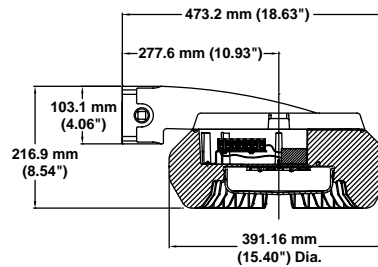

Wall Mount

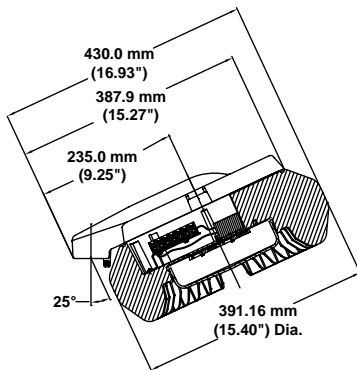

25° Stanchion Mount

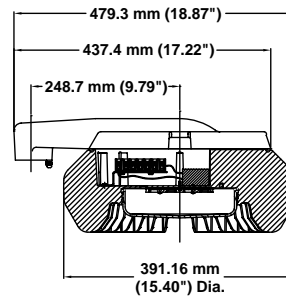

90° Stanchion Mount

PCD2 Series Factory Sealed Hazardous Location Photocontrol ^①

For Use in Class I, Division 2, Groups A, B, C, D Locations

Maintains Class I, Division 2 rating for Mercmaster III, Mercmaster III Low Profile, Mercmaster III 50-250 and 400 Series Luminaires; Mercmaster LED Series.

NEC/CEC:
Class I, Division 2, Groups A, B, C, D
NEMA 4X

Applications

- Encapsulated photocontrol provides automatic dusk-to-dawn lighting control in Class I, Division 2 locations.
- Typical applications include walkways, security areas and any other outdoor lighting application.
- For use with Mercmaster III – Low Profile, Mercmaster III, and Mercmaster III – 400 Series Luminaires.
- For remote mounting in FS Boxes.

Features

- Factory sealed design eliminates the need for an explosionproof enclosure.
- Can be easily installed in the field.
- Solid state design for performance and reliability.
- Available for 120, 208, 240, or 277 volts.

- 50-400 W HID, incandescent or fluorescent, 50/60 Hz.
- 1000 V.A. Voltage/Ampere
- Minimum time delay: 15 seconds to eliminate nuisance tripping.
- Provided with (3) 18AWG stranded leads 152.4 mm (6.00 in) length.
- Will fit through standard 1/2" knockout.
- Supplied with locknut and gasket.

Materials

- Encapsulated with epoxy sealing compound
- FS: aluminum

NEC/CEC Certifications and Compliances

- UL Standard: 1604 – Hazardous (Classified) Locations
- cULus Recognized

	Voltage Range	Max VA	Max Current Amps	Suffix Designation Catalog Number
Factory-Installed Photocontrol - Not for ceiling or pendant cone Add to fixture catalog after voltage; i.e.: KPWB1075MTH1.				
	120 V, 50/60 Hz	1000	—	H1
	208 V, 50/60 Hz	1000	—	H2
	240 V, 50/60 Hz	1000	—	H3
	277 V, 50/60 Hz	1000	—	H4

Photocontrol for Field Installation

	120 V, 50/60 Hz	1000	8.3 Amp	PC120D2
	208 V, 50/60 Hz	1000	4.8 Amp	PC247D2
	240 V, 50/60 Hz	1000	4.2 Amp	
	277 V, 50/60 Hz	1000	3.6 Amp	

Photocontrol in FS Cover for Use with FS/FD Box

Supplied with two stainless steel screws. For neoprene gasket, order catalog number **FS-GKR-1N**.

	120V, 50/60 Hz	1000	8.3 Amp	FSKA-PC120D2
	208 V, 50/60 Hz	1000	4.8 Amp	FSKA-PC247D2
	240 V, 50/60 Hz	1000	4.2 Amp	
	277 V, 50/60 Hz	1000	3.6 Amp	

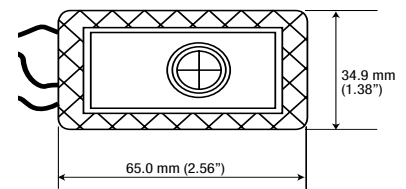
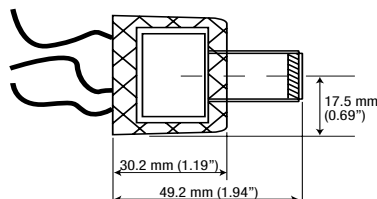
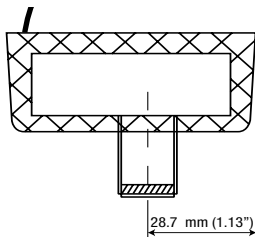

^① Fixtures with photocontrols are not rated IP66/67, Type 4X or marine outside type (salt water).
Fixtures with PCD2 photocontrols are not certified for use in ATEX/IEC governed locations.

Mercmaster™ LED Series Luminaires

Enclosed and Gasketed Fixtures

NEC/CEC:

Class I, Division 2, Groups A, B, C, D
 Class I, Zone 2, AEx nA IIC
 Class II, Division 1, Group E, F, G
 Class II, Division 2, Group F, G
 Class III

NEC/CEC:

Type 3R, 4, 4X
 IP66/67
 Simultaneous Exposure
 Suitable for Use in Wet Locations
 Marine Outside Type (Salt Water)

ATEX/IECEX:

Zone 2 and 22
 II 2 GD
 IP66/67

Photometric Data – DATA SHOWN IS ABSOLUTE

REPORT NUMBER: **MLEDN70P5BU**

Lamps: Mercmaster LED, Class I, Division 2, Polycarbonate Optic

Candela Distribution

	0.0	22.5	45.0	67.5	90.0	Flux
0	1054	1054	1054	1054	1054	
5	1048	1047	1051	1047	1048	100
15	1016	1014	1016	1014	1016	287
25	977	961	941	961	977	442
35	805	779	824	779	805	497
45	583	607	603	607	583	465
55	408	425	411	425	408	358
65	185	146	139	146	185	133
75	5	5	4	5	5	9
85	1	0	0	0	1	1
90	0	0	0	0	0	

Zonal Lumen Summary

Zone	Lumens	% Fixture
0-30	829	36.1
0-40	1326	57.7
0-60	2149	93.5
0-90	2292	99.7

CIE Type – Direct

Plane	Spacing Criteria
0-Deg	90-Deg
1.3	1.3

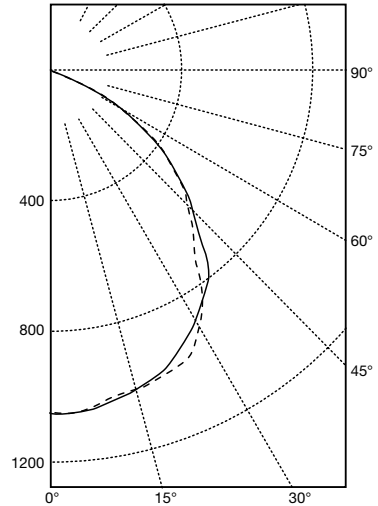

REPORT NUMBER: **MLEDN10P5BU**

Lamps: Mercmaster LED, Class I, Division 2, Polycarbonate Optic

Candela Distribution

	0.0	22.5	45.0	67.5	90.0	Flux
0	1580	1580	1580	1580	1580	
5	1569	1568	1568	1568	1569	149
15	1509	1510	1513	1510	1509	427
25	1412	1414	1437	1414	1412	655
35	1177	1215	1171	1215	1177	748
45	934	915	893	915	934	707
55	577	588	632	588	577	527
65	228	218	195	218	228	209
75	6	7	6	7	6	13
85	0	0	0	0	0	1
90	0	0	0	0	0	

Zonal Lumen Summary

Zone	Lumens	% Fixture
0-30	1231	35.8
0-40	1980	57.6
0-60	3213	93.5
0-90	3438	100.0

CIE Type – Direct

Plane	Spacing Criteria
0-Deg	90-Deg
1.2	1.2

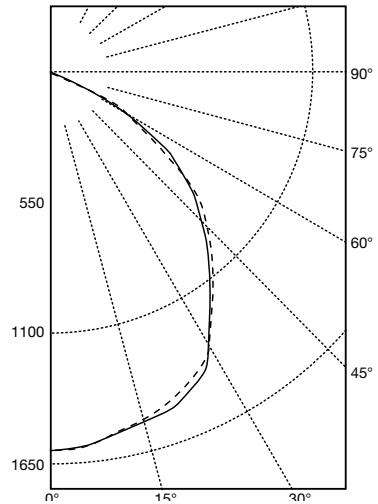

Appleton

LED/AREA: NEC/CEC, ATEX/IECEX ENCLOSED AND GASKETED

Mercmaster™ LED Series Luminaires

Enclosed and Gasketed Fixtures

NEC/CEC:

Class I, Division 2, Groups A, B, C, D
 Class I, Zone 2, AEx nA IIC
 Class II, Division 1, Group E, F, G
 Class II, Division 2, Group F, G
 Class III

NEC/CEC:

Type 3R, 4, 4X
 IP66/67
 Simultaneous Exposure
 Suitable for Use in Wet Locations
 Marine Outside Type (Salt Water)

ATEX/IECEX:

Zone 2 and 22
 II 2 GD
 IP66/67

Photometric Data – DATA SHOWN IS ABSOLUTE

REPORT NUMBER: **MLEDN10P1BU (NEMA Type I)**

Lamps: Mercmaster LED, Class I, Division 2, Polycarbonate Optic

Candela Distribution	
Zone	Lumen
0-10	276.95
10-20	715.67
20-30	650.02
30-40	492.78
40-50	369.94
50-60	232.10
60-70	127.75
70-80	22.49
80-90	2.23

CIE Type – Direct	
Plane	Spacing Criteria
0-Deg	90-Deg
0.74	0.74

Zonal Lumen Summary		
Zone	Lumens	% Fixture
0-20	992.62	34.3
0-30	1642.65	56.8
0-40	2135.42	73.8
0-60	2737.46	94.7
0-80	2887.70	99.8
0-90	2889.93	99.9

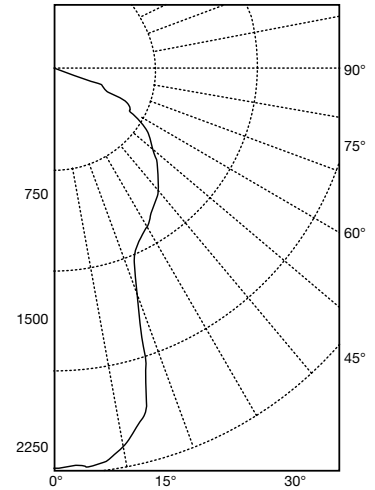

REPORT NUMBER: **MLEDN15P5BU**

Lamps: Mercmaster LED, Class I, Division 2, Polycarbonate Optic

Candela Distribution						
	0.0	22.5	45.0	67.5	90.0	Flux
0	2208	2208	2208	2208	2208	
5	2202	2195	2197	2195	2202	209
15	2137	2131	2127	2131	2137	603
25	2045	2003	1977	2003	2045	926
35	1669	1658	1735	1658	1669	1051
45	1252	1282	1297	1282	1252	988
55	836	850	838	850	834	746
65	276	307	333	307	276	298
75	16	12	11	12	16	22
85	2	1	1	1	2	2
90	1	0	0	0	1	

Zonal Lumen Summary		
Zone	Lumens	% Fixture
0-30	1738	35.8
0-40	2789	57.5
0-60	4523	93.3
0-90	4844	99.9

CIE Type – Direct	
Plane	Spacing Criteria
0-Deg	90-Deg
1.2	1.2

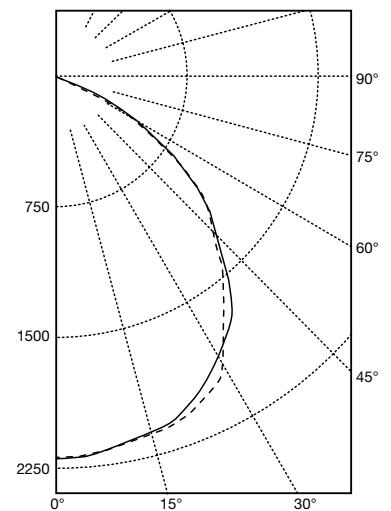

Appleton

LED/AREA: NEC/CEC, ATEX/IECEX ENCLOSED AND GASKETED

Mercmaster™ LED Series Luminaires

Enclosed and Gasketed Fixtures

NEC/CEC:

Class I, Division 2, Groups A, B, C, D
 Class I, Zone 2, AEx nA IIC
 Class II, Division 1, Group E, F, G
 Class II, Division 2, Group F, G
 Class III

NEC/CEC:

Type 3R, 4, 4X
 IP66/67
 Simultaneous Exposure
 Suitable for Use in Wet Locations
 Marine Outside Type (Salt Water)

ATEX/IECEX:

Zone 2 and 22
 II 2 GD
 IP66/67

Photometric Data – DATA SHOWN IS ABSOLUTE

REPORT NUMBER: **MLEDN17P5BU**

Lamps: Mercmaster LED, Class I, Division 2, Polycarbonate Optic

Candela Distribution

	0.0	22.5	45.0	67.5	90.0	Flux
0	2739	2739	2739	2739	2739	
5	2724	2724	2725	2724	2724	259
15	2660	2658	2655	2658	2660	752
25	2553	2508	2462	2508	2553	1156
35	2069	2062	2201	2062	2069	1312
45	1580	1614	1655	1614	1580	1243
55	1047	1093	1046	1093	1047	943
65	353	380	391	380	353	378
75	19	15	16	15	19	28
85	2	1	1	1	2	2
90	1	0	0	0	1	

Zonal Lumen Summary

Zone	Lumens	% Fixture
0-30	2167	35.7
0-40	3478	57.2
0-60	5664	93.2
0-90	6072	99.9

CIE Type – Direct

Plane	Spacing Criteria
0-Deg	90-Deg
1.2	1.2

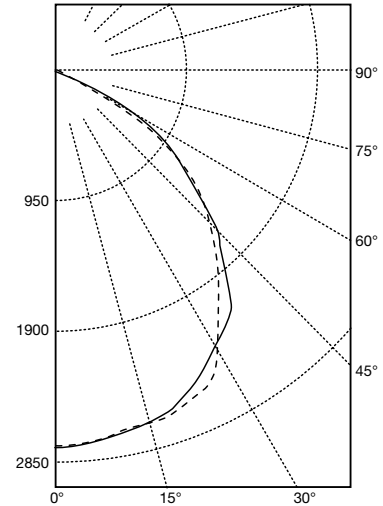

REPORT NUMBER: **MLEDN17P1BU (NEMA Type I)**

Lamps: Mercmaster LED, Class I, Division 2, Polycarbonate Optic

Candela Distribution

Zone	Lumen
0-10	546.35
10-20	1546.51
20-30	1410.19
30-40	1071.42
40-50	791.23
50-60	524.94
60-70	261.82
70-80	44.42
80-90	3.81

CIE Type – Direct

Plane	Spacing Criteria
0-Deg	90-Deg
0.84	0.84

Zonal Lumen Summary

Zone	Lumens	% Fixture
0-20	2092.86	33.70
0-30	3503.05	56.50
0-40	4574.48	73.70
0-60	5890.65	94.90
0-80	6196.88	99.90
0-90	6200.69	99.90

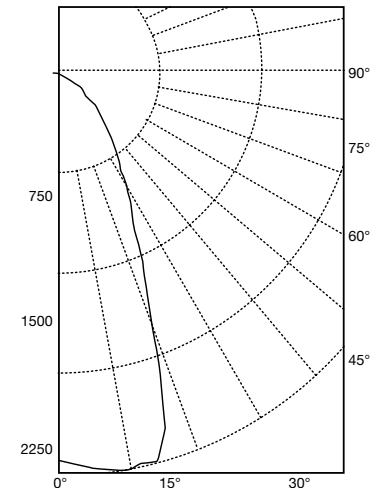

Appleton

LED/AREA: NEC/CEC, ATEX/IECEX ENCLOSED AND GASKETED

Mercmaster™ LED Series Luminaires

Enclosed and Gasketed Fixtures

NEC/CEC:

Class I, Division 2, Groups A, B, C, D
 Class I, Zone 2, AEx nA IIC
 Class II, Division 1, Group E, F, G
 Class II, Division 2, Group F, G
 Class III

NEC/CEC:

Type 3R, 4, 4X
 IP66/67
 Simultaneous Exposure
 Suitable for Use in Wet Locations
 Marine Outside Type (Salt Water)

ATEX/IECEX:

Zone 2 and 22
 Ⓢ II 2 GD
 IP66/67

Photometric Data – DATA SHOWN IS ABSOLUTE

REPORT NUMBER: **MLEDN250P5BU** ①

Lamps: Mercmaster LED, Class I, Division 2, Polycarbonate Optic

Candela Distribution						
	0.0	22.5	45.0	67.5	90.0	Flux
0	4206	4206	4206	4206	4206	
5	4170	4182	4177	4182	4170	397
15	4035	4046	4038	4046	4035	1145
25	3913	3888	3829	3888	3913	1784
35	3211	3233	3380	3233	3211	2046
45	2484	2524	2532	2524	2484	1942
55	1710	1763	1708	1763	1710	1530
65	682	564	606	564	682	568
75	20	18	17	18	20	31
85	2	1	1	1	2	2
90	1	1	0	1	1	

Zonal Lumen Summary		
Zone	Lumens	% Fixture
0-30	3326	35.2
0-40	5372	56.8
0-60	8844	93.5
0-90	9445	99.9

CIE Type – Direct	
Plane	Spacing Criteria
0-Deg	90-Deg
1.2	1.2

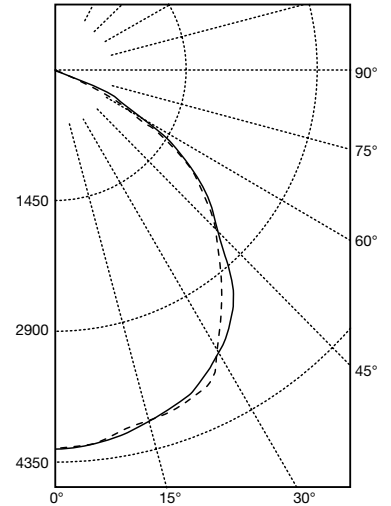

REPORT NUMBER: **MLEDN35P5BH** ①

Lamps: Mercmaster LED, Class I, Division 2, Polycarbonate Optic

Candela Distribution						
	0.0	22.5	45.0	67.5	90.0	Flux
0	4439	4439	4439	4439	4439	
5	4425	4417	4445	4432	4447	421
15	4356	4368	4410	4404	4418	1249
25	4356	4331	4394	4395	4357	20166
35	3912	3930	4045	4107	3826	2440
45	2929	2883	2866	2874	2929	2248
55	2277	2256	2296	2438	2394	2085
65	1105	893	843	957	825	927
75	20	25	22	26	22	38
85	2	2	2	4	3	4
90	1	1	1	2	1	

Zonal Lumen Summary		
Zone	Lumens	% Fixture
0-30	3686	32.3
0-40	6126	53.6
0-60	10460	91.5
0-90	11428	100.0

CIE Type – Direct	
Plane	Spacing Criteria
0-Deg	90-Deg
1.4	1.4

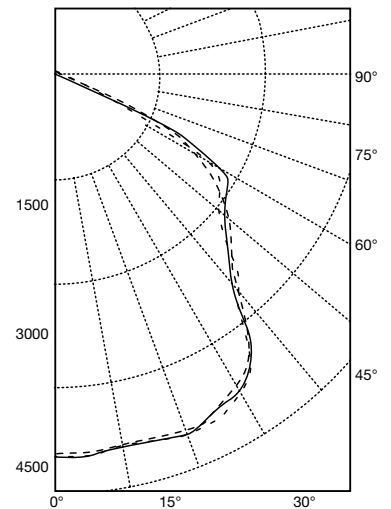

① Lamp type is not certified for use in ATEX/IEC governed locations.

Mercmaster™ LED Series Luminaires

Enclosed and Gasketed Fixtures

NEC/CEC:

Class I, Division 2, Groups A, B, C, D
 Class I, Zone 2, AEx nA IIC
 Class II, Division 1, Group E, F, G
 Class II, Division 2, Group F, G
 Class III

NEC/CEC:

Type 3R, 4, 4X
 IP66/67
 Simultaneous Exposure
 Suitable for Use in Wet Locations
 Marine Outside Type (Salt Water)

ATEX/IECEX:

Zone 2 and 22
 II 2 GD
 IP66/67

Photometric Data – DATA SHOWN IS ABSOLUTE

REPORT NUMBER: **MLEDN40P5BU**

Lamps: Mercmaster LED, Class I, Division 2, Polycarbonate Optic

Candela Distribution

	0.0	22.5	45.0	67.5	90.0	Flux
0	4958	4958	4958	4958	4958	
5	4976	4983	4949	4956	4941	472
15	4943	4934	4907	4921	4913	1400
25	4884	4920	4869	4900	4980	2263
35	4466	4590	4430	4410	4468	2738
45	3215	3213	3269	3286	3160	2525
55	2592	2635	2578	2612	2617	2330
65	833	1145	1070	1020	922	1067
75	30	32	29	33	32	55
85	40	5	3	3	3	5
90	1	2	1	1	1	

Zonal Lumen Summary

Zone	Lumens	% Fixture
0-30	4135	32.2
0-40	6873	53.5
0-60	11728	91.2
0-90	12855	100.0

CIE Type – Direct

Plane	Spacing Criteria
0-Deg	90-Deg
1.4	1.4

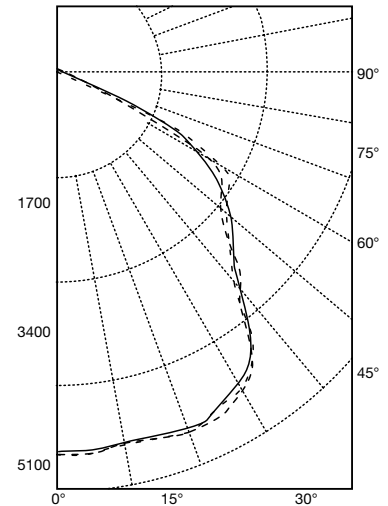

Appleton

LED/AREA: NEC/CEC, ATEX/IECEX ENCLOSED AND GASKETED

Mercmaster™ LED Low Profile Luminaires

Enclosed and Gasketed Fixtures

NEC/CEC:

Class I, Division 2, Groups A, B, C, D
Class I, Zone 2, Group IIC
Class II, Division 1, Groups E, F, G ①
Class II, Division 2, Groups F, G
Class III

NEC/CEC:

Type 3R, 4, 4X
IP66
Simultaneous Exposure
Suitable for Use in Wet Locations
Marine Outside Type (Salt Water) For USA ONLY ※

Applications

- Enclosed and gasketed fixtures suitable for use in:
 - A wide range of industrial, chemical processing and other areas where flammable gases and vapors are present
 - Marine and wet locations
 - Areas of low clearance, low ceiling heights or where fixture weights must be minimized
- Typical applications include:
 - Pulp and paper mills
 - Processing plants
 - Chemical plants
 - Petrochemical facilities
 - Oil refineries
 - Drilling rigs
 - Foundries
 - Waste and sewage treatment
 - Mining
 - Steel mills

Features

- Compact light weight low profile design is suited for low mounting heights.
- Six standard mounting hood designs allow for mounting in any location. Uses same mounting hoods as Mercmaster III.
- Customize to the application requirements with four different globe options: clear and diffused polycarbonate, clear glass, or prismatic glass refractor.
- Three light output levels for retrofit of HID fixtures up to 150 W.
- Hinge has high lip for added safety during installation and servicing. Hinge and bolt construction assures 360° compression at all points on fixture housing gasket for positive sealing. Swing away design of captive bolt and nut simplifies servicing.
- Operating ambient: -40 °C to 55 °C (-40 °F to +131 °F).
- Standard screw-type terminal block can accept UL/CSA 24-8 AWG wire.
- Standard NPT threads.

Options

- Glass globe guard is stainless steel wire. Glass refractor guard is die cast aluminum with gray epoxy powder coating to match fixtures.
- All Mercmaster mounting hoods have provision for fusing; add suffix -F at the end of the catalog number. ②
- Photocontrols are available with all except ceiling and pendant cone mounting hoods, and are configured to your operating voltage.

Standard Materials

- Mounting hoods and bodies: cast copperfree (4/10 of 1% max.) aluminum
- All hardware and catch assemblies: stainless steel
- Globe: polycarbonate or glass
- Refractor: heat-resistant prismatic glass
- Glass globe guard: stainless steel wire
- Glass refractor guard: die cast aluminum
- 30° angle reflectors : fiberglass reinforced white polyester

① Clear and diffused polycarbonate globes are not rated for Class II, Division I environments.

② Fusing only permitted for ULus rating.

※ Use of fuse voids Marine Outside Type (Salt Water) rating.



Standard Finishes

- Mounting hoods, bodies and glass refractor guard: gray epoxy powder coat finish, electrostatically applied for complete uniform protection

NEC/CEC Certifications and Compliances

- UL Standard: UL 50; UL 844, UL 1598, UL 1598A, UL 8750
- CSA Standard: C22.2 No 0; C22.2 No. 0.4; C22.2 No. 0.5; C22.2 No. 94; C22.2 No. 60529; C22.2 No. 137; C22.2 No. 250.0
- ANSI/IEC Standard: 60529
- cULus Listed: E10444
- DLC Qualified Products Listed

Related Products

- NEC, Class I, Division 2 photocells for classified use are available, see *PCD2 Series*.
 - Mounting hoods with photocontrols are not rated IP66, Type 4X or Marine Outside Type (Salt Water), or rated Class II.

DesignLights™ Consortium

- All Mercmaster™ LED Low Profile luminaires are listed and meet Design Lights Consortium performance standards.

Mercmaster™ LED Low Profile Luminaires

Enclosed and Gasketed Fixtures

NEC/CEC:

Class I, Division 2, Groups A, B, C, D
Class I, Zone 2, Group IIC
Class II, Division 1, Groups E, F, G ①
Class II, Division 2, Groups F, G
Class III

NEC/CEC:

Type 3R, 4, 4X
IP66
Simultaneous Exposure
Suitable for Use in Wet Locations
Marine Outside Type (Salt Water) For USA ONLY ⌘

Illustrated Features

Heatsink

Reliable heat transfer via the cast, epoxy powder coat aluminum body. Provides maximum heat dissipation from the LED assembly to the outside environment.



Driver Assembly

Utilizing non-sparking components avoiding the ignition of gases or vapors that may be present.



LED Chamber

Protected by polycarbonate or glass lens, allows for easy maintenance access.



Terminal Blocks

A seven-point terminal block is provided to facilitate wiring. Terminal block accommodates wire size ranging from 24-8 AWG.



Cooler Operating Cone Hood

Larger sloped surface sheds dusts, dirt and combustible fibers providing better heat dissipation.

Fuses (optional)

Two screws secure fuse kit to mounting boss in any Mercmaster mounting hood. Fuse included. *Note: Fusing only permitted for ULus rating. (Use of fuse voids Marine Outside Type (salt water) rating).*

Photocell (optional)

Available for all fixtures except cone and ceiling mount. Provides continuous ON-OFF dusk-to-dawn control. *Note: Fixtures with PCD2 photocontrols are not rated IP66, Type 4X, Marine Outside Type (Salt Water), or Class II.*

Prismatic Refractors

Heat-resistant refractor threads directly into fixture housing and seal against a high-temperature silicone rubber gasket.



Epoxy Finish

Fixture housing, hoods and guards are copperfree aluminum with epoxy powder coat finish.

Electrical Protection

Ground wire provided to bond mounting hood to fixture housing.

"Safety" High Hinge

Extra-high hinge provides additional protection against accidental fixture housing disengagement during installation or maintenance.

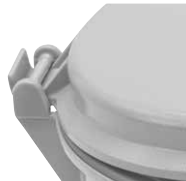

Mounting Hood and Globe Gaskets

Silicone rubber gaskets seal out moisture, dirt and dust. Stays flexible, withstands high temperatures. Closure design assures uniform gasket compression.

Stainless Steel Latch Assembly

Captive, stainless steel latch assembly bolt and nut closes securely, resists attack of corrosive atmospheres. Swing-away design simplifies servicing.



Reflectors

Reflectors are thick, tough fiberglass reinforced white polyester. Quickly attach with furnished stainless steel screws.



① Clear and diffused polycarbonate globes are not rated for Class II, Division I environments.

⌘ Use of fuse voids Marine Outside Type (Salt Water) rating.

Mercmaster™ LED Low Profile Luminaires

Enclosed and Gasketed Fixtures

NEC/CEC:

Class I, Division 2, Groups A, B, C, D
 Class I, Zone 2, Group IIC
 Class II, Division 1, Groups E, F, G ①
 Class II, Division 2, Groups F, G
 Class III

NEC/CEC:

Type 3R, 4, 4X
 IP66
 Simultaneous Exposure
 Suitable for Use in Wet Locations
 Marine Outside Type (Salt Water) For USA ONLY ❸

Mercmaster LED Low Profile Family Tree

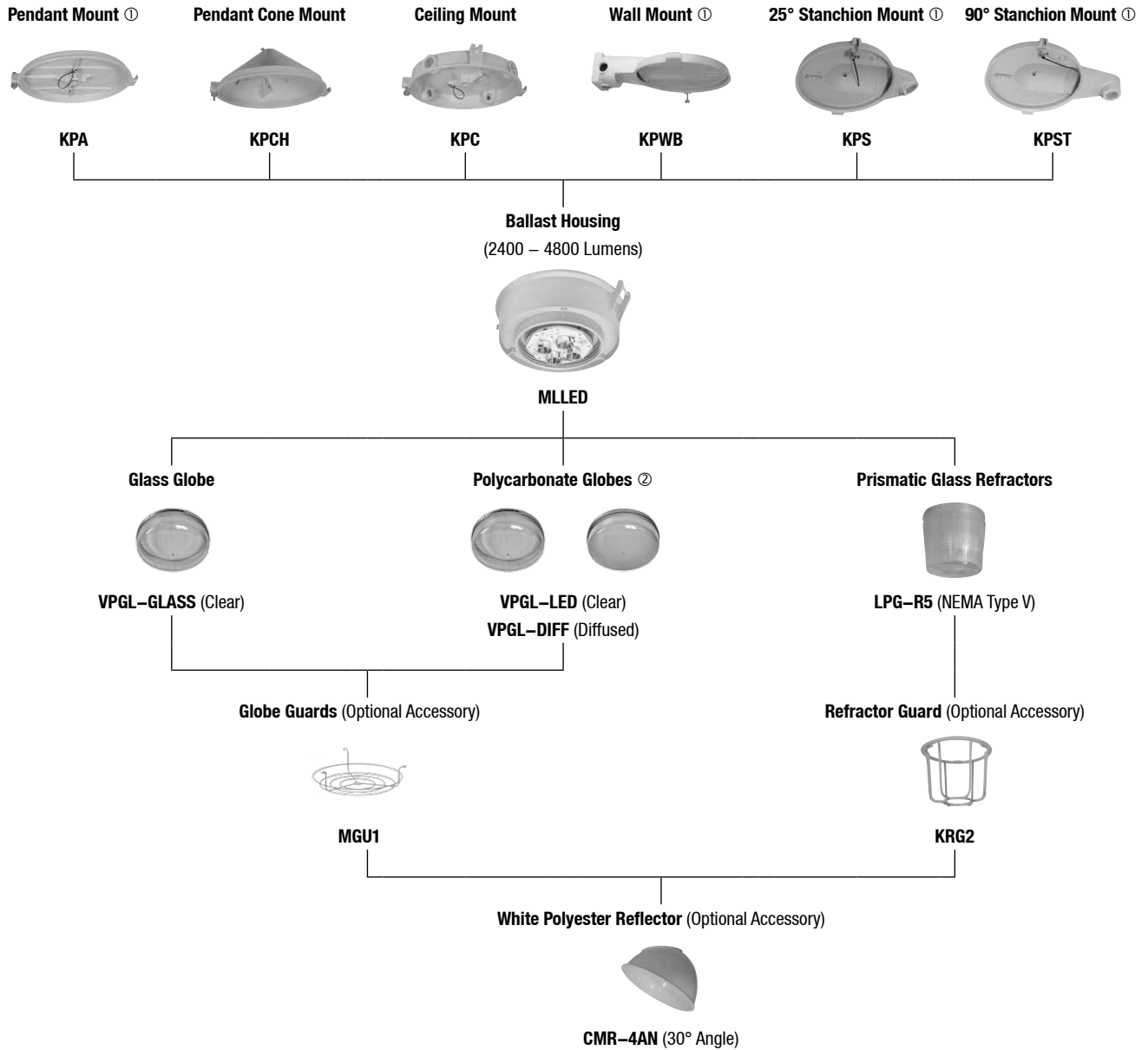

① Mounting hood with a 120 V or 208-277 V factory installed photocell is available.

② Polycarbonate globes are not Class II, Division 1.

Mercmaster™ LED Low Profile Luminaires

Enclosed and Gasketed Fixtures

NEC/CEC:
 Class I, Division 2, Groups A, B, C, D
 Class I, Zone 2, Group IIC
 Class II, Division 1, Groups E, F, G ①
 Class II, Division 2, Groups F, G
 Class III

NEC/CEC:
 Type 3R, 4, 4X
 IP66
 Simultaneous Exposure
 Suitable for Use in Wet Locations
 Marine Outside Type (Salt Water) For USA ONLY ⌘

Order using catalog numbering guides below or select catalog number from tables on following pages.

Catalog Numbering Guide For Hazardous Locations:

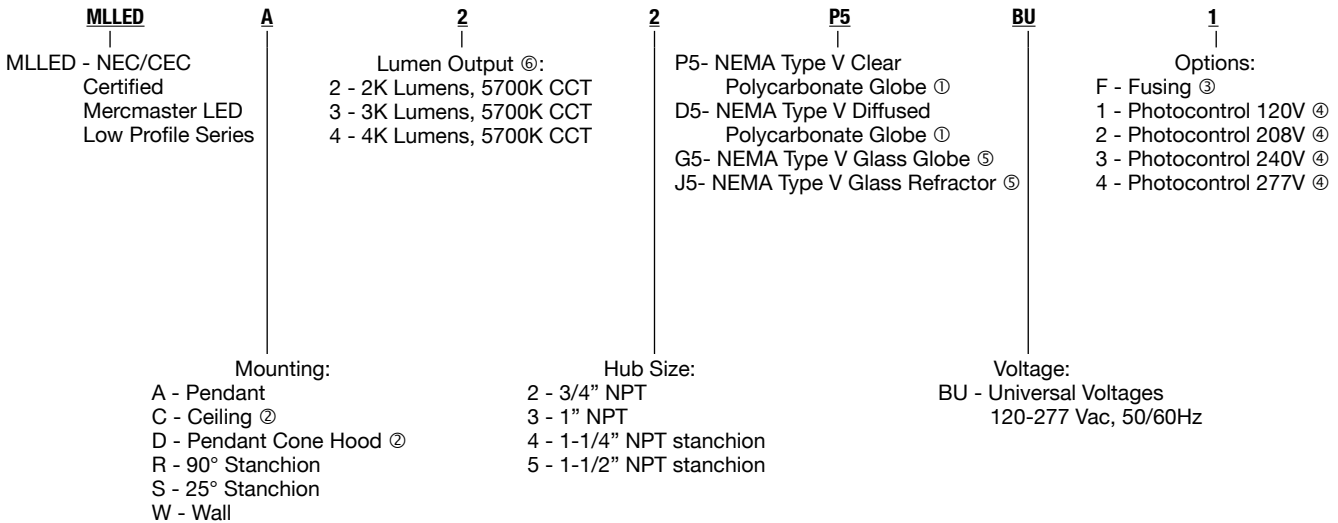

Appleton

LED/AREA: NEC/CEC, ATEX/IECEx ENCLOSED AND GASKETED

① Clear and diffused polycarbonate globes are not rated for Class II, Division I environments.
 ② Ceiling and pendant cone hood mounted luminaires are not designed to use the PCD2 photocontrol. Ceiling mounts must use an FS/FD box with a photocontrol. Contact your local sales representative for more information.
 ③ Fusing only permitted for ULus rating.
 ④ Luminaires with photocontrol are not rated IP66, Marine Outside Type (Salt Water), or Class II.
 ⑤ Guards for the glass refractors and globes are ordered separately. See the Accessories for more information.
 ⑥ For specific lumen output information, see Lamp Comparison Chart.
 ⌘ Use of fuse voids Marine Outside Type (Salt Water) rating.



Mercmaster™ LED Low Profile Luminaires

Enclosed and Gasketed Fixtures

NEC/CEC:
 Class I, Division 2, Groups A, B, C, D
 Class I, Zone 2, Group IIC
 Class II, Division 1, Groups E, F, G ①
 Class II, Division 2, Groups F, G
 Class III

NEC/CEC:
 Type 3R, 4, 4X
 IP66
 Simultaneous Exposure
 Suitable for Use in Wet Locations
 Marine Outside Type (Salt Water) For USA ONLY ⌘

Technical Data

Lamp		Ambient Temperature °C (°F)	Supply Wire Temperature °C (°F)	NEC/CEC				Gas/Dust Simultaneous ② Class I, Division 2/ Class II, Division 1	
Model	Type			Class I, Division 2 ②	Gas Groups	Class I, Zone 2,	Class II, Division 1 and 2 ③		Dust Groups
MLLED2 NEMA Type V	LED	40 (104)	60 (140)	T4	A, B, C, D	T4	T4A	E, F, G	T4A
		55 (131)	75 (167)	T4		T4	T4A		T4A
MLLED3 NEMA Type V	LED	40 (104)	60 (140)	T4	A, B, C, D	T4	T4A	E, F, G	T4A
		55 (131)	75 (167)	T4		T4	T4A		T4A
MLLED4 NEMA Type V	LED	40 (104)	60 (140)	T4	A, B, C, D	T4	T4A	E, F, G	T4A
		55 (131)	75 (167)	T4		T4	T4A		T4A

“T” Numbers Represent the Maximum Internal Temperature ② or Maximum Surface Temperature ③

“T” #	NEC/CEC															
	T1	350	325	T2	T2A	T2B	T2C	T2D	T3	T3A	T3B	T3C	T4	T4A	T5	T6
Temp. Range °C (°F)	351-450 (664-842)	326-350 (619-662)	301-325 (574-617)	281-300 (538-572)	261-280 (502-536)	231-260 (448-500)	216-230 (421-446)	201-215 (394-419)	181-200 (358-392)	166-180 (331-356)	161-165 (322-329)	136-160 (277-320)	121-135 (250-275)	101-120 (214-248)	86-100 (187-212)	85 (185)

Lamp Comparison Chart

Model	Line Current Amps	Input Power	Power Factor	THD	Lumens ④									
					Polycarbonate Clear Globe ①	Polycarbonate Diffused Globe ①	Glass Clear Globe	Type V Prismatic Glass Refractor	CRI	Lamp Life (Hours)	Color Temp CCT	Equivalent HID Luminaire		
NEMA Type V MLLED2	.21 @120V	26	> .97	< 20%	2400	2300	2500	2200	>70	60,000+	5700K	70 W		
	.10 @277V	26												
MLLED3	.29 @120V	35	> .97	< 20%	3400	3300	3600	3100	>70	60,000+	5700K	100 W		
	.13 @277V	34												
MLLED4	.41 @120V	48	> .88	< 20%	4800	4600	5000	4300	>70	60,000+	5700K	150 W		
	.20 @277V	48												

Surge Protection Common/Differential Mode:
 100kHz Ring Wave (w/t 30Ω): 6 KV
 1.2/50 μs Combination Wave (w/t 2Ω): MLLED2,
 MLLED3 4 KV; MLLED4 3 KV

① Clear and diffused polycarbonate globes are not rated for Class II, Division I environments
 ② T numbers represent the maximum internal temperature for Class I, Division 2 and Class I, Zone 2 locations designated by the NEC.
 ③ T numbers represent the maximum surface temperature under a dust blanket for Class II, Division 1 as designated by the NEC.
 ④ All lumen values are typical (tolerance +/- 10%).
 ⌘ Use of fuse voids Marine Outside Type (Salt Water) rating

Mercmaster™ LED Low Profile Luminaires



Enclosed and Gasketed Fixtures

NEC/CEC:

Class I, Division 2, Groups A, B, C, D
 Class I, Zone 2, Group IIC
 Class II, Division 1, Groups E, F, G ①
 Class II, Division 2, Groups F, G
 Class III

NEC/CEC:

Type 3R, 4, 4X
 IP66
 Simultaneous Exposure
 Suitable for Use in Wet Locations
 Marine Outside Type (Salt Water) For USA ONLY ⌘

	Hub Size	Lumen Level	With Type V Polycarbonate Globe ①②	With Type V Polycarbonate Diffused Globe ①②	Glass Globe ②③	With Type V Glass Refractor ②③
Pendant — One Hub						
	3/4	2K	MLLEDA22P5	MLLEDA22D5	MLLEDA22G5	MLLEDA22J5
	3/4	3K	MLLEDA32P5	MLLEDA32D5	MLLEDA32G5	MLLEDA32J5
	3/4	4K	MLLEDA42P5	MLLEDA42D5	MLLEDA42G5	MLLEDA42J5
	1	2K	MLLEDA23P5	MLLEDA23D5	MLLEDA23G5	MLLEDA23J5
	1	3K	MLLEDA33P5	MLLEDA33D5	MLLEDA33G5	MLLEDA33J5
	1	4K	MLLEDA43P5	MLLEDA43D5	MLLEDA43G5	MLLEDA43J5
Ceiling — Five Hubs, Four Close-up Plugs						
	3/4	2K	MLLEDC22P5	MLLEDC22D5	MLLEDC22G5	MLLEDC22J5
	3/4	3K	MLLEDC32P5	MLLEDC32D5	MLLEDC32G5	MLLEDC32J5
	3/4	4K	MLLEDC42P5	MLLEDC42D5	MLLEDC42G5	MLLEDC42J5
	1	2K	MLLEDC23P5	MLLEDC23D5	MLLEDC23G5	MLLEDC23J5
	1	3K	MLLEDC33P5	MLLEDC33D5	MLLEDC33G5	MLLEDC33J5
	1	4K	MLLEDC43P5	MLLEDC43D5	MLLEDC43G5	MLLEDC43J5
Pendant Cone — One Hub, Rigid Mounting						
	3/4	2K	MLLEDD22P5	MLLEDD22D5	MLLEDD22G5	MLLEDD22J5
	3/4	3K	MLLEDD32P5	MLLEDD32D5	MLLEDD32G5	MLLEDD32J5
	3/4	4K	MLLEDD42P5	MLLEDD42D5	MLLEDD42G5	MLLEDD42J5
	1	2K	MLLEDD23P5	MLLEDD23D5	MLLEDD23G5	MLLEDD23J5
	1	3K	MLLEDD33P5	MLLEDD33D5	MLLEDD33G5	MLLEDD33J5
	1	4K	MLLEDD43P5	MLLEDD43D5	MLLEDD43G5	MLLEDD43J5

① Clear and diffused polycarbonate globes are not rated for Class II, Division I environments

② For optional fusing, add suffix -F to the end of the catalog number. Fusing only permitted for ULus rating.

③ Guards are available for fixtures with glass globe or refractor. See following pages for accessory ordering information.

⌘ Use of fuse voids Marine Outside Type (Salt Water) rating.

Mercmaster™ LED Low Profile Luminaires



Enclosed and Gasketed Fixtures

NEC/CEC:

Class I, Division 2, Groups A, B, C, D
 Class I, Zone 2, Group IIC
 Class II, Division 1, Groups E, F, G ①
 Class II, Division 2, Groups F, G
 Class III

NEC/CEC:

Type 3R, 4, 4X
 IP66
 Simultaneous Exposure
 Suitable for Use in Wet Locations
 Marine Outside Type (Salt Water) For USA ONLY ⌘

	Hub Size	Lumen Level	With Type V Polycarbonate Globe ①②	With Type V Polycarbonate Diffused Globe ①②	Glass Globe ②③	With Type V Glass Refractor ②③
90° Stanchion — One hub						
	1 - 1/4	2K	MLLEDR24P5	MLLEDR24D5	MLLEDR24G5	MLLEDR24J5
	1 - 1/4	3K	MLLEDR34P5	MLLEDR34D5	MLLEDR34G5	MLLEDR34J5
	1 - 1/4	4K	MLLEDR44P5	MLLEDR44D5	MLLEDR44G5	MLLEDR44J5
	1 - 1/2	2K	MLLEDR25P5	MLLEDR25D5	MLLEDR25G5	MLLEDR25J5
	1 - 1/2	3K	MLLEDR35P5	MLLEDR35D5	MLLEDR35G5	MLLEDR35J5
	1 - 1/2	4K	MLLEDR45P5	MLLEDR45D5	MLLEDR45G5	MLLEDR45J5
25° Stanchion — One hub						
	1 - 1/4	2K	MLLEDS24P5	MLLEDS24D5	MLLEDS24G5	MLLEDS24J5
	1 - 1/4	3K	MLLEDS34P5	MLLEDS34D5	MLLEDS34G5	MLLEDS34J5
	1 - 1/4	4K	MLLEDS44P5	MLLEDS44D5	MLLEDS44G5	MLLEDS44J5
	1 - 1/2	2K	MLLEDS25P5	MLLEDS25D5	MLLEDS25G5	MLLEDS25J5
	1 - 1/2	3K	MLLEDS35P5	MLLEDS35D5	MLLEDS35G5	MLLEDS35J5
	1 - 1/2	4K	MLLEDS45P5	MLLEDS45D5	MLLEDS45G5	MLLEDS45J5
Wall — Five hubs, Four Close-Up Plugs						
	3/4	2K	MLLEDW22P5	MLLEDW22D5	MLLEDW22G5	MLLEDW22J5
	3/4	3K	MLLEDW32P5	MLLEDW32D5	MLLEDW32G5	MLLEDW32J5
	3/4	4K	MLLEDW42P5	MLLEDW42D5	MLLEDW42G5	MLLEDW42J5
	1	2K	MLLEDW23P5	MLLEDW23D5	MLLEDW23G5	MLLEDW23J5
	1	3K	MLLEDW33P5	MLLEDW33D5	MLLEDW33G5	MLLEDW33J5
	1	4K	MLLEDW43P5	MLLEDW43D5	MLLEDW43G5	MLLEDW43J5

① Clear and diffused polycarbonate globes are not rated for Class II, Division I environments

② For optional fusing, add suffix -F to the end of the catalog number. Fusing only permitted for ULus rating.

③ Guards are available for fixtures with glass globe or refractor. See following pages for accessory ordering information.

⌘ Use of fuse voids Marine Outside Type (Salt Water) rating.

Mercmaster™ LED Low Profile Luminaires

Enclosed and Gasketed Fixtures

NEC/CEC:
 Class I, Division 2, Groups A, B, C, D
 Class I, Zone 2, Group IIC
 Class II, Division 1, Groups E, F, G ①
 Class II, Division 2, Groups F, G
 Class III







NEC/CEC:
 Type 3R, 4, 4X
 IP66
 Simultaneous Exposure
 Suitable for Use in Wet Locations
 Marine Outside Type (Salt Water) For USA ONLY ⌘

Fixture Unit — Ballast Body and Globe or Refractor



Catalog Number ②							
Lumen Level	LED Wattage	Light Level Equivalent	NEMA Type	For Polycarbonate Globe ①	For Polycarbonate Diffused Globe ①	Glass Globe ③	For Refractor ③
NEC/CEC Certified Fixture Housing - For Hazardous Locations							
2K	26	70W HPS	Type V	MLLED2P5BU	MLLED2D5BU	MLLED2G5BU	MLLED2J5BU
3K	35	100W HPS	Type V	MLLED3P5BU	MLLED3D5BU	MLLED3G5BU	MLLED3J5BU
4K	48	150W HPS	Type V	MLLED4P5BU	MLLED4D5BU	MLLED4G5BU	MLLED4J5BU

Mounting Hoods

	Description	Hub Size	Catalog Number
Pendant	 One Hub	3/4	KPA-75
		1	KPA-100
Pendant Cone	 One Hub, Rigid Mounting	3/4	KPCH-75
		1	KPCH-100
Ceiling	 Five Hubs, Four Close-Up Plugs	3/4	KPC-75
		1	KPC-100
Wall	 Five Hubs, Four Close-Up Plugs	3/4	KPWB-75
		1	KPWB-100
25° Stanchion	 One Hub	1-1/4	KPS-125
		1-1/2	KPS-150
90° Stanchion	 One Hub	1-1/4	KPST-125
		1-1/2	KPST-150

① Clear and diffused polycarbonate globes are not rated for Class II, Division I environments

② BU - Universal Voltages 120-277 Vac, 50/60Hz

③ Guards are available for fixtures with glass globe or refractor. See following pages for accessory ordering information.

⌘ Use of fuse voids Marine Outside Type (Salt Water) rating.

Mercmaster™ LED Low Profile Luminaires

Enclosed and Gasketed Fixtures





NEC/CEC:

Class I, Division 2, Groups A, B, C, D
 Class I, Zone 2, Group IIC
 Class II, Division 1, Groups E, F, G ①
 Class II, Division 2, Groups F, G
 Class III

NEC/CEC:

Type 3R, 4, 4X
 IP66
 Simultaneous Exposure
 Suitable for Use in Wet Locations
 Marine Outside Type (Salt Water) For USA ONLY ⌘

Replacement Parts

	Description	Catalog Number
Globes and Gaskets		
	Clear Globe (polycarbonate)	VPGL-LED
	Diffused Globe (polycarbonate)	VPGL-DIFF
	Glass Globe	VPGL-GLASS
	Globe Gasket — Silicone Rubber	KRF-GK
Light Distribution		Catalog Number
Closed Prismatic Glass Refractors — All Heat-Resistant		
 Glass Refractor	NEMA Type V	LPG-R5
Description		Catalog Number
LED Array		
MLLED2 Array assembly, Type V, 5700K		MLLED2A5W
MLLED3 Array assembly, Type V, 5700K		MLLED3A5W
MLLED4 Array assembly, Type V, 5700K		MLLED4A5W
Drivers		
120-277V Driver for MLLED2 and MLLED3		MLLEDBU
120-277V Driver for MLLED4		MLLEDBU4

① Clear and diffused polycarbonate globes are not rated for Class II, Division I environments
 ⌘ Use of fuse voids Marine Outside Type (Salt Water) rating.

Mercmaster™ LED Low Profile Luminaires

Enclosed and Gasketed Fixtures





NEC/CEC:

Class I, Division 2, Groups A, B, C, D
 Class I, Zone 2, Group IIC
 Class II, Division 1, Groups E, F, G ①
 Class II, Division 2, Groups F, G
 Class III

NEC/CEC:

Type 3R, 4, 4X
 IP66
 Simultaneous Exposure
 Suitable for Use in Wet Locations
 Marine Outside Type (Salt Water) For USA ONLY ⌘

Accessories

		Description	Catalog Number
White Polyester Reflectors			
		30° Angle	CMR-4AN
	30° Angle		
Guards			
		Glass Globe Guard	MGU1
	Glass Globe Guard		
		Refractor Guard	KRG2
	Refractor Guard		
Adapters			
		Adapter Assembly from V51 to MM III/LED Series	LPAD-1 ②

Appleton

LED/AREA: NEC/CEC, ATEX/IECEX ENCLOSED AND GASKETED

① Clear and diffused polycarbonate globes are not rated for Class II, Division I environments.

② LPAD-1 adapter is not UL certified for use with MLLLED luminaires.

⌘ Use of fuse voids Marine Outside Type (Salt Water) rating.

Mercmaster™ LED Low Profile Luminaires

Enclosed and Gasketed Fixtures

NEC/CEC:

Class I, Division 2, Groups A, B, C, D
 Class I, Zone 2, Group IIC
 Class II, Division 1, Groups E, F, G ①
 Class II, Division 2, Groups F, G
 Class III

NEC/CEC:

Type 3R, 4, 4X
 IP66
 Simultaneous Exposure
 Suitable for Use in Wet Locations
 Marine Outside Type (Salt Water) For USA ONLY ⌘

Dimensions in Millimeters (Inches)

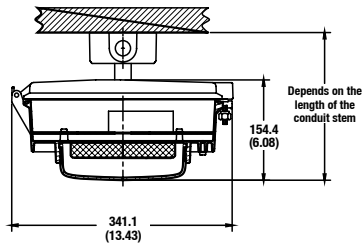

Pendant Mount

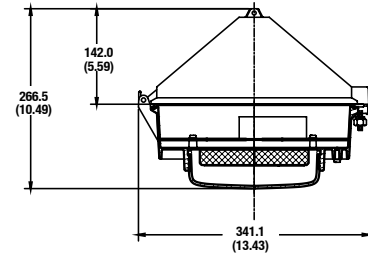

Pendant Cone Mount

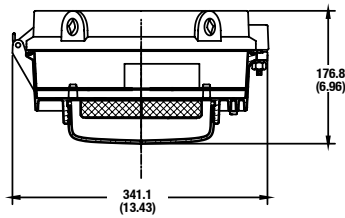

Ceiling Mount

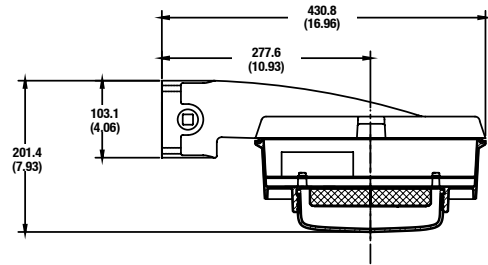

Wall Mount

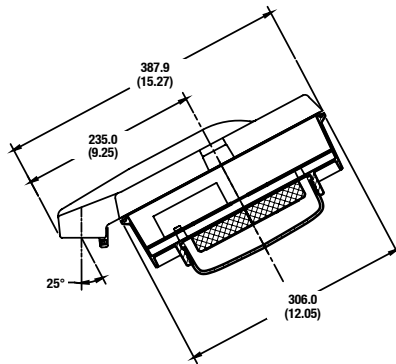

Angle Stanchion Mount

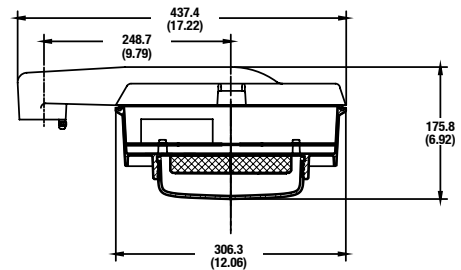

Stanchion Mount

① Clear and diffused polycarbonate globes are not rated for Class II, Division I environments.
 ⌘ Use of fuse voids Marine Outside Type (Salt Water) rating.

Mercmaster™ LED Low Profile Luminaires

Enclosed and Gasketed Fixtures

NEC/CEC:

Class I, Division 2, Groups A, B, C, D
 Class I, Zone 2, Group IIC
 Class II, Division 1, Groups E, F, G ①
 Class II, Division 2, Groups F, G
 Class III

NEC/CEC:

Type 3R, 4, 4X
 IP66
 Simultaneous Exposure
 Suitable for Use in Wet Locations
 Marine Outside Type (Salt Water) For USA ONLY ⌘

Dimensions With Polycarbonate Globe in Millimeters (Inches)

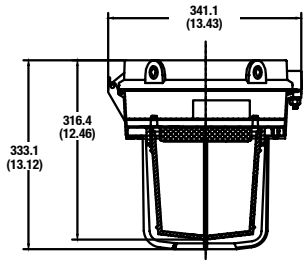

Ceiling Mount w/ Refractor and Guard

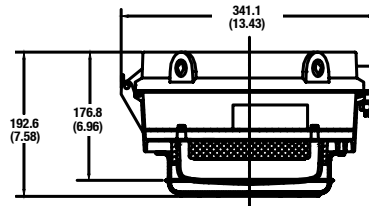

Ceiling Mount w/ Glass Globe and Guard

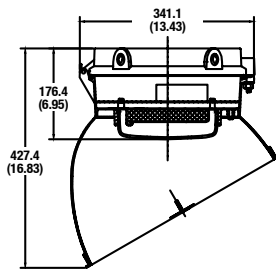

Ceiling Mount with Globe and 30° Reflector

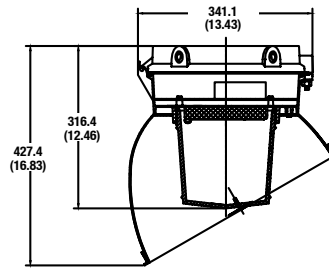

Ceiling Mount with Refractor and 30° Reflector

Mercmaster LED Low Profile Fixture and Mounting Hood Weights

Description	Weight kg (lb)
Fixture Unit (MLLED2/MLLED3)	4.1 (9.00)
Fixture Unit (MLLED4)	4.6 (10.1)
Pendant Mounting Hood	1.0 (2.25)
Pendant Cone Mounting Hood	1.1 (2.50)
Ceiling Mounting Hood	1.4 (3.00)
Wall Mounting Hood	1.8 (4.00)
25° Stanchion Mounting Hood	1.5 (3.25)
90° Stanchion Mounting Hood	1.7 (3.75)

① Clear and diffused polycarbonate globes are not rated for Class II, Division I environments.

⌘ Use of fuse voids Marine Outside Type (Salt Water) rating.

PCD2 Series Factory Sealed Hazardous Location Photocontrol ^①

For Use in Class I, Division 2, Groups A, B, C, D Locations

Maintains Class I, Division 2 rating for Mercmaster III, Mercmaster III Low Profile, Mercmaster III 50-250 and 400 Series Luminaires; Mercmaster LED Series.

NEC/CEC:
Class I, Division 2, Groups A, B, C, D
NEMA 4X

Applications

- Encapsulated photocontrol provides automatic dusk-to-dawn lighting control in Class I, Division 2 locations.
- Typical applications include walkways, security areas and any other outdoor lighting application.
- For use with all Mercmaster LED series.
- For remote mounting in FS Boxes.

- Available for 120, 208, 240, or 277 volts.
- 1000 V.A. Voltage/Ampere
- Minimum time delay: 15 seconds to eliminate nuisance tripping.
- Provided with (3) 18AWG stranded leads 152.4 mm (6.00 in) length.
- Will fit through standard 1/2" knockout.
- Supplied with locknut and gasket.

Features



- Factory sealed design eliminates the need for an explosionproof enclosure.
- One-piece molded GE Ultem 1000 translucent lens assembly, UL94V-0 compliant.
- Can be easily installed in the field.
- Solid state design for performance and reliability.

Materials

- Encapsulated with epoxy sealing compound
- FS Cover: aluminum

NEC/CEC Certifications and Compliances

- UL Standard: 1604 – Hazardous (Classified) Locations
- cULus Recognized

	Voltage Range	Max VA	Max Current Amps	Suffix Designation Catalog Number
Factory Installed Photocontrol — Not for ceiling or pendant cone				
<i>Add to fixture catalog after voltage; i.e.: MLLEDA32P5BU1.</i>				
	120 V, 50/60 Hz	1000	8.3 Amp	1
	208 V, 50/60 Hz	1000	4.8 Amp	2
	240 V, 50/60 Hz	1000	4.2 Amp	3
	277 V, 50/60 Hz	1000	3.6 Amp	4
Photocontrol, purchased separately				
	120 V, 50/60 Hz	1000	8.3 Amp	PC120D2
	208 V, 50/60 Hz	1000	4.8 Amp	
	240 V, 50/60 Hz	1000	4.2 Amp	PC247D2
	277 V, 50/60 Hz	1000	3.6 Amp	
Photocontrol in FS Cover for Use with FS/FD Box				
<i>Supplied with two stainless steel screws. For neoprene gasket, order catalog number FS-GKR-1N.</i>				
	120 V, 50/60 Hz	1000	8.3 Amp	FSKA-PC120D2
	208 V, 50/60 Hz	1000	4.8 Amp	
	240 V, 50/60 Hz	1000	4.2 Amp	FSKA-PC247D2
	277 V, 50/60 Hz	1000	3.6 Amp	

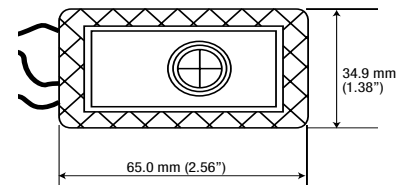
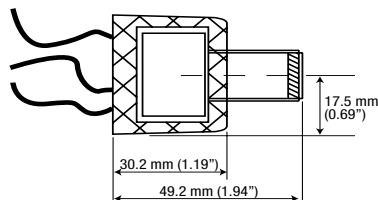
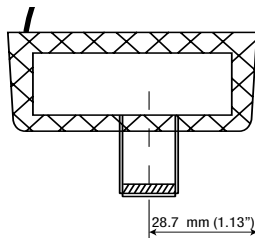

^① Fixtures with photocontrols are not rated IP66, Type 4X, marine outside type (salt water), or Class II.

Mercmaster™ LED Low Profile Luminaires

Enclosed and Gasketed Fixtures

NEC/CEC:

Class I, Division 2, Groups A, B, C, D
 Class I, Zone 2, Group IIC
 Class II, Division 1, Groups E, F, G ①
 Class II, Division 2, Groups F, G
 Class III

NEC/CEC:

Type 3R, 4, 4X
 IP66
 Simultaneous Exposure
 Suitable for Use in Wet Locations
 Marine Outside Type (Salt Water) For USA ONLY ⌘

Photometric Data — DATA SHOWN IS ABSOLUTE

MLLED2P5BU 2K Lumen 5700K CCT with Clear Polycarbonate Lens

Polar Candela Distribution

Isoillumination Plot

Zonal Lumens and Percentages at 25°C

Zone	Lumens	% Luminaire	Zone	Lumens	% Luminaire
0-30	852.7	35.4	0-10	86.5	3.6
0-40	1423	59.2	10-20	280.4	11.7
0-60	2368	98.5	20-30	485.8	20.2
60-90	37.0	1.5	30-40	570.3	23.7
0-90	2406	100.0	40-50	573.0	23.8
90-180	0.0	0.0	50-60	372.5	15.5
0-180	2406	100.0	60-70	27.9	1.2
			70-80	7.0	0.3
			80-90	2.1	0.1

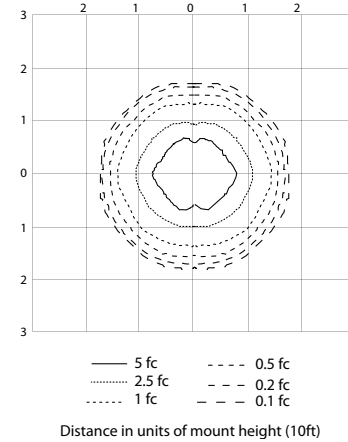
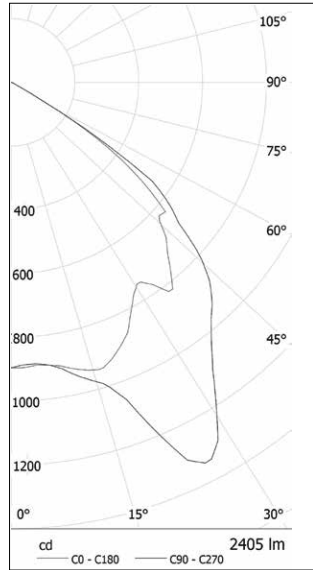

MLLED2D5BU 2K Lumen 5700K CCT with Diffused Polycarbonate Lens

Polar Candela Distribution

Isoillumination Plot

Zonal Lumens and Percentages at 25°C

Zone	Lumens	% Luminaire	Zone	Lumens	% Luminaire
0-30	788.1	34.3	0-10	85.9	3.7
0-40	1299	56.5	10-20	266.8	11.6
0-60	2092	90.9	20-30	435.4	18.9
60-90	194.5	8.5	30-40	510.6	22.2
0-90	2286	99.4	40-50	478.8	20.8
90-180	14.7	0.6	50-60	314.0	13.6
0-180	2301	100.0	60-70	130.7	5.7
			70-80	50.4	2.2
			80-90	13.4	0.6
			90-100	4.0	0.2
			100-110	9.5	0.4
			110-120	1.2	0.1

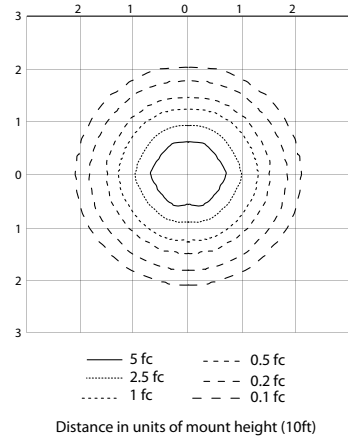
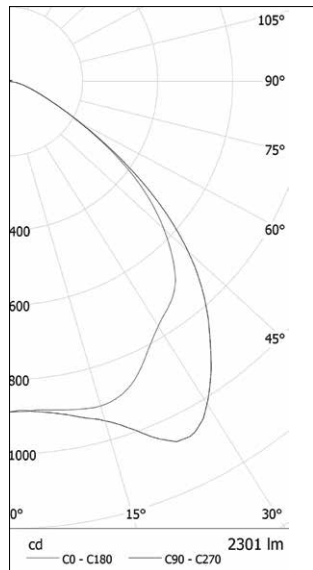

① Clear and diffused polycarbonate globes are not rated for Class II, Division I environments.
 ⌘ Use of fuse voids Marine Outside Type (Salt Water) rating.

Mercmaster™ LED Low Profile Luminaires

Enclosed and Gasketed Fixtures

NEC/CEC:

Class I, Division 2, Groups A, B, C, D
 Class I, Zone 2, Group IIC
 Class II, Division 1, Groups E, F, G ①
 Class II, Division 2, Groups F, G
 Class III

NEC/CEC:

Type 3R, 4, 4X
 IP66
 Simultaneous Exposure
 Suitable for Use in Wet Locations
 Marine Outside Type (Salt Water) For USA ONLY Ⓜ

Photometric Data – DATA SHOWN IS ABSOLUTE

MLLED2G5BU 2K Lumen 5700K CCT with Glass Globe

Zonal Lumens and Percentages at 25°C

Zone	Lumens	% Luminaire	Zone	Lumens	% Luminaire
0-30	896.4	35.5	0-10	90.7	3.6
0-40	1498	59.4	10-20	294.9	11.7
0-60	2490	98.7	20-30	510.7	20.2
60-90	33.4	1.3	30-40	601.9	23.9
0-90	2523	100.0	40-50	605.8	24.0
90-180	0.0	0.0	50-60	385.7	15.3
0-180	2523	100.0	60-70	26.1	1.0
			70-80	5.8	0.2
			80-90	1.4	0.1

Polar Candela Distribution

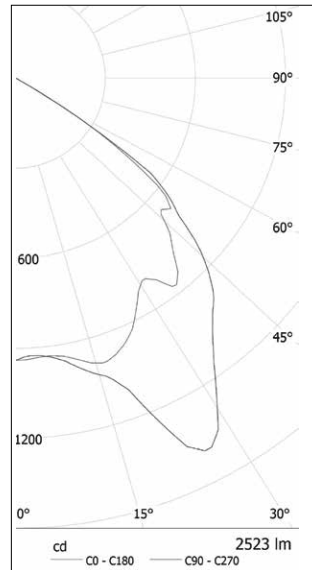

Isoillumination Plot

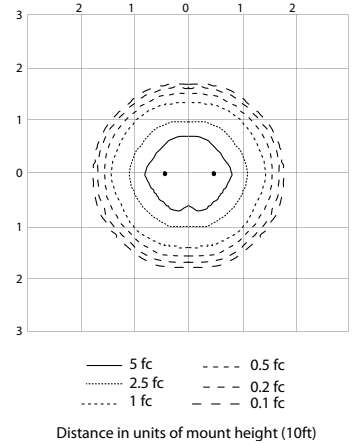

MLLED2J5BU 2K Lumen 5700K CCT with Glass Refractor

Zonal Lumens and Percentages at 25°C

Zone	Lumens	% Luminaire	Zone	Lumens	% Luminaire
0-30	421.8	19.5	0-10	42.6	2.0
0-40	758.5	35.1	10-20	137.9	6.4
0-60	1612	74.6	20-30	241.3	11.2
60-90	287.7	13.3	30-40	336.8	15.6
0-90	1900	87.9	40-50	440.2	20.4
90-180	261.4	12.1	50-60	413.6	19.1
0-180	2161	100.0	60-70	155.1	7.2
			70-80	79.1	3.7
			80-90	53.5	2.5
			90-100	42.3	2.0
			100-110	43.7	2.0
			110-120	53.9	2.5
			120-130	60.8	2.8
			130-140	42.9	2.0
			140-150	16.4	0.8
			150-160	1.4	0.1

Polar Candela Distribution

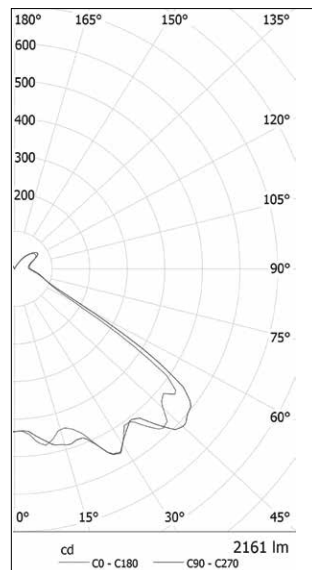

Isoillumination Plot

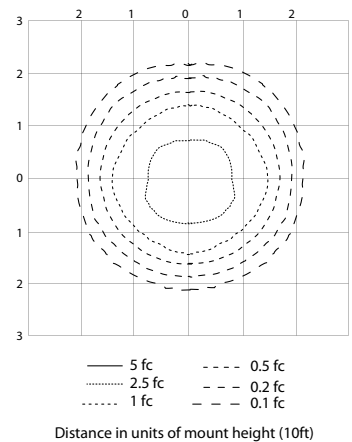

① Clear and diffused polycarbonate globes are not rated for Class II, Division I environments.
 Ⓜ Use of fuse voids Marine Outside Type (Salt Water) rating.

Mercmaster™ LED Low Profile Luminaires

Enclosed and Gasketed Fixtures

NEC/CEC:
 Class I, Division 2, Groups A, B, C, D
 Class I, Zone 2, Group IIC
 Class II, Division 1, Groups E, F, G ①
 Class II, Division 2, Groups F, G
 Class III

NEC/CEC:
 Type 3R, 4, 4X
 IP66
 Simultaneous Exposure
 Suitable for Use in Wet Locations
 Marine Outside Type (Salt Water) For USA ONLY ⌘

Photometric Data — DATA SHOWN IS ABSOLUTE

MLLED3P5BU 3K Lumen 5700K CCT with Clear Polycarbonate Lens

Zonal Lumens and Percentages at 25°C

Zone	Lumens	% Luminaire	Zone	Lumens	% Luminaire
0-30	1161	34.1	0-10	121.6	3.6
0-40	1992	58.5	10-20	378.1	11.1
0-60	3358	98.5	20-30	660.9	19.4
60-90	49.5	1.5	30-40	831.4	24.4
0-90	3408	100.0	40-50	837.7	24.6
90-180	0.0	0.0	50-60	528.5	15.5
0-180	3408	100.0	60-70	37.7	1.1
			70-80	9.2	0.3
			80-90	2.6	0.1

Polar Candela Distribution

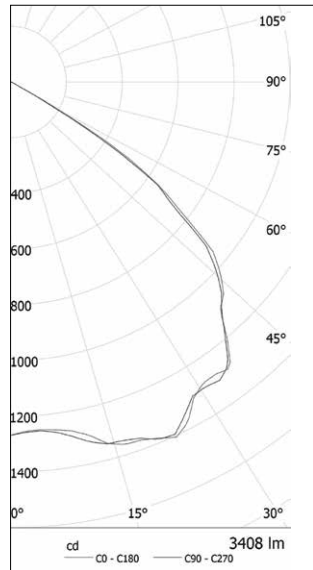

Isoillumination Plot

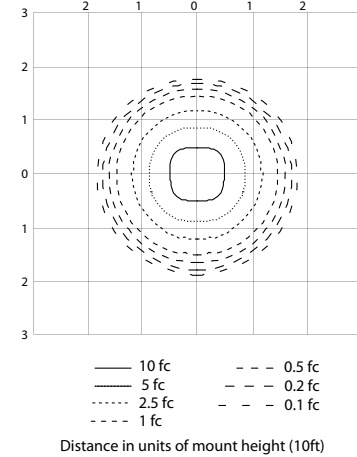

MLLED3D5BU 3K Lumen 5700K CCT with Diffused Polycarbonate Lens

Zonal Lumens and Percentages at 25°C

Zone	Lumens	% Luminaire	Zone	Lumens	% Luminaire
0-30	1090	33.2	0-10	120.5	3.7
0-40	1827	55.6	10-20	366.3	11.1
0-60	2980	90.6	20-30	603.4	18.4
60-90	283.7	8.6	30-40	736.6	22.4
0-90	3263	99.3	40-50	698.3	21.2
90-180	24.6	0.7	50-60	454.6	13.8
0-180	3288	100.0	60-70	188.8	5.7
			70-80	73.6	2.2
			80-90	21.3	0.6
			90-100	7.3	0.2
			100-110	14.8	0.4
			110-120	2.5	0.1

Polar Candela Distribution

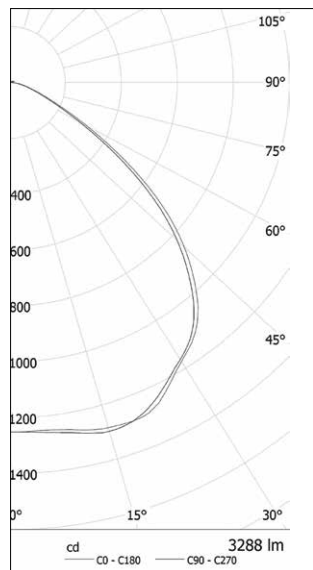

Isoillumination Plot

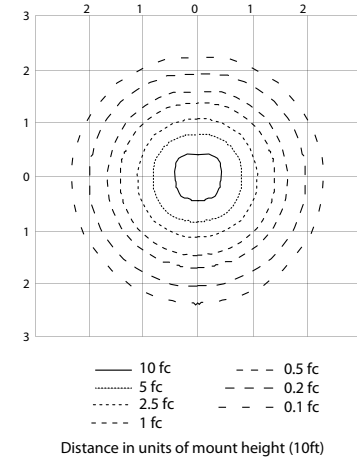

① Clear and diffused polycarbonate globes are not rated for Class II, Division I environments.
 ⌘ Use of fuse voids Marine Outside Type (Salt Water) rating.

Mercmaster™ LED Low Profile Luminaires

Enclosed and Gasketed Fixtures

NEC/CEC:

Class I, Division 2, Groups A, B, C, D
 Class I, Zone 2, Group IIC
 Class II, Division 1, Groups E, F, G ①
 Class II, Division 2, Groups F, G
 Class III

NEC/CEC:

Type 3R, 4, 4X
 IP66
 Simultaneous Exposure
 Suitable for Use in Wet Locations
 Marine Outside Type (Salt Water) For USA ONLY Ⓜ

Photometric Data – DATA SHOWN IS ABSOLUTE

MLLED3G5BU 3K Lumen 5700K CCT with Glass Globe

Zonal Lumens and Percentages at 25°C

Zone	Lumens	% Luminaire	Zone	Lumens	% Luminaire
0-30	1220	34.1	0-10	127.4	3.6
0-40	2095	58.6	10-20	397.2	11.1
0-60	3525	98.7	20-30	695.5	19.5
60-90	47.7	1.3	30-40	874.8	24.5
0-90	3573	100.0	40-50	880.9	24.7
90-180	0.0	0.0	50-60	549.3	15.4
0-180	3573	100.0	60-70	36.8	1.0
			70-80	8.5	0.2
			80-90	2.3	0.1

Polar Candela Distribution

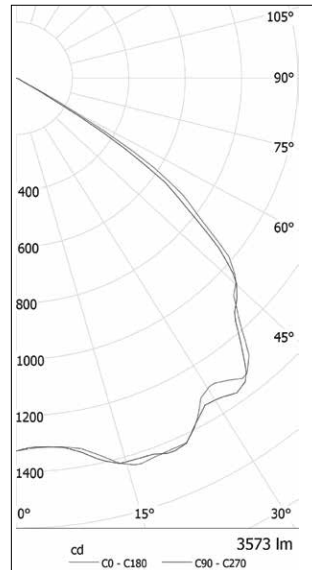

Isoillumination Plot

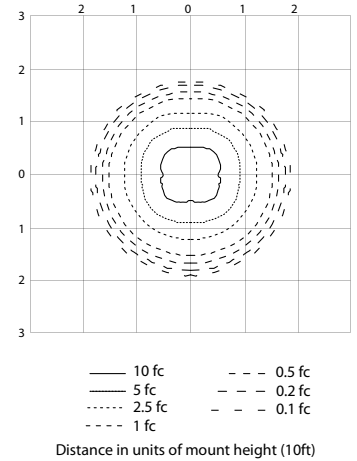

MLLED3J5BU 3K Lumen 5700K CCT with Glass Refractor

Zonal Lumens and Percentages at 25°C

Zone	Lumens	% Luminaire	Zone	Lumens	% Luminaire
0-30	593.6	19.3	0-10	59.9	1.9
0-40	1069	34.7	10-20	194.1	6.3
0-60	2292	74.4	20-30	339.6	11.0
60-90	417.3	13.5	30-40	475.6	15.4
0-90	2709	87.9	40-50	622.0	20.2
90-180	372.4	12.1	50-60	601.0	19.5
0-180	3082	100.0	60-70	227.5	7.4
			70-80	113.1	3.7
			80-90	76.7	2.5
			90-100	60.6	2.0
			100-110	62.7	2.0
			110-120	76.1	2.5
			120-130	84.4	2.8
			130-140	61.2	2.0
			140-150	24.1	0.8
			150-160	2.2	0.1

Polar Candela Distribution

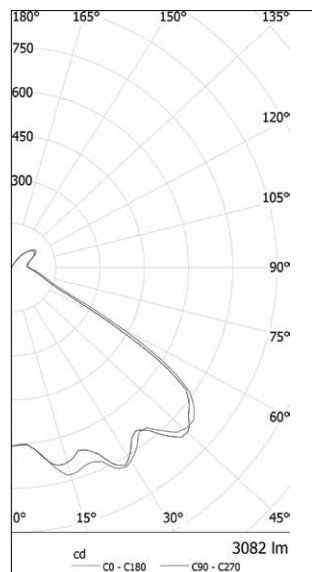

Isoillumination Plot

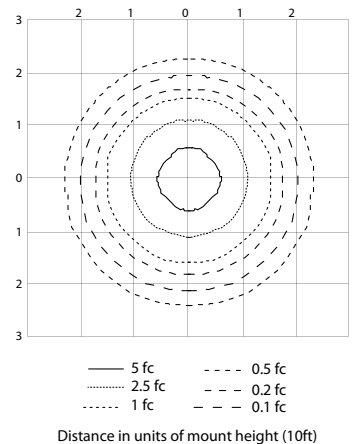

① Clear and diffused polycarbonate globes are not rated for Class II, Division I environments.
 Ⓜ Use of fuse voids Marine Outside Type (Salt Water) rating.

Mercmaster™ LED Low Profile Luminaires

Enclosed and Gasketed Fixtures

NEC/CEC:

Class I, Division 2, Groups A, B, C, D
 Class I, Zone 2, Group IIC
 Class II, Division 1, Groups E, F, G ①
 Class II, Division 2, Groups F, G
 Class III

NEC/CEC:

Type 3R, 4, 4X
 IP66
 Simultaneous Exposure
 Suitable for Use in Wet Locations
 Marine Outside Type (Salt Water) For USA ONLY ⌘

Photometric Data — DATA SHOWN IS ABSOLUTE

MLLED4P5BU 4K Lumen 5700K CCT with Clear Polycarbonate Lens

Polar Candela Distribution

Isoillumination Plot

Zonal Lumens and Percentages at 25°C

Zone	Lumens	% Luminaire	Zone	Lumens	% Luminaire
0-30	1676	34.9	0-10	171.9	3.6
0-40	2829	59.0	10-20	549.3	11.5
0-60	4705	98.1	20-30	954.3	19.9
60-90	89.7	1.9	30-40	1153	24.0
0-90	4795	100.0	40-50	1126	23.5
90-180	0.0	0.0	50-60	751.1	15.7
0-180	4795	100.0	60-70	63.9	1.3
			70-80	17.9	0.4
			80-90	7.8	0.2

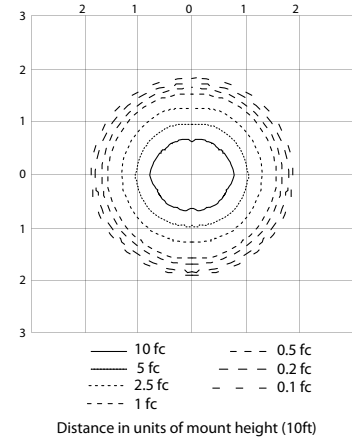
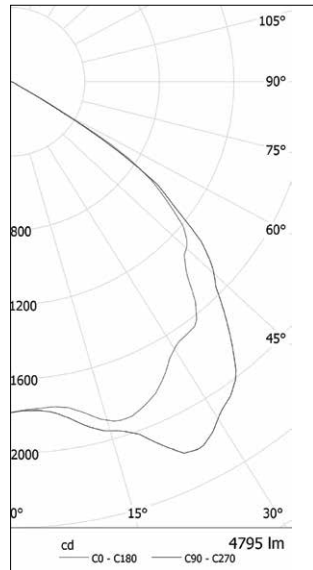

MLLED4D5BU 4K Lumen 5700K CCT with Diffused Polycarbonate Lens

Polar Candela Distribution

Isoillumination Plot

Zonal Lumens and Percentages at 25°C

Zone	Lumens	% Luminaire	Zone	Lumens	% Luminaire
0-30	1560	34.0	0-10	170.4	3.7
0-40	2583	56.2	10-20	526.5	11.5
0-60	4159	90.6	20-30	863.6	18.8
60-90	398.6	8.7	30-40	1022	22.3
0-90	4558	99.2	40-50	948.3	20.6
90-180	35.2	0.8	50-60	628.0	13.7
0-180	4593	100.0	60-70	266.2	5.8
			70-80	102.8	2.2
			80-90	29.6	0.6
			90-100	10.2	0.2
			100-110	21.6	0.5
			110-120	3.7	0.1

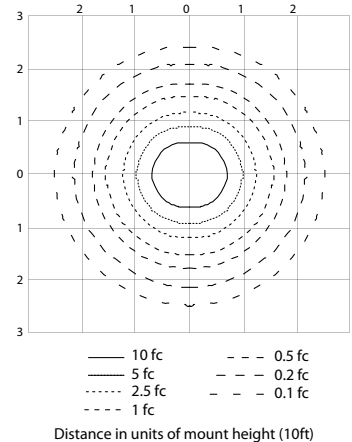
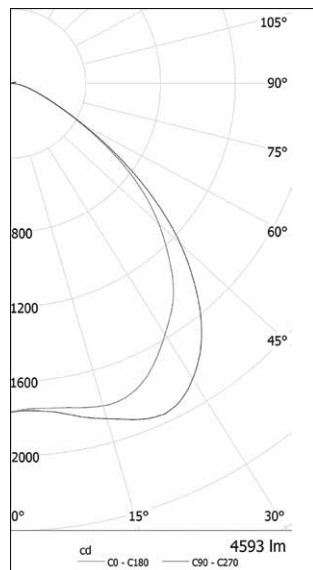

① Clear and diffused polycarbonate globes are not rated for Class II, Division I environments.
 ⌘ Use of fuse voids Marine Outside Type (Salt Water) rating.

Mercmaster™ LED Low Profile Luminaires

Enclosed and Gasketed Fixtures

NEC/CEC:

Class I, Division 2, Groups A, B, C, D
 Class I, Zone 2, Group IIC
 Class II, Division 1, Groups E, F, G ①
 Class II, Division 2, Groups F, G
 Class III

NEC/CEC:

Type 3R, 4, 4X
 IP66
 Simultaneous Exposure
 Suitable for Use in Wet Locations
 Marine Outside Type (Salt Water) For USA ONLY ⌘

Photometric Data – DATA SHOWN IS ABSOLUTE

MLLED4G5BU 4K Lumen 5700K CCT with Glass Globe

Zonal Lumens and Percentages at 25°C

Zone	Lumens	% Luminaire	Zone	Lumens	% Luminaire
0-30	1748	35.1	0-10	178.5	3.6
0-40	2952	59.3	10-20	572.7	11.5
0-60	4906	98.6	20-30	997.0	20.0
60-90	71.5	1.4	30-40	1204	24.2
0-90	4977	100.0	40-50	1175	23.6
90-180	0.0	0.0	50-60	778.5	15.6
0-180	4977	100.0	60-70	57.6	1.2
			70-80	11.2	0.2
			80-90	2.6	0.1

Polar Candela Distribution

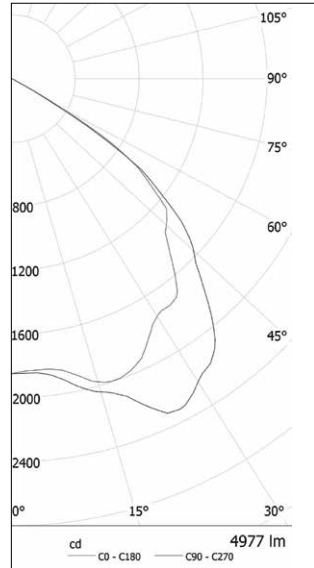

Isoillumination Plot

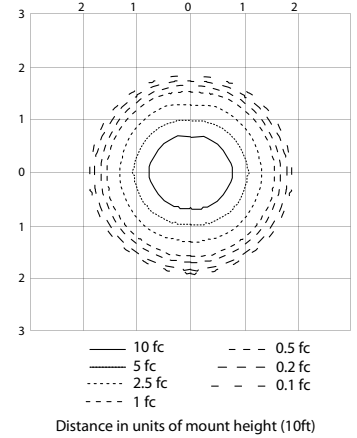

MLLED4J5BU 4K Lumen 5700K CCT with Glass Refractor

Zonal Lumens and Percentages at 25°C

Zone	Lumens	% Luminaire	Zone	Lumens	% Luminaire
0-30	836.3	19.5	0-10	84.6	2.0
0-40	1501	35.0	10-20	274.6	6.4
0-60	3199	74.7	20-30	477.1	11.1
60-90	571.9	13.4	30-40	664.8	15.5
0-90	3771	88.0	40-50	871.2	20.3
90-180	512.5	12.0	50-60	826.7	19.3
0-180	4283	100.0	60-70	308.3	7.2
			70-80	156.7	3.7
			80-90	106.9	2.5
			90-100	84.6	2.0
			100-110	87.9	2.1
			110-120	105.6	2.5
			120-130	115.7	2.7
			130-140	82.9	1.9
			140-150	32.6	0.8
			150-160	3.2	0.1

Polar Candela Distribution

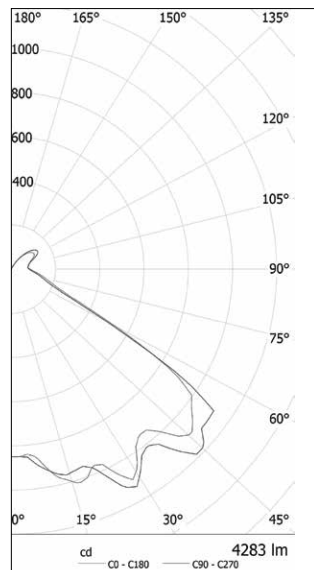

Isoillumination Plot

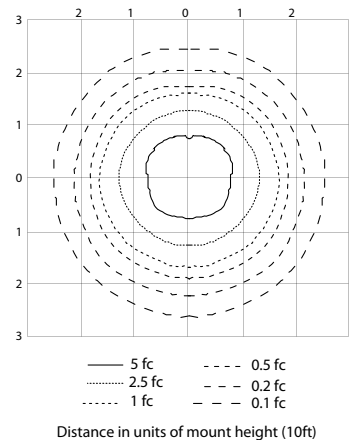

① Clear and diffused polycarbonate globes are not rated for Class II, Division I environments.
 ⌘ Use of fuse voids Marine Outside Type (Salt Water) rating.

Viamaster™ LED Series Luminaires

For NEC and CEC Governed Hazardous Locations

NEC/CEC:
Class I, Division 2, Groups A, B, C, D
Class I, Zone 2, Group IIC
Class II, Division 2, Groups F, G
Class III
Type 3R, 4, 4X

NEC/CEC:
Marine Outside Type- For USA Only ⌘
IP66/IP67

Applications

- For use in locations where:
 - Flammable gases, vapors and dusts are present
 - A high degree of corrosion resistance is required
 - Protection against dirt, water and moisture is necessary
- Typical applications include:
 - Oil refineries
 - Petrochemical facilities
 - Pulp and paper mills
 - Food processing plants
 - Waste and sewer treatment
 - Underground tunnels
 - General manufacturing facilities



Features

- 60,000+ hour LED life for years of maintenance free operation.
- Lightweight design, hinged cover with captive screws, and terminal block wiring for easy installation and maintenance.
- Standard screw-type terminal block can accept UL/CSA 26 to 10 AWG wire.
- Contemporary, low profile design suitable for tight spaces.
- Field replaceable LED driver and lens.
- Industry-leading thermal management for safe, reliable operation over wide temperature range.
- Full range of lumen outputs, with light distribution equivalent to Appleton's FV Series fluorescent fixtures
- Easy to retrofit in same mounting footprint as Appleton's FV Series fluorescent fixtures.
- 2 opposing 3/4" NPT hubs with adjacent terminal blocks for thru wiring. (1) 3/4" NPT close up plug provided.

Options

- Universal, high efficiency, drivers cover voltage requirements for 120-277 Vac and 347-480 Vac, 50/60 Hz +/- 10%.
- Standard 2KV surge suppression.
- Safety cable for fall safe retention; add suffix **-C** to the end of the catalog number.
- Fusing is available;
 - Add suffix **-F** to the end of the catalog number. ⌘
- Diffused lens is available;
 - Add suffix **-D** to the end of the catalog number.
- For emergency battery backup refer to Viamaster LED Series Emergency Luminaires.

Standard Materials

- Housing: copperfree (4/10 of 1% max.) aluminum
- Lens: thermal shock- and impact-resistant polycarbonate lens
- Gasket: silicone rubber, mechanically secured
- Bolts: stainless steel
- Close up plugs: nickel plated brass
 - Mounting hardware: See ordering information

Standard Finishes

- Housing: gray polyester

Related Products

- For ATEX/IECEx certified products, refer to Viamaster LED Series Luminaires for ATEX and IECEx Governed Locations

NEC/CEC Certifications and Compliances

- UL Standard: UL 1598, UL 8750, UL 844, UL1598A, UL50E
- CSA Standards: C22.2 No. 250.0, C22.2 No. 137
- cCSAus Certified: 065182. cULus E10444
- Ambient Temperature:
 - LU: 120-277 Volts: -40 °C up to +65 °C (-40 °F up to +149 °F)
 - BH: 347-480 Volts: -40 °C up to +65 °C (-40 °F up to +149 °F)

Viamaster™ LED Series Luminaires

For NEC and CEC Governed Hazardous Locations

NEC/CEC:
 Class I, Division 2, Groups A, B, C, D
 Class I, Zone 2, Group IIC
 Class II, Division 2, Groups F, G
 Class III
 Type 3R, 4, 4X

NEC/CEC:
 Marine Outside Type- For USA Only ⌘
 IP66/IP67

Order using catalog numbering guides below or select catalog number from tables on following pages.

Catalog Numbering Guide – NEC/CEC Certified Linear LED

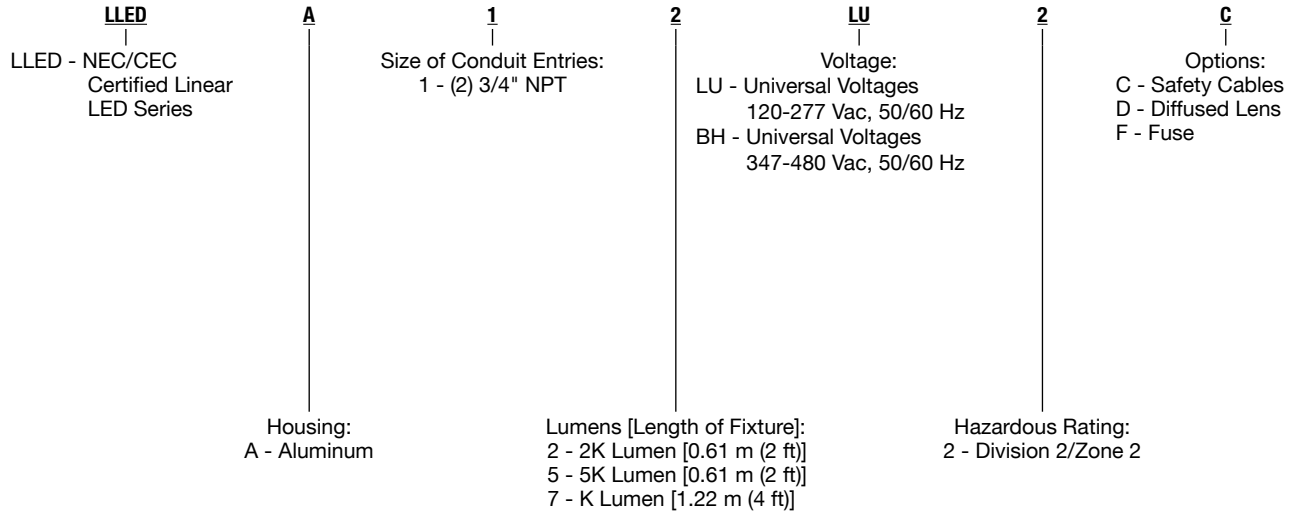

Lamp Comparison Chart

Catalog Number	Line Current Amps	Input Power	Power Factor	THD	Lumens			Color Temp CCT	Length m (ft)
					Clear Polycarbonate	Diffused Polycarbonate	CRI		
NEC/CEC									
LLEDA12LU2	.20@120V	22	>0.95	<20%	2200	1800	70	5650K	0.61 (2)
	.12@277V		>0.87						
	.07@347V		>.95						
LLEDA12BH2	.06@480V	>.77							
	.37@120V	45	>.95	<20%	4400	3800	70	5650K	0.61 (2)
	.17@277V								
.14@347V									
LLEDA15BH2	.10@480V								
	.70@120V	81	>.95	<20%	7800	6400	70	5650K	1.22 (4)
	.31@277V								
.24@347V									
LLEDA17BH2	.18@480V								

⌘ Fusing option not available with Marine Outside Type (Salt Water) rating. Fusing option not permitted for cUL.

Viamaster™ LED Series Luminaires

For NEC and CEC Governed Hazardous Locations

NEC/CEC:
 Class I, Division 2, Groups A, B, C, D
 Class I, Zone 2, Group IIC
 Class II, Division 2, Groups F, G
 Class III
 Type 3R, 4, 4X

NEC/CEC:
 Marine Outside Type- For USA Only ‡
 IP66/IP67

Technical Data ①

Lamp		Ambient Temperature °C (°F)	Supply Wire Temperature °C (°F)	Gas		NEC/CEC		Dust	
Model	Type			Class I, Division 2 ②	Groups	Class I, Zone 2, AEx nA IIC, Ex nA IIC	Class II, Division 2 ③	Groups	
LLEDA12LU2	LED	40 (104)	75 (167)	T4	A, B, C, D	T4	T5	F, G	
		55 (131)	75 (167)	T4	A, B, C, D	T4	T5	F, G	
		65 (149)	75 (167)	T4	A, B, C, D	T4	T4A	F, G	
LLEDA12BH2	LED	40 (104)	75 (167)	T4A	A, B, C, D	T4	T6	F, G	
		55 (131)	75 (167)	T4A	A, B, C, D	T4	T5	F, G	
		65 (149)	75 (167)	T4	A, B, C, D	T4	T4A	F, G	
LLEDA15LU2	LED	40 (104)	75 (167)	T4A	A, B, C, D	T4	T5	F, G	
		55 (131)	75 (167)	T4	A, B, C, D	T4	T4A	F, G	
		65 (149)	75 (167)	T4	A, B, C, D	T4	T4A	F, G	
LLEDA15BH2	LED	40 (104)	75 (167)	T4	A, B, C, D	T4	T5	F, G	
		55 (131)	75 (167)	T4	A, B, C, D	T4	T4A	F, G	
		65 (149)	75 (167)	T4	A, B, C, D	T4	T4A	F, G	
LLEDA17LU2	LED	40 (104)	75 (167)	T4A	A, B, C, D	T4	T5	F, G	
		55 (131)	75 (167)	T5	A, B, C, D	T5	T4A	F, G	
		65 (149)	75 (167)	T4	A, B, C, D	T4	T4A	F, G	
LLEDA17BH2	LED	40 (104)	75 (167)	T4A	A, B, C, D	T4	T5	F, G	
		55 (131)	75 (167)	T4A	A, B, C, D	T4	T5	F, G	
		65 (149)	75 (167)	T4	A, B, C, D	T4	T4A	F, G	

T Code data is per UL Certification.

“T” Numbers Represent the Maximum Internal Temperature ② or Maximum Surface Temperature ③

“T” #	NEC/CEC															
	T1	350	325	T2	T2A	T2B	T2C	T2D	T3	T3A	T3B	T3C	T4	T4A	T5	T6
Temp. Range °C (°F)	351-450 (664-842)	326-350 (619-662)	301-325 (574-617)	281-300 (538-572)	261-280 (502-536)	231-260 (448-500)	216-230 (421-446)	201-215 (394-419)	181-200 (358-392)	166-180 (331-356)	161-165 (322-329)	136-160 (277-320)	121-135 (250-275)	101-120 (214-248)	86-100 (187-212)	85 (185)

① T codes provided in catalog pages are based on worst case data.

② T numbers represent the maximum internal temperature for Class I, Division 2 and Class I, Zone 2 locations designated by the NEC.

③ T numbers represent the maximum surface temperature under a dust blanket for Class II, Division 1 and 2 as designated by the NEC.

‡ Fusing option not available with Marine Outside Type (Salt Water) rating. Fusing option not permitted for cUL.

Viamaster™ LED Series Luminaires



For NEC and CEC Governed Hazardous Locations

NEC/CEC:

Class I, Division 2, Groups A, B, C, D
 Class I, Zone 2, Group IIC
 Class II, Division 2, Groups F, G
 Class III
 Type 3R, 4, 4X

NEC/CEC:

Marine Outside Type- For USA Only ⌘
 IP66/IP67

	Conduit/Cable Entries	Voltage	Weight kg (lb)	Catalog Numbers ①	
				Clear Polycarbonate	Diffused Polycarbonate
2,200 Lumens — 0.61 m (2 ft)					
	3/4" NPT (2)	120-277 Vac, 50/60 Hz	6.21 (13.7)	LLEDA12LU2	LLEDA12LU2D
	3/4" NPT (2)	347-480 Vac, 50/60 Hz		LLEDA12BH2	LLEDA12BH2D
4,400 Lumens — 0.61 m (2 ft)					
	3/4" NPT (2)	120-277 Vac, 50/60 Hz	6.35 (14.0)	LLEDA15LU2	LLEDA15LU2D
	3/4" NPT (2)	347-480 Vac, 50/60 Hz		LLEDA15BH2	LLEDA15BH2D
7,800 Lumens — 1.22 m (4 ft)					
	3/4" NPT (2)	120-277 Vac, 50/60 Hz	8.69 (19.15)	LLEDA17LU2	LLEDA17LU2D
	3/4" NPT (2)	347-480 Vac, 50/60 Hz		LLEDA17BH2	LLEDA17BH2D

① For optional safety cables, add suffix **-C** to the end of the catalog number. For optional fuse, add suffix **-F** to the end of the catalog number.
 Example: LLEDA12LU2CDF.

⌘ Fusing option not available with Marine Outside Type (Salt Water) rating. Fusing option not permitted for cUL.

Viamaster™ LED Series Luminaires

For NEC and CEC Governed Hazardous Locations

NEC/CEC:
 Class I, Division 2, Groups A, B, C, D
 Class I, Zone 2, Group IIC
 Class II, Division 2, Groups F, G
 Class III
 Type 3R, 4, 4X

NEC/CEC:
 Marine Outside Type- For USA Only ⌘
 IP66/IP67

Accessories and Replacement Parts

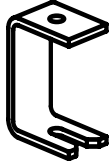
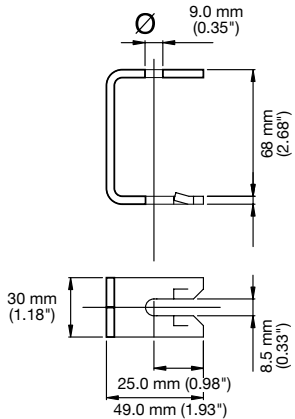
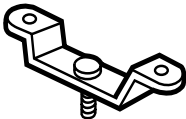
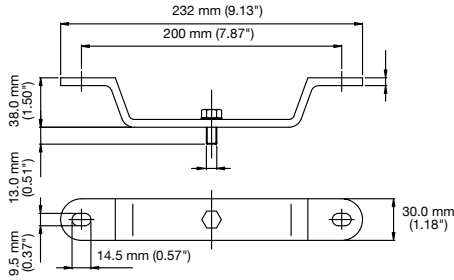
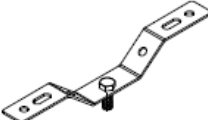
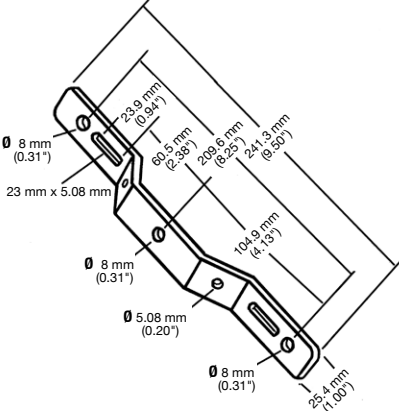
	Description	Catalog Numbers
<p>Mounting Brackets – Set of Two</p>  	<p>Surface Mounting</p> <p>316 stainless steel</p>	<p>FEFBS</p>
 	<p>Surface Mounting</p> <p>Aluminium (gray painted) 316 stainless steel</p>	<p>FESBA FESBS</p>
 	<p>Surface Mounting</p> <p>14-gauge stainless steel</p>	<p>FVSM</p>

⌘ Fusing option not available with Marine Outside Type (Salt Water) rating. Fusing option not permitted for cUL.

Viamaster™ LED Series Luminaires

For NEC and CEC Governed Hazardous Locations

NEC/CEC:
 Class I, Division 2, Groups A, B, C, D
 Class I, Zone 2, Group IIC
 Class II, Division 2, Groups F, G
 Class III
 Type 3R, 4, 4X

NEC/CEC:
 Marine Outside Type- For USA Only ‡
 IP66/IP67

Accessories and Replacement Parts

	Description	Catalog Numbers
<p>Mounting Brackets — Set of Two</p>	<p>Hinged Brackets</p> <p>Aluminium</p>	<p>FEHBA</p>
	<p>Fixed 45° Wall Mount</p> <p>11-gauge (1/8") stainless steel</p>	<p>FVWFM</p>
	<p>M8 Ring Bolts</p> <p>Zinc plated steel — For use with optional safety chain (not provided)</p>	<p>FERBM8Z</p>
<p>Safety Cables — Set of Two</p>	<p>Safety Cables — Attached to fixtures to guard against them falling when the primary method of attachment fails.</p>	<p>LLEDSC</p>
<p>Replacement Drivers</p>	<p>120-277 Vac driver (-40 °C to +65 °C) 347-480 Vac driver</p>	<p>LLEDBU2 LLEDBH</p>
<p>Replacement Lenses</p>	<p>Clear Polycarbonate lens with an integral gasket Diffused lens with an integral gasket</p>	<p>LLEDGPL LLEDDPL</p>

‡ Fusing option not available with Marine Outside Type (Salt Water) rating. Fusing option not permitted for cUL.

Viamaster™ LED Series Luminaires

For NEC and CEC Governed Hazardous Locations

NEC/CEC:
 Class I, Division 2, Groups A, B, C, D
 Class I, Zone 2, Group IIC
 Class II, Division 2, Groups F, G
 Class III
 Type 3R, 4, 4X

NEC/CEC:
 Marine Outside Type- For USA Only ⌘
 IP66/IP67

Mounting Option Dimensions in Millimeters (Inches)

FEBFS

Ceiling/Surface Mount

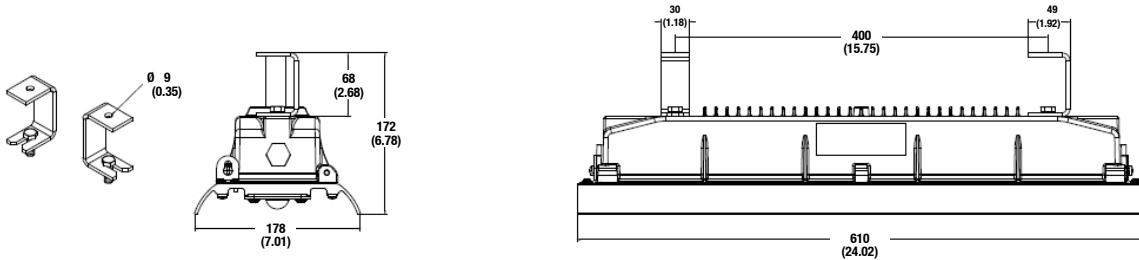

FESBA Aluminum (gray painted)
FESBS 316 stainless steel

Ceiling/Surface Mount

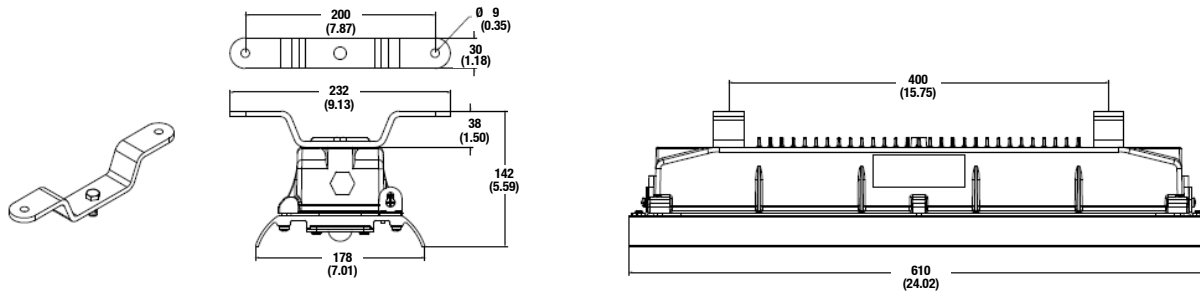

FVSM

Ceiling/Surface Mount

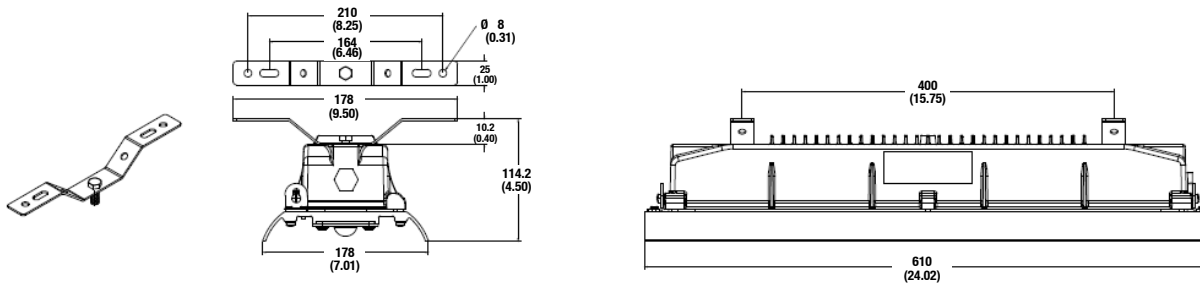

⌘ Fusing option not available with Marine Outside Type (Salt Water) rating. Fusing option not permitted for cUL.

Viamaster™ LED Series Luminaires

For NEC and CEC Governed Hazardous Locations

NEC/CEC:
 Class I, Division 2, Groups A, B, C, D
 Class I, Zone 2, Group IIC
 Class II, Division 2, Groups F, G
 Class III
 Type 3R, 4, 4X

NEC/CEC:
 Marine Outside Type- For USA Only ⌘
 IP66/IP67

Mounting Options (continued) Dimensions in Millimeters (Inches)

FEHBA

Wall/Hinged Mount

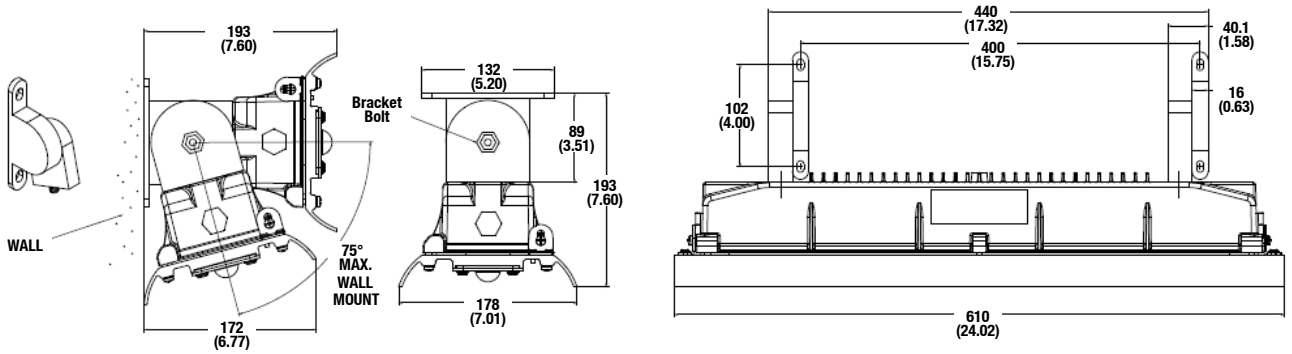

FVWFM

Wall/Fixed 45° Mount

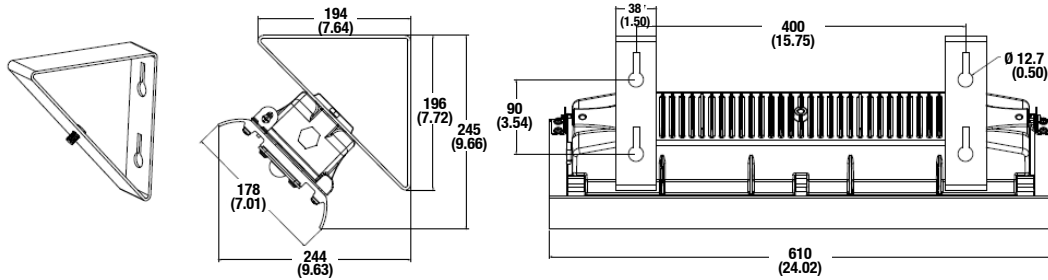

FERBM8Z

Ceiling/Chain Mount

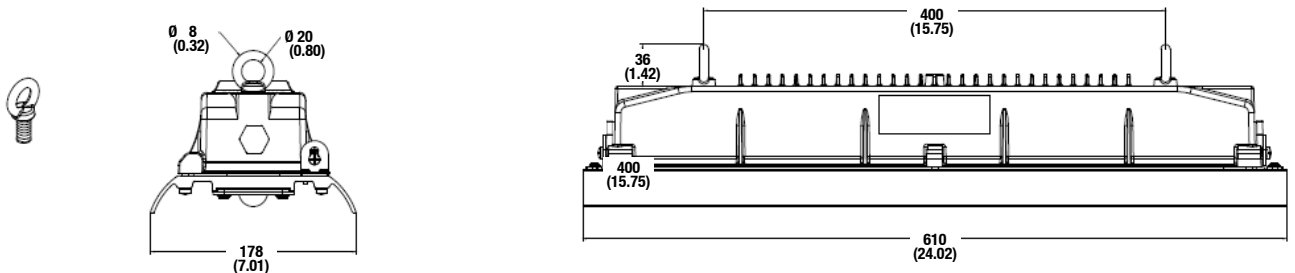

⌘ Fusing option not available with Marine Outside Type (Salt Water) rating. Fusing option not permitted for cUL.

Viamaster™ LED Series Luminaires

For NEC and CEC Governed Hazardous Locations

NEC/CEC:
 Class I, Division 2, Groups A, B, C, D
 Class I, Zone 2, Group IIC
 Class II, Division 2, Groups F, G
 Class III
 Type 3R, 4, 4X

NEC/CEC:
 Marine Outside Type- For USA Only ⌘
 IP66/IP67

Luminaire Dimensions in Millimeters (Inches)

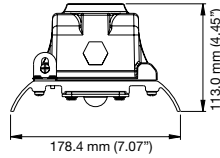

End View — 0.61 m (2 ft) and 1.22 m (4 ft) Versions

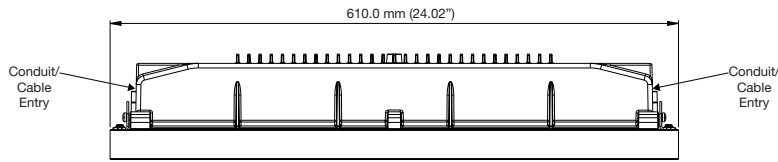

Side View — 0.61 m (2 ft) Versions

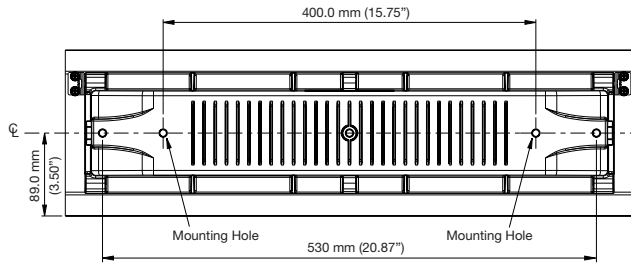

Top (Mounting) View — 0.61 m (2 ft) Versions

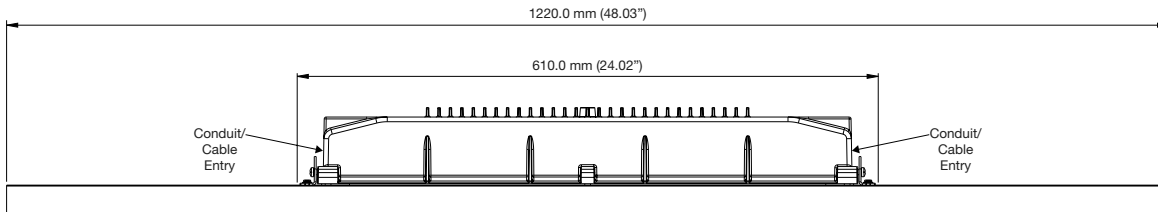

Side View — 1.22 m (4 ft) Version

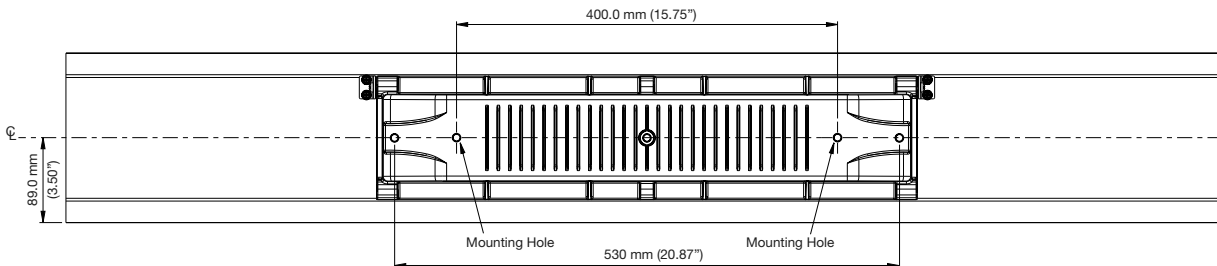

Top (Mounting) View — 1.22 m (4 ft) Version

⌘ Fusing option not available with Marine Outside Type (Salt Water) rating. Fusing option not permitted for cUL.

Viamaster™ LED Series Luminaires

For NEC and CEC Governed Hazardous Locations

NEC/CEC:
 Class I, Division 2, Groups A, B, C, D
 Class I, Zone 2, Group IIC
 Class II, Division 2, Groups F, G
 Class III
 Type 3R, 4, 4X

NEC/CEC:
 Marine Outside Type- For USA Only ⌘
 IP66/IP67

Photometric Data – DATA SHOWN IS ABSOLUTE

LLEDA12LU2 with Clear Polycarbonate Lens

Zonal Lumens and Percentages at 25°C

Zone	Lumens	% Luminaire	Zone	Lumens	% Luminaire
0-30	424.1	20.2	0-10	46.7	2.2
0-40	741.2	35.4	10-20	140.9	6.7
0-60	1521	72.6	20-30	236.4	11.3
60-90	573.3	27.4	30-40	317.2	15.1
0-90	2094	100.0	40-50	378.4	18.1
90-180	0.3	0.0	50-60	401.5	19.2
0-180	2095	100.0	60-70	324.6	15.5
			70-80	209.6	10.0
			80-90	39.1	1.9
			90-100	0.3	0.0

Polar Candela Distribution

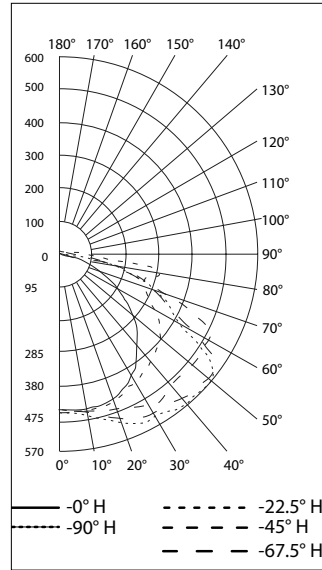

Isoillumination Plot

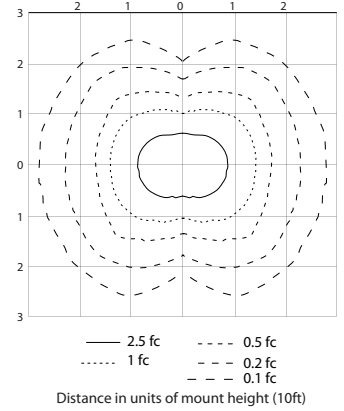

LLEDA12LU2D with Diffused Polycarbonate Lens

Zonal Lumens and Percentages at 25°C

Zone	Lumens	% Luminaire	Zone	Lumens	% Luminaire
0-30	429.7	24.6	0-10	52.8	3.0
0-40	702.7	40.3	10-20	150.5	8.6
0-60	1264	72.4	20-30	226.5	13.0
60-90	482.0	27.6	30-40	272.9	15.6
0-90	1746	100.0	40-50	287.4	16.5
90-180	0.0	0.0	50-60	273.6	15.7
0-180	1746	100.0	60-70	236.9	13.6
			70-80	183.1	10.5
			80-90	62.1	3.6

Polar Candela Distribution

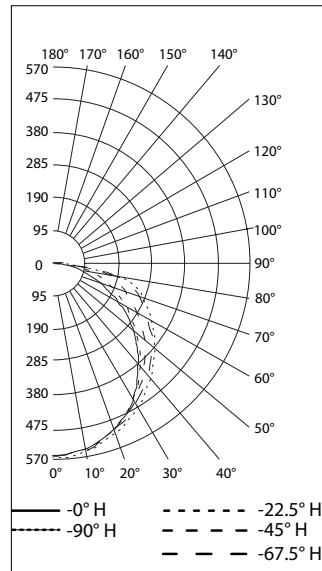

Isoillumination Plot

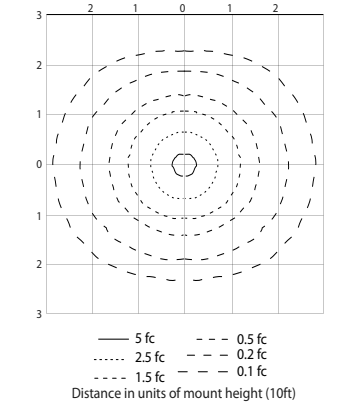

⌘ Fusing option not available with Marine Outside Type (Salt Water) rating. Fusing option not permitted for cUL.

Viamaster™ LED Series Luminaires

For NEC and CEC Governed Hazardous Locations

NEC/CEC:
 Class I, Division 2, Groups A, B, C, D
 Class I, Zone 2, Group IIC
 Class II, Division 2, Groups F, G
 Class III
 Type 3R, 4, 4X

NEC/CEC:
 Marine Outside Type- For USA Only ⌘
 IP66/IP67

Photometric Data — DATA SHOWN IS ABSOLUTE

LLEDA15LU2 with Clear Polycarbonate Lens

Zonal Lumens and Percentages at 25°C

Zone	Lumens	% Luminaire	Zone	Lumens	% Luminaire
0-30	912.8	20.3	0-10	100.4	2.2
0-40	1593	35.5	10-20	303.6	6.8
0-60	3282	73.0	20-30	508.8	11.3
60-90	1206	26.8	30-40	680.0	15.1
0-90	4488	99.9	40-50	822.5	18.3
90-180	4.5	0.1	50-60	866.3	19.3
0-180	4492	100.0	60-70	682.0	15.2
			70-80	438.3	9.8
			80-90	85.9	1.9
			90-100	4.2	0.1
			100-110	0.3	0.0

Polar Candela Distribution

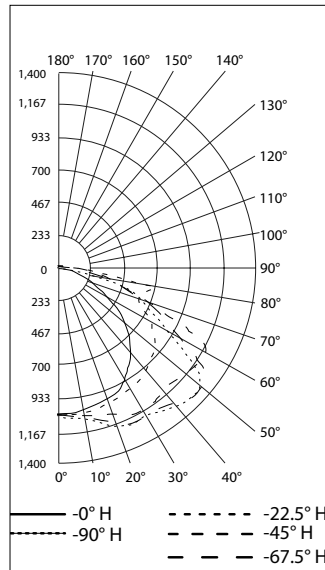

Isoillumination Plot

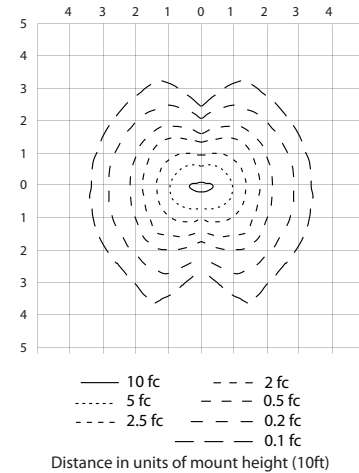

LLEDA15LU2D with Diffused Polycarbonate Lens

Zonal Lumens and Percentages at 25°C

Zone	Lumens	% Luminaire	Zone	Lumens	% Luminaire
0-30	884.1	24.3	0-10	108.2	3.0
0-40	1450	39.8	10-20	308.9	8.5
0-60	2618	71.9	20-30	467.0	12.8
60-90	1017	27.9	30-40	565.5	15.5
0-90	3635	99.8	40-50	598.1	16.4
90-180	7.9	0.2	50-60	570.3	15.7
0-180	3643	100.0	60-70	494.4	13.6
			70-80	382.9	10.5
			80-90	139.8	3.8
			90-100	7.4	0.2
			100-110	0.5	0.0

Polar Candela Distribution

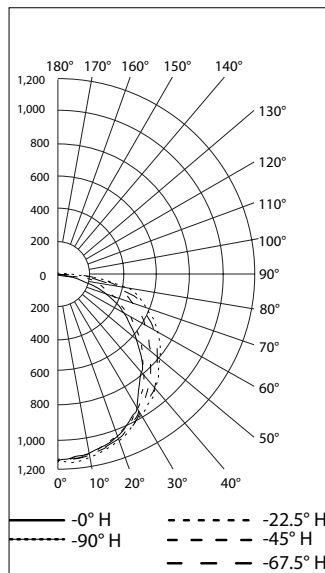

Isoillumination Plot

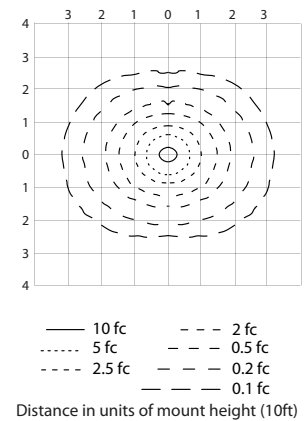

⌘ Fusing option not available with Marine Outside Type (Salt Water) rating. Fusing option not permitted for cUL.

Viamaster™ LED Series Luminaires

For NEC and CEC Governed Hazardous Locations

NEC/CEC:
 Class I, Division 2, Groups A, B, C, D
 Class I, Zone 2, Group IIC
 Class II, Division 2, Groups F, G
 Class III
 Type 3R, 4, 4X

NEC/CEC:
 Marine Outside Type- For USA Only ⌘
 IP66/IP67

Photometric Data — DATA SHOWN IS ABSOLUTE

LLEDA17LU2 with Clear Polycarbonate Lens

Zonal Lumens and Percentages at 25°C

Zone	Lumens	% Luminaire	Zone	Lumens	% Luminaire
0-30	1560	20.0	0-10	170.7	2.2
0-40	2728	34.9	10-20	518.4	6.6
0-60	5631	72.1	20-30	870.5	11.2
60-90	2171	27.8	30-40	1168	15.0
0-90	7802	100.0	40-50	1406	18.0
90-180	2.8	0.0	50-60	1497	19.2
0-180	7805	100.0	60-70	1229	15.7
			70-80	785.7	10.1
			80-90	156.6	2.0
			90-100	2.7	0.0

Polar Candela Distribution

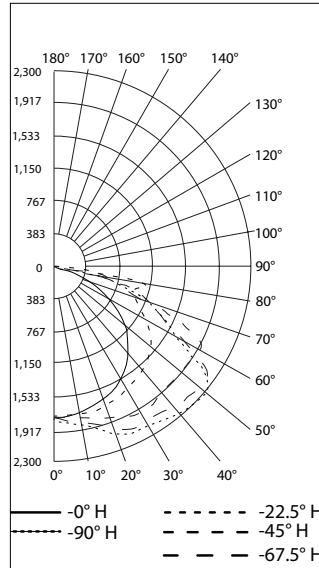

Isoillumination Plot

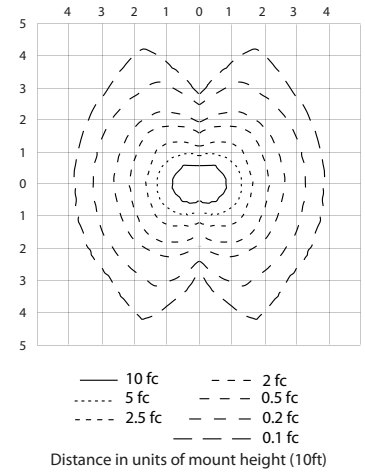

LLEDA17LU2D with Diffused Polycarbonate Lens

Zonal Lumens and Percentages at 25°C

Zone	Lumens	% Luminaire	Zone	Lumens	% Luminaire
0-30	1518	24.1	0-10	185.3	2.9
0-40	2494	39.5	10-20	529.7	8.4
0-60	4528	71.8	20-30	802.9	12.7
60-90	1775	28.1	30-40	976.2	15.5
0-90	6303	99.9	40-50	1038	16.5
90-180	3.4	0.1	50-60	995.8	15.8
0-180	6307	100.0	60-70	868.1	13.8
			70-80	673.7	10.7
			80-90	233.4	3.7
			90-100	3.4	0.1

Polar Candela Distribution

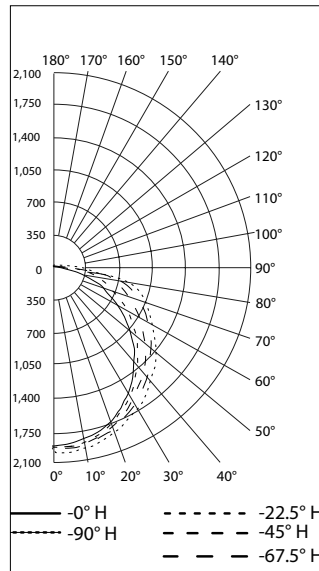

Isoillumination Plot

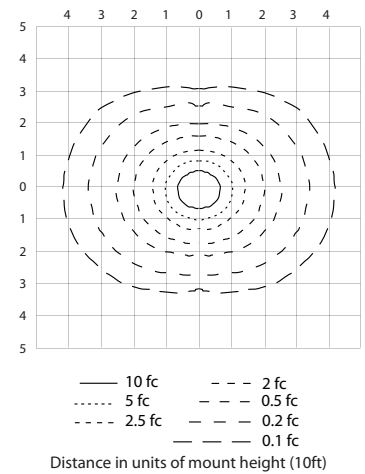

⌘ Fusing option not available with Marine Outside Type (Salt Water) rating. Fusing option not permitted for cUL.

Viamaster™ LED Series Luminaires

For ATEX and IECEx Governed Hazardous Locations

ATEX/IECEX:
Zones 2 and 22
Ⓜ II 3 GD
EPL Gc and Dc
Ex nA IIC; Ex tc IIIC
IP66/IK08

ATEX/IECEX:
Zone 21
Ⓜ II 2 D
EPL Db
Ex tb IIIC
IP66/IK08

Applications

- For use in locations where:
 - Flammable gases, vapors and dusts are present
 - A high degree of corrosion resistance is required
 - Protection against dirt, water and moisture is necessary
- Typical applications include:
 - Oil refineries
 - Petrochemical facilities
 - Pulp and paper mills
 - Food processing plants
 - Waste and sewer treatment
 - Underground tunnels
 - General manufacturing facilities

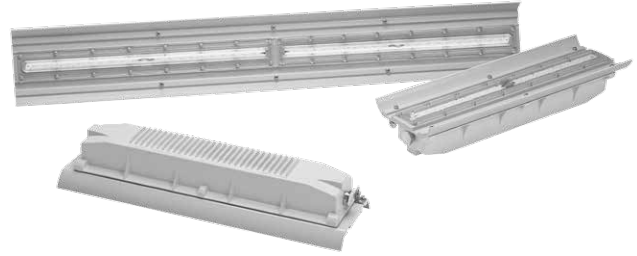

Features

- 60,000+ hour LED life for years of maintenance free operation.
- Lightweight design, hinged cover with captive screws, and terminal block wiring for easy installation and maintenance.
- Standard screw-type terminal block can accept 1 to 6 mm² wire.
- Contemporary, low profile design suitable for tight spaces.
- Field replaceable LED driver and lens.
- Industry-leading thermal management for safe, reliable operation over wide temperature range.
- Full range of lumen outputs, with light distribution equivalent to Appleton's FN Series fluorescent fixtures
- Easy to retrofit in same mounting footprint as Appleton's FE/FN Series fluorescent fixtures.
- M20 plug or M25 plug provided.
- Universal, high efficiency, drivers cover voltage requirements for 120-277 Vac, 50/60 Hz +/- 10%.
- Standard 2KV surge suppression.

Options

- Safety cable for fall safe retention; add suffix **-C** to the end of the catalog number.

Standard Materials

- Housing: copperfree (4/10 of 1% max.) aluminum
- Lens: thermal shock- and impact-resistant polycarbonate lens
- Gasket: silicone rubber, mechanically secured
- Bolts: stainless steel
- Close up plugs: nickel plated brass
 - Mounting hardware: See ordering information

Standard Finishes

- Housing: gray RAL 7038 epoxy

Related Products

- For NEC/CEC certified products, refer to Viamaster LED Series Luminaires for NEC and CEC Governed Hazardous Locations

ATEX/IECEX Certifications and Compliances

- Certification Type: LLEDA
 - Gas: Zone 2
 - Conforming to ATEX 94/9/EC: Ⓜ II 3 G
 - Protection Level: EPL Gc
 - Type of Protection: Ex nA IIC
 - Temperature Class: See *Technical Data table* (T6 to T3)
 - EC Declaration of Conformity: 50309
 - ATEX Certificate: LCIE 15 ATEX 1003X
 - IECEx Certificate: IECEx LCIE 15.0010X
 - Dust: Zones 21 and 22
 - Conforming to ATEX 94/9/EC: Ⓜ II 2 D and II 3 D
 - Protection Level: EPL Db and Dc
 - Type of Protection: Ex tb IIIC and Ex tc IIIC
 - Surface Temperature: See *Technical Data table* [+63 °C to +84 °C (+145 °F to +183 °F)]
 - EC Declaration of Conformity: 50309
 - ATEX Certificate, Zone 21: LCIE 15 ATEX 3006X
 - ATEX Certificate, Zone 22: LCIE 15 ATEX 1003X
 - IECEx Certificate, Zone 21 and 22: IECEx LCIE 15.0010X
- Ambient Temperature:
 - LLEDA2: -40 °C up to +65 °C (-40 °F up to +149 °F)
 - LLEDA5/7: -40 °C up to +60 °C (-40 °F up to +140 °F)
- Index of Protection according EN/IEC 60529: IP66
- Impact Resistance (shock): IK08
- Ex Standards: EN/IEC 60079-0; 60079-15; 60079-31
- Product Standards: EN/IEC 61347-1; EN/IEC 61347-2-13; 60598-1
- EMC Standards: EN/IEC 61000.4.2; 61000.4.3; 61000.4.4; 61000.4.5; 61000.4.6; 61000.4.8; 61000.4.11; EN/IEC 55015; 61547

Viamaster™ LED Series Luminaires

For ATEX and IECEx Governed Hazardous Locations

ATEX/IECEX:
Zones 2 and 22
II 3 GD
EPL Gc and Dc
Ex nA IIC; Ex tc IIIC
IP66/IK08

ATEX/IECEX:
Zone 21
II 2 D
EPL Db
Ex tb IIIC
IP66/IK08

Order using catalog numbering guides below or select catalog number from tables on following pages.

Catalog Numbering Guide – ATEX/IECEX Certified Linear LED

LLEDA	A	2	L	2	BU	Z2	C
 LLEDA - ATEX/IECEX Certified Linear LED Series	 Housing: A - Aluminum	 Size of Cable Entries: 2 - M20 3 - M25	 Termination/Wiring: L - Loop In/Out (3 entries, 1 at one end and 2 at the other) S - Standard (2 entries on the same side) T - Through Wired (2 entries, one at each end)	 Lumens [Length of Fixture]: 2 - 2K Lumens, [0.61 m (2 ft)] 5 - 5K Lumens, [0.61 m (2 ft)] 7 - 7K Lumens, [1.22 m (4 ft)]	 Voltage: BU - Universal Voltages 120-277 Vac, 50/60 Hz	 Hazardous Rating: Z2 - Zone 2 and 21-22	 Options: C - Safety Cables

Lamp Comparison Chart

Catalog Number	Line Current Amps	Input Power	Power Factor	THD	Lumens		Color Temp CCT	Length m (ft)
					Clear Polycarbonate	CRI		
LLEDAA2S2BUZ2								
LLEDAA3S2BUZ2								
LLEDAA2T2BUZ2	.24 @120V	22 W	> 0.95 >0.87	< 20%	2,200	70	5650K	0.61 (2)
LLEDAA3T2BUZ2	.15 @ 277V							
LLEDAA2L2BUZ2								
LLEDAA3L2BUZ2								
LLEDAA2S5BUZ2								
LLEDAA3S5BUZ2								
LLEDAA2T5BUZ2	.51@120V	45 W	> 0.95	< 20%	4,400	70	5650K	0.61 (2)
LLEDAA3T5BUZ2	.30 @ 277V							
LLEDAA2L5BUZ2								
LLEDAA3L5BUZ2								
LLEDAA2S7BUZ2								
LLEDAA3S7BUZ2								
LLEDAA2T7BUZ2	.90 @120V	81 W	> 0.95	< 20%	7,800	70	5650K	1.22 (4)
LLEDAA3T7BUZ2	.53 @ 277V							
LLEDAA2L7BUZ2								
LLEDAA3L7BUZ2								

Appleton

LED/AREA: NEC/CEC, ATEX/IECEX ENCLOSED AND GASKETED

Viamaster™ LED Series Luminaires

For ATEX and IECEx Governed Hazardous Locations

ATEX/IECEX:
Zones 2 and 22
II 3 GD
EPL Gc and Dc
Ex nA IIC; Ex tc IIIC
IP66/IK08

ATEX/IECEX:
Zone 21
II 2 D
EPL Db
Ex tb IIIC
IP66/IK08

Technical Data

Lamp		Ambient Temperature °C (°F)	Supply Wire Temperature °C (°F)	Zone 2 – 22		Zone 21
Lumen Output	Type			Gas	Dust Surface Temperature °C (°F)	Dust Surface Temperature °C (°F)
				Class of Temperature °C (°F)		
2,200 lm	LED	40 (104)	75 (167)	T6 75 (167)	54 (129)	54 (129)
		55 (131)	75 (167)	T5 90 (203)	69 (156)	69 (156)
		60 (140)	75 (167)	T5 90 (203)	74 (165)	74 (165)
		65 (149)	75 (167)	T5 100 (212)	79 (174)	79 (174)
4,400 lm	LED	40 (104)	75 (167)	T4 129 (264)	64 (147)	64 (147)
		55 (131)	75 (167)	T3 144 (291)	79 (174)	79 (174)
		60 (140)	75 (167)	T3 148 (298)	84 (183)	84 (183)
7,800 lm	LED	40 (104)	75 (167)	T4 130 (266)	64 (147)	64 (147)
		55 (131)	75 (167)	T3 145 (293)	79 (174)	79 (174)
		60 (140)	75 (167)	T3 149 (300)	84 (183)	84 (183)

“T” Numbers Represent the Maximum External Surface Temperature

“T” #	T1	T2	T3	T4	T5	T6
Temp. Range °C (°F)	301-450 (547-842)	201-300 (394-572)	136-200 (277-392)	101-135 (214-275)	86-100 (187-212)	85 (185)



① T codes provided in catalog pages are based on worst case data.
② Zone 2 (Gas) and 22 (Dust) locations as designated by the IEC.

Viamaster™ LED Series Luminaires

For ATEX and IECEx Governed Hazardous Locations

ATEX/IECEX:
Zones 2 and 22
Ⓢ II 3 GD
EPL Gc and Dc
Ex nA IIC; Ex tc IIIC
IP66/IK08

ATEX/IECEX:
Zone 21
Ⓢ II 2 D
EPL Db
Ex tb IIIC
IP66/IK08

Conduit/Cable Entries	Voltage	Ambient Temperature	Weight kg (lb)	Catalog Numbers Clear Polycarbonate	
2,200 Lumens — 0.61 m (2 ft)					
	M20 Standard ①	120-277 Vac, 50/60 Hz	-40 °C up to +65 °C (-40 °F up to +149 °F)	6.21 (13.7)	LLEDAA2S2BUZ2 ④
	M25 Standard ①	120-277 Vac, 50/60 Hz			LLEDAA3S2BUZ2 ④
	M20 Through Wired ②	120-277 Vac, 50/60 Hz	-40 °C up to +65 °C (-40 °F up to +149 °F)	6.21 (13.7)	LLEDAA2T2BUZ2 ④
	M25 Through Wired ②	120-277 Vac, 50/60 Hz			LLEDAA3T2BUZ2 ④
	M20 Loop In/Loop Out ③	120-277 Vac, 50/60 Hz	-40 °C up to +65 °C (-40 °F up to +149 °F)	6.21 (13.7)	LLEDAA2L2BUZ2 ④
	M25 Loop In/Loop Out ③	120-277 Vac, 50/60 Hz			LLEDAA3L2BUZ2 ④
4,400 Lumens — 0.61 m (2 ft)					
	M20 Standard ①	120-277 Vac, 50/60 Hz	-40 °C up to +60 °C (-40 °F up to +140 °F)	6.35 (14.0)	LLEDAA2S5BUZ2 ④
	M25 Standard ①	120-277 Vac, 50/60 Hz			LLEDAA3S5BUZ2 ④
	M20 Through Wired ②	120-277 Vac, 50/60 Hz	-40 °C up to +60 °C (-40 °F up to +140 °F)	6.35 (14.0)	LLEDAA2T5BUZ2 ④
	M25 Through Wired ②	120-277 Vac, 50/60 Hz			LLEDAA3T5BUZ2 ④
	M20 Loop In/Loop Out ③	120-277 Vac, 50/60 Hz	-40 °C up to +60 °C (-40 °F up to +140 °F)	6.35 (14.0)	LLEDAA2L5BUZ2 ④
	M25 Loop In/Loop Out ③	120-277 Vac, 50/60 Hz			LLEDAA3L5BUZ2 ④
7,800 Lumens — 1.22 m (4 ft)					
	M20 Standard ①	120-277 Vac, 50/60 Hz	-40 °C up to +60 °C (-40 °F up to +140 °F)	8.69 (19.15)	LLEDAA2S7BUZ2 ④
	M25 Standard ①	120-277 Vac, 50/60 Hz			LLEDAA3S7BUZ2 ④
	M20 Through Wired ②	120-277 Vac, 50/60 Hz	-40 °C up to +60 °C (-40 °F up to +140 °F)	8.69 (19.15)	LLEDAA2T7BUZ2 ④
	M25 Through Wired ②	120-277 Vac, 50/60 Hz			LLEDAA3T7BUZ2 ④
	M20 Loop In/Loop Out ③	120-277 Vac, 50/60 Hz	-40 °C up to +60 °C (-40 °F up to +140 °F)	8.69 (19.15)	LLEDAA2L7BUZ2 ④
	M25 Loop In/Loop Out ③	120-277 Vac, 50/60 Hz			LLEDAA3L7BUZ2 ④

- ① Standard cable entry provides 2 entries on the same side of the housing.
 ② Through wired cable entry provides 2 entries, one at each end of the housing.
 ③ Loop In/Loop Out cable entry provides 3 entries, 1 at one and 2 at the other end of the housing.
 ④ For optional safety cables, add suffix **-C** to the end of the catalog number.

Viamaster™ LED Series Luminaires

For ATEX and IECEx Governed Hazardous Locations

ATEX/IECEX:
Zones 2 and 22
II 3 GD
EPL Gc and Dc
Ex nA IIC; Ex tc IIIC
IP66/IK08

ATEX/IECEX:
Zone 21
II 2 D
EPL Db
Ex tb IIIC
IP66/IK08

Version : L

Dual Loop In/Out - Through Wiring (Single phase)

3 entries, 1 at one end and 2 at the other

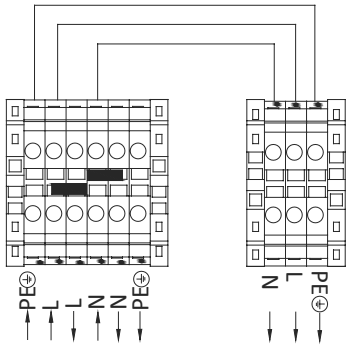

Version : S

Standard

2 entries on the same side

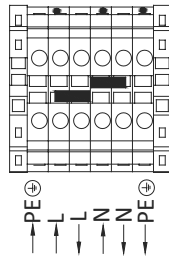

Version : T

Through Wiring (3 phases)

2 entries, one at each end

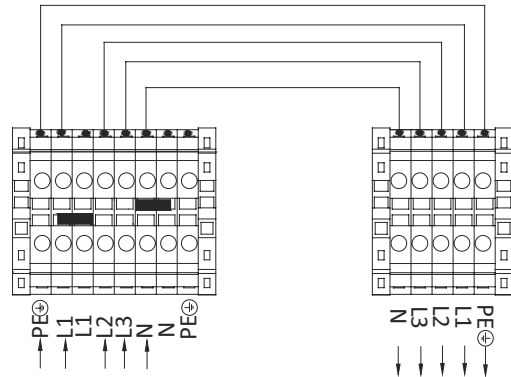

Accessories and Replacement Parts

Mounting Brackets – Set of Two

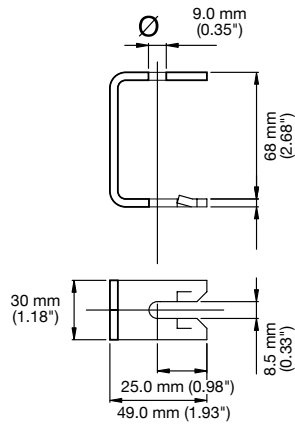
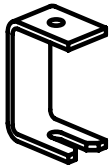

Fixing Brackets for Surface Installation

Zinc plated steel
316 stainless steel

FEFBZ
FEFBS

Surface Mounting

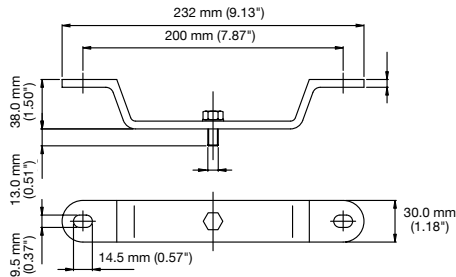
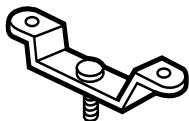

Aluminum (gray painted)
316 stainless steel

FESBA
FESBS

Viamaster™ LED Series Luminaires

For ATEX and IECEx Governed Hazardous Locations

ATEX/IECEx:
Zones 2 and 22
II 3 GD
EPL Gc and Dc
Ex nA IIC; Ex tc IIIC
IP66/IK08

ATEX/IECEx:
Zone 21
II 2 D
EPL Db
Ex tb IIIC
IP66/IK08

Accessories and Replacement Parts

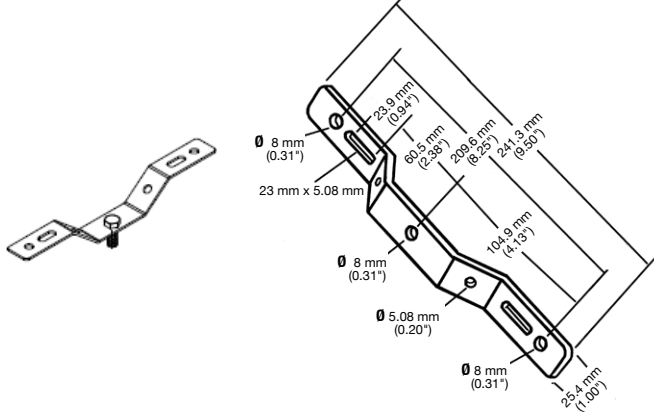
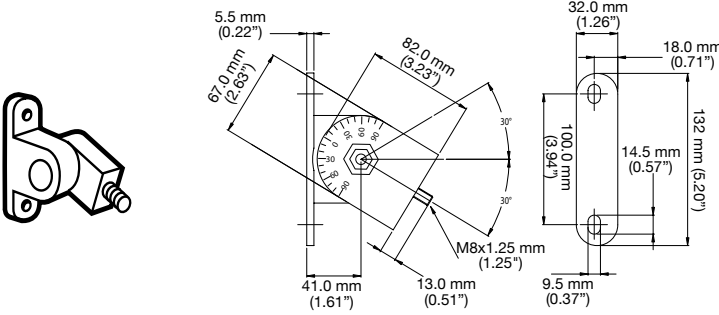
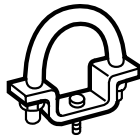
	Description	Catalog Numbers
<p>Mounting Brackets — Set of Two</p> 	<p>Surface Mounting</p> <p>14-gauge stainless steel ①</p>	<p>FVSM</p>
	<p>Hinged Brackets for Adjusting Luminaire</p> <p>Aluminum</p>	<p>FEHBA</p>
	<p>Half Clamp Brackets for Pole Mounting</p> <p>For 42 mm to 49 mm pole (1-1/4 to 1-1/2" tube)</p> <p>Zinc plated steel</p> <p>316 stainless steel</p> <p>For 60 mm pole (2" tube)</p> <p>Zinc plated steel</p> <p>316 stainless steel</p>	<p>FEHC49Z</p> <p>FEHC49S</p> <p>FEHC60Z</p> <p>FEHC60S</p>

① FVSM does not retrofit in same mounting footprint as Appleton's FN/FE series.

Viamaster™ LED Series Luminaires

For ATEX and IECEx Governed Hazardous Locations

ATEX/IECEX:
Zones 2 and 22
II 3 GD
EPL Gc and Dc
Ex nA IIC; Ex tc IIIC
IP66/IK08

ATEX/IECEX:
Zone 21
II 2 D
EPL Db
Ex tb IIIC
IP66/IK08

Accessories and Replacement Parts

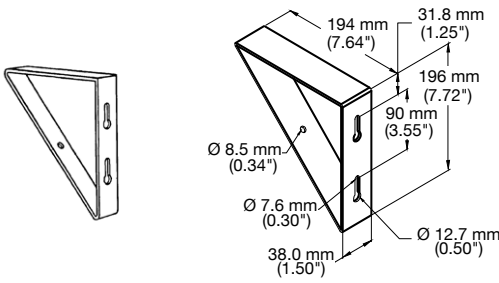
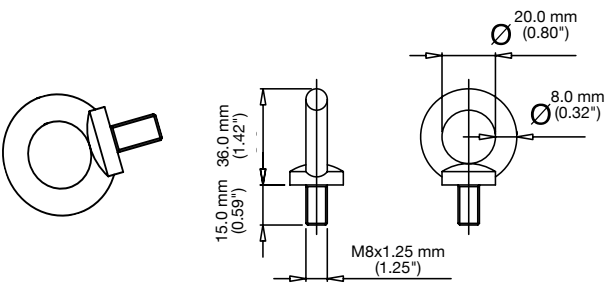
	Description	Catalog Numbers
Mounting Brackets — Set of Two		
	Fixed 45° Wall Mount 11-gauge (1/8") stainless steel ①	FWWFM
	M8 Ring Bolts Zinc plated steel — For use with optional safety chain (not provided)	FERBM8Z
Retrofit Brackets — Set of Two	Adapts mounting holes for 4 foot fixture to 700 mm mounting centers	LLEDRB
Fall Prevention Kit	Safety Cables — Attached to fixtures to guard against them falling when the primary method of attachment fails.	LLEDSC
Replacement Drivers	120-277 Vac driver	LLEDBU2
Replacement Lenses	Clear Polycarbonate lens with an integral gasket	LLEDCLP

① FWWFM does not retrofit in same mounting footprint as Appleton's FNIFE series.

Viamaster™ LED Series Luminaires

For ATEX and IECEx Governed Hazardous Locations

ATEX/IECEX:
 Zones 2 and 22
 II 3 GD
 EPL Gc and Dc
 Ex nA IIC; Ex tc IIIC
 IP66/IK08

ATEX/IECEX:
 Zone 21
 II 2 D
 EPL Db
 Ex tb IIIC
 IP66/IK08

Mounting Options Dimensions in Millimeters (Inches)

FEBBS

Ceiling/Surface Mount

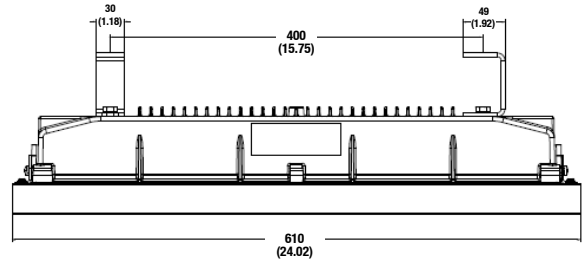
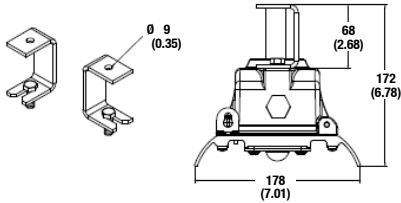

FESBA Aluminum (gray painted)
 FESBS 316 stainless steel

Ceiling/Surface Mount

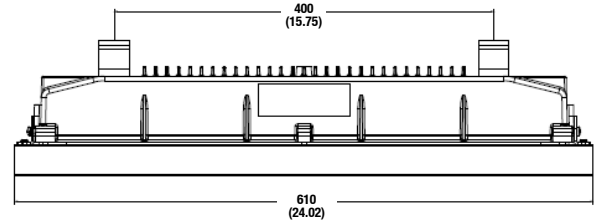
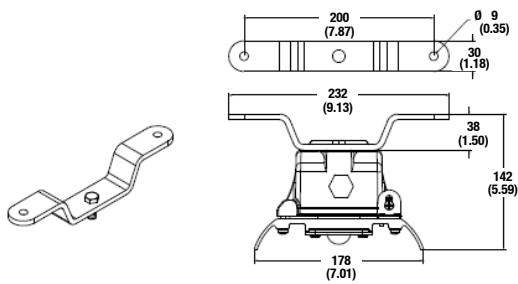

FVSM

Ceiling/Surface Mount

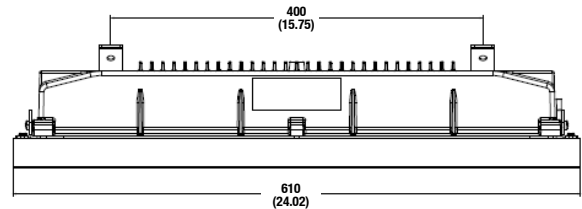
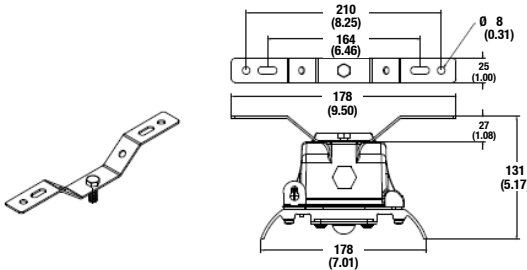

Viamaster™ LED Series Luminaires

For ATEX and IECEx Governed Hazardous Locations

ATEX/IECEX:
 Zones 2 and 22
 II 3 GD
 EPL Gc and Dc
 Ex nA IIC; Ex tc IIIC
 IP66/IK08

ATEX/IECEX:
 Zone 21
 II 2 D
 EPL Db
 Ex tb IIIC
 IP66/IK08

Mounting Options Dimensions in Millimeters (Inches)

FEHBA

Wall/Hinged Mount

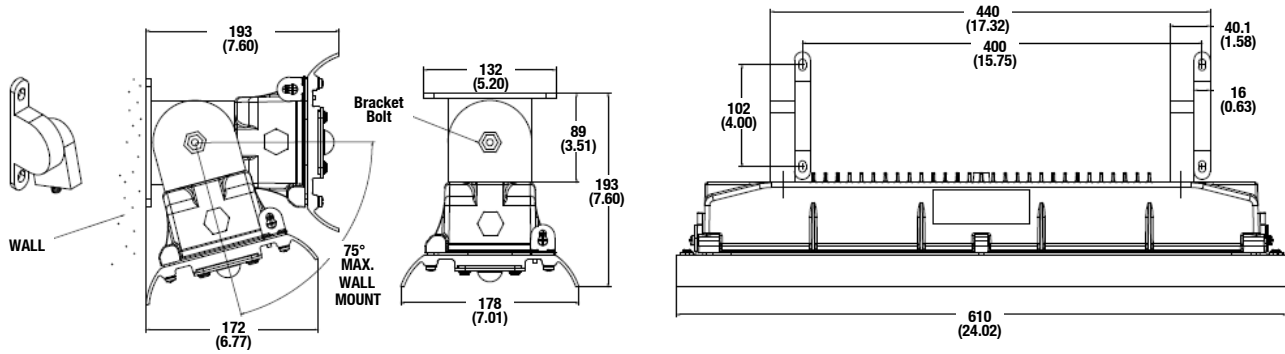

FWWM

Wall/Fixed 45° Mount

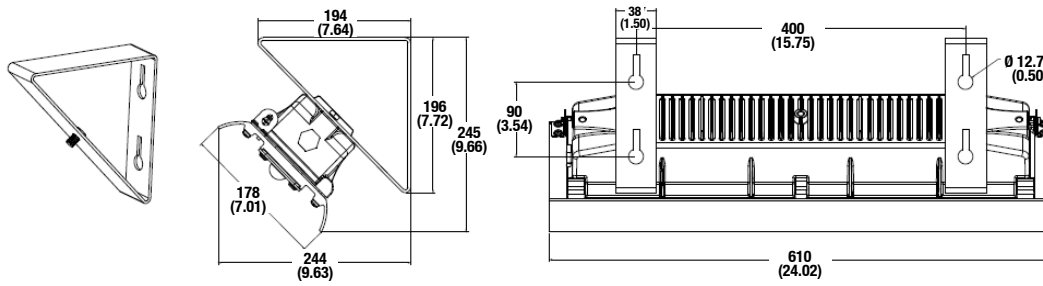

FERBM8Z

Ceiling/Chain Mount

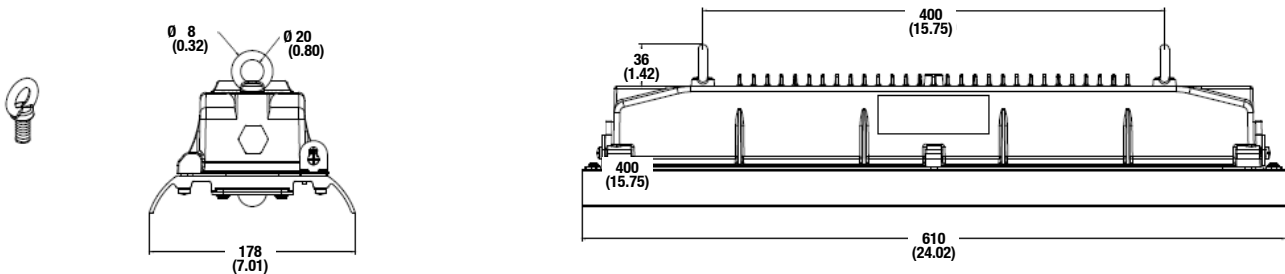

Appleton

LED/AREA: NEC/CEC, ATEX/IECEX ENCLOSED AND GASKETED

Viamaster™ LED Series Luminaires

For ATEX and IECEx Governed Hazardous Locations

ATEX/IECEX:
 Zones 2 and 22
 II 3 GD
 EPL Gc and Dc
 Ex nA IIC; Ex tc IIIC
 IP66/IK08

ATEX/IECEX:
 Zone 21
 II 2 D
 EPL Db
 Ex tb IIIC
 IP66/IK08

Luminaire Dimensions in Millimeters (Inches)

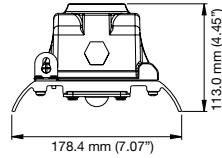

End View — 0.61 m (2 ft) and 1.22 m (4 ft) Versions

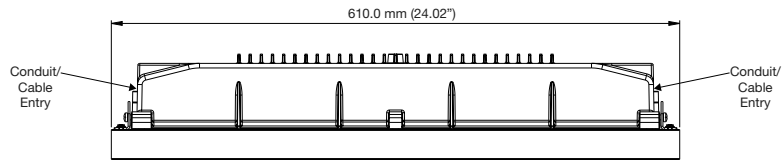

Side View — 0.61 m (2 ft) Versions

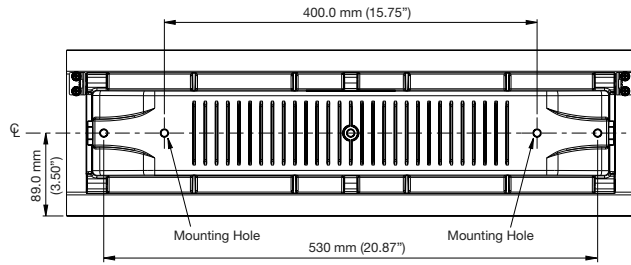

Top (Mounting) View — 0.61 m (2 ft) Versions

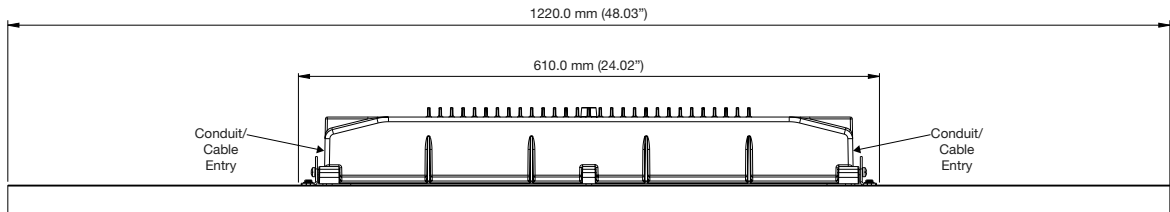

Side View — 1.22 m (4 ft) Version

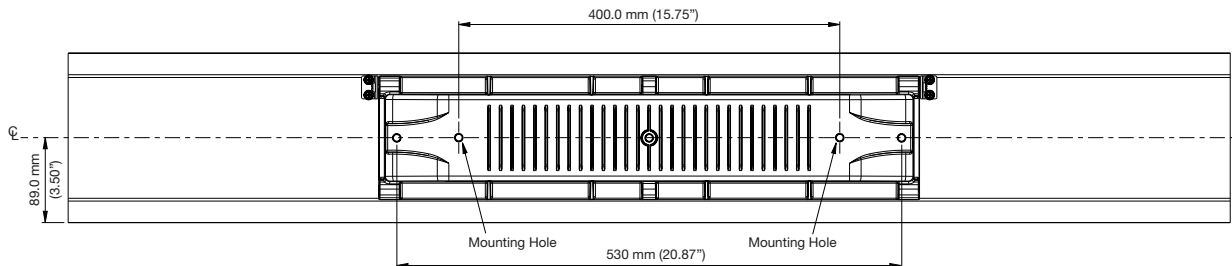

Top (Mounting) View — 1.22 m (4 ft) Version

Appleton®

LED/AREA: NEC/CEC, ATEX/IECEX ENCLOSED AND GASKETED

Viamaster™ LED Series Luminaires

For ATEX and IECEx Governed Hazardous Locations

ATEX/IECEX:
Zones 2 and 22
II 3 GD
EPL Gc and Dc
Ex nA IIC; Ex tc IIIC
IP66/IK08

ATEX/IECEX:
Zone 21
II 2 D
EPL Db
Ex tb IIIC
IP66/IK08

Photometric Data – DATA SHOWN IS ABSOLUTE

LLEDAA(XY)2BUZ2 with Clear Polycarbonate Lens

X = cable entry size, Y = style of termination

Zonal Lumens and Percentages at 25°C

Zone	Lumens	% Luminaire	Zone	Lumens	% Luminaire
0-30	424.1	20.2	0-10	46.7	2.2
0-40	741.2	35.4	10-20	140.9	6.7
0-60	1521	72.6	20-30	236.4	11.3
60-90	573.3	27.4	30-40	317.2	15.1
0-90	2094	100.0	40-50	378.4	18.1
90-180	0.3	0.0	50-60	401.5	19.2
0-180	2095	100.0	60-70	324.6	15.5
			70-80	209.6	10.0
			80-90	39.1	1.9
			90-100	0.3	0.0

Polar Candela Distribution

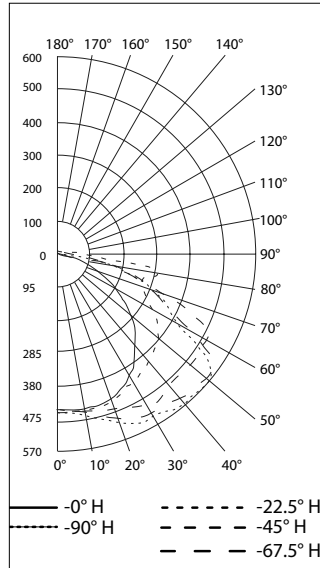

Isoillumination Plot

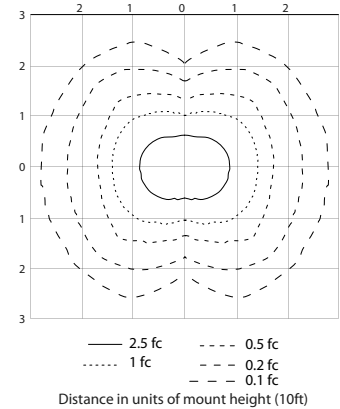

LLEDAA(XY)5BUZ2 with Clear Polycarbonate Lens

X = cable entry size, Y = style of termination

Zonal Lumens and Percentages at 25°C

Zone	Lumens	% Luminaire	Zone	Lumens	% Luminaire
0-30	912.8	20.3	0-10	100.4	2.2
0-40	1593	35.5	10-20	303.6	6.8
0-60	3282	73.0	20-30	508.8	11.3
60-90	1206	26.8	30-40	680.0	15.1
0-90	4488	99.9	40-50	822.5	18.3
90-180	4.5	0.1	50-60	866.3	19.3
0-180	4492	100.0	60-70	682.0	15.2
			70-80	438.3	9.8
			80-90	85.9	1.9
			90-100	4.2	0.1
			100-110	0.3	0.0

Polar Candela Distribution

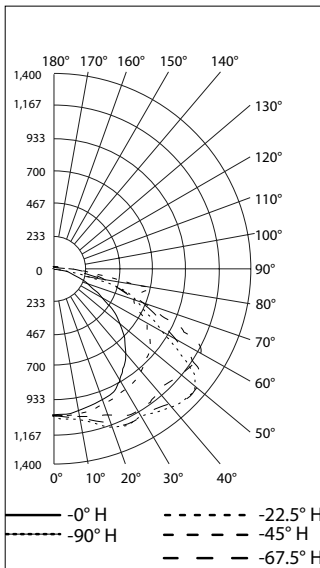

Isoillumination Plot

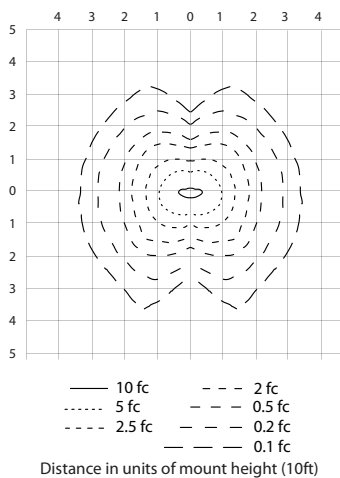

Appleton

LED/AREA: NEC/CEC, ATEX/IECEX ENCLOSED AND GASKETED

Viamaster™ LED Series Luminaires

For ATEX and IECEx Governed Hazardous Locations

ATEX/IECEX:
Zones 2 and 22
II 3 GD
EPL Gc and Dc
Ex nA IIC; Ex tc IIIC
IP66/IK08

ATEX/IECEX:
Zone 21
II 2 D
EPL Db
Ex tb IIIC
IP66/IK08

Photometric Data – DATA SHOWN IS ABSOLUTE

LLEDAA(XY)7BUZ2 with Clear Polycarbonate Lens
X = cable entry size, Y = style of termination

Zonal Lumens and Percentages at 25°C

Zone	Lumens	% Luminaire	Zone	Lumens	% Luminaire
0-30	1560	20.0	0-10	170.7	2.2
0-40	2728	34.9	10-20	518.4	6.6
0-60	5631	72.1	20-30	870.5	11.2
60-90	2171	27.8	30-40	1168	15.0
0-90	7802	100.0	40-50	1406	18.0
90-180	2.8	0.0	50-60	1497	19.2
0-180	7805	100.0	60-70	1229	15.7
			70-80	785.7	10.1
			80-90	156.6	2.0
			90-100	2.7	0.0

Polar Candela Distribution

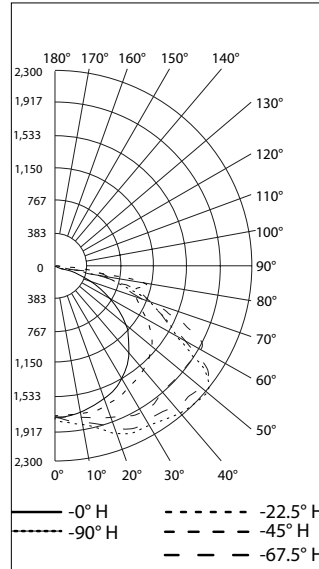

Isoillumination Plot

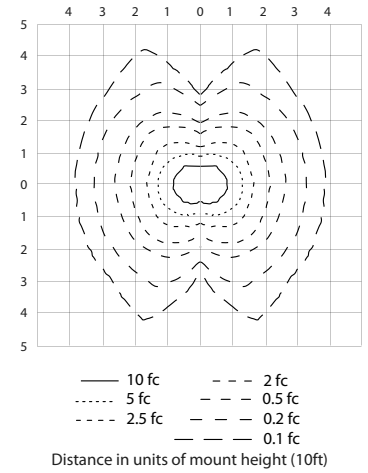

Appleton

LED/AREA: NEC/CEC, ATEX/IECEX ENCLOSED AND GASKETED

Code•Master™ LED Factory Sealed Luminaires

Explosionproof, Dust-Ignitionproof

NEC/CEC:

Class I, Division 1 and 2, Groups B, C, D ★
Class I, Zone 1, Group IIB + H₂
Class II, Division 1, Group E, F, G
Class II, Division 2, Group F, G
Class III

NEC/CEC:

Simultaneous Exposure
Type 3R, 4X
IP66/67
Suitable for Use in Wet Locations
Marine Outside Type (Salt Water) *

Applications

- Explosionproof fixtures suitable for use in:
 - A wide range of hazardous areas where ignitable vapors, dust, moisture and corrosive elements are present
 - Areas where access to relamp is difficult, reliability is essential, and environment is costly to maintain. Consistent light levels maintained regardless of cold temperatures
 - Areas requiring frequent on-and-off of lights or power cycling- no warm up time required
 - Type 4X, marine, wet locations and hose-down environments
 - Areas with high energy costs- Code•Master LED consumes 50% less power than its HID equivalent
- Typical applications include:
 - Chemical
 - Oil, Gas, and Petrochemical
 - Pulp and Paper
 - Foundries
 - Manufacturing
 - Waste and sewage treatment
 - Pharmaceutical
 - Mining
 - Power Generation

Features

- Fixture operates safely in high ambient temperatures
 - 70 W equivalent: -40 °C to +65 °C (-40 °F to +149 °F)
 - 100 W equivalent: -40 °C to +65 °C (-40 °F to +149 °F)
 - 150 W equivalent: -40 °C to +55 °C (-40 °F to +131 °F)
 - 175 W equivalent: -40 °C to +50 °C (-40 °F to +122 °F)
 - 250 W equivalent: -40 °C to +50 °C (-40 °F to +122 °F)
 - 350 W equivalent: -40 °C to +50 °C (-40 °F to +122 °F)
 - 400 W equivalent: -40 °C to +55 °C (-40 °F to +131 °F)
- 60,000 hours rated life eliminates the need for frequent relamping.
- Arrangement of heat-producing components results in more efficient heat dissipation for cooler fixture operation.
- All threaded joints are flame-tight.
- Fixture housing and mounting hoods are copperfree cast aluminum with baked epoxy finish. All exposed hardware is stainless steel.
- Aluminum body utilizes the same Code•Master HID mounting hoods, and is an easy retrofit for existing Code•Master HID installations; can be pendant, ceiling, wall, or stanchion mounted.
- Acme double-lead threads speed installation and fixture removal from mounting hood – only half as many turns are required as for single-lead threads. The threads do not stick or gall, eliminating the troublesome problems often encountered with single lead threads during fixture unit removal.
- Safe, easy servicing without disconnecting any wiring. "Wireless" fixture unit easily threads off mounting hood for convenient servicing or for immediate replacement with a "stand-by" unit.
- Factory sealed. External seals not required.
- Lens, driver, and LED array are all field replaceable.
- LED arrays generate light outputs from 2,580 to 13,730 lumens (an equivalent of 70 W HID to 400 W HID lamps) providing exceptional efficacy



- Universal, high efficiency, drivers cover voltage requirements for 120-277 Vac and 347-480 Vac, 50/60 Hz, Volts +/- 10%.
- Standard surge suppression:
 - 3KV for 347-480 Vac input
 - 4KV for 120-277 Vac input

Standard Materials

- Mounting hoods and bodies: cast copperfree (4/10 of 1% max.) aluminum
- All hardware and catch assemblies: stainless steel
- Gaskets: silicone
- Globe: explosionproof glass

Standard Finishes

- Mounting hoods, bodies, and guards: baked gray epoxy clad finish, electrostatically applied for complete uniform protection

Options

- Safety cable, add suffix **-C**.
- Lens guard, add suffix **-G**.
- Fusing, add suffix **-F** ①★.

NEC/CEC Certifications and Compliances

- UL Standard: UL 50, UL 50E, UL 844, UL 1598, UL 1598A, UL 8750
- CSA Standard: CAN/CSA-C22.2 No. 94.1-07 (R2012), CAN/CSA-C22.2 No. 94.2-07 (R2012), CAN/CSA-C22.2 No. 137-M1981 (R2009), CAN/CSA-C22.2 No. 250.0-08 (R2013), CAN/CSA-C22.2 No. 250.13, CAN/CSA-C22.2 No. 60529-05 (R2010)
- ANSI Standard: ANSI/IEC 60529
- cCSAus Certified: 70030675

① Canadian Electrical Code does NOT allow fusing in hazardous locations. Fuse not CEC rated.

★ Complete Code•Master LED luminaire consists of fixture unit and a mounting hood. For Group B applications a Group B rated mounting hood must be used.

* Use of a fuse voids Marine Outside Type (Salt Water) rating.

Code•Master™ LED Factory Sealed Luminaires

Explosionproof, Dust-Ignitionproof

NEC/CEC:

Class I, Division 1 and 2, Groups B, C, D ★
 Class I, Zone 1, Group IIB + H₂
 Class II, Division 1, Group E, F, G
 Class II, Division 2, Group F, G
 Class III

NEC/CEC:

Simultaneous Exposure
 Type 3R, 4X
 IP66/67
 Suitable for Use in Wet Locations
 Marine Outside Type (Salt Water) *

Illustrated Features



Mounting Hood Compatibility

Code•Master LED is compatible with existing Code•Master mounting hoods. For easy installation, install and wire the mounting hood and simply thread in fixture. Double lead Acme threads are provided for ease of installation.

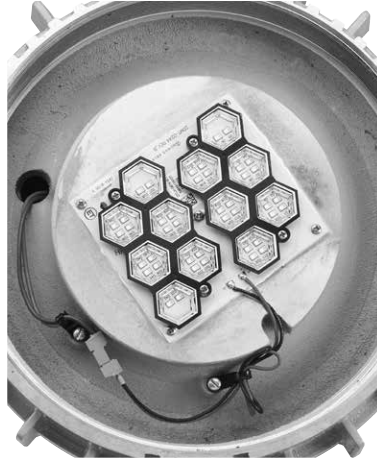

Replaceable LED Array

Replacement LED arrays are available and can be easily installed in the field. Unthread the glass assembly to access the LED array.



Driver Assembly

Utilizing non-sparking components avoiding the ignition of gases or vapors that may be present (nA). Driver can be easily accessed and replaced.



Rugged and Durable Housing

Mounting hoods and bodies are copper free aluminum with baked epoxy-clad finish, electrostatically applied for complete uniform protection.



Replaceable Globe Assembly

The replaceable globe assembly is available with clear glass.



Optional Fusing *

Fuse kit includes fuse, fuse holder and necessary hardware for field installation.

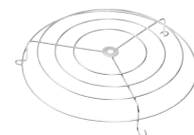

Optional Wire Guard

Stainless steel wire guard can be used for additional protection.

★ Complete Code•Master LED luminaire consists of fixture unit and a mounting hood. For Group B applications a Group B rated mounting hood must be used.
 * Use of a fuse voids Marine Outside Type (Salt Water) rating.
 Canadian Electrical Code does NOT allow fusing in hazardous locations. Fuse not CEC rated.

Code•Master™ LED Factory Sealed Luminaires

Explosionproof, Dust-Ignitionproof

NEC/CEC:

Class I, Division 1 and 2, Groups B, C, D ★
Class I, Zone 1, Group IIB + H₂
Class II, Division 1, Group E, F, G
Class II, Division 2, Group F, G
Class III

NEC/CEC:

Simultaneous Exposure
Type 3R, 4X
IP66/67
Suitable for Use in Wet Locations
Marine Outside Type (Salt Water) *

Order using catalog numbering guides below or select catalog number from tables on following pages.

Catalog Numbering Guide — NEC/CEC Certified Mercmaster LED

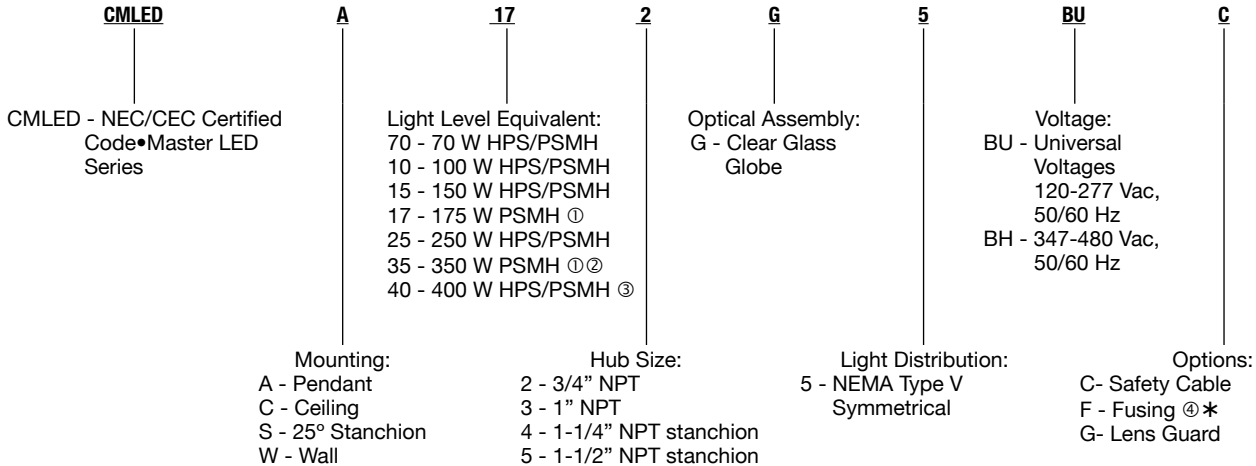

LED/AREA: NEC/CEC EXPLOSIONPROOF/ATEX/IECEx FLAMEPROOF



① Pulse Start Metal Halide only. Does not have a High Pressure Sodium equivalent.

② Available for use with the BH voltage only (347-480 Vac, 50/60 Hz).

③ Available for use with the BU voltage only (120-277 Vac, 50/60 Hz).

④ Canadian Electrical Code does NOT allow fusing in hazardous locations. Fuse not CEC rated.

* Complete Code•Master LED luminaire consists of fixture unit and a mounting hood. For Group B applications a Group B rated mounting hood must be used.

* Use of a fuse voids Marine Outside Type (Salt Water) rating.

Code•Master™ LED Factory Sealed Luminaires

Explosionproof, Dust-Ignitionproof

NEC/CEC:
 Class I, Division 1 and 2, Groups B, C, D ★
 Class I, Zone 1, Group IIB + H₂
 Class II, Division 1, Group E, F, G
 Class II, Division 2, Group F, G
 Class III

NEC/CEC:
 Simultaneous Exposure
 Type 3R, 4X
 IP66/67
 Suitable for Use in Wet Locations
 Marine Outside Type (Salt Water) *

Technical Data

Light Level Equivalent to HID	Lamp Type	Ambient		Supply Wire		
		Temperature °C (°F)	Temperature °C (°F)	Class I, Division 1	Class I, Zone 1	Class II, Division 1
70 Watt	CMLED70	40 (104)	75 (167)	T6	T6	T6
		55 (131)	75 (167)	T6	T6	T6
		65 (143)	75 (167)	T6	T6	T6
100 Watt	CMLED10	40 (104)	75 (167)	T6	T6	T6
		55 (131)	75 (167)	T6	T6	T6
		65 (143)	75 (167)	T6	T6	T6
150 Watt	CMLED15	40 (104)	75 (167)	T6	T6	T6
		55 (131)	75 (167)	T6	T6	T6
175 Watt	CMLED17	40 (104)	75 (167)	T6	T6	T6
		50 (122)	75 (167)	T6	T6	T6
250 Watt	CMLED25	40 (104)	75 (167)	T6	T6	T6
		50 (122)	75 (167)	T6	T6	T6
350 Watt	CMLED35	40 (104)	75 (167)	T6	T6	T6
		50 (122)	75 (167)	T6	T6	T6
400 Watt	CMLED40	40 (104)	75 (167)	T6	T6	T6
		55 (131)	75 (167)	T6	T6	T6

“T” Numbers Represent the Maximum Surface Temperature for Class I, Division 1 locations and Maximum Surface Temperature Under Dust Blanket for Class II, Division 1 Locations.

“T” #	T1	350	325	T2	T2A	T2B	T2C	T2D	T3	T3A	T3B	T3C	T4	T4A	T5	T6
Temp. Range °C (°F)	351-450 (664-842)	326-350 (619-662)	301-325 (574-617)	281-300 (538-572)	261-280 (502-536)	231-260 (448-500)	216-230 (421-446)	201-215 (394-419)	181-200 (358-392)	166-180 (331-356)	161-165 (322-329)	136-160 (277-320)	121-135 (250-275)	101-120 (214-248)	86-100 (187-212)	85 (185)

★ Complete Code•Master LED luminaire consists of fixture unit and a mounting hood. For Group B applications a Group B rated mounting hood must be used.
 * Use of a fuse voids Marine Outside Type (Salt Water) rating.

Code•Master™ LED Factory Sealed Luminaires

Explosionproof, Dust-Ignitionproof

NEC/CEC:
 Class I, Division 1 and 2, Groups B, C, D ★
 Class I, Zone 1, Group IIB + H₂
 Class II, Division 1, Group E, F, G
 Class II, Division 2, Group F, G
 Class III

NEC/CEC:
 Simultaneous Exposure
 Type 3R, 4X
 IP66/67
 Suitable for Use in Wet Locations
 Marine Outside Type (Salt Water) *

Lamp Comparison Chart

Lamp Data	Line Current Amps	Input Power	Lumens	CRI	Lamp Life (Hours)	Color Temp CCT
NEMA Type V						
CMLED70	0.31 @ 120V	37	2582	70	60,000+	5650
	0.17 @ 277V	47				
	0.24 @ 347V	83				
	0.11 @ 480V	52				
CMLED10	0.41 @ 120V	49	3967	70	60,000+	5650
	0.20 @ 277V	55				
	0.25 @ 347V	86				
	0.12 @ 480V	57				
CMLED15	0.53 @ 120V	64	4838	70	60,000+	5650
	0.25 @ 277V	69				
	0.29 @ 347V	98				
	0.14 @ 480V	67				
CMLED17	0.64 @ 120V	77	6294	70	60,000+	5650
	0.28 @ 277V	78				
	0.25 @ 347V	86				
	0.16 @ 480V	88				
CMLED25	0.90 @ 120V	108	8982	70	60,000+	5650
	0.36 @ 277V	100				
	0.45 @ 347V	96				
	0.31 @ 480V	95				
CMLED35	0.32 @ 347V	111	11830	70	60,000+	5650
	0.23 @ 480V	110				
CMLED40	1.05 @ 120V	126	13732	70	60,000+	5650
	0.47 @ 277V	130				

★ Complete Code•Master LED luminaire consists of fixture unit and a mounting hood. For Group B applications a Group B rated mounting hood must be used.



* Use of a fuse voids Marine Outside Type (Salt Water) rating.

Code•Master™ LED Factory Sealed Luminaires

Explosionproof, Dust-Ignitionproof

NEC/CEC:
 Class I, Division 1 and 2, Groups B, C, D ★
 Class I, Zone 1, Group IIB + H₂
 Class II, Division 1, Group E, F, G
 Class II, Division 2, Group F, G
 Class III

NEC/CEC:
 Simultaneous Exposure
 Type 3R, 4X
 IP66/67
 Suitable for Use in Wet Locations
 Marine Outside Type (Salt Water) *

	LED Wattage	Lamp Wattage Equivalent	Hub Size	Catalog Number		Voltage Suffix ①②		
				Clear Glass		120–277 Vac	347–480 Vac	
Pendant — One Hub, Rigid or Flexible Mounting — 50/60 Hz								
	35/33 W	70 W HPS/PSMH	3/4	CMLEDA702G5		BU	BH	
	47.5/46 W	100 W HPS/PSMH	3/4	CMLEDA102G5		BU	BH	
	61/62 W	150 W HPS/PSMH	3/4	CMLEDA152G5		BU	BH	
	74/72 W	175 W PSMH	3/4	CMLEDA172G5		BU	BH	
	95.5/92 W	250 W HPS/MH	3/4	CMLEDA252G5		BU	BH	
	102/103 W	350 W PSMH	3/4	CMLEDA352G5		—	BH	
	127/128 W	400 W HPS/PSMH	3/4	CMLEDA402G5		BU	—	
	35/33 W	70 W HPS/PSMH	1	CMLEDA703G5		BU	BH	
	47.5/46 W	100 W HPS/PSMH	1	CMLEDA103G5		BU	BH	
	61/62 W	150 W HPS/PSMH	1	CMLEDA153G5		BU	BH	
	74/72 W	175 W PSMH	1	CMLEDA173G5		BU	BH	
	95.5/92 W	250 W HPS/MH	1	CMLEDA253G5		BU	BH	
	102/103 W	350 W PSMH	1	CMLEDA353G5		—	BH	
	127/128 W	400 W HPS/PSMH	1	CMLEDA403G5		BU	—	
	Ceiling — Four Hubs, Three Close-up Plugs — 50/60 Hz							
		35/33 W	70 W HPS/PSMH	3/4	CMLEDC702G5		BU	BH
47.5/46 W		100 W HPS/PSMH	3/4	CMLEDC102G5		BU	BH	
61/62 W		150 W HPS/PSMH	3/4	CMLEDC152G5		BU	BH	
74/72 W		175 W PSMH	3/4	CMLEDC172G5		BU	BH	
95.5/92 W		250 W HPS/MH	3/4	CMLEDC252G5		BU	BH	
102/103 W		350 W PSMH	3/4	CMLEDC352G5		—	BH	
127/128 W		400 W HPS/PSMH	3/4	CMLEDC402G5		BU	—	
35/33 W		70 W HPS/PSMH	1	CMLEDC703G5		BU	BH	
47.5/46 W		100 W HPS/PSMH	1	CMLEDC103G5		BU	BH	
61/62 W		150 W HPS/PSMH	1	CMLEDC153G5		BU	BH	
74/72 W		175 W PSMH	1	CMLEDC173G5		BU	BH	
95.5/92 W		250 W HPS/MH	1	CMLEDC253G5		BU	BH	
102/103 W		350 W PSMH	1	CMLEDC353G5		—	BH	
127/128 W		400 W HPS/PSMH	1	CMLEDC403G5		BU	—	

① For optional fusing, add suffix **-F** to the end of the catalog number. The Canadian Electrical Code does NOT allow fusing in hazardous locations. Fuse not CEC rated.

② For optional safety cable, add suffix **-C** to the end of the catalog number.
 For optional lens guard, add suffix **-G** to the end of the catalog number.

★ Complete Code•Master LED luminaire consists of fixture unit and a mounting hood. For Group B applications a Group B rated mounting hood must be used.

* Use of a fuse voids Marine Outside Type (Salt Water) rating.

◆ Shaded items are suitable for Class I, Group D ONLY.

LED/AREA: NEC/CEC EXPLOSIONPROOF/ATEX/IECEX FLAMEPROOF

Appleton



Code•Master™ LED Factory Sealed Luminaires

Explosionproof, Dust-Ignitionproof

NEC/CEC:
Class I, Division 1 and 2, Groups B, C, D ★
Class I, Zone 1, Group IIB + H₂
Class II, Division 1, Group E, F, G
Class II, Division 2, Group F, G
Class III

NEC/CEC:
Simultaneous Exposure
Type 3R, 4X
IP66/67
Suitable for Use in Wet Locations
Marine Outside Type (Salt Water) *

LED/AREA: NEC/CEC EXPLOSIONPROOF/ATEX/IECEx FLAMEPROOF

	LED Wattage	Lamp Wattage Equivalent	Hub Size	Catalog Number		Voltage Suffix ①②		
				Clear Glass		120–277 Vac	347–480 Vac	
Wall — Four Hubs, Three Close-up Plugs — 50/60 Hz								
	35/33 W	70 W HPS/PSMH	3/4	CMLEDW702G5		BU	BH	
	47.5/46 W	100 W HPS/PSMH	3/4	CMLEDW102G5		BU	BH	
	61/62 W	150 W HPS/PSMH	3/4	CMLEDW152G5		BU	BH	
	74/72 W	175 W PSMH	3/4	CMLEDW172G5		BU	BH	
	95.5/92 W	250 W HPS/MH	3/4	CMLEDW252G5		BU	BH	
	102/103 W	350 W PSMH	3/4	CMLEDW352G5		—	BH	
	127/128 W	400 W HPS/PSMH	3/4	CMLEDW402G5		BU	—	
	35/33 W	70 W HPS/PSMH	1	CMLEDW703G5		BU	BH	
	47.5/46 W	100 W HPS/PSMH	1	CMLEDW103G5		BU	BH	
	61/62 W	150 W HPS/PSMH	1	CMLEDW153G5		BU	BH	
	74/72 W	175 W PSMH	1	CMLEDW173G5		BU	BH	
	95.5/92 W	250 W HPS/MH	1	CMLEDW253G5		BU	BH	
	102/103 W	350 W PSMH	1	CMLEDW353G5		—	BH	
	127/128 W	400 W HPS/PSMH	1	CMLEDW403G5		BU	—	
	25° Stanchion — One Hub — 50/60 Hz							
		35/33 W	70 W HPS/PSMH	1-1/4	CMLEDS704G5		BU	BH
47.5/46 W		100 W HPS/PSMH	1-1/4	CMLEDS104G5		BU	BH	
61/62 W		150 W HPS/PSMH	1-1/4	CMLEDS154G5		BU	BH	
74/72 W		175 W PSMH	1-1/4	CMLEDS174G5		BU	BH	
95.5/92 W		250 W HPS/MH	1-1/4	CMLEDS254G5		BU	BH	
102/103 W		350 W PSMH	1-1/4	CMLEDS354G5		—	BH	
127/128 W		400 W HPS/PSMH	1-1/4	CMLEDS404G5		BU	—	
35/33 W		70 W HPS/PSMH	1-1/2	CMLEDS705G5		BU	BH	
47.5/46 W		100 W HPS/PSMH	1-1/2	CMLEDS105G5		BU	BH	
61/62 W		150 W HPS/PSMH	1-1/2	CMLEDS155G5		BU	BH	
74/72 W		175 W PSMH	1-1/2	CMLEDS175G5		BU	BH	
95.5/92 W		250 W HPS/MH	1-1/2	CMLEDS255G5		BU	BH	
102/103 W		350 W PSMH	1-1/2	CMLEDS355G5		—	BH	
127/128 W		400 W HPS/PSMH	1-1/2	CMLEDS405G5		BU	—	

① For optional fusing, add suffix **-F** to the end of the catalog number. The Canadian Electrical Code does NOT allow fusing in hazardous locations. Fuse not CEC rated.

② For optional safety cable, add suffix **-C** to the end of the catalog number.

For optional lens guard, add suffix **-G** to the end of the catalog number.

★ Complete Code•Master LED luminaire consists of fixture unit and a mounting hood. For Group B applications a Group B rated mounting hood must be used.

* Use of a fuse voids Marine Outside Type (Salt Water) rating.

◆ Shaded items are suitable for Class I, Group D ONLY.

Code•Master™ LED Factory Sealed Luminaires

Explosionproof, Dust-Ignitionproof

NEC/CEC:
 Class I, Division 1 and 2, Groups B, C, D ★
 Class I, Zone 1, Group IIB + H₂
 Class II, Division 1, Group E, F, G
 Class II, Division 2, Group F, G
 Class III

NEC/CEC:
 Simultaneous Exposure
 Type 3R, 4X
 IP66/67
 Suitable for Use in Wet Locations
 Marine Outside Type (Salt Water) *

Fixture Unit — Electrical Specification



LED Wattage BU/BH	Light Level Equivalent	Voltage Range	Current Draw	Catalog Number Glass Globe	Voltage Suffix
35/33 W	70 W HPS	120-277 Vac, 50/60 Hz	120 Vac @ .31 Amps 277 Vac @ .17 Amps	CMLED70G5	BU
34/32 W	70 W HPS	347-480 Vac, 50/60 Hz	347 Vac @ .32 Amps 480 Vac @ .23 Amps	CMLED70G5	BH
47.5/46 W	100 W HPS	120-277 Vac, 50/60 Hz	120 Vac @ .41 Amps 277 Vac @ .20 Amps	CMLED10G5	BU
42/44 W	100 W HPS	347-480 Vac, 50/60 Hz	347 Vac @ .32 Amps 480 Vac @ .23 Amps	CMLED10G5	BH
61/62 W	150 W HPS	120-277 Vac, 50/60 Hz	120 Vac @ .53 Amps 277 Vac @ .25 Amps	CMLED15G5	BU
62/64 W	150 W HPS	347-480 Vac, 50/60 Hz	347 Vac @ .32 Amps 480 Vac @ .25 Amps	CMLED15G5	BH
74/72 W	175 W PSMH	120-277 Vac, 50/60 Hz	120 Vac @ .63 Amps 277 Vac @ .28 Amps	CMLED17G5	BU
86/88 W	175 W PSMH	347-480 Vac, 50/60 Hz	347 Vac @ .32 Amps 480 Vac @ .23 Amps	CMLED17G5	BH
95.5/92 W	250 W HPS/PSMH	120-277 Vac, 50/60 Hz	120 Vac @ .90 Amps 277 Vac @ .36 Amps	CMLED25G5	BU
96/95 W	250 W HPS/PSMH	347-480 Vac, 50/60 Hz	347 Vac @ .32 Amps 480 Vac @ .23 Amps	CMLED25G5	BH
102/103 W	350 W PSMH	347-480 Vac, 50/60 Hz	347 Vac @ .33 Amps 480 Vac @ .23 Amps	CMLED35G5	BH
127/128 W	400 W HPS/PSMH	120-277 Vac, 50/60 Hz	120 Vac @ 1.18 Amps 277 Vac @ .47 Amps	CMLED40G5	BU

★ Complete Code•Master LED luminaire consists of fixture unit and a mounting hood. For Group B applications a Group B rated mounting hood must be used.
 * Use of a fuse voids Marine Outside Type (Salt Water) rating.

Code•Master™ LED Factory Sealed Luminaires







Explosionproof, Dust-Ignitionproof

NEC/CEC:
 Class I, Division 1 and 2, Groups B, C, D ★
 Class I, Zone 1, Group IIB + H₂
 Class II, Division 1, Group E, F, G
 Class II, Division 2, Group F, G
 Class III

NEC/CEC:
 Simultaneous Exposure
 Type 3R, 4X
 IP66/67
 Suitable for Use in Wet Locations
 Marine Outside Type (Salt Water) *

LED/AREA: NEC/CEC EXPLOSIONPROOF/ATEX/IECEx FLAMEPROOF

Mounting Hoods

			Certified for Class I, Division 1 and 2, Group			
			Hub Size Inches	cCSA Certified	cCSAus Certified	Catalog Number
Pendant						
 CAP-75 & CAP-100	 CAP-75B	One Hub	3/4	B, C, D	C, D	CAP-75
			3/4	B, C, D	B, C, D	CAP-75B
			1	D	D	CAP-100
Ceiling						
	Four hubs, Three Close-Up Plugs		3/4	C, D	C, D	CAC-75
			1	D	D	CAC-100
Bracket						
	Four hubs, Three Close-Up Plugs		3/4	C, D	C, D	CALB-75
			1	D	D	CALB-100
25° Stanchion						
 CAS-150	 CAS-150B	One Hub	1-1/4 or 1-1/2 ①	B, C, D	C, D	CAS-150
			1-1/2	B, C, D	B, C, D	CAS-150B

① 1-1/2" tapped hub furnished with 1-1/2" to 1-1/4" reducer.

★ Complete Code•Master LED luminaire consists of fixture unit and a mounting hood. For Group B applications a Group B rated mounting hood must be used.

* Use of a fuse voids Marine Outside Type (Salt Water) rating.

◆ Shaded items are suitable for Class I, Group D ONLY.







Code•Master™ LED Factory Sealed Luminaires

Explosionproof, Dust-Ignitionproof

NEC/CEC:
 Class I, Division 1 and 2, Groups B, C, D ★
 Class I, Zone 1, Group IIB + H₂
 Class II, Division 1, Group E, F, G
 Class II, Division 2, Group F, G
 Class III

NEC/CEC:
 Simultaneous Exposure
 Type 3R, 4X
 IP66/67
 Suitable for Use in Wet Locations
 Marine Outside Type (Salt Water) *

Accessories and Replacement Parts

	Description	Catalog Number
Fuse Kits *		
	3 Amp for 120-277 Vac, 70 thru 250 Watt Equivalent	CMLEDF-3
	5 Amp for 120-277 Vac, 400 Watt Equivalent	CMLEDF-5
	2 Amp for 347-480 Vac, 70 thru 350 Watt Equivalent	CMLEDF-2
Globes and Gaskets		
	Clear Globe Assembly	CGL-CLEAR
	Stainless Steel Wire Guard	CMLEDGU
	Safety Cable	CMLEDSC
LED Array		
	70 Watt Equivalent LED Array Assembly, Type V, White LED's	CMLED70A5W
	100 Watt Equivalent LED Array Assembly, Type V, White LED's	CMLED10A5W
	150 Watt Equivalent LED Array Assembly, Type V, White LED's	CMLED15A5W
	175 Watt Equivalent LED Array Assembly, Type V, White LED's	CMLED17A5W
	250 Watt Equivalent LED Array Assembly, Type V, White LED's	CMLED25A5W
	350 Watt Equivalent LED Array Assembly, Type V, White LED's	CMLED35A5W
	400 Watt Equivalent LED Array Assembly, Type V, White LED's	CMLED40A5W
Drivers		
	120-277 V Driver (70 thru 250 Watt equivalent only)	CMLEDBU
	347-480 V Driver (70 thru 350 Watt equivalent only)	CMLEDBH
	120-277 V Driver (400 Watt equivalent only)	CMLEDBU40

★ Complete Code•Master LED luminaire consists of fixture unit and a mounting hood. For Group B applications a Group B rated mounting hood must be used.
 * Use of a fuse voids Marine Outside Type (Salt Water) rating.
 The Canadian Electrical Code does NOT allow fusing in hazardous locations. Fuse not CEC rated.

Code•Master™ LED Factory Sealed Luminaires

Explosionproof, Dust-Ignitionproof

NEC/CEC:

Class I, Division 1 and 2, Groups B, C, D ★
 Class I, Zone 1, Group IIB + H₂
 Class II, Division 1, Group E, F, G
 Class II, Division 2, Group F, G
 Class III

NEC/CEC:

Simultaneous Exposure
 Type 3R, 4X
 IP66/67
 Suitable for Use in Wet Locations
 Marine Outside Type (Salt Water) *

Dimensions in Millimeters (Inches)

LED/AREA: NEC/CEC EXPLOSIONPROOF/ATEX/IECEx FLAMEPROOF

Pendant

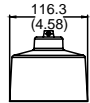

Ceiling

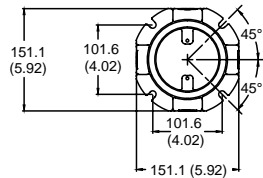

Bracket

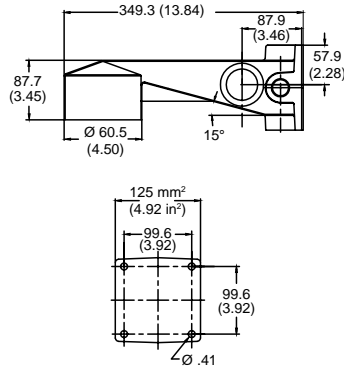

25° Stanchion

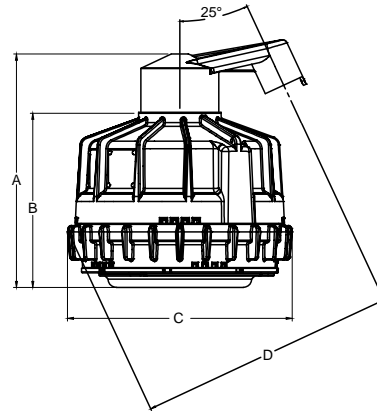
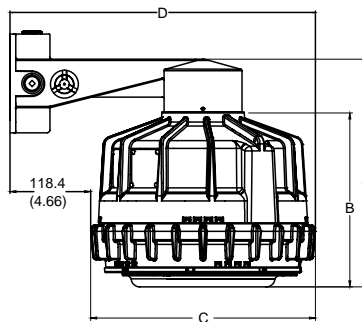
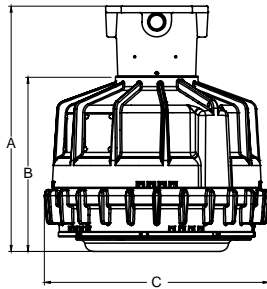
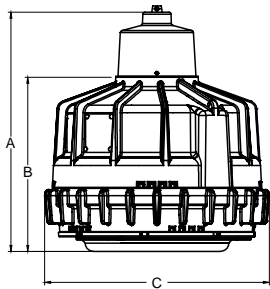
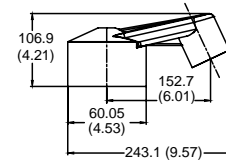

Pendant			Ceiling			Bracket				25° Stanchion			
A	B	C	A	B	C	A	B	C	D	A	B	C	D
350.5	256.5	330.2	360.7	256.5	330.2	335.3	256.5	330.2	449.6	365.8	256.5	330.2	378.5
(13.8)	(10.1)	(13.0)	(14.2)	(10.1)	(13.0)	(13.2)	(10.1)	(13.0)	(17.7)	(14.4)	(10.1)	(13.0)	(14.9)

Wire Guard

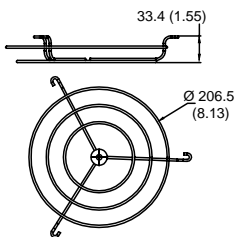

Weights

Description	Weight kg (lb)
Fixture Unit (Ballast Housing)	17.2 (38)
Pendant Mounting Hood	0.9 (2)
Ceiling Mounting Hood	1.8 (4)
Wall Mounting Hood	2.7 (6)
25° Stanchion Mounting Hood	0.9 (2)
Wire Guard	0.45 (1)

★ Complete Code•Master LED luminaire consists of fixture unit and a mounting hood. For Group B applications a Group B rated mounting hood must be used.
 ★ Use of a fuse voids Marine Outside Type (Salt Water) rating.

Code•Master™ LED Factory Sealed Luminaires

Explosionproof, Dust-Ignitionproof

NEC/CEC:

Class I, Division 1 and 2, Groups B, C, D ★
 Class I, Zone 1, Group IIB + H₂
 Class II, Division 1, Group E, F, G
 Class II, Division 2, Group F, G
 Class III

NEC/CEC:

Simultaneous Exposure
 Type 3R, 4X
 IP66/67
 Suitable for Use in Wet Locations
 Marine Outside Type (Salt Water) *

Photometric Data – DATA SHOWN IS ABSOLUTE

REPORT NUMBER: **CMLED70P5BU**

Lamps: Code•Master LED with clear glass globe, pendant style mount.
 Total Input Watts = 34.1. Efficacy= 75.7 Lm/W. CIE Type – Direct.

Candela Distribution

	0.0	22.5	45.0	67.5	90.0	Flux
0	1322	1322	1322	1322	1322	
5	1301	1304	1304	1308	1304	123
15	1229	1236	1244	1260	1271	353
25	1213	1172	1128	1137	1137	528
35	958	917	955	921	882	577
45	673	685	686	689	653	524
55	422	428	404	367	349	351
65	124	106	96	118	120	113
75	5	5	7	7	8	11
85	3	2	1	1	1	2
90	1	1	1	1	1	

Zonal Lumen Summary

Zone	Lumens	% Fixture
0-30	1004	38.9
0-40	1581	61.2
0-60	2456	95.1
0-90	2581	100.0

CIE Type – Direct

Plane	Spacing Criteria
0-Deg	90-Deg
1.2	1.2

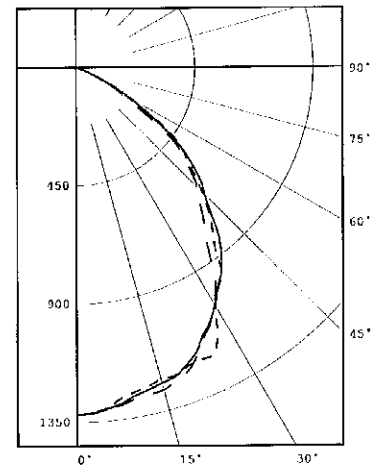

REPORT NUMBER: **CMLED10P5BU**

Lamps: Code•Master LED with clear glass globe, pendant style mount.
 Total Input Watts = 46.8. Efficacy= 84.8 Lm/W. CIE Type – Direct.

Candela Distribution

	0.0	22.5	45.0	67.5	90.0	Flux
0	1999	1999	1999	1999	1999	
5	1983	1974	1982	1976	1976	187
15	1886	1888	1890	1882	1885	533
25	1724	1739	1776	1773	1716	803
35	1503	1372	1403	1449	1440	884
45	1081	1029	1013	1082	1035	806
55	573	581	624	655	662	549
65	194	177	193	165	131	183
75	12	11	8	10	11	18
85	2	2	2	2	2	3
90	2	1	2	2	2	

Zonal Lumen Summary

Zone	Lumens	% Fixture
0-30	1523	38.4
0-40	2408	60.7
0-60	3762	94.8
0-90	3966	100.0

CIE Type – Direct

Plane	Spacing Criteria
0-Deg	90-Deg
1.2	1.2

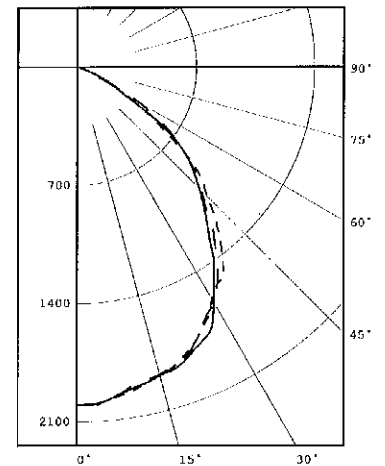

★ Complete Code•Master LED luminaire consists of fixture unit and a mounting hood. For Group B applications a Group B rated mounting hood must be used.
 * Use of a fuse voids Marine Outside Type (Salt Water) rating.

Code•Master™ LED Factory Sealed Luminaires

Explosionproof, Dust-Ignitionproof

NEC/CEC:

Class I, Division 1 and 2, Groups B, C, D ★
 Class I, Zone 1, Group IIB + H₂
 Class II, Division 1, Group E, F, G
 Class II, Division 2, Group F, G
 Class III

NEC/CEC:

Simultaneous Exposure
 Type 3R, 4X
 IP66/67
 Suitable for Use in Wet Locations
 Marine Outside Type (Salt Water) *

Photometric Data – DATA SHOWN IS ABSOLUTE

REPORT NUMBER: **CMLED15P5BU**

Lamps: Code•Master LED with clear glass globe, pendant style mount.
 Total Input Watts = 59.3. Efficacy= 81.6 Lm/W. CIE Type – Direct.

Candela Distribution

	0.0	22.5	45.0	67.5	90.0	Flux
0	2400	2400	2400	2400	2400	
5	2376	2374	2376	2379	2379	225
15	2298	2282	2276	2270	2253	644
25	2105	2090	2146	2145	2094	971
35	1775	1709	1692	1758	1697	1075
45	1388	1245	1253	1302	1231	983
55	724	715	763	795	807	675
65	233	214	243	219	200	233
75	17	18	13	17	21	27
85	3	2	2	2	2	
90	2	2	2	2	2	1

Zonal Lumen Summary

Zone	Lumens	% Fixture
0-30	1840	38.0
0-40	2915	60.3
0-60	4573	94.5
0-90	4837	100.0

CIE Type – Direct

Plane	Spacing Criteria
0-Deg	90-Deg
1.2	1.2

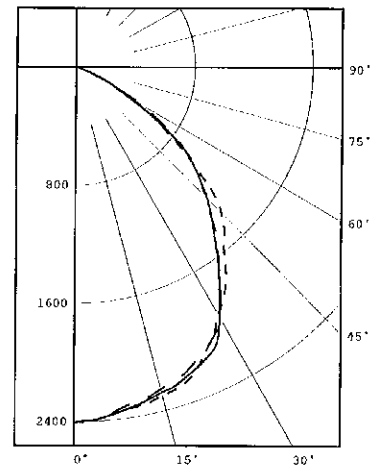

REPORT NUMBER: **CMLED17P5BU**

Lamps: Code•Master LED with clear glass globe, pendant style mount.
 Total Input Watts = 73.0. Efficacy= 86.2 Lm/W. CIE Type – Direct.

Candela Distribution

	0.0	22.5	45.0	67.5	90.0	Flux
0	3260	3260	3260	3260	3260	
5	3218	3222	3228	3230	3238	306
15	3071	3094	3107	3114	3105	874
25	2778	2869	2864	2796	2810	1294
35	2260	2314	2223	2199	2370	1413
45	1708	1718	1651	1642	1712	1286
55	905	923	915	910	902	814
65	207	237	265	241	260	253
75	40	38	32	30	31	42
85	7	7	6	5	5	9
90	4	4	4	4	4	

Zonal Lumen Summary

Zone	Lumens	% Fixture
0-30	2475	39.3
0-40	3887	61.8
0-60	5988	95.1
0-90	6292	100.0

CIE Type – Direct

Plane	Spacing Criteria
0-Deg	90-Deg
1.2	1.2

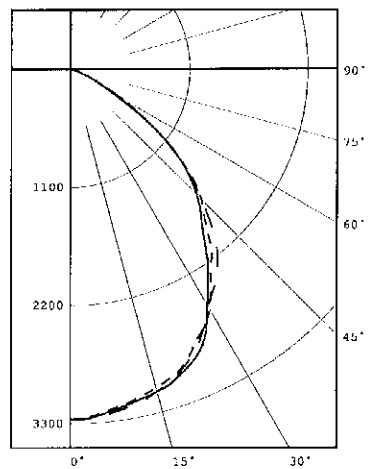

★ Complete Code•Master LED luminaire consists of fixture unit and a mounting hood. For Group B applications a Group B rated mounting hood must be used.
 * Use of a fuse voids Marine Outside Type (Salt Water) rating.

Code•Master™ LED Factory Sealed Luminaires

Explosionproof, Dust-Ignitionproof

NEC/CEC:
 Class I, Division 1 and 2, Groups B, C, D ★
 Class I, Zone 1, Group IIB + H₂
 Class II, Division 1, Group E, F, G
 Class II, Division 2, Group F, G
 Class III

NEC/CEC:
 Simultaneous Exposure
 Type 3R, 4X
 IP66/67
 Suitable for Use in Wet Locations
 Marine Outside Type (Salt Water) *

Photometric Data – DATA SHOWN IS ABSOLUTE

REPORT NUMBER: **CMLED25P5BU**

Lamps: Code•Master LED with clear glass globe, pendant style mount.
 Total Input Watts = 97.6. Efficacy= 92.0 Lm/W. CIE Type – Direct.

Candela Distribution						
	0.0	22.5	45.0	67.5	90.0	Flux
0	4239	4239	4239	4239	4239	
5	4208	4209	4202	4203	4198	397
15	3991	4008	3999	4017	4033	1138
25	3843	3848	3904	3873	3768	1766
35	3139	3208	3071	3127	3302	1976
45	2282	2394	2303	2288	2526	1816
55	1574	1537	1524	1485	1453	1340
65	454	438	464	439	487	483
75	41	33	26	33	33	55
85	7	7	7	7	8	9
90	5	5	5	5	5	

Zonal Lumen Summary		
Zone	Lumens	% Fixture
0-30	3301	36.7
0-40	5276	58.7
0-60	8432	93.9
0-90	8979	100.0

CIE Type – Direct	
Plane	Spacing Criteria
0-Deg	90-Deg
1.2	1.2

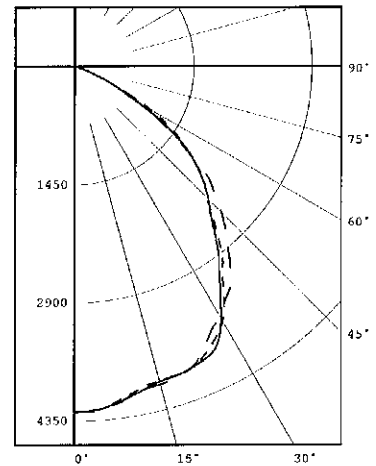

REPORT NUMBER: **CMLED35P5BU**

Lamps: Code•Master LED with clear glass globe, pendant style mount.
 Total Input Watts = 104.0. Efficacy= 113.8 Lm/W. CIE Type – Direct.

Candela Distribution						
	0.0	22.5	45.0	67.5	90.0	Flux
0	4773	4773	4773	4773	4773	
5	4771	4772	4771	4766	4787	454
15	4717	4716	4735	4719	4745	1340
25	4656	4585	4613	4632	4601	2138
35	4337	4026	4181	4248	3858	2545
45	2941	3019	3042	2983	2996	2338
55	2495	2375	2289	2311	2409	2073
65	831	782	855	873	765	868
75	38	34	35	34	30	58
85	9	10	9	10	11	12
90	6	7	6	7	6	

Zonal Lumen Summary		
Zone	Lumens	% Fixture
0-30	3932	33.2
0-40	6477	54.7
0-60	10888	92.0
0-90	11826	100.0

CIE Type – Direct	
Plane	Spacing Criteria
0-Deg	90-Deg
1.4	1.3

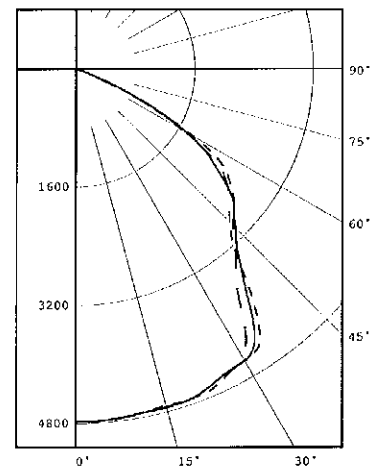

★ Complete Code•Master LED luminaire consists of fixture unit and a mounting hood. For Group B applications a Group B rated mounting hood must be used.
 * Use of a fuse voids Marine Outside Type (Salt Water) rating.

Code•Master™ LED Factory Sealed Luminaires

Explosionproof, Dust-Ignitionproof

NEC/CEC:

Class I, Division 1 and 2, Groups B, C, D ★
 Class I, Zone 1, Group IIB + H₂
 Class II, Division 1, Group E, F, G
 Class II, Division 2, Group F, G
 Class III

NEC/CEC:

Simultaneous Exposure
 Type 3R, 4X
 IP66/67
 Suitable for Use in Wet Locations
 Marine Outside Type (Salt Water) *

Photometric Data – DATA SHOWN IS ABSOLUTE

REPORT NUMBER: **CMLED40P5BU**

Lamps: Code•Master LED with clear glass globe, pendant style mount.
 Total Input Watts = 127.9. Efficacy= 107.4 Lm/W. CIE Type – Direct.

Candela Distribution

	0.0	22.5	45.0	67.5	90.0	Flux
0	5525	5525	5525	5525	5525	
5	5535	5543	5523	5517	5509	526
15	5480	5503	5474	5467	5466	1553
25	5392	5370	5354	5365	5362	2483
35	4789	4730	4805	4940	4610	2947
45	3454	3494	3490	3434	3506	2724
55	2643	2686	2699	2858	2886	2425
65	1149	950	868	1000	806	992
75	37	42	41	38	35	62
85	11	11	10	10	10	13
90	9	8	7	7	7	

Zonal Lumen Summary

Zone	Lumens	% Fixture
0-30	4562	33.2
0-40	7509	54.7
0-60	12659	92.2
0-90	13727	100.0

CIE Type – Direct

Plane	Spacing Criteria
0-Deg	90-Deg
1.4	1.3

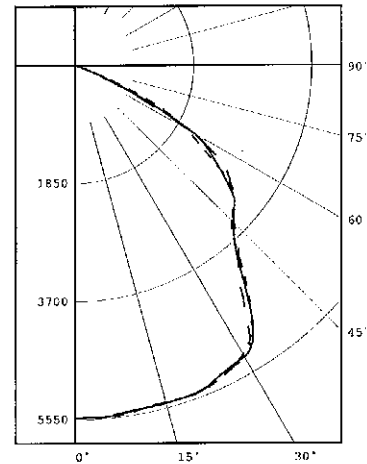

LED/AREA: NEC/CEC EXPLOSIONPROOF/ATEX/IECEx FLAMEPROOF

Appleton

★ Complete Code•Master LED luminaire consists of fixture unit and a mounting hood. For Group B applications a Group B rated mounting hood must be used.
 ★ Use of a fuse voids Marine Outside Type (Salt Water) rating.

ATX™ FDLED Series Luminaires

Flameproof

ATEX/IECEX:
Zone 1 and 2 - 21 and 22
⊕ II 2GD
Ex d IIB (4725 lm version)
Ex d IIB+H₂ (2400 lm version)
Ex d IIC (400 lm version)

ATEX/IECEX:
IK09 (400 and 2400 lm version)
IK08 (4725 lm version)
IP66/68

Applications

- Can be installed in hazardous areas designated as Zone 1 and 2 – 21 and 22.
- For use in locations where a high degree of corrosion resistance is required.
- For indoor/outdoor use where protection against dirt, water and moisture is necessary.
- Typical applications include:
 - Oil refineries
 - Petrochemical facilities
 - Pulp and paper, mills
 - Painting, sewage and water treatment facilities
 - Warehouses
 - Underground tunnels
 - General manufacturing facilities.

Features

- Impact resistant borosilicate glass sealed tube.
- Easy access to LED array through gray painted aluminum threaded entry cap.
- Supplied with O-ring for improved ingress protection.
- Corrosion-resistant gray painted aluminum.
- Supplied with energy efficient electronic driver on a removable gear tray.
- Supplied with external and internal ground/earth connection.
- Fixture supplied with one M20 blanking plug.
- Easy connection to wire and disconnect with plug-in terminal blocks.

Standard Materials

- End caps and cover: aluminum.
- Glass tube: tempered borosilicate glass.
- O-ring gasket: Nitrile (NBR).
- Internal reflector: white powder coated galvanized steel (400 lm version) or aluminium (2400/4725 lm versions).
- Mounting accessories: several accessories in different material such as zinc plated steel, galvanized steel or 316 stainless steel.

Options

- Diffused polycarbonate lens (2400/4725 lm versions only)
- Ta -50 °C (-58 °F) IP66 (without gasket)
- Ta -40 °C (-40 °F) IP66/68 (with EPDM70)

ATEX/IECEX Certifications and Compliances

- Certification Type FDLED
 - Gas: Zone 1 and 2:
 - Conforming to ATEX 94/9/CE: ⊕ II 2 G
 - Type of Protection: Ex d IIB (4725 lm version), Ex d IIB+H₂ (2400 lm version), Ex d IIC (400 lm version)
 - Temperature Class: T6
 - Dust: Zone 21 and 22:
 - Conforming to ATEX 94/9/CE: ⊕ II 2 D
 - Type of Protection: Ex tb IIIC
 - Surface Temperature:
 - +75 °C (+167 °F) (400 lm version)
 - +80 °C (+176 °F) (2400 and 4725 lm version)
- Ambient Temperature: -30 °C to 60 °C (-22 °F to +140 °F)
- CE Declaration of Conformity: 50312
- ATEX Certificate: INERIS 15 ATEX 0042X
- IECEx Certificate: IECEx INE 15.0046X
- Index of Protection according EN/IEC 60529: IP66/68



4725 lm (IIB)



2400 lm (IIB+H₂)



400 lm (IIC)

- Impact Resistance (shock): IK09 (400 and 2400 lm version), IK08 (4725 lm version)
- Internal Volume: > 2 dm³ (122 in³) - 2 liters

LED/AREA: NEC/CFC EXPLOSIONPROOF/ATEX/IECEX FLAMEPROOF

Appleton®

ATX™ FDLED Series Luminaires

Flameproof

ATEX/IECEX:
 Zone 1 and 2 - 21 and 22
 IIC
 Ex d IIB (4725 lm version)
 Ex d IIB+H₂ (2400 lm version)
 Ex d IIC (400 lm version)

ATEX/IECEX:
 IK09 (400 and 2400 lm version)
 IK08 (4725 lm version)
 IP66/68

LED/AREA: NEC/CEC EXPLOSIONPROOF/ATEX/IECEX FLAMEPROOF

Catalog Numbering Guide – FD LED Series Luminaires

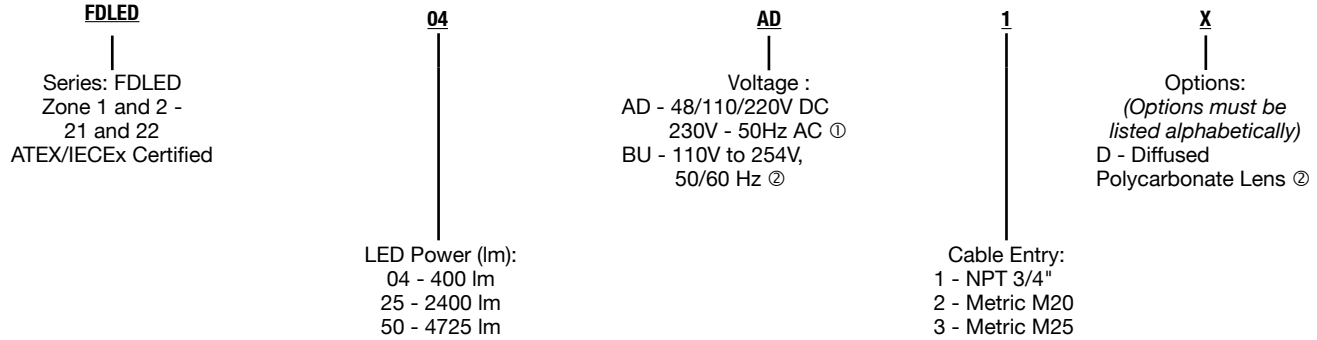

Technical Data

Lumen Output	Type	P	I _e	Gas group	Ambient Temperature °C (°F)	Class of Temperature	Surface Temperature °C (°F)
400 lm	LED	6 W	0.03 A	IIC	-30 °C to + 60°C (-22 °F to +140 °F)	T6	75 (167)
2400 lm	LED	23 W	0.21 A	IIB+H ₂	-30 °C to + 60°C (-22 °F to +140 °F)	T6	80 (176)
4725 lm	LED	46 W	0.42 A	IIB	-30 °C to + 60°C (-22 °F to +140 °F)	T6	80 (176)

Led Power (lm)	Voltage	Cable Entry	Weight kg (lb)	Volume dm ³ (in ³)	Catalog Number
400 lm	48/110/220V DC 230V - 50Hz AC	M20	7.8 (17.2)	36.0 (2196.9)	FDLED04AD2
2400 lm	110V to 254V, 50/60 Hz	M20	8.1 (17.9)	37.1 (2264.0)	FDLED25BU2
4725 lm	110V to 254V, 50/60 Hz	M20	9.0 (19.8)	58.0 (3539.4)	FDLED50BU2

① Only 400 lm version
 ② Only 2400 and 4725 lm version



ATX™ FDLED Series Luminaires

Flameproof

ATEX/IECEX:
Zone 1 and 2 - 21 and 22
 Ⓢ II2GD
 Ex d IIB (4725 lm version)
 Ex d IIB+H₂ (2400 lm version)
 Ex d IIC (400 lm version)

ATEX/IECEX:
IK09 (400 and 2400 lm version)
IK08 (4725 lm version)
IP66/68

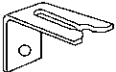
Accessories and Replacement Parts

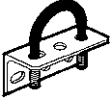
	Description	Catalog Number
Protective Guard – Zinc Plated Steel		
	Model 0.3 (for 400 lm)	FDPG1Z
	Model 0,4 (for 2400 lm)	FDPG5Z
	Model 0.6 (for 4725 lm)	FDPG2Z
Fixing Brackets for Ease of Surface Installation – Set of Two		
	Zinc plated steel	FDFBZ
	316 stainless steel	FDFBS
Surface Mounting Brackets – Set of Two		
	Zinc plated steel	FDSBZ
	316 stainless steel	FDSBS
Half Clamp Brackets for Pole Mounting – Set of Two		
	For 42 mm (1.65 in) to 49 mm (1.93 in) pole (1-1/4 to 1-1/2" tube)	
	Zinc plated steel	FDHC49Z
	316 stainless steel	FDHC49S
	For 60 mm (2.36 in) pole (2" tube)	
	Zinc plated steel	FDHC60Z
	316 stainless steel	FDHC60S
Fall Prevention Kit		
	1.20 meter (3.93 feet) stainless steel chain	FDSCS

Dimensions in Millimeters (Inches)

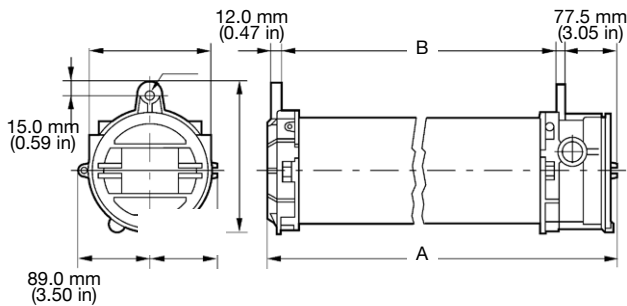

Model	A	B
0.3 (400 lm)	430 (16.93)	335 (13.19)
0,4 (2400 lm)	470 (18.50)	375 (14.76)
0.6 (4725 lm)	745 (29.33)	650 (25.59)

ATX™ DEMULED LED Series Luminaires

Flameproof

ATEX/IECEX:
Zone 1 and 2 - 21 and 22
Ex II 2GD
Ex tb IIIC
IK09
IP66/68

LED/AREA: NEC/CEC EXPLOSIONPROOF/ATEX/IECEX FLAMEPROOF

Applications

- Provides adequate lighting and/or visual indication of access on exit routes during an evacuation in a hazardous environment.
- Can be installed in hazardous areas designated as Zone 1 and 2 – 21 and 22.
- Typical applications include oil refineries, petrochemical plants, pulp and paper mills.

Features

All versions:

- Power supply 230 Vac, 50 Hz.
- 1 hour duration (emergency).
- Threaded access cover with O-ring seal.
- Battery pack :
Escape route lighting: 2.4 V - 0,8 Ah (2 cells - Nicd)
Space lighting: 6 V - 1,6 Ah (6 cells - Nicd)
- Charge indicator by 1 green LED (life time over 10 years).
- Operates in any position.
- Connection to plug-in terminal block via 5 x 2.5 mm² (0.004 in²) terminals.
- Supplied with two fixing brackets (zinc plated steel)
- Automatic built-in self-test system (SATI) with memorization of tests indicated by LEDs.
- Using a microprocessor and an internal clock, the unit will carry out automatic tests.
- Escape route lighting: 45 lumens, 0.50 wattage.
Space lighting: 400 lumens, 0.95 wattage.

Addressable versions:

- Operates without additional control lines. Communication between units and the control system is realized via mains borne signals that utilize the existing electrical wiring.
- Standard control system capacity: one control system for up to 200 emergency lighting units.
- Optional increased control system capacity: booster (repeater unit) is used to increase the length of the network allowing up to 1000 emergency lighting units to be on one control system. This allows for the use of a single computer to centralize the management of the facilities emergency lighting system. For more information, please contact your local sales representative

Standard Materials

- End caps and cover: aluminum
- O-ring seal: Nitrile
- Lens: tempered borosilicate glass tube
- Fixing brackets: zinc plated steel or 316 stainless steel
- Accessories: white painted galvanized steel
- Guard: zinc plated steel

Options

- Ta -40 °C (-40 °F) (with EPDM70)
- Addressable monitoring software, please consult your local sales representative.



ATEX/IECEX Certifications and Compliances

- Certification Type DEMULED
 - Gas: Zone 1 and 2:
 - Conforming to ATEX 94/9/CE: Ex II 2 G
 - Type of Protection: Ex d IIC
 - Temperature Class: T6
 - Dust: Zone 21 and 22:
 - Conforming to ATEX 94/9/CE: Ex II 2 D
 - Type of Protection: Ex tb IIIC
 - Surface Temperature: +75 °C (167 °F)
- Ambient Temperature: -30 °C to +55 °C (-22 °F to +131 °F) ①
- CE Declaration of Conformity: 50314
- ATEX Certificate: INERIS 15ATEX0056X
- IECEx Certificate: IECEx INE 15.0052X
- Index of Protection according EN/IEC 60529: IP66/68 (10m/1h)
- Impact Resistance (shock): IK09
- Internal Volume: > 2 dm³ (122 in³) - 2 liters
- Conforming to NF AEAS

Related Products

- For labels see *Labels for Emergency Lighting Units, ATX Self-Adhesive Signaling Labels for Emergency Lighting Units.*

① Optimum operating temperature for battery is -5 °C to +30 °C (-22 °F to +131 °F).

ATX™ DEMULED LED Series Luminaires

Flameproof



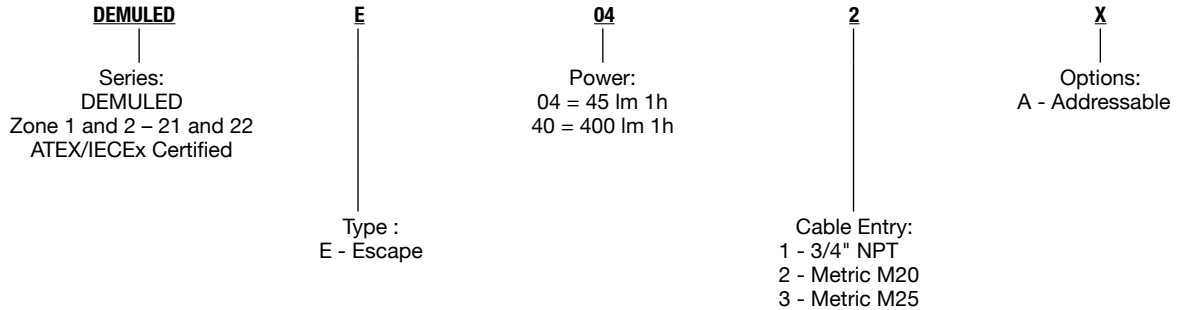

ATEX/IECEX:
 Zone 1 and 2 - 21 and 22
 II2GD
 Ex tb IIIC
 IK09
 IP66/68

Catalog Numbering Guide

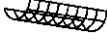

Type	Lamp	Lumen Output	Cable Entries	Weight kg (lb)	Volume dm ³ (in ³)	Option	Catalog Number
Escape	LED	45 lm	M20	7.8 (17.2)	36.0 (2196.9)	SATI	DEMULEDE042
Escape	LED	45 lm	M20	7.8 (17.2)	36.0 (2196.9)	Addressable	DEMULEDE042A

Accessories and Replacement Parts

	Description	Catalog Number
	Protective Guard Zinc plated steel	FDPG1Z
	Fixing Brackets: Set of two for ease of surface installation Zinc plated steel 316 stainless steel	FDFBZ FDFBS
	Surface Mounting Brackets: Set of two Zinc plated steel 316 stainless steel	FDSBZ FDSBS
	Half Clamps: Set of two Zinc plated steel versions: For 42 mm to 49 mm pole (1-1/4 to 1-1/2" tube) For 60 mm pole (2" tube) 316 stainless steel versions: For 42 mm to 49 mm pole (1-1/4 to 1-1/2" tube) For 60 mm pole (2" tube)	FDHC49Z FDHC60Z FDHC49S FDHC60S
	Fall Prevention Kit 1.20 m stainless steel chain	FDFCS

LED/AREA: NEC/CFC EXPLOSIONPROOF/ATEX/IECEX FLAMEPROOF

Appleton

ATX™ DEMULED LED Series Luminaires

Flameproof

ATEX/IECEX:
 Zone 1 and 2 - 21 and 22
 Ⓢ II2GD
 Ex tb IIIC
 IK09
 IP66/68

LED/AREA: NEC/CEC EXPLOSIONPROOF/ATEX/IECEX FLAMEPROOF

Electrical Wiring Diagram

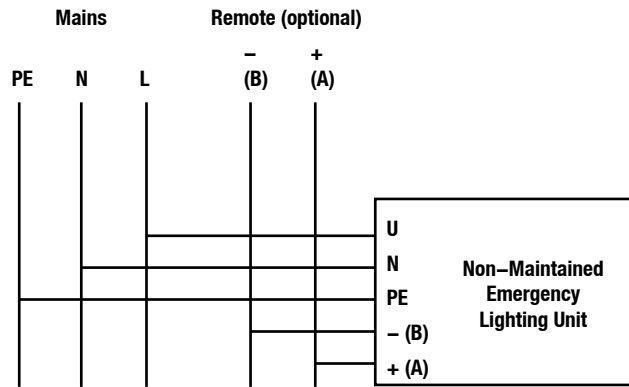

Dimensions in Millimeters (Inches)

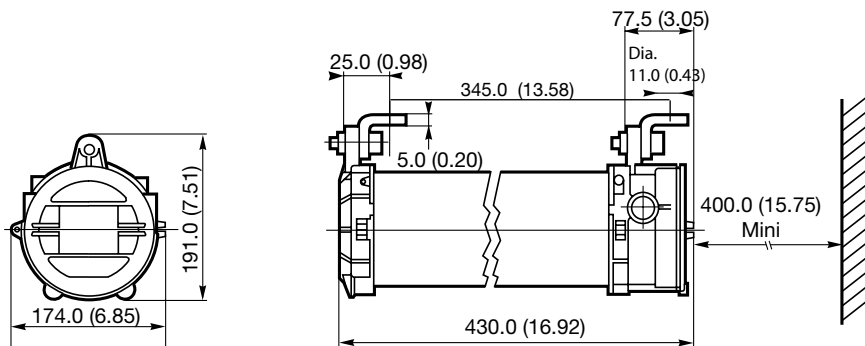

Viamaster™ LED Series Emergency Battery Backup Luminaires

For NEC and CEC Hazardous Locations

NEC/CEC:

Class I, Division 2, Groups A, B, C, D
Class I, Zone 2, Group IIC
Class II, Division 2, Groups F, G
Class III
Type 3R, 4, 4X

NEC/CEC:

Marine Outside Type- For USA Only ☼
IP66/67

Applications

- For use in locations where:
 - Flammable gases, vapors and dusts are present
 - A high degree of corrosion resistance is required
 - Protection against dirt, water and moisture is necessary
- Typical applications include:
 - Oil refineries
 - Petrochemical facilities
 - Pulp and paper mills
 - Food processing plants
 - Waste and sewer treatment
 - Underground tunnels
 - General manufacturing facilities

Features

- Provides up to 1250 lumens illumination for 90 minutes of emergency lighting with clear lens.
- Functional diagnostic test self-initiates every 14 days after initial start up.
- Duration test is automatically performed once per year.
- Green and Red LED lamps indicate charging status and provide fault warning.
- Positive safety switch disconnects power between LEDs and battery management module to allow maintenance in hazardous locations.
- 60,000+ hour LED life, for years of maintenance free operation.
- Universal, high efficiency, driver covers voltage requirements for 120-277 Vac, 50/60 Hz +/- 10%.
- Standard 2KV surge suppression.
- Hinged cover with captive screws, and terminal block wiring for easy installation and maintenance.
- Standard screw-type terminal block can accept UL/CSA 26 to 10 AWG wire.
- Contemporary, low profile design suitable for tight spaces.
- Field replaceable LED driver, battery management module (BMM), battery pack, and lens.
- 5 Cell NiMH battery pack for longer emergency capability.
- Plug in connectors on battery pack for easy maintenance.
- Industry-leading thermal management for safe, reliable operation over a wide temperature range.
- Easy retrofit in same mounting footprint as Appleton's FV Series fluorescent luminaires.
- Full range of lumen outputs, with light distribution equivalent to Appleton's FV Series fluorescent luminaires.
- 2 opposing 3/4" NPT hubs with adjacent terminal blocks for thru wiring. (1) 3/4" NPT close up plug provided.

Options

- Safety cable for fall safe retention; add suffix **-C** to the end of the catalog number.
- Diffused lens is available;
 - Add suffix **-D** to the catalog number.
 - Example: **LLEDA12LU2DH**
- Fusing is available;
 - Add suffix **-F** to the catalog number. ☼
 - Example: **LLEDA12LU2FH**

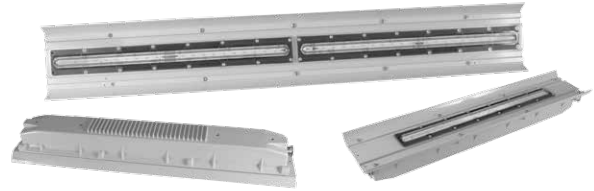

Standard Materials

- Housing: copperfree (4/10 of 1% max.) aluminum
- Lens: thermal shock- and impact-resistant polycarbonate lens
- Gasket: silicone rubber, mechanically secured
- Bolts: stainless steel
- Close up plugs: nickel plated brass
 - Mounting hardware: See ordering information

Standard Finishes

- Housing/Reflector: gray polyester

Related Products

- For specifications on non-emergency operation, refer to Viamaster LED Series Luminaires for NEC and CEC Hazardous Locations.

NEC/CEC Certifications and Compliances

- UL Standard: UL 1598, UL 8750, UL 844, UL 924
- CSA Standards: C22.2 No. 250.0, C22.2 No. 250.13, C22.2 No. 137
- cULus Certified: E165014
- Ambient Temperature:
120-277 Volts: -20 °C up to +55 °C (-4 °F up to +131 °F)

☼ Fusing option not available with Marine Outside Type (Salt Water) rating. Fusing option not permitted for cUL.

Viamaster™ LED Series Emergency Battery Backup Luminaires

For NEC and CEC Hazardous Locations



NEC/CEC:
 Class I, Division 2, Groups A, B, C, D
 Class I, Zone 2, Group IIC
 Class II, Division 2, Groups F, G
 Class III
 Type 3R, 4, 4X

NEC/CEC:
 Marine Outside Type- For USA Only ☼
 IP66/67

Order using catalog numbering guides below or select catalog number from tables on following pages.

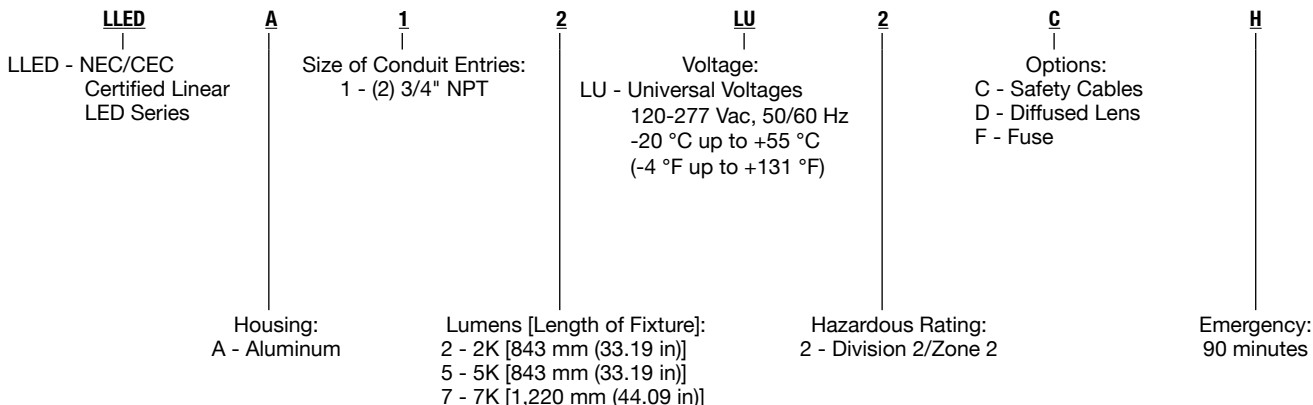
Catalog Numbering Guide – NEC/CEC Certified Linear LED



	Conduit/Cable Entries	Voltage	Weight kg (lb)	Catalog Numbers ①	
				Clear Polycarbonate	Diffused Polycarbonate
2,200 Lumens – 0.843 m (3 ft)					
	3/4" NPT (2)	120-277 Vac, 50/60 Hz	8.75 (19.30)	LLEDA12LU2H	LLEDA12LU2DH
4,600 Lumens – 0.843 m (3 ft)					
	3/4" NPT (2)	120-277 Vac, 50/60 Hz	8.89 (19.60)	LLEDA15LU2H	LLEDA15LU2DH
7,800 Lumens – 1.22 m (4 ft)					
	3/4" NPT (2)	120-277 Vac, 50/60 Hz	9.07 (20.00)	LLEDA17LU2H	LLEDA17LU2DH

① For optional safety cables, add suffix -C to the end of the catalog number. For optional fuse, add suffix -F to the catalog number.

Example: LLEDA12LU2CDFH.

☼ Fusing option not available with Marine Outside Type (Salt Water) rating. Fusing option not permitted for cUL.

Viamaster™ LED Series Emergency Battery Backup Luminaires

For NEC and CEC Hazardous Locations

NEC/CEC:
 Class I, Division 2, Groups A, B, C, D
 Class I, Zone 2, Group IIC
 Class II, Division 2, Groups F, G
 Class III
 Type 3R, 4, 4X

NEC/CEC:
 Marine Outside Type- For USA Only ‡
 IP66/67

Technical Data ①

Luminaire		Ambient Temperature °C (°F)	Supply Wire Temperature °C (°F)	Class I, Division 2 ②	NEC/CEC		Dust	
Lumen Output	Type				Gas Groups	Class I, Zone 2, AEx nA IIC, Ex nA IIC	Class II, Division 2 ③	Groups
2,200	LED	40 (104)	75 (167)	T4	A, B, C, D	T4	T6	F, G
		55 (131)	75 (167)	T3C	A, B, C, D	T3	T5	F, G
		65 (149)	75 (167)	T3C	A, B, C, D	T3	T4A	F, G
4,600	LED	40 (104)	75 (167)	T4A	A, B, C, D	T4	T5	F, G
		55 (131)	75 (167)	T4A	A, B, C, D	T4	T5	F, G
		65 (149)	75 (167)	T4	A, B, C, D	T4	T4A	F, G
7,800	LED	40 (104)	75 (167)	T4A	A, B, C, D	T4	T5	F, G
		55 (131)	75 (167)	T4	A, B, C, D	T4	T4A	F, G
		65 (149)	75 (167)	T4	A, B, C, D	T4	T4A	F, G

“T” Numbers Represent the Maximum Internal Temperature ② or Maximum Surface Temperature ③

“T” #	NEC/CEC															
	T1	350	325	T2	T2A	T2B	T2C	T2D	T3	T3A	T3B	T3C	T4	T4A	T5	T6
Temp. Range °C (°F)	351-450 (664-842)	326-350 (619-662)	301-325 (574-617)	281-300 (538-572)	261-280 (502-536)	231-260 (448-500)	216-230 (421-446)	201-215 (394-419)	181-200 (358-392)	166-180 (331-356)	161-165 (322-329)	136-160 (277-320)	121-135 (250-275)	101-120 (214-248)	86-100 (187-212)	85 (185)

Luminaire Comparison Chart

Catalog Number	Line Current Amps	Input Power	Power Factor	THD	Lumens					
					Clear Polycarbonate	Diffused Polycarbonate	CRI	Color Temp CCT	Length m (ft)	
Standard Operation										
LLEDA12LU2H	.21@120V	24	>0.95	<20%	2200	1800	70	5650K	0.842 (3)	
	.11@277V		>0.87							
LLEDA15LU2H	.43@120V	45	>.95	<20%	4400	3800	70	5650K	0.842 (3)	
	.20@277V									
LLEDA17LU2H	.73@120V	83	>.95	<20%	7800	6400	70	5650K	1.22 (4)	
	.33@277V									
90 Minute Emergency Mode										
LLEDA12LU2H	2.3@6.6V	15	1.00	0	1250	1000	70	5650K	0.842 (3)	
LLEDA15LU2H	2.3@6.6V	15	1.00	0	1250	1000	70	5650K	0.842 (3)	
LLEDA17LU2H	2.3@6.6V	15	1.00	0	1250	1000	70	5650K	1.22 (4)	

① T codes provided in catalog pages are based on worst case data.

② T numbers represent the maximum internal temperature for Class I, Division 2 and Class I, Zone 2 locations designated by the NEC.

③ T numbers represent the maximum surface temperature under a dust blanket for Class II, Division 1 and 2 as designated by the NEC.

‡ Fusing option not available with Marine Outside Type (Salt Water) rating. Fusing option not permitted for cUL.

Viamaster™ LED Series Emergency Battery Backup Luminaires

For NEC and CEC Hazardous Locations

NEC/CEC:
 Class I, Division 2, Groups A, B, C, D
 Class I, Zone 2, Group IIC
 Class II, Division 2, Groups F, G
 Class III
 Type 3R, 4, 4X

NEC/CEC:
 Marine Outside Type- For USA Only ⌘
 IP66/67

Emergency Mode

Illustration of LED operation in Emergency Mode

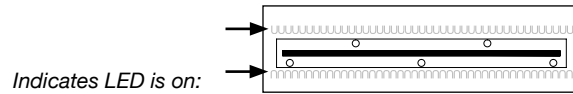

7,000 Lumen Version — 1.22 m (4 ft)

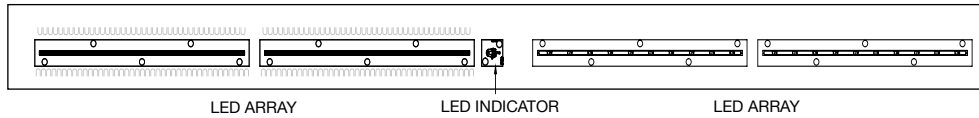

Two arrays on, two arrays off.

5,000 Lumen Version — 0.843 m (3 ft)

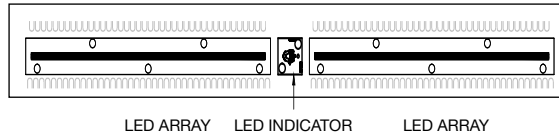

Both arrays on.

2,000 Lumen Version — 0.843 m (3 ft)

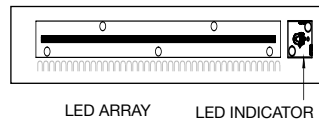

Array on.

Battery Charging Circuit Specifications

Battery Charge Current:	Battery Intermittent Charge:	Battery Type:	Battery Quantity:	Battery Voltage (total):	Battery Capacity:	Battery Charge Time:
300 mA	60 mA	“D” Cell NiMH	5	6 V nominal	6 A-hr	24 hrs

⌘ Fusing option not available with Marine Outside Type (Salt Water) rating. Fusing option not permitted for cUL.

Viamaster™ LED Series Emergency Battery Backup Luminaires

For NEC and CEC Hazardous Locations

NEC/CEC:
 Class I, Division 2, Groups A, B, C, D
 Class I, Zone 2, Group IIC
 Class II, Division 2, Groups F, G
 Class III
 Type 3R, 4, 4X

NEC/CEC:
 Marine Outside Type- For USA Only ⌘
 IP66/67

Automatic Testing System (ATS)	
Functional	Full Duration
Starts within 24 to 45 hours after the initial powerup of the module	Starts within 14 to 35 days after the initial power of the module
Occurs every 14 days after the initial aforementioned functional test	Occurs every 364 days after the initial aforementioned functional test
Lasts for 5 minutes	Lasts for the full duration of the rated emergency period

At the completion of functional and full duration tests, LED indicator will display the status of the emergency luminaire when AC is present

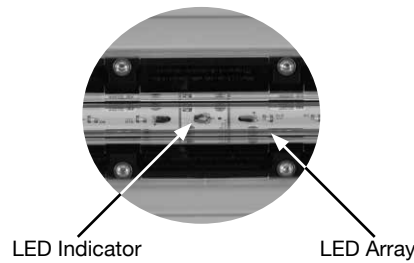

Color	LED Signals	
	Timing	Description
Green	1 sec ON: 1 sec OFF	Charging ok, Battery not yet fully charged, No fault detected, Testing ok
Green	0.25 sec ON: 0.25 sec OFF	Functional / Duration Test on-going
Green	Steady ON	Charging ok, Battery fully charged, No fault detected, Testing ok
Red	1 sec ON: 1 sec OFF	Installation issue. Battery is reverse, not connected or shorted. Functional test failure, full duration test failure
Indicator OFF, LED Array ON	LED OFF	No AC, Emergency mode ON

LED / AREA: NEC/CEC EMERGENCY



⌘ Fusing option not available with Marine Outside Type (Salt Water) rating. Fusing option not permitted for cUL.

Viamaster™ LED Series Emergency Battery Backup Luminaires

For NEC and CEC Hazardous Locations

NEC/CEC:
 Class I, Division 2, Groups A, B, C, D
 Class I, Zone 2, Group IIC
 Class II, Division 2, Groups F, G
 Class III
 Type 3R, 4, 4X

NEC/CEC:
 Marine Outside Type- For USA Only
 ⚡
 IP66/67

Accessories and Replacement Parts

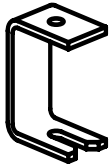
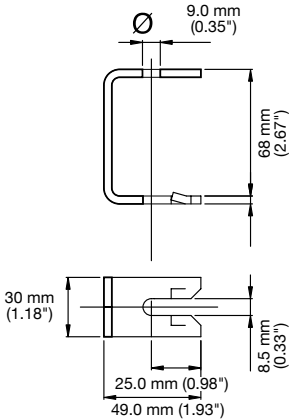
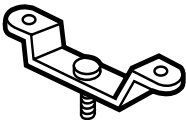
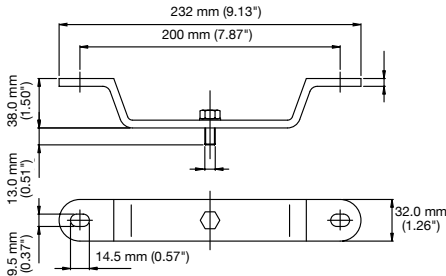
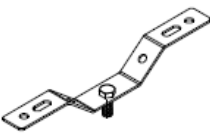
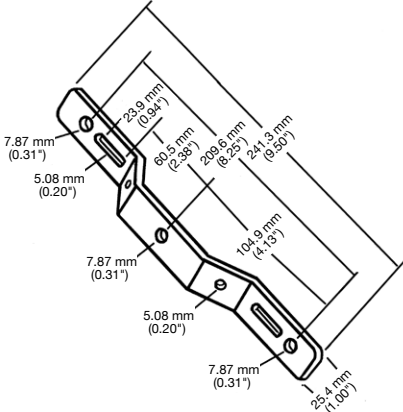
	Description	Catalog Numbers
<p>Mounting Brackets – Set of Two</p>  	<p>Fixing Brackets for Surface Installation</p> <p>316 stainless steel</p>	<p>FEFBS</p>
 	<p>Surface Mounting</p> <p>Aluminium (gray painted) 316 stainless steel</p>	<p>FESBA FESBS</p>
 	<p>Surface Mounting</p> <p>14-gauge stainless steel</p>	<p>FVSM</p>

LED/AREA: NEC/CEC EMERGENCY

Appleton®

⚡ Fusing option not available with Marine Outside Type (Salt Water) rating. Fusing option not permitted for cUL.

Viamaster™ LED Series Emergency Battery Backup Luminaires

For NEC and CEC Hazardous Locations

NEC/CEC:
 Class I, Division 2, Groups A, B, C, D
 Class I, Zone 2, Group IIC
 Class II, Division 2, Groups F, G
 Class III
 Type 3R, 4, 4X

NEC/CEC:
 Marine Outside Type- For USA Only
 ⚡
 IP66/67

Accessories and Replacement Parts

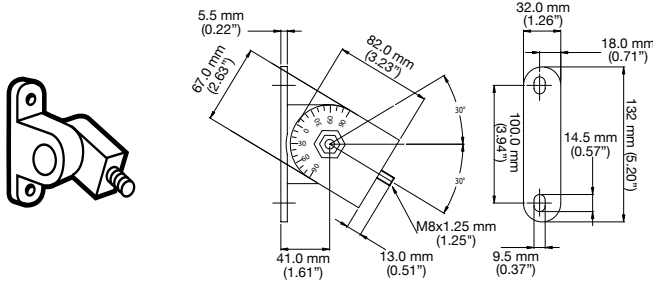
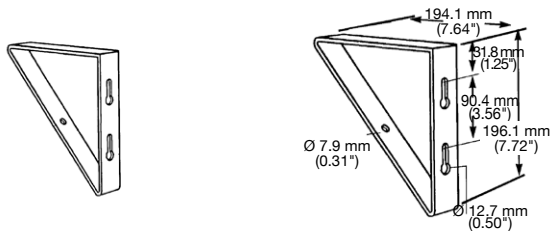
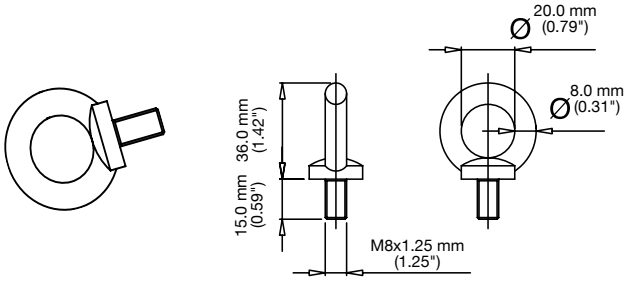
	Description	Catalog Numbers
Mounting Brackets — Set of Two		
	Hinged Brackets for Adjusting Luminaire Aluminum	FEHBA
	Fixed 45° Wall Mount 11-gauge (1/8") stainless steel	FVWFM
	M8 Ring Bolts ① Zinc plated steel — For use with optional safety chain (not provided) Not for use with Marine Listing	FERBM8Z
Safety Cables — Set of Two		
	Safety Cables — Attached to fixtures to guard against them falling when the primary method of attachment fails.	LLEDSC
Replacement Drivers		
	120-277 Vac driver	LLEDBU2
Replacement Lenses		
	Clear Polycarbonate lens with an integral gasket	LLEDGPL
	Diffused lens with an integral gasket	LLEDDPL
Replacement Battery Management Module		
		BMMLED
Replacement Battery Pack		
		BPLLED

① Not for use in Marine applications.

⚡ Fusing option not available with Marine Outside Type (Salt Water) rating. Fusing option not permitted for cUL.

Viamaster™ LED Series Emergency Battery Backup Luminaires

For NEC and CEC Hazardous Locations

NEC/CEC:

Class I, Division 2, Groups A, B, C, D
 Class I, Zone 2, Group IIC
 Class II, Division 2, Groups F, G
 Class III
 Type 3R, 4, 4X

NEC/CEC:

Marine Outside Type- For USA Only ⌘
 IP66/67

Mounting Options Dimensions in Millimeters (Inches)

FEFBS

Ceiling/Surface Mount

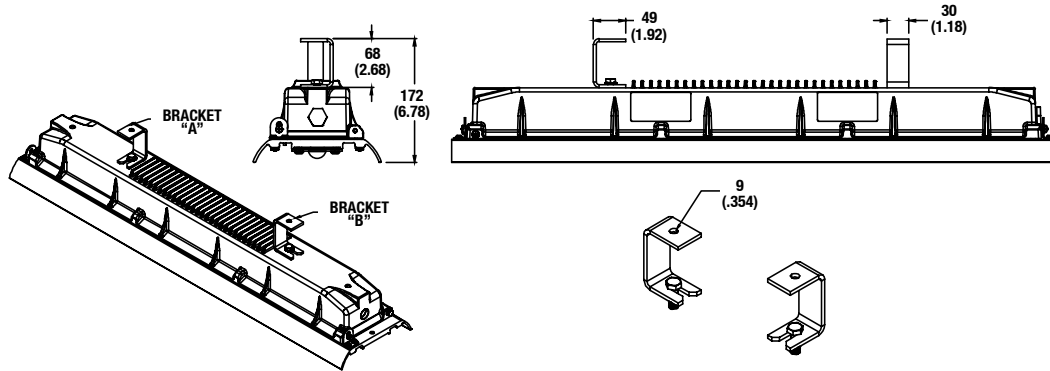

FESBA Aluminum (gray painted)
FESBS 316 stainless steel

Ceiling/Surface Mount

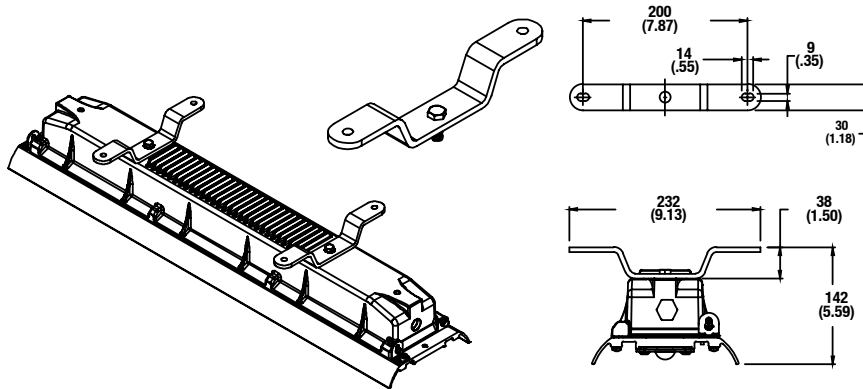

FVSM

Ceiling/Surface Mount

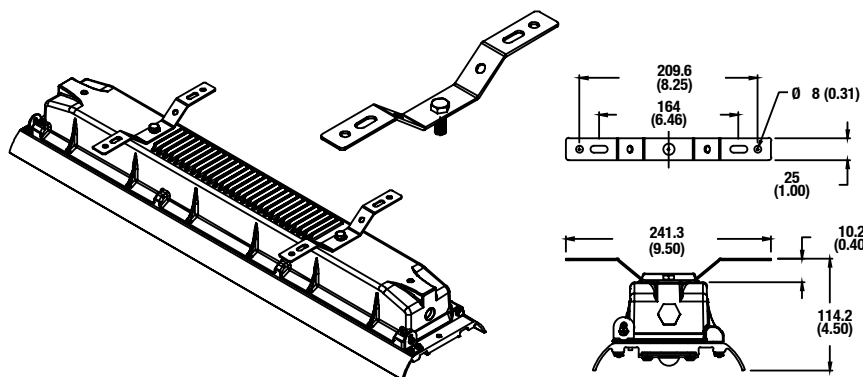

⌘ Fusing option not available with Marine Outside Type (Salt Water) rating. Fusing option not permitted for cUL.

Viamaster™ LED Series Emergency Battery Backup Luminaires

For NEC and CEC Hazardous Locations

NEC/CEC:
 Class I, Division 2, Groups A, B, C, D
 Class I, Zone 2, Group IIC
 Class II, Division 2, Groups F, G
 Class III
 Type 3R, 4, 4X

NEC/CEC:
 Marine Outside Type- For USA Only ⌘
 IP66/67

Mounting Options (continued) Dimensions in Millimeters (Inches)

FEHBA

Wall/Hinged Mount

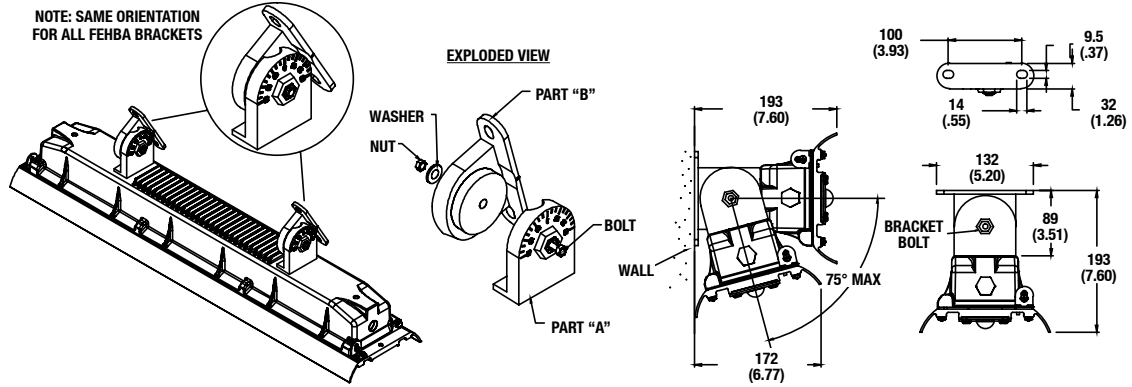

FWFM

Wall/Fixed 45° Mount

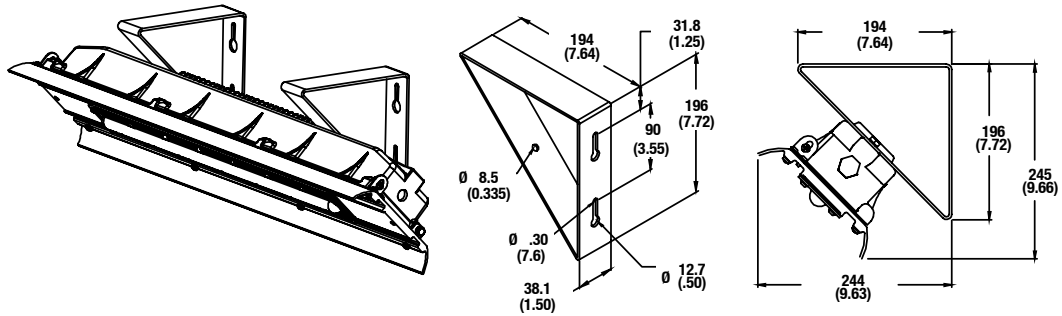

FERBM8Z

Ceiling/Chain Mount

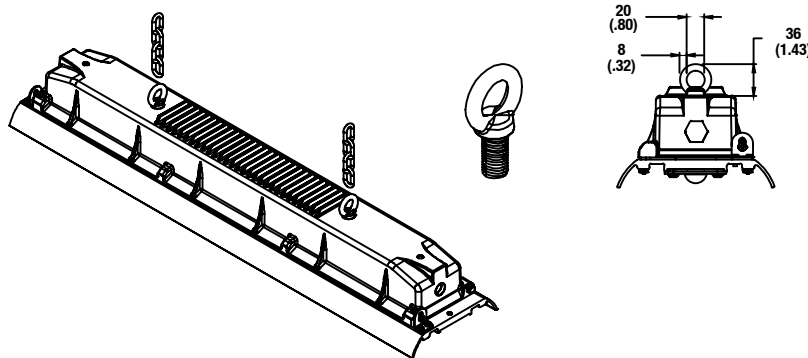

⌘ Fusing option not available with Marine Outside Type (Salt Water) rating. Fusing option not permitted for cUL.

Viamaster™ LED Series Emergency Battery Backup Luminaires

For NEC and CEC Hazardous Locations

NEC/CEC:
 Class I, Division 2, Groups A, B, C, D
 Class I, Zone 2, Group IIC
 Class II, Division 2, Groups F, G
 Class III
 Type 3R, 4, 4X

NEC/CEC:
 Marine Outside Type- For USA Only ☼
 IP66/67

Luminaire Dimensions in Millimeters (Inches)

LLEDA12H and LLEDA15H

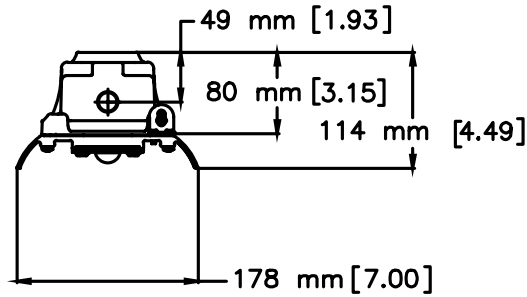

End View — 843 mm (33.19 in) Versions

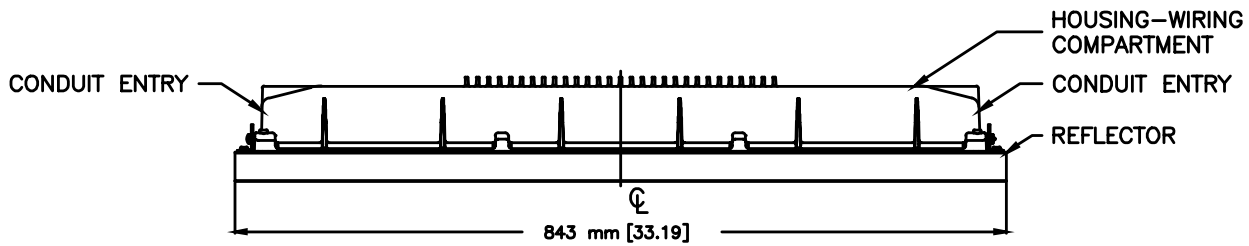

Side View — 843 mm (33.19 in) Versions

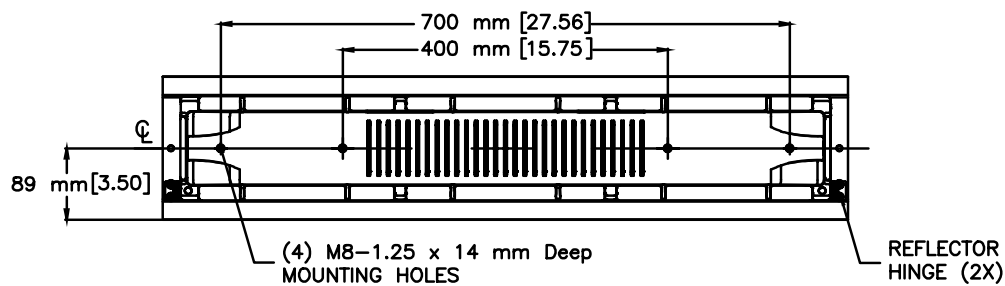

Top (Mounting) View — 843 mm (33.19 in) Versions

☼ Fusing option not available with Marine Outside Type (Salt Water) rating. Fusing option not permitted for cUL.

Viamaster™ LED Series Emergency Battery Backup Luminaires

For NEC and CEC Hazardous Locations

NEC/CEC:
 Class I, Division 2, Groups A, B, C, D
 Class I, Zone 2, Group IIC
 Class II, Division 2, Groups F, G
 Class III
 Type 3R, 4, 4X

NEC/CEC:
 Marine Outside Type- For USA Only ⌘
 IP66/67

Luminaire Dimensions in Millimeters (Inches)

LLEDA17H

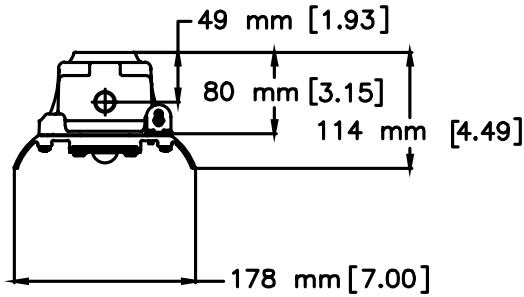

End View — 1,220 mm (44.09 in) Versions

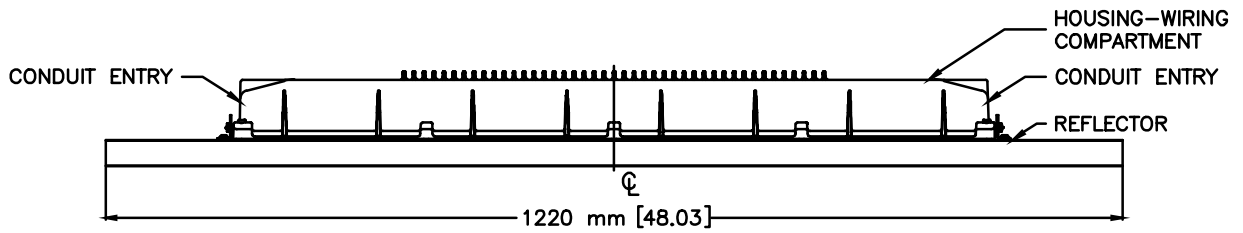

Side View — 1,220 mm (44.09 in) Versions

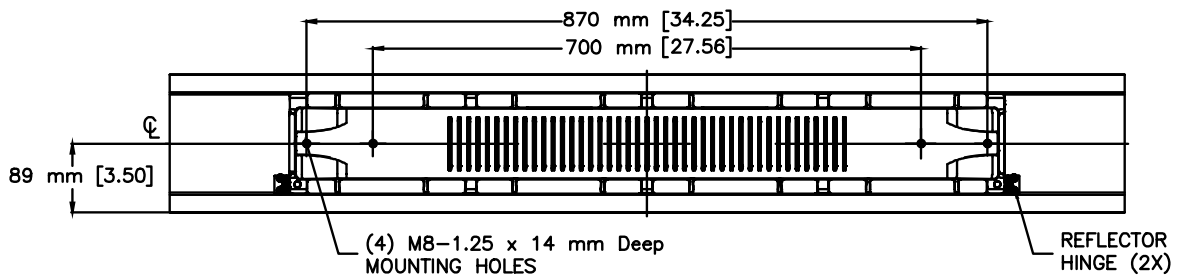

Top (Mounting) View — 1,220 mm (44.09 in) Versions

LED / AREA: NEC / CEC EMERGENCY



⌘ Fusing option not available with Marine Outside Type (Salt Water) rating. Fusing option not permitted for cUL.

Viamaster™ LED Series Emergency Battery Backup Luminaires

For NEC and CEC Hazardous Locations

NEC/CEC:
 Class I, Division 2, Groups A, B, C, D
 Class I, Zone 2, Group IIC
 Class II, Division 2, Groups F, G
 Class III
 Type 3R, 4, 4X

NEC/CEC:
 Marine Outside Type- For USA Only ☼
 IP66/67

Photometric Data — DATA SHOWN IS ABSOLUTE

LLEDA12LU2H with Clear Polycarbonate Lens — Standard Mode

Zonal Lumens and Percentages at 25°C

Zone	Lumens	% Luminaire	Zone	Lumens	% Luminaire
0-30	424.1	20.2	0-10	46.7	2.2
0-40	741.2	35.4	10-20	140.9	6.7
0-60	1521	72.6	20-30	236.4	11.3
60-90	573.3	27.4	30-40	317.2	15.1
0-90	2094	100.0	40-50	378.4	18.1
90-180	0.3	0.0	50-60	401.5	19.2
0-180	2095	100.0	60-70	324.6	15.5
			70-80	209.6	10.0
			80-90	39.1	1.9
			90-100	0.3	0.0

Polar Candela Distribution

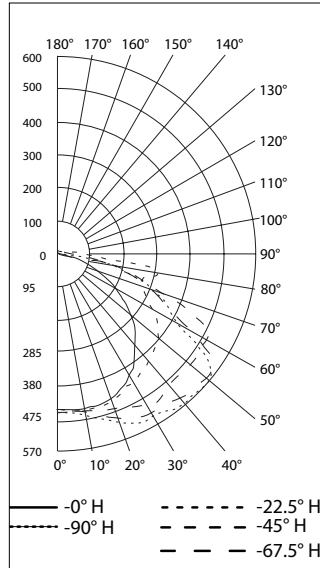

Isoillumination Plot

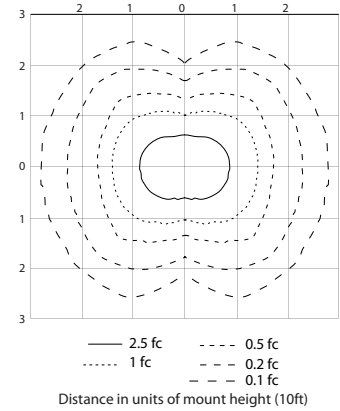

LLEDA12LU2H with Clear Polycarbonate Lens — Emergency Mode

Zonal Lumens and Percentages at 25°C

Zone	Lumens	% Luminaire	Zone	Lumens	% Luminaire
0-30	243.3	20.3	0-10	26.8	2.2
0-40	423.5	35.3	10-20	80.9	6.7
0-60	863.5	71.9	20-30	135.6	11.3
60-90	337.3	28.1	30-40	180.3	15.0
0-90	1201	100.0	40-50	213.9	17.8
90-180	0.1	0.0	50-60	226.0	18.8
0-180	1201	100.0	60-70	188.3	15.7
			70-80	123.1	10.2
			80-90	26.0	2.2
			90-100	0.1	0.0

Polar Candela Distribution

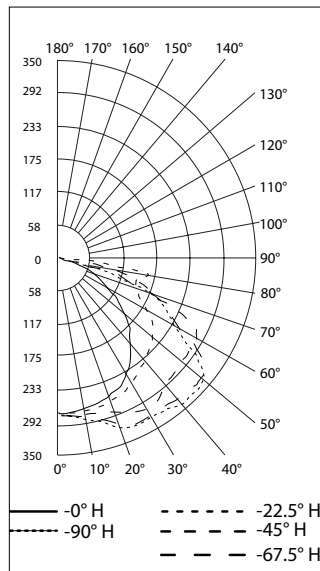

Isoillumination Plot

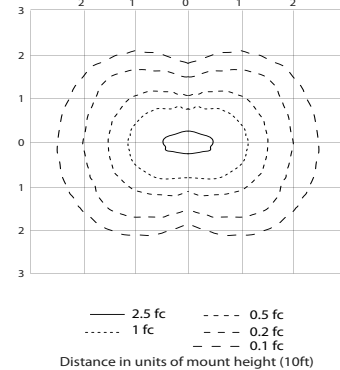

LED/AREA: NEC/CEC EMERGENCY



☼ Fusing option not available with Marine Outside Type (Salt Water) rating. Fusing option not permitted for cUL.

Viamaster™ LED Series Emergency Battery Backup Luminaires

For NEC and CEC Hazardous Locations

NEC/CEC:
 Class I, Division 2, Groups A, B, C, D
 Class I, Zone 2, Group IIC
 Class II, Division 2, Groups F, G
 Class III
 Type 3R, 4, 4X

NEC/CEC:
 Marine Outside Type- For USA Only ⌘
 IP66/67

Photometric Data — DATA SHOWN IS ABSOLUTE

LLEDA12LU2DH with Diffused Polycarbonate Lens — Standard Mode

Zonal Lumens and Percentages at 25°C

Zone	Lumens	% Luminaire	Zone	Lumens	% Luminaire
0-30	429.7	24.6	0-10	52.8	3.0
0-40	702.7	40.3	10-20	150.5	8.6
0-60	1264	72.4	20-30	226.5	13.0
60-90	482.0	27.6	30-40	272.9	15.6
0-90	1746	100.0	40-50	287.4	16.5
90-180	0.0	0.0	50-60	273.6	15.7
0-180	1746	100.0	60-70	236.9	13.6
			70-80	183.1	10.5
			80-90	62.1	3.6

Polar Candela Distribution

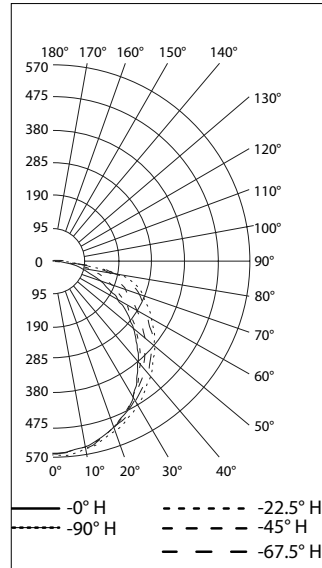

Isoillumination Plot

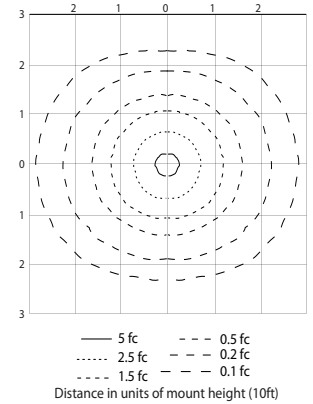

LLEDA12LU2DH with Diffused Polycarbonate Lens — Emergency Mode

Zonal Lumens and Percentages at 25°C

Zone	Lumens	% Luminaire	Zone	Lumens	% Luminaire
0-30	239.3	24.6	0-10	29.4	3.0
0-40	391.3	40.2	10-20	83.8	8.6
0-60	704.3	72.4	20-30	126.1	13.0
60-90	268.1	27.6	30-40	152.0	15.6
0-90	972.3	100.0	40-50	160.4	16.5
90-180	0.0	0.0	50-60	152.6	15.7
0-180	972.4	100.0	60-70	132.2	13.6
			70-80	102.2	10.5
			80-90	33.6	3.5

Polar Candela Distribution

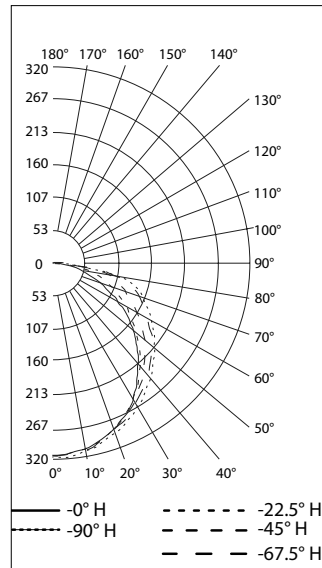

Isoillumination Plot

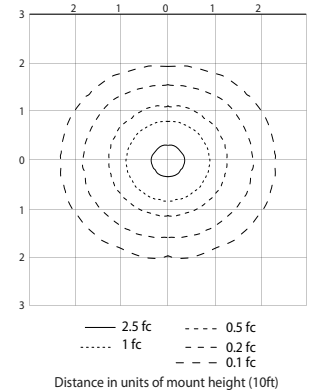

⌘ Fusing option not available with Marine Outside Type (Salt Water) rating. Fusing option not permitted for cUL.

Viamaster™ LED Series Emergency Battery Backup Luminaires

For NEC and CEC Hazardous Locations

NEC/CEC:
 Class I, Division 2, Groups A, B, C, D
 Class I, Zone 2, Group IIC
 Class II, Division 2, Groups F, G
 Class III
 Type 3R, 4, 4X

NEC/CEC:
 Marine Outside Type- For USA Only ⌘
 IP66/67

Photometric Data — DATA SHOWN IS ABSOLUTE

LLEDA15LU2H with Clear Polycarbonate Lens — Standard Mode

Zonal Lumens and Percentages at 25°C

Zone	Lumens	% Luminaire	Zone	Lumens	% Luminaire
0-30	912.8	20.3	0-10	100.4	2.2
0-40	1593	35.5	10-20	303.6	6.8
0-60	3282	73.0	20-30	508.8	11.3
60-90	1206	26.8	30-40	680.0	15.1
0-90	4488	99.9	40-50	822.5	18.3
90-180	4.5	0.1	50-60	866.3	19.3
0-180	4492	100.0	60-70	682.0	15.2
			70-80	438.3	9.8
			80-90	85.9	1.9
			90-100	4.2	0.1
			100-110	0.3	0.0

Polar Candela Distribution

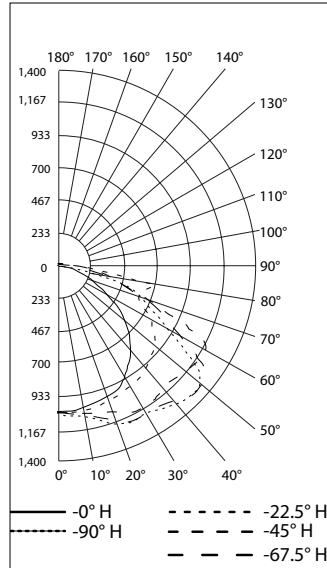

Isoillumination Plot

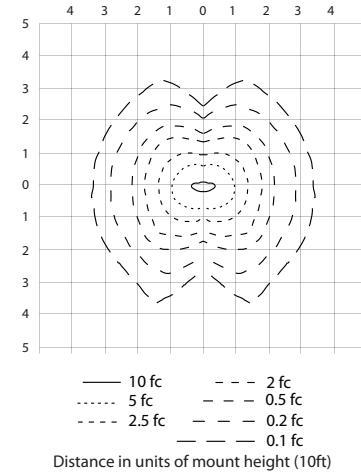

LLEDA15LU2H with Clear Polycarbonate Lens — Emergency Mode

Zonal Lumens and Percentages at 25°C

Zone	Lumens	% Luminaire	Zone	Lumens	% Luminaire
0-30	260.7	19.9	0-10	28.7	2.2
0-40	455.2	34.7	10-20	86.6	6.6
0-60	939.1	71.6	20-30	145.4	11.1
60-90	371.6	28.3	30-40	194.4	14.8
0-90	1311	100.0	40-50	233.1	17.8
90-180	0.4	0.0	50-60	250.8	19.1
0-180	1311	100.0	60-70	209.7	16.0
			70-80	133.0	10.1
			80-90	28.9	2.2
			90-100	0.4	0.0
			100-110		

Polar Candela Distribution

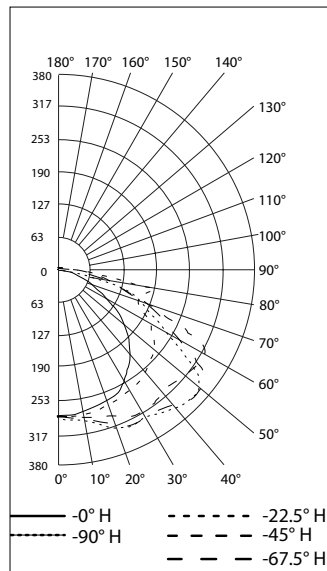

Isoillumination Plot

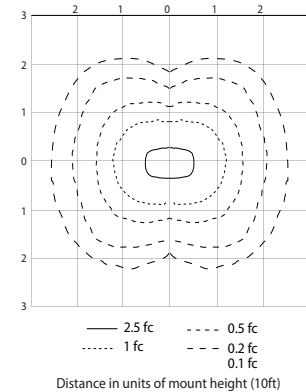

LED/AREA: NEC/CEC EMERGENCY



⌘ Fusing option not available with Marine Outside Type (Salt Water) rating. Fusing option not permitted for cUL.



Viamaster™ LED Series Emergency Battery Backup Luminaires

For NEC and CEC Hazardous Locations

NEC/CEC:
 Class I, Division 2, Groups A, B, C, D
 Class I, Zone 2, Group IIC
 Class II, Division 2, Groups F, G
 Class III
 Type 3R, 4, 4X

NEC/CEC:
 Marine Outside Type- For USA Only ⌘
 IP66/67

Photometric Data — DATA SHOWN IS ABSOLUTE

LLEDA15LU2DH with Diffused Polycarbonate Lens — Standard Mode

Zonal Lumens and Percentages at 25°C

Zone	Lumens	% Luminaire	Zone	Lumens	% Luminaire
0-30	884.1	24.3	0-10	108.2	3.0
0-40	1450	39.8	10-20	308.9	8.5
0-60	2618	71.9	20-30	467.0	12.8
60-90	1017	27.9	30-40	565.5	15.5
0-90	3635	99.8	40-50	598.1	16.4
90-180	7.9	0.2	50-60	570.3	15.7
0-180	3643	100.0	60-70	494.4	13.6
			70-80	382.9	10.5
			80-90	139.8	3.8
			90-100	7.4	0.2
			100-110	0.5	0.0

Polar Candela Distribution

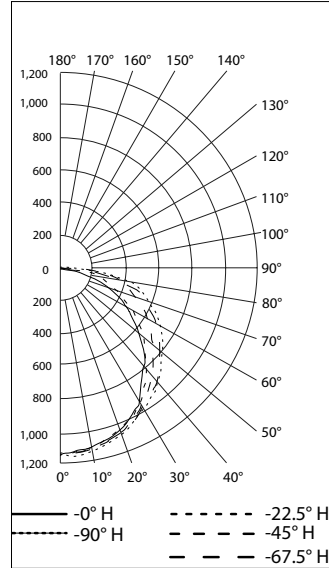

Isoillumination Plot

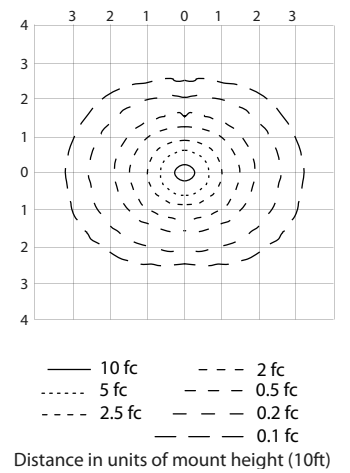

LLEDA15LU2DH with Diffused Polycarbonate Lens — Emergency Mode

Zonal Lumens and Percentages at 25°C

Zone	Lumens	% Luminaire	Zone	Lumens	% Luminaire
0-30	256.6	24.2	0-10	31.4	3.0
0-40	421.3	39.8	10-20	89.6	8.5
0-60	763.1	72.1	20-30	135.6	12.8
60-90	295.6	27.9	30-40	164.7	15.6
0-90	1059	100.0	40-50	174.6	16.5
90-180	0.3	0.0	50-60	167.1	15.8
0-180	1059	100.0	60-70	145.4	13.7
			70-80	112.5	10.6
			80-90	37.7	3.6
			90-100	0.3	0.0

Polar Candela Distribution

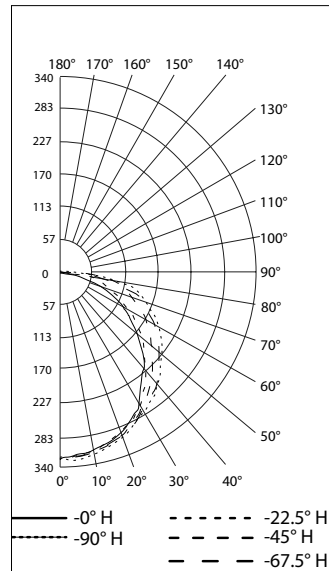

Isoillumination Plot

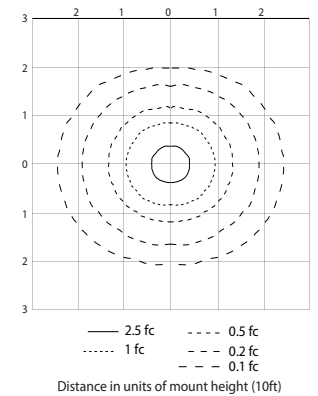

⌘ Fusing option not available with Marine Outside Type (Salt Water) rating. Fusing option not permitted for cUL.

Viamaster™ LED Series Emergency Battery Backup Luminaires

For NEC and CEC Hazardous Locations

NEC/CEC:
 Class I, Division 2, Groups A, B, C, D
 Class I, Zone 2, Group IIC
 Class II, Division 2, Groups F, G
 Class III
 Type 3R, 4, 4X

NEC/CEC:
 Marine Outside Type- For USA Only ⌘
 IP66/67

Photometric Data — DATA SHOWN IS ABSOLUTE

LLEDA17LU2H with Clear Polycarbonate Lens — Standard Mode

Zonal Lumens and Percentages at 25°C

Zone	Lumens	% Luminaire	Zone	Lumens	% Luminaire
0-30	1560	20.0	0-10	170.7	2.2
0-40	2728	34.9	10-20	518.4	6.6
0-60	5631	72.1	20-30	870.5	11.2
60-90	2171	27.8	30-40	1168	15.0
0-90	7802	100.0	40-50	1406	18.0
90-180	2.8	0.0	50-60	1497	19.2
0-180	7805	100.0	60-70	1229	15.7
			70-80	785.7	10.1
			80-90	156.6	2.0
			90-100	2.7	0.0

Polar Candela Distribution

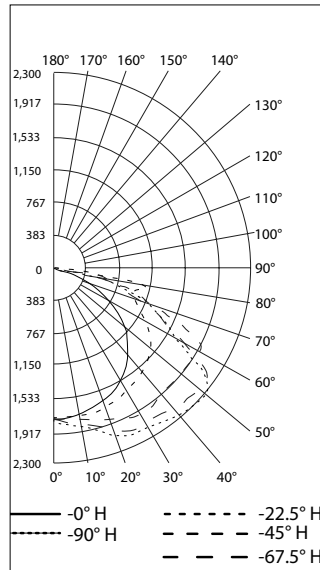

Isoillumination Plot

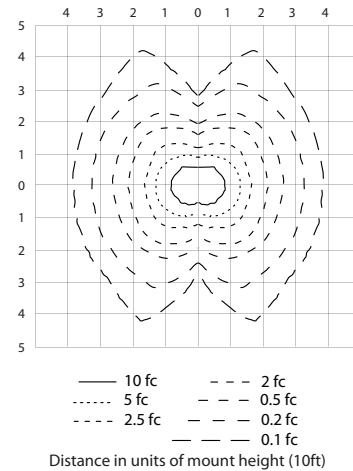

LLEDA17LU2H with Clear Polycarbonate Lens — Emergency Mode

Zonal Lumens and Percentages at 25°C

Zone	Lumens	% Luminaire	Zone	Lumens	% Luminaire
0-30	234.0	19.9	0-10	25.7	2.2
0-40	408.1	34.7	10-20	77.9	6.6
0-60	840.6	71.4	20-30	130.4	11.1
60-90	335.1	28.5	30-40	174.0	14.8
0-90	1176	99.9	40-50	208.6	17.7
90-180	1.0	0.1	50-60	223.9	19.0
0-180	1177	100.0	60-70	186.3	15.8
			70-80	121.0	10.3
			80-90	27.9	2.4
			90-100	1.0	0.1

Polar Candela Distribution

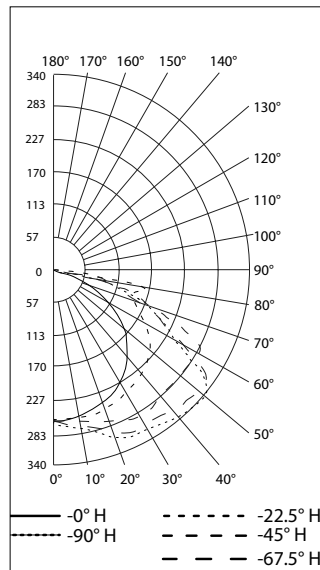

Isoillumination Plot

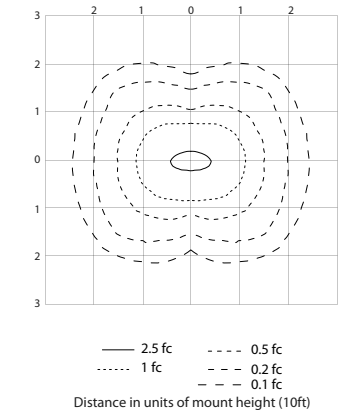

LED/AREA: NEC/CEC EMERGENCY



⌘ Fusing option not available with Marine Outside Type (Salt Water) rating. Fusing option not permitted for cUL.



Viamaster™ LED Series Emergency Battery Backup Luminaires

For NEC and CEC Hazardous Locations

NEC/CEC:
 Class I, Division 2, Groups A, B, C, D
 Class I, Zone 2, Group IIC
 Class II, Division 2, Groups F, G
 Class III
 Type 3R, 4, 4X

NEC/CEC:
 Marine Outside Type- For USA Only ⌘
 IP66/67

Photometric Data — DATA SHOWN IS ABSOLUTE

LLEDA17LU2DH with Diffused Polycarbonate Lens — Standard Mode

Zonal Lumens and Percentages at 25°C

Zone	Lumens	% Luminaire	Zone	Lumens	% Luminaire
0-30	1518	24.1	0-10	185.3	2.9
0-40	2494	39.5	10-20	529.7	8.4
0-60	4528	71.8	20-30	802.9	12.7
60-90	1775	28.1	30-40	976.2	15.5
0-90	6303	99.9	40-50	1038	16.5
90-180	3.4	0.1	50-60	995.8	15.8
0-180	6307	100.0	60-70	868.1	13.8
			70-80	673.7	10.7
			80-90	233.4	3.7
			90-100	3.4	0.1

Polar Candela Distribution

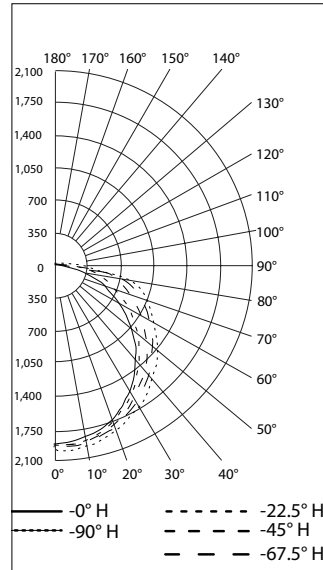

Isoillumination Plot

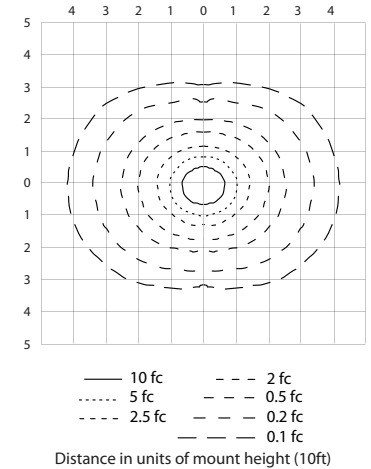

LLEDA17LU2DH with Diffused Polycarbonate Lens — Emergency Mode

Zonal Lumens and Percentages at 25°C

Zone	Lumens	% Luminaire	Zone	Lumens	% Luminaire
0-30	232.0	24.2	0-10	28.4	3.0
0-40	380.8	39.7	10-20	81.0	8.4
0-60	690.0	71.9	20-30	122.6	12.8
60-90	269.3	28.1	30-40	148.8	15.5
0-90	959.4	99.9	40-50	157.9	16.5
90-180	0.7	0.1	50-60	151.3	15.8
0-180	960.1	100.0	60-70	131.9	13.7
			70-80	102.4	10.7
			80-90	35.0	3.6
			90-100	0.7	0.1

Polar Candela Distribution

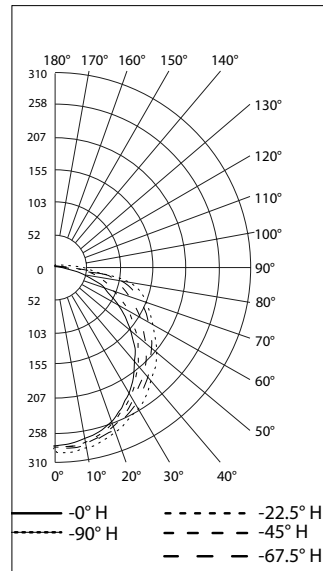

Isoillumination Plot

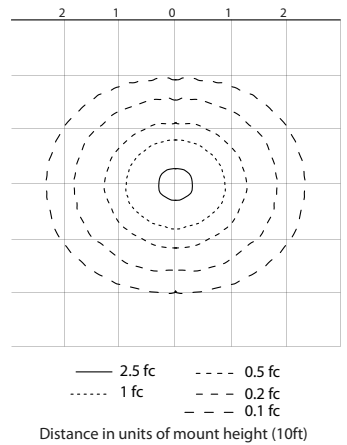

⌘ Fusing option not available with Marine Outside Type (Salt Water) rating. Fusing option not permitted for cUL.

N2LED Series Emergency Luminaires

Non-Metallic Emergency Egress Lighting Systems with Remote or Direct Mounted Lamps.

NEC/CEC:

Class I, Division 2, Groups A, B, C, D

Class I, Zone 2, Group IIC

NEMA Type 4X

IP66

Marine Outside Type (Salt Water)

Applications

- Enclosed and gasketed, non-metallic emergency lighting system suitable for use in areas where flammable gases or vapors may become present due to abnormal, unusual or accidental conditions defined by NEC as Class I, Division 2, Groups A, B, C and D and Class I, Zone 2, Group IIC.
- Typical applications include manufacturing plants, refineries, petrochemical and chemical plants, waste and sewerage treatment facilities, food processing facilities, and other industrial manufacturing or process facilities subject to wet or corrosive conditions.
- Non-hazardous areas where dirt, dust or corrosion would reduce life of ordinary emergency lighting systems.

Features

- Enclosures are raintight and suited for operation in highly corrosive and wet locations.
- The electronics consist of a solid-state charger, transfer circuit and low voltage battery disconnect circuit.
- The integrated, illuminated push to test button is mounted on the system housing using a neoprene O-ring gasket to seal out moisture and liquids.
- Capacity is sufficient for the connection of 6 output watts (maximum).
- System supports 4 light heads in any main/remote combination utilizing up to 6 Watts of output power.
 - This allows for a main unit without any light heads to drive up to 4 remote units or any other combination of 4 lights.
- Provides 100% lumen output for 90 minutes of operation with four light heads or 180 minutes of operation with two light heads.
- The solid-state charger maintains battery at full charge
- Upon power failure or utility voltage (AC) below 50 V, the DC emergency lighting load is connected to the battery.
- During emergency operation, the battery is automatically protected from deep discharge damage by a low-voltage battery disconnect (LVD) circuit.
- Upon restoration of normal power, the charger brings the battery to full capacity within acceptable UL time standards.
- Integrated, illuminated push to test button:
 - Indicates presence of AC line voltage and system error codes
 - Activates push to test function
- A universal input circuit allows operation from 120 to 277 Vac, 50/60 Hz lines.
- Maintenance-free NiCd battery is suited for harsh temperature environments of 0 °C to +55 °C (+32 to +131 °F).
- Remote lamp head assemblies (one or two) are available for mounting of lamp heads away from main power supply system.
- An automatic test feature provides periodic self-test of the system functions every 30 days.
- Status indicator light allows easy monitoring of system status and failure modes.

Standard Materials

- Lighting system:
 - Body: fiberglass reinforced polyester
 - Cover gasket: continuous silicone
 - Push to test switch: fiberglass reinforced polyester (FRP), neoprene gaskets
 - Hub: nickel plated brass
 - Cover screws: stainless steel
 - Lampheads: aluminum

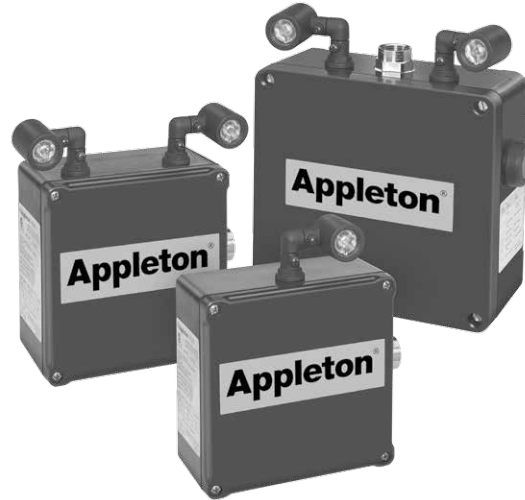

- Remote unit:
 - Body: fiberglass reinforced polyester (FRP); specially formulated with low resistivity, will not hold static charge
 - Cover screws: stainless steel
 - Gasket: neoprene gasket

NEC/CEC Certifications and Compliances

- UL Standards:
 - 1598A (Supplemental Requirements for Luminaires for Installation on Marine Vessels)
 - 924 (Emergency Lighting and Power Equipment)
 - 844 (Electric Luminaires Hazardous Locations)
- CSA Standards:
 - C22.2 No. 141-M1985 unit equipment for emergency lighting
 - C22.2 No. 137-M1981 non-incendive electrical equipment for use in Class I, Division 2 hazardous locations
- Life Safety Code NFPA101® – Section 5-9 (Emergency Lighting)
- Marine wet locations suitability, Type 4X
- cCSAus Certified: 2715744

N2LED Series Emergency Luminaires

Enclosed and Gasketed

Non-Metallic Emergency Egress Lighting Systems with Remote or Direct Mounted Lamps.

NEC/CEC:

Class I, Division 2, Groups A, B, C, D

Class I, Zone 2, Group IIC

NEMA Type 4X

IP66

Marine Outside Type (Salt Water)

Order using catalog numbering guide below or select catalog number from tables on following pages.

Catalog Numbering Guide For N2LED Master Units

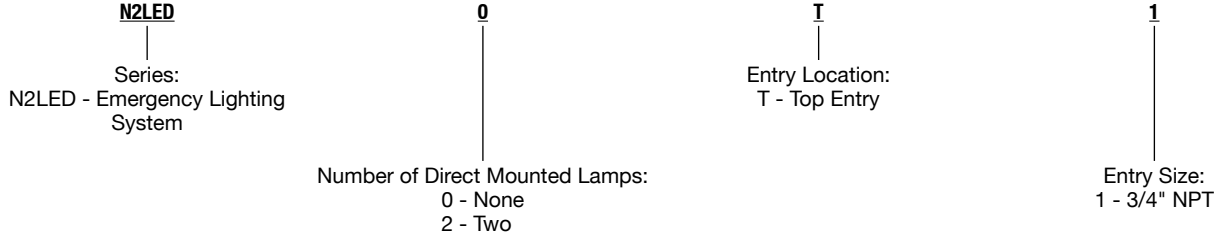

Catalog Numbering Guide For N2LED Remote Units

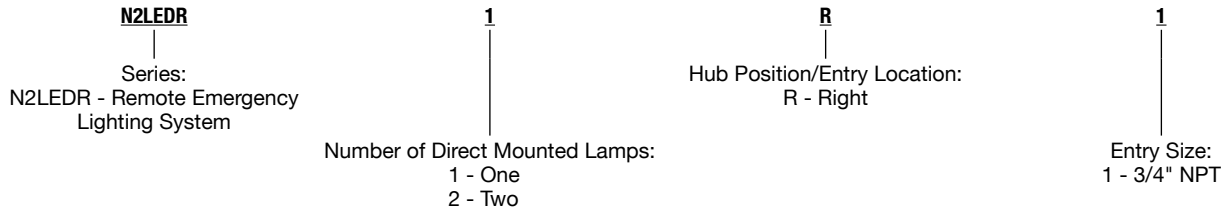

Thermal Performance – Operating Temperatures

Wire Supply	Ambient Temperature	“T” Number
60 °C (140 °F)	0 °C to +55 °C (+32 °F to +131 °F).	T6

“T” Numbers Represent the Maximum Lamp Temperature for Class I, Division 2 Locations

“T” Number	T1	350	325	T2	T2A	T2B	T2C	T2D	T3	T3A	T3B	T3C	T4	T4A	T5	T6
Temp Range (°C)	351-450	326-350	301-325	281-300	261-280	231-260	216-230	201-215	181-200	166-180	161-165	136-160	121-135	101-120	86-100	85
Temp. Range (°F)	664-842	619-662	574-617	538-572	502-536	448-500	421-446	394-419	358-392	331-356	322-329	277-320	250-275	214-248	187-212	185

LED / AREA: NEC/CEC EMERGENCY



N2LED Series Emergency Luminaires

Enclosed and Gasketed

Non-Metallic Emergency Egress Lighting Systems with Remote or Direct Mounted Lamps.

NEC/CEC:

Class I, Division 2, Groups A, B, C, D

Class I, Zone 2, Group IIC

NEMA Type 4X

IP66

Marine Outside Type (Salt Water)

Lamp Comparison Chart

Number of LED Lamps	Input Power	Lumens	CRI	Lamp Life (Hours)	Color Temp CCT
1	1.256 Watts	131.0	70	50,000+	5650K
2	2.513 Watts	257.8	70	50,000+	5650K

Photometric and Electrical Measurements at Ambient Temperature (25°C +/- 1°C) – Distribution Method

Number of LED Lamps	Base Orientation	Input Voltage Vdc	Input Current (mA)	Input Power (Watts)	Input Power Factor	Absolute Luminous Flux (Lumens)	Lumen Efficacy (Lumens Per Watt)
1	Up	2.9	437.0	1.256	1.000	131.0	104.3
2	Up	2.9	874.0	2.513	1.000	257.8	102.6

Wire Sizing For Remote Installations

For copper wire, maximum distance (feet) between power supply and remote unit to limit voltage drop to 5%.

Wire Gage	Maximum Wire Length m (ft)
18 AWG	23.8 (78)
16 AWG	38.1 (125)
14 AWG	60.4 (198)
12 AWG	96.0 (315)
10 AWG	152.4 (500)

System Status

Status Indication	Status Description	Status Definition
	No light	AC power removed from circuit
*	Continuous steady light	Battery fully charged
* _ *	Light blinks once	Battery charging
** **	Light blinks twice	Battery failure
*** ***	Light blinks three times	LED lamp head failure
**** ****	Light blinks four times	Emergency circuit charger board failure

N2LED Series Emergency Luminaires

Enclosed and Gasketed

Non-Metallic Emergency Egress Lighting Systems with Remote or Direct Mounted Lamps.

NEC/CEC:

Class I, Division 2, Groups A, B, C, D

Class I, Zone 2, Group IIC

NEMA Type 4X

IP66

Marine Outside Type (Salt Water)

Main System

	Number of LED Lamps	Total Watts of LED Lamps	Hub Size	Input Voltage	Frequency	Weight kg (lb)	Catalog Number
--	---------------------	--------------------------	----------	---------------	-----------	----------------	----------------

Emergency Lighting System With Two Direct Mount Lamps



2

3

3/4"

120-277

50/60 Hz

3.27 (7.2)

N2LED2T1

Emergency Lighting System Without Direct Mount Lamps



—

—

3/4"

120-277

50/60 Hz

3.04 (6.7)

N2LED0T1

Remote System

	Number of LED Lamps	Total Watts of LED Lamps	Hub Size	Hub Position	Weight kg (lb)	Catalog Number
--	---------------------	--------------------------	----------	--------------	----------------	----------------

Remote Mount With One Lamp



1

1.5

3/4"

Dead End Hub on Right

1.45 (3.2)

N2LEDR1R1

Remote Mount With Two Lamps



2

3

3/4"

Dead End Hub on Right

1.59 (3.5)

N2LEDR2R1

Replacement Parts

Description	Catalog Number
Emergency Lamp Kit	N2LEDLH
Emergency Battery Pack Kit	N2LEDBP
Emergency Circuit Charger Board Kit	N2LEDCB
Nickel Plated Brass M25 Male, 3/4" NPT Female Hub	737DM3T25

LED/AREA: NEC/CEC EMERGENCY

Appleton

N2LED Series Emergency Luminaires

Enclosed and Gasketed

Non-Metallic Emergency Egress Lighting Systems with Remote or Direct Mounted Lamps.

NEC/CEC:
 Class I, Division 2, Groups A, B, C, D
 Class I, Zone 2, Group IIC
 NEMA Type 4X
 IP66
 Marine Outside Type (Salt Water)

Dimensions in Millimeters (Inches)

Emergency Lighting System With Two Direct Mount Lamps

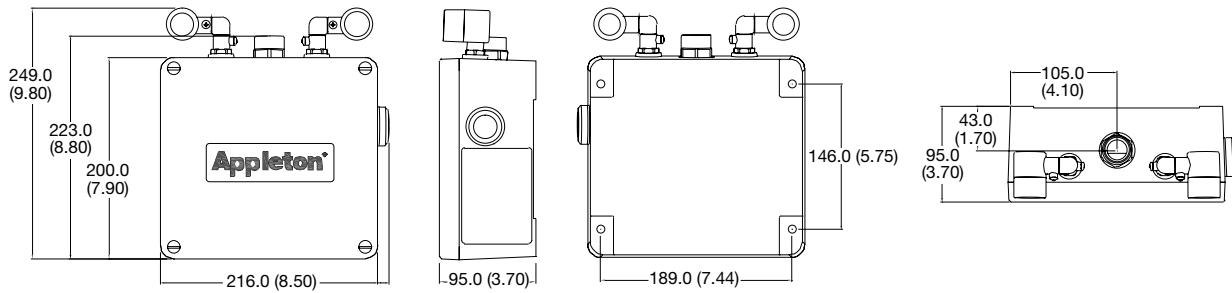

Adjustment Angle — Top View

Side View

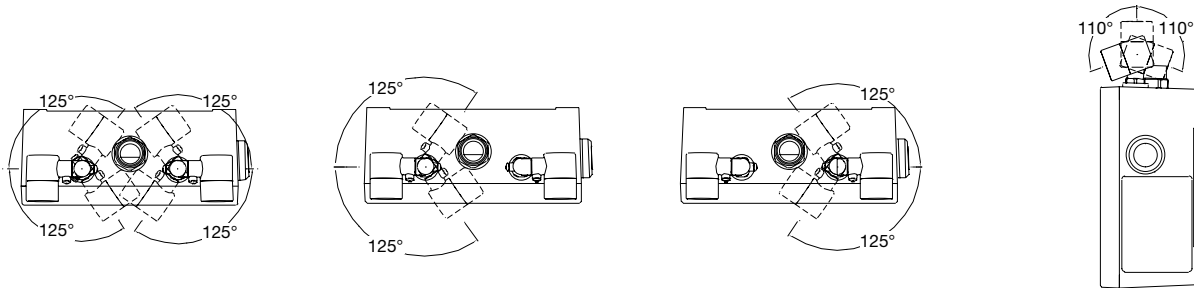

Emergency Lighting System Without Direct Mount Lamps

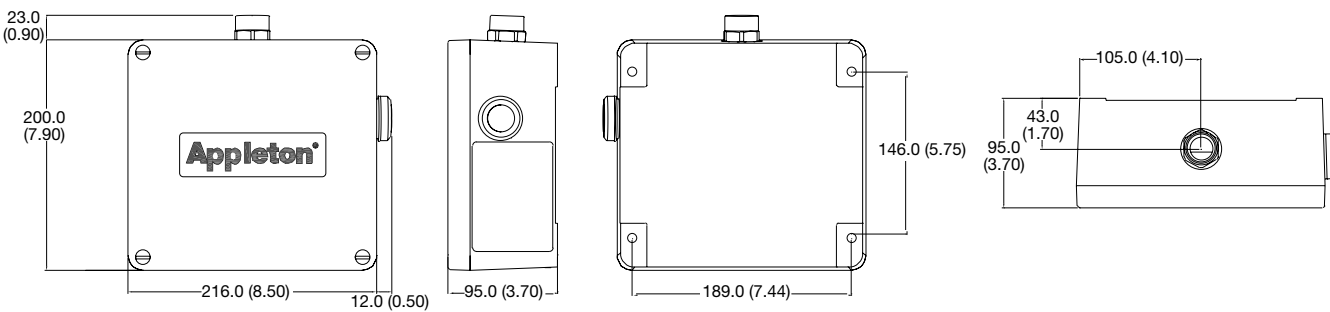

LED/AREA: NEC/CEC EMERGENCY

Appleton

N2LED Series Emergency Luminaires

Enclosed and Gasketed

Non-Metallic Emergency Egress Lighting Systems with Remote or Direct Mounted Lamps.

NEC/CEC:

Class I, Division 2, Groups A, B, C, D

Class I, Zone 2, Group IIC

NEMA Type 4X

IP66

Marine Outside Type (Salt Water)

Dimensions in Millimeters (Inches)

Remote Mount With One Lamp

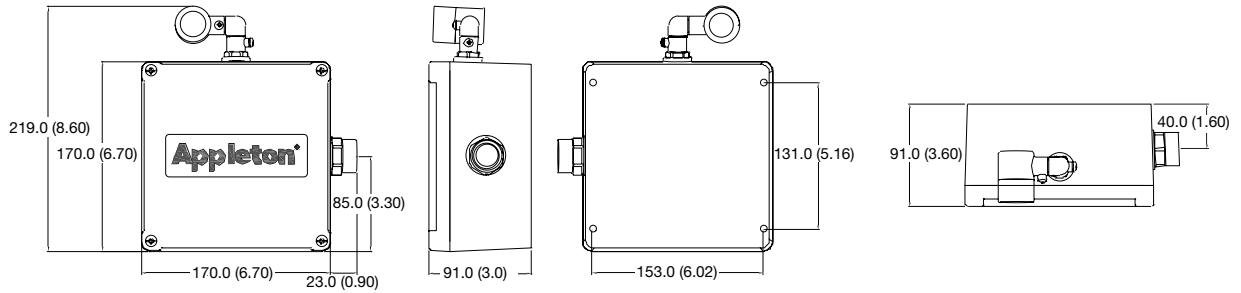

Adjustment Angle — Top View

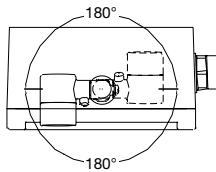

Side View

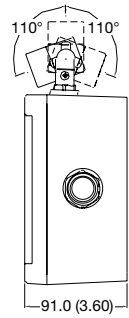

LED / AREA: NEC / CEC: EMERGENCY

Appleton

N2LED Series Emergency Luminaires

Enclosed and Gasketed

Non-Metallic Emergency Egress Lighting Systems with Remote or Direct Mounted Lamps.

NEC/CEC:

Class I, Division 2, Groups A, B, C, D

Class I, Zone 2, Group IIC

NEMA Type 4X

IP66

Marine Outside Type (Salt Water)

Photometric Data – DATA SHOWN IS ABSOLUTE

MODEL: N2LED, Wall Mount LED Emergency Luminaire, Single Lamp

Candela Distribution					
	0.0	22.5	45.0	67.5	90.0
0	663	663	663	663	663
5	603	569	547	540	527
10	377	350	370	394	391
15	188	172	202	249	255
20	86	80	97	123	119
25	36	34	42	41	46
30	15	14	16	30	36
35	6	6	9	20	25
40	3	3	6	11	14
45	2	2	4	5	3
50	2	2	3	2	2
55	2	2	2	2	2
60	1	1	1	1	1
65	0	0	1	1	1
70	0	0	0	0	0
75	0	0	0	0	0
80	0	0	0	0	0
85	0	0	0	0	0
90	0	0	0	0	0

Zonal Lumen Summary		
Zone	Lumens	% Fixture
0-30	117.9	90.0
0-40	125.5	95.8
0-60	130.2	99.4
60-90	0.8	0.6
0-90	131.0	100.0
90-180	0.0	0.0
0-180	131.0	100.0

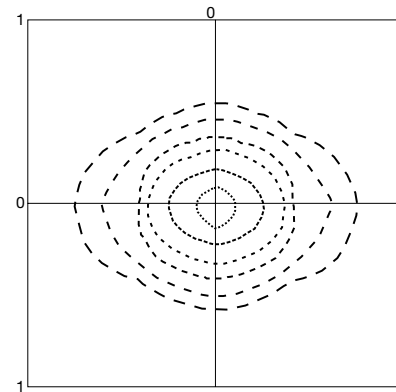

Distance in units of mounting height (10 ft)
 20 fc ——— 1 fc - · - · -
 10 fc - - - - 0.5 fc - - - -
 5 fc · · · · · 0.2 fc · · · · ·
 2.5 fc · · · · · 0.1 fc - · - · -

MODEL: N2LED, Wall Mount LED Emergency Luminaire, Two Lamp

Candela Distribution					
	0.0	22.5	45.0	67.5	90.0
0	1241	1241	1241	1241	1241
5	1196	1110	1049	1011	989
10	844	764	761	763	737
15	469	426	461	506	486
20	225	206	239	264	234
25	93	87	107	91	97
30	40	37	40	66	74
35	17	16	23	44	51
40	7	7	14	26	28
45	4	5	8	11	6
50	4	4	6	5	4
55	4	4	5	4	3
60	2	2	3	3	2
65	1	1	2	2	1
70	0	1	1	1	1
75	0	0	0	1	0
80	0	0	0	0	0
85	0	0	0	0	0
90	0	0	0	0	0

Zonal Lumen Summary		
Zone	Lumens	% Fixture
0-30	230.9	89.6
0-40	246.7	95.7
0-60	255.9	99.3
60-90	1.8	0.7
0-90	257.8	100.0
90-180	0.0	0.0
0-180	257.8	100.0

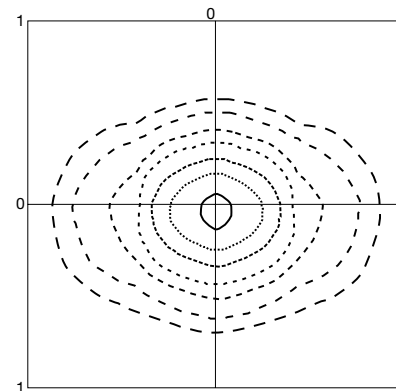

Distance in units of mounting height (10 ft)
 20 fc ——— 1 fc - · - · -
 10 fc - - - - 0.5 fc - - - -
 5 fc · · · · · 0.2 fc · · · · ·
 2.5 fc · · · · · 0.1 fc - · - · -

LED/AREA: NEC/CEC EMERGENCY



Industrial Mercmaster™ LED Low Profile Luminaires

For Ordinary Locations

NEC/CEC:

cULus Listed
Type 3R, 4, 4X
IP66

Suitable for Use in Wet Locations
Marine Outside Type (Salt Water)

Applications

- Ordinary location fixtures suitable for use in:
 - Heavy industrial locations where severe weather conditions, excessive moisture, dirt, dust, corrosive atmospheres, or high ambient temperatures are encountered.
 - Marine and wet locations
 - Areas of low clearance, low ceiling heights or where fixture weights must be minimized
- Typical applications include:
 - Manufacturing plants
 - Storage area/warehouse
 - Platforms
 - Loading docks
 - Food processing
 - Parking garages

Features

- Compact light weight low profile design is suited for low mounting heights.
- Six standard mounting hood designs allow for mounting in any location. Uses same mounting hoods as Mercmaster III.
- Customize to the application requirements with four different globe options: clear and diffused polycarbonate, clear glass, or prismatic glass refractor.
- Three light output levels for retrofit of HID fixtures up to 150 W.
- Hinge has high lip for added safety during installation and servicing. Hinge and bolt construction assures 360° compression at all points on fixture housing gasket for positive sealing. Swing away design of captive bolt and nut simplifies servicing.
- Operating ambient: -40 °C to 55 °C (-40 °F to +131 °F).
- Standard NPT threads.

Options

- Glass globe guard is stainless steel wire. Glass refractor guard is die cast aluminum with gray epoxy powder coating.
- All Mercmaster mounting hoods have provision for fusing; add suffix -F at the end of the catalog number.
- Photocontrols are available with all except ceiling and pendant cone mounting hoods, and are configured to your operating voltage.

Standard Materials

- Mounting hoods and bodies: cast copperfree (4/10 of 1% max.) aluminum
- All hardware and catch assemblies: stainless steel
- Globe: polycarbonate or glass
- Refractor: heat-resistant prismatic glass
- Glass globe guard: stainless steel wire
- Refractor guard: die cast aluminum
- 30° angle reflectors: fiberglass reinforced white polyester



Standard Finishes

- Mounting hoods, bodies and glass refractor guard: baked gray epoxy powder coat finish, electrostatically applied for complete uniform protection

NEC/CEC Certifications and Compliances

- UL Standard: UL 50/50E, UL 1598, UL 1598A, UL 8750
- CSA Standard: C22.2 No. 0; C22.2 No. 0.4; C22.2 No. 0.5; C22.2 No. 94.1/94.2; C22.2 No. 60529; C22.2 No. 250.0
- ANSI/IEC Standard: 60529
- cULus Listed: E279986
- DLC Qualified Products Listed

Related Products

- Photocells are available, see *PC Series*.
 - Mounting hoods with photocontrols are not rated IP66, Type 4X or Marine Outside Type (Salt Water)

DesignLights™ Consortium

- All Industrial Mercmaster™ LED Low Profile luminaires are listed and meet Design Lights Consortium performance standards.

Industrial Mercmaster™ LED Low Profile Luminaires For Ordinary Locations

NEC/CEC:
cULus Listed
Type 3R, 4, 4X
IP66
Suitable for Use in Wet Locations
Marine Outside Type (Salt Water)

Illustrated Features

Heatsink

Reliable heat transfer via the cast, epoxy powder coat aluminum body. Provides maximum heat dissipation from the LED assembly to the outside environment.



Fuses (optional)

Two screws secure fuse kit to mounting boss in any Mercmaster mounting hood. Fuse included. Use of fuse voids Marine Outside type (salt water) rating.

Photocell (optional)

Available for all fixtures except cone and ceiling mount. Provides continuous ON-OFF dusk-to-dawn control. *Note: Fixtures with photocontrols are not rated IP66, Type 4X, Marine Outside Type (Salt Water), or Class II.*

Prismatic Refractors

Heat-resistant refractor threads directly into fixture housing and seal against a high-temperature silicone rubber gasket.



Vented Reflectors

Reflectors are thick, tough fiberglass reinforced white polyester. Quickly attach with furnished stainless steel screws.



Epoxy Finish

Fixture housing, hoods and guards are copperfree aluminum with epoxy powder coat finish.

Electrical Protection

Ground wire provided to bond mounting hood to fixture housing.

"Safety" High Hinge

Extra-high hinge provides additional protection against accidental fixture housing disengagement during installation or maintenance.

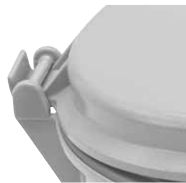

LED Chamber

Protected by polycarbonate or glass lens, allows for easy maintenance access.



Cooler Operating Cone Hood

Larger sloped surface sheds dusts and dirt providing better heat dissipation.

Mounting Hood and Globe Gaskets

Silicone rubber gaskets seal out moisture, dirt and dust. Stays flexible, withstands high temperatures. Closure design assures uniform gasket compression.

Stainless Steel Latch Assembly

Captive, stainless steel latch assembly bolt and nut closes securely, resists attack of corrosive atmospheres. Swing-away design simplifies servicing.



LED/AREA: NEC/CEC ORDINARY LOCATION

Appleton

Industrial Mercmaster™ LED Low Profile Luminaires

For Ordinary Locations

NEC/CEC:
 cULus Listed
 Type 3R, 4, 4X
 IP66
 Suitable for Use in Wet Locations
 Marine Outside Type (Salt Water)

Industrial Mercmaster LED Low Profile Family Tree

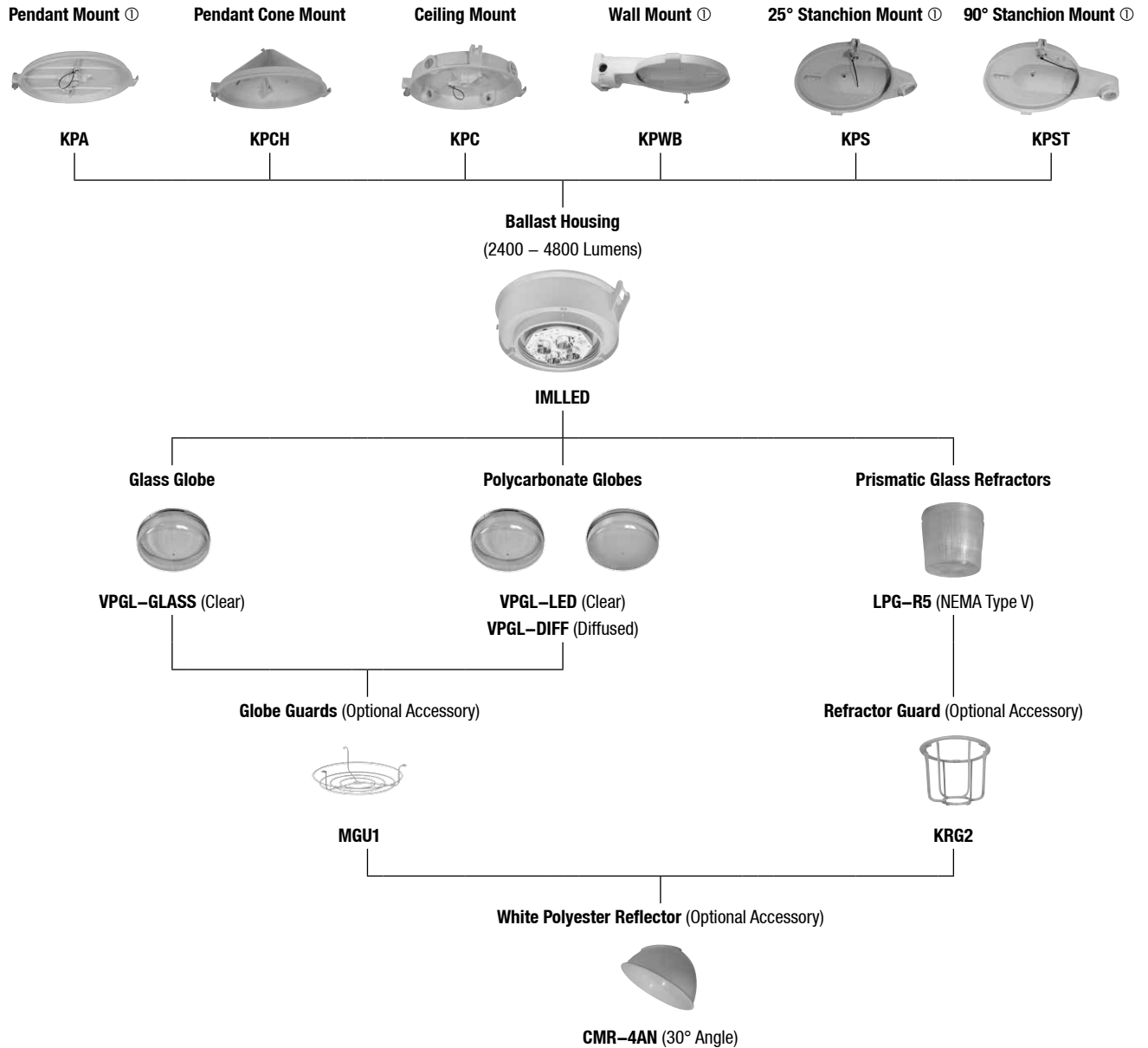

① Mounting hood with a 120 V or 208-277 V factory installed photocell is available.

Industrial Mercmaster™ LED Low Profile Luminaires

For Ordinary Locations

NEC/CEC:
 cULus Listed
 Type 3R, 4, 4X
 IP66
 Suitable for Use in Wet Locations
 Marine Outside Type (Salt Water)

Order using catalog numbering guides below or select catalog number from tables on following pages.

Catalog Numbering Guide

For Ordinary Locations:

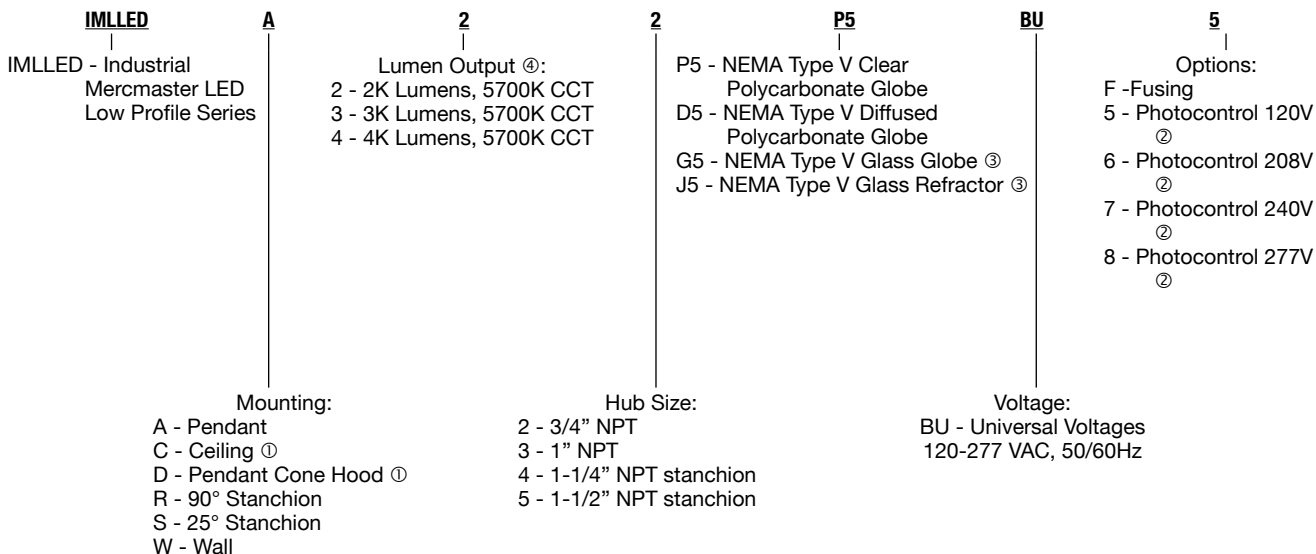

Lamp Comparison Chart

Model	Line Current Amps	Input Power	Power Factor	THD	Lumens ⑤				CRI	Lamp Life (Hours)	Color Temp CCT	Equivalent HID Luminaire
					Polycarbonate Clear Globe	Polycarbonate Diffused Globe	Glass Clear Globe	Type V Prismatic Glass Refractor				
NEMA Type V												
IMLLED2	.21 @120V	26	> .97	< 20%	2400	2300	2500	2200	>70	60,000+	5700K	70 W
	.10 @277V	26										
IMLLED3	.29 @120V	35	> .97	< 20%	3400	3300	3600	3100	>70	60,000+	5700K	100 W
	.13 @277V	34										
IMLLED4	.41 @120V	48	> .88	< 20%	4800	4600	5000	4300	>70	60,000+	5700K	150 W
	.20 @277V	48										



Surge Protection Common/Differential Mode:
 100kHz Ring Wave (w/t 30Ω): 6 KV
 1.2/50 μs Combination Wave (w/t 2Ω): IMLLED2, IMLLED3 4 KV; IMLLED4 3 KV

① Ceiling and pendant cone hood mounted luminaires are not designed to use the PC photocontrol. Ceiling mounts must use an FS/FD box with a photocontrol. Contact your local sales representative for more information.
 ② Luminaires with photocontrol are not rated IP66 or Marine Outside Type (Salt Water).
 ③ Guards for the glass refractors and globes are ordered separately. See the list of accessories for more information.
 ④ For specific lumen output information, see Lamp Comparison Chart.
 ⑤ All lumen values are typical (+/- 10%)



Industrial Mercmaster™ LED Low Profile Luminaires For Ordinary Locations

NEC/CEC:
cULus Listed
Type 3R, 4, 4X
IP66
Suitable for Use in Wet Locations
Marine Outside Type (Salt Water)

	Hub Size	Lumen Level	With Type V Polycarbonate Globe ①	With Type V Polycarbonate Diffused Globe ①	Glass Globe ①②	With Type V Glass Refractor ①②
Pendant — One Hub						
	3/4	2K	IMLLEDA22P5	IMLLEDA22D5	IMLLEDA22G5	IMLLEDA22J5
	3/4	3K	IMLLEDA32P5	IMLLEDA32D5	IMLLEDA32G5	IMLLEDA32J5
	3/4	4K	IMLLEDA42P5	IMLLEDA42D5	IMLLEDA42G5	IMLLEDA42J5
	1	2K	IMLLEDA23P5	IMLLEDA23D5	IMLLEDA23G5	IMLLEDA23J5
	1	3K	IMLLEDA33P5	IMLLEDA33D5	IMLLEDA33G5	IMLLEDA33J5
	1	4K	IMLLEDA43P5	IMLLEDA43D5	IMLLEDA43G5	IMLLEDA43J5
Ceiling — Five Hubs, Four Close-up Plugs						
	3/4	2K	IMLLEDC22P5	IMLLEDC22D5	IMLLEDC22G5	IMLLEDC22J5
	3/4	3K	IMLLEDC32P5	IMLLEDC32D5	IMLLEDC32G5	IMLLEDC32J5
	3/4	4K	IMLLEDC42P5	IMLLEDC42D5	IMLLEDC42G5	IMLLEDC42J5
	1	2K	IMLLEDC23P5	IMLLEDC23D5	IMLLEDC23G5	IMLLEDC23J5
	1	3K	IMLLEDC33P5	IMLLEDC33D5	IMLLEDC33G5	IMLLEDC33J5
	1	4K	IMLLEDC43P5	IMLLEDC43D5	IMLLEDC43G5	IMLLEDC43J5
Pendant Cone — One hub, rigid mounting						
	3/4	2K	IMLLEDD22P5	IMLLEDD22D5	IMLLEDD22G5	IMLLEDD22J5
	3/4	3K	IMLLEDD32P5	IMLLEDD32D5	IMLLEDD32G5	IMLLEDD32J5
	3/4	4K	IMLLEDD42P5	IMLLEDD42D5	IMLLEDD42G5	IMLLEDD42J5
	1	2K	IMLLEDD23P5	IMLLEDD23D5	IMLLEDD23G5	IMLLEDD23J5
	1	3K	IMLLEDD33P5	IMLLEDD33D5	IMLLEDD33G5	IMLLEDD33J5
	1	4K	IMLLEDD43P5	IMLLEDD43D5	IMLLEDD43G5	IMLLEDD43J5

① For optional fusing, add suffix **-F** to the end of the catalog number.

② Guards for the glass refractors and globes are ordered separately. See following pages for accessory ordering information.



Industrial Mercmaster™ LED Low Profile Luminaires

For Ordinary Locations

NEC/CEC:
cULus Listed
Type 3R, 4, 4X
IP66
Suitable for Use in Wet Locations
Marine Outside Type (Salt Water)

Appleton®

LED/AREA: NEC/CEC ORDINARY LOCATION

	Hub Size	Lumen Level	With Type V Polycarbonate Globe ①	With Type V Polycarbonate Diffused Globe ①	Glass Globe ①②	With Type V Glass Refractor ①②
90° Stanchion — One hub						
	1 - 1/4	2K	IMLLEDR24P5	IMLLEDR24D5	IMLLEDR24G5	IMLLEDR24J5
	1 - 1/4	3K	IMLLEDR34P5	IMLLEDR34D5	IMLLEDR34G5	IMLLEDR34J5
	1 - 1/4	4K	IMLLEDR44P5	IMLLEDR44D5	IMLLEDR44G5	IMLLEDR44J5
	1 - 1/2	2K	IMLLEDR25P5	IMLLEDR25D5	IMLLEDR25G5	IMLLEDR25J5
	1 - 1/2	3K	IMLLEDR35P5	IMLLEDR35D5	IMLLEDR35G5	IMLLEDR35J5
	1 - 1/2	4K	IMLLEDR45P5	IMLLEDR45D5	IMLLEDR45G5	IMLLEDR45J5
25° Stanchion — One hub						
	1 - 1/4	2K	IMLLEDS24P5	IMLLEDS24D5	IMLLEDS24G5	IMLLEDS24J5
	1 - 1/4	3K	IMLLEDS34P5	IMLLEDS34D5	IMLLEDS34G5	IMLLEDS34J5
	1 - 1/4	4K	IMLLEDS44P5	IMLLEDS44D5	IMLLEDS44G5	IMLLEDS44J5
	1 - 1/2	2K	IMLLEDS25P5	IMLLEDS25D5	IMLLEDS25G5	IMLLEDS25J5
	1 - 1/2	3K	IMLLEDS35P5	IMLLEDS35D5	IMLLEDS35G5	IMLLEDS35J5
	1 - 1/2	4K	IMLLEDS45P5	IMLLEDS45D5	IMLLEDS45G5	IMLLEDS45J5
Wall — Five hubs, Four Close-Up Plugs						
	3/4	2K	IMLLEDW22P5	IMLLEDW22D5	IMLLEDW22G5	IMLLEDW22J5
	3/4	3K	IMLLEDW32P5	IMLLEDW32D5	IMLLEDW32G5	IMLLEDW32J5
	3/4	4K	IMLLEDW42P5	IMLLEDW42D5	IMLLEDW42G5	IMLLEDW42J5
	1	2K	IMLLEDW23P5	IMLLEDW23D5	IMLLEDW23G5	IMLLEDW23J5
	1	3K	IMLLEDW33P5	IMLLEDW33D5	IMLLEDW33G5	IMLLEDW33J5
	1	4K	IMLLEDW43P5	IMLLEDW43D5	IMLLEDW43G5	IMLLEDW43J5

① For optional fusing, add suffix -F to the end of the catalog number.

② Guards for the glass refractors and globes are ordered separately. See following pages for accessory ordering information.

Industrial Mercmaster™ LED Low Profile Luminaires For Ordinary Locations







NEC/CEC:
cULus Listed
Type 3R, 4, 4X
IP66
Suitable for Use in Wet Locations
Marine Outside Type (Salt Water)

Fixture Unit — Ballast Body and Globe or Refractor



Lumen Level	LED Wattage	Light Level Equivalent	NEMA Type	Catalog Number ①				
				For Polycarbonate Globe	For Polycarbonate Diffused Globe	Glass Globe ②	For Refractor ②	
cULus Listed Fixture Housing - For Ordinary Locations								
2K	26	70W HPS	Type V	IMLLED2P5BU	IMLLED2D5BU	IMLLED2G5BU	IMLLED2J5BU	
3K	35	100W HPS	Type V	IMLLED3P5BU	IMLLED3D5BU	IMLLED3G5BU	IMLLED3J5BU	
4K	48	150W HPS	Type V	IMLLED4P5BU	IMLLED4D5BU	IMLLED4G5BU	IMLLED4J5BU	

Mounting Hoods

	Description	Hub Size	Catalog Number
Pendant 	One Hub	3/4	KPA-75
		1	KPA-100
Pendant Cone 	One Hub, Rigid Mounting	3/4	KPCH-75
		1	KPCH-100
Ceiling 	Five Hubs, Four Close-Up Plugs	3/4	KPC-75
		1	KPC-100
Wall 	Five Hubs, Four Close-Up Plugs	3/4	KPWB-75
		1	KPWB-100
25° Stanchion 	One Hub	1-1/4	KPS-125
		1-1/2	KPS-150
90° Stanchion 	One Hub	1-1/4	KPST-125
		1-1/2	KPST-150

① BU - Universal Voltages 120-277 VAC, 50/60Hz

② Guards for the glass refractors and globes are ordered separately. See following pages for accessory ordering information.

Industrial Mercmaster™ LED Low Profile Luminaires

For Ordinary Locations

NEC/CEC:
 cULus Listed
 Type 3R, 4, 4X
 IP66
 Suitable for Use in Wet Locations
 Marine Outside Type (Salt Water)

Appleton

LED/AREA: NEC/CEC ORDINARY LOCATION

Replacement Parts

	Description	Catalog Number
--	-------------	----------------

Globes and Gaskets



Clear Globe (polycarbonate)

VPGL-LED



Diffused Globe (polycarbonate)

VPGL-DIFF



Glass Globe

VPGL-GLASS



Globe Gasket — Silicone Rubber

KRF-GK

	Light Distribution	Catalog Number
--	--------------------	----------------

Closed Prismatic Glass Refractors — All Heat-Resistant



Glass Refractor

NEMA Type V

LPG-R5

	Description	Catalog Number
--	-------------	----------------

LED Array

IMLLED2 Array assembly, Type V, 5700K

IMLLED2A5W

IMLLED3 Array assembly, Type V, 5700K

IMLLED3A5W

IMLLED4 Array assembly, Type V, 5700K

IMLLED4A5W

Drivers

120-277V Driver for IMLLED2 and IMLLED3

IMLLEDBU





120-277V Driver for IMLLED4

IMLLEDBU4

Industrial Mercmaster™ LED Low Profile Luminaires

For Ordinary Locations

NEC/CEC:
 cULus Listed
 Type 3R, 4, 4X
 IP66
 Suitable for Use in Wet Locations
 Marine Outside Type (Salt Water)

Accessories			
	Description	Catalog Number	
White Polyester Reflectors			
	30° Angle	CMR-4AN	
Guards			
	Glass Globe Guard	MGU1	
	Refractor Guard	KRG2	
Adapters			
	Adapter Assembly from V51 to MM III/LED Series	LPAD-1 ①	

① LPAD-1 adapter is not UL certified for use with IMLLED luminaires.

Industrial Mercmaster™ LED Low Profile Luminaires

For Ordinary Locations

NEC/CEC:
 cULus Listed
 Type 3R, 4, 4X
 IP66
 Suitable for Use in Wet Locations
 Marine Outside Type (Salt Water)

Dimensions With Polycarbonate Globe in Millimeters (Inches)

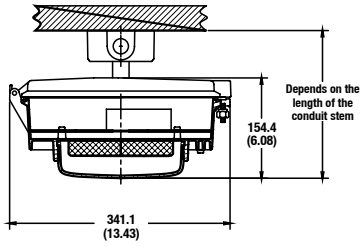

Pendant Mount

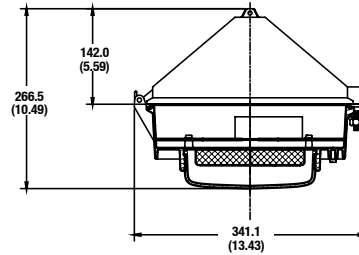

Pendant Cone Mount

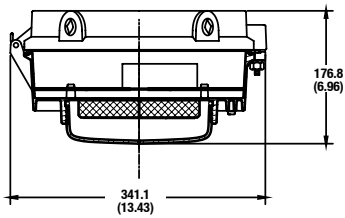

Ceiling Mount

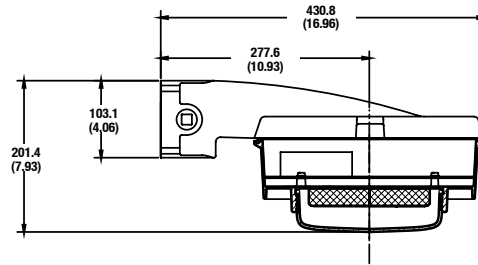

Wall Mount

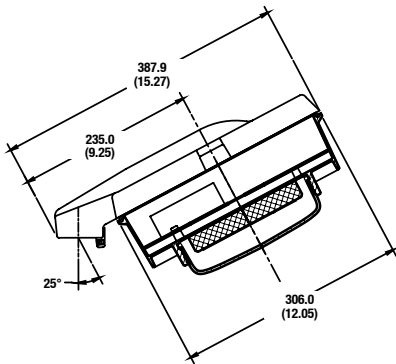

Angle Stanchion Mount

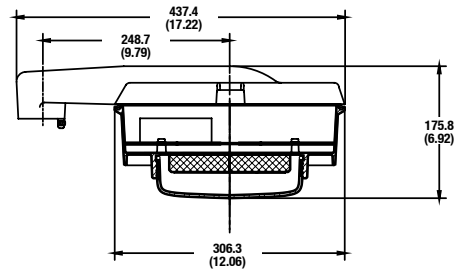

Stanchion Mount

Industrial Mercmaster™ LED Low Profile Luminaires For Ordinary Locations

NEC/CEC:
cULus Listed
Type 3R, 4, 4X
IP66
Suitable for Use in Wet Locations
Marine Outside Type (Salt Water)

Dimensions With Polycarbonate Globe in Millimeters (Inches)

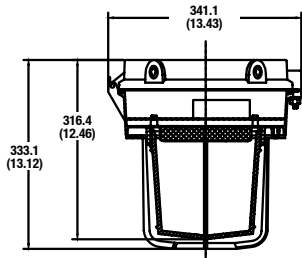

Ceiling Mount w/ Refractor and Guard

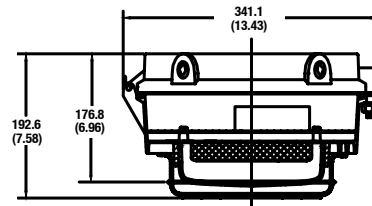

Ceiling Mount w/ Glass Globe and Guard

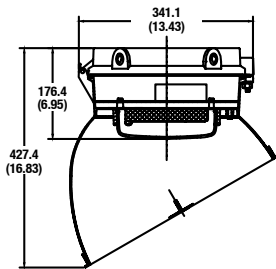

Ceiling Mount with Globe and 30° Reflector

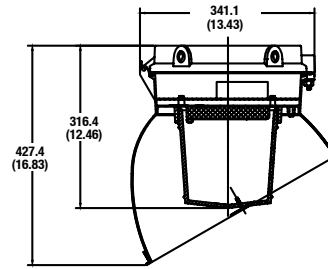

Ceiling Mount with Refractor and 30° Reflector

Mercmaster LED Low Profile Fixture and Mounting Hood Weights

Description	Weight kg (lb)
Fixture Unit (IMLLED2/IMLLED3)	4.1 (9.00)
Fixture Unit (IMLLED4)	4.6 (10.1)
Pendant Mounting Hood	1.0 (2.25)
Pendant Cone Mounting Hood	1.1 (2.50)
Ceiling Mounting Hood	1.4 (3.00)
Wall Mounting Hood	1.8 (4.00)
25° Stanchion Mounting Hood	1.5 (3.25)
90° Stanchion Mounting Hood	1.7 (3.75)

PC Series Industrial Photocontrol ^①

For Use in Ordinary Locations

For use with all Mercmaster III and Mercmaster LED luminaires

NEC/CEC:
Rated for Ordinary (Unclassified) Locations

Applications

- Durable polycarbonate housing with a clear UV stabilized window ultrasonically welded in place.
- Typical applications include walkways, security areas and any other outdoor lighting application.
- For use with all LED Series.
- For remote mounting in FS Boxes.



- Supplied with locknut and gasket.
- Specifications:
 - Turn on: 1 to 4 Fc
 - Turn off: 3 to 12 Fc
 - Time Delay: 30 seconds, minimum
 - Rated Life: 5,000 operation, minimum at rated load

Materials

- Photocell Housing: UV resistant polycarbonate
- FS Cover: aluminum

Features

- Solid state design for performance and reliability.
- Available for 120, 208, 240, or 277 volts.
- 1000 V.A.
- Minimum time delay: 15 seconds to eliminate nuisance tripping.
- Provided with (3) 18AWG stranded leads 152.4 mm (6.00 in) length.
- Will fit through standard 1/2" knockout.

	Voltage Range	Max VA	Max Current Amps	Suffix Designation Catalog Number
Factory Installed Photocontrol – Not for ceiling or pendant cone Add to fixture catalog after voltage; i.e.: IMLLEDA32P5BU5.				
 Mercmaster III wall mounting hood with photocontrol installed shown	120 V, 50/60 Hz	1000	—	5
	208 V, 50/60 Hz	1000	—	6
	240 V, 50/60 Hz	1000	—	7
	277 V, 50/60 Hz	1000	—	8
Photocontrol, purchased separately				
	120 V, 50/60 Hz	1000	8.3 Amp	PC120
	208 V, 50/60 Hz	1000	4.8 Amp	PC248
	240 V, 50/60 Hz	1000	4.2 Amp	
	277 V, 50/60 Hz	1000	3.6 Amp	
Photocontrol in FS Cover for Use with FS/FD Box Supplied with two stainless steel screws. For neoprene gasket, order catalog number FS-GKR-1N .				
	120 V, 50/60 Hz	1000	8.3 Amp	FSKA-PC120
	208 V, 50/60 Hz	1000	4.8 Amp	FSKA-PC247
	240 V, 50/60 Hz	1000	4.2 Amp	
	277 V, 50/60 Hz	1000	3.6 Amp	

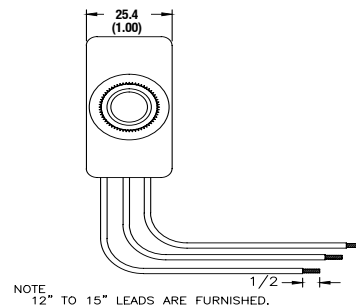
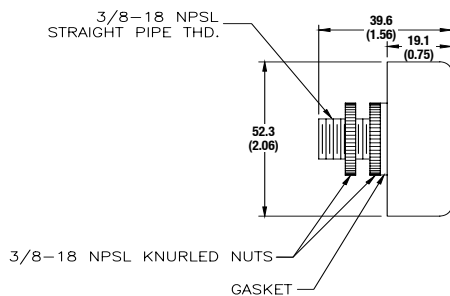

① Fixtures with photocontrols are rated Type 3R.

Industrial Mercmaster™ LED Low Profile Luminaires

For Ordinary Locations

NEC/CEC:
 cULus Listed
 Type 3R, 4, 4X
 IP66
 Suitable for Use in Wet Locations
 Marine Outside Type (Salt Water)

Photometric Data – DATA SHOWN IS ABSOLUTE

IMLLED2P5BU 2K Lumen 5700K CCT with Clear Polycarbonate Lens

Zonal Lumens and Percentages at 25°C

Zone	Lumens	% Luminaire	Zone	Lumens	% Luminaire
0-30	852.7	35.4	0-10	86.5	3.6
0-40	1423	59.2	10-20	280.4	11.7
0-60	2368	98.5	20-30	485.8	20.2
60-90	37.0	1.5	30-40	570.3	23.7
0-90	2406	100.0	40-50	573.0	23.8
90-180	0.0	0.0	50-60	372.5	15.5
0-180	2406	100.0	60-70	27.9	1.2
			70-80	7.0	0.3
			80-90	2.1	0.1

Polar Candela Distribution

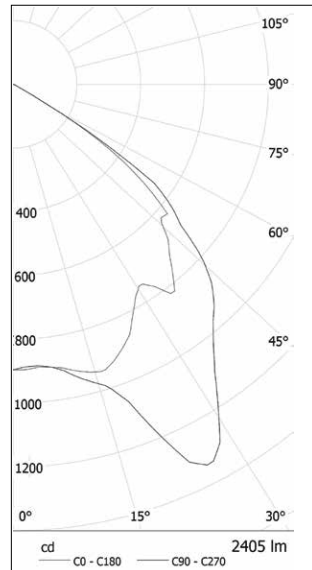

Isoillumination Plot

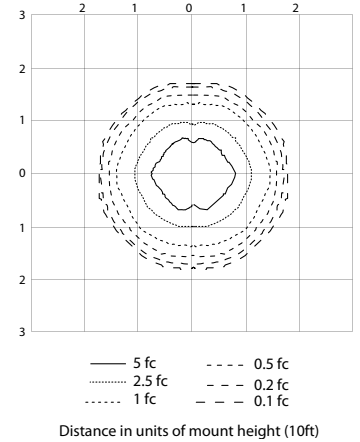

IMLLED2D5BU 2K Lumen 5700K CCT with Diffused Polycarbonate Lens

Zonal Lumens and Percentages at 25°C

Zone	Lumens	% Luminaire	Zone	Lumens	% Luminaire
0-30	788.1	34.3	0-10	85.9	3.7
0-40	1299	56.5	10-20	266.8	11.6
0-60	2092	90.9	20-30	435.4	18.9
60-90	194.5	8.5	30-40	510.6	22.2
0-90	2286	99.4	40-50	478.8	20.8
90-180	14.7	0.6	50-60	314.0	13.6
0-180	2301	100.0	60-70	130.7	5.7
			70-80	50.4	2.2
			80-90	13.4	0.6
			90-100	4.0	0.2
			100-110	9.5	0.4
			110-120	1.2	0.1

Polar Candela Distribution

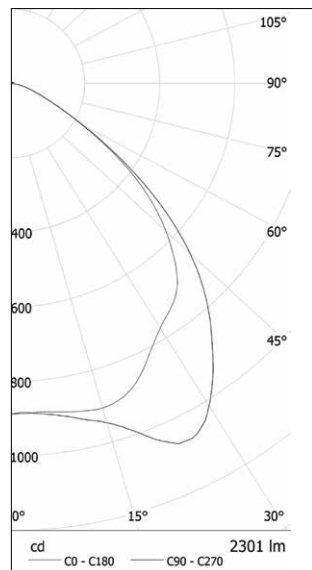

Isoillumination Plot

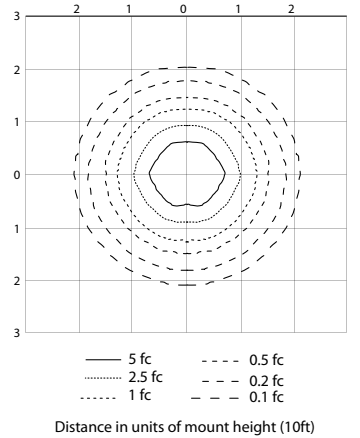

Industrial Mercmaster™ LED Low Profile Luminaires

For Ordinary Locations

NEC/CEC:
 cULus Listed
 Type 3R, 4, 4X
 IP66
 Suitable for Use in Wet Locations
 Marine Outside Type (Salt Water)

Photometric Data – DATA SHOWN IS ABSOLUTE

IMLLED2G5BU 2K Lumen 5700K CCT with Glass Globe

Zonal Lumens and Percentages at 25°C

Zone	Lumens	% Luminaire	Zone	Lumens	% Luminaire
0-30	896.4	35.5	0-10	90.7	3.6
0-40	1498	59.4	10-20	294.9	11.7
0-60	2490	98.7	20-30	510.7	20.2
60-90	33.4	1.3	30-40	601.9	23.9
0-90	2523	100.0	40-50	605.8	24.0
90-180	0.0	0.0	50-60	385.7	15.3
0-180	2523	100.0	60-70	26.1	1.0
			70-80	5.8	0.2
			80-90	1.4	0.1

Polar Candela Distribution

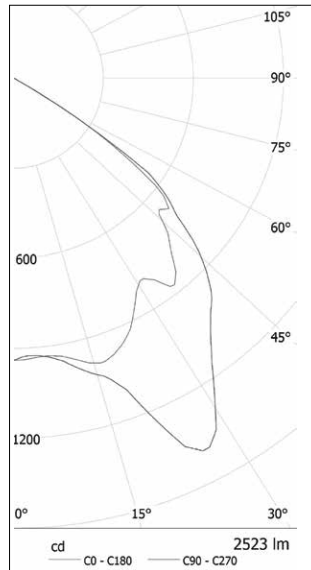

Isoillumination Plot

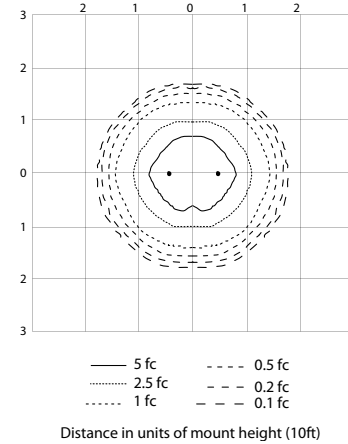

IMLLED2J5BU 2K Lumen 5700K CCT with Glass Refractor

Zonal Lumens and Percentages at 25°C

Zone	Lumens	% Luminaire	Zone	Lumens	% Luminaire
0-30	421.8	19.5	0-10	42.6	2.0
0-40	758.5	35.1	10-20	137.9	6.4
0-60	1612	74.6	20-30	241.3	11.2
60-90	287.7	13.3	30-40	336.8	15.6
0-90	1900	87.9	40-50	440.2	20.4
90-180	261.4	12.1	50-60	413.6	19.1
0-180	2161	100.0	60-70	155.1	7.2
			70-80	79.1	3.7
			80-90	53.5	2.5
			90-100	42.3	2.0
			100-110	43.7	2.0
			110-120	53.9	2.5
			120-130	60.8	2.8
			130-140	42.9	2.0
			140-150	16.4	0.8
			150-160	1.4	0.1

Polar Candela Distribution

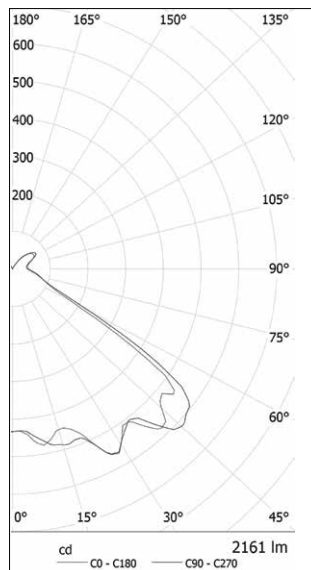

Isoillumination Plot

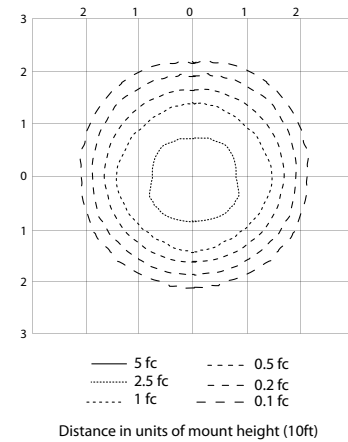

Industrial Mercmaster™ LED Low Profile Luminaires

For Ordinary Locations

NEC/CEC:
 cULus Listed
 Type 3R, 4, 4X
 IP66
 Suitable for Use in Wet Locations
 Marine Outside Type (Salt Water)

Photometric Data — DATA SHOWN IS ABSOLUTE

IMLLED3P5BU 3K Lumen 5700K CCT with Clear Polycarbonate Lens

Zonal Lumens and Percentages at 25°C

Zone	Lumens	% Luminaire	Zone	Lumens	% Luminaire
0-30	1161	34.1	0-10	121.6	3.6
0-40	1992	58.5	10-20	378.1	11.1
0-60	3358	98.5	20-30	660.9	19.4
60-90	49.5	1.5	30-40	831.4	24.4
0-90	3408	100.0	40-50	837.7	24.6
90-180	0.0	0.0	50-60	528.5	15.5
0-180	3408	100.0	60-70	37.7	1.1
			70-80	9.2	0.3
			80-90	2.6	0.1

Polar Candela Distribution

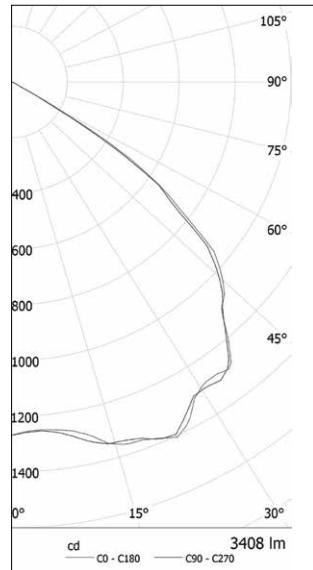

Isoillumination Plot

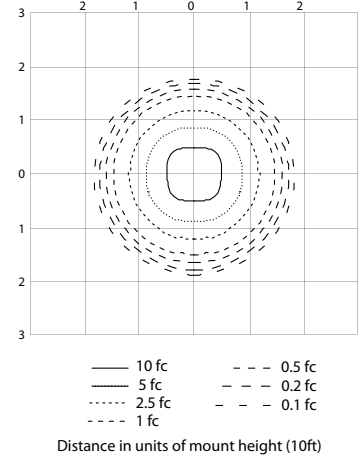

IMLLED3D5BU 3K Lumen 5700K CCT with Diffused Polycarbonate Lens

Zonal Lumens and Percentages at 25°C

Zone	Lumens	% Luminaire	Zone	Lumens	% Luminaire
0-30	1090	33.2	0-10	120.5	3.7
0-40	1827	55.6	10-20	366.3	11.1
0-60	2980	90.6	20-30	603.4	18.4
60-90	283.7	8.6	30-40	736.6	22.4
0-90	3263	99.3	40-50	698.3	21.2
90-180	24.6	0.7	50-60	454.6	13.8
0-180	3288	100.0	60-70	188.8	5.7
			70-80	73.6	2.2
			80-90	21.3	0.6
			90-100	7.3	0.2
			100-110	14.8	0.4
			110-120	2.5	0.1

Polar Candela Distribution

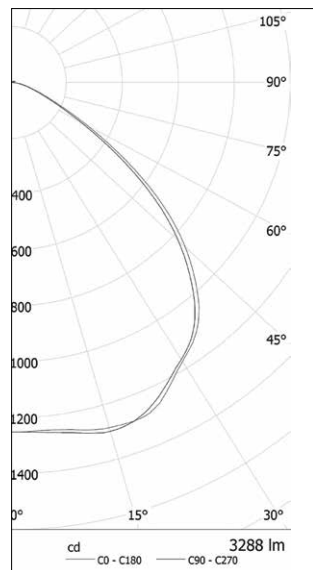

Isoillumination Plot

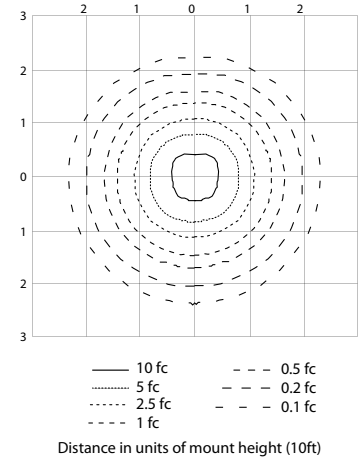

Industrial Mercmaster™ LED Low Profile Luminaires

For Ordinary Locations

NEC/CEC:
 cULus Listed
 Type 3R, 4, 4X
 IP66
 Suitable for Use in Wet Locations
 Marine Outside Type (Salt Water)

Photometric Data – DATA SHOWN IS ABSOLUTE

IMLLED3G5BU 3K Lumen 5700K CCT with Glass Globe

Zonal Lumens and Percentages at 25°C

Zone	Lumens	% Luminaire	Zone	Lumens	% Luminaire
0-30	1220	34.1	0-10	127.4	3.6
0-40	2095	58.6	10-20	397.2	11.1
0-60	3525	98.7	20-30	695.5	19.5
60-90	47.7	1.3	30-40	874.8	24.5
0-90	3573	100.0	40-50	880.9	24.7
90-180	0.0	0.0	50-60	549.3	15.4
0-180	3573	100.0	60-70	36.8	1.0
			70-80	8.5	0.2
			80-90	2.3	0.1

Polar Candela Distribution

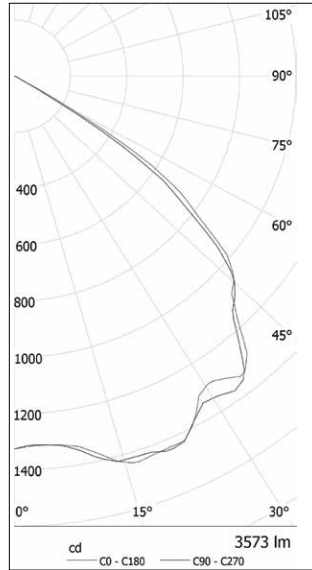

Isoillumination Plot

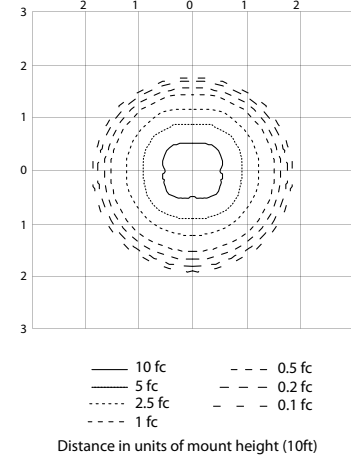

IMLLED3J5BU 3K Lumen 5700K CCT with Glass Refractor

Zonal Lumens and Percentages at 25°C

Zone	Lumens	% Luminaire	Zone	Lumens	% Luminaire
0-30	593.6	19.3	0-10	59.9	1.9
0-40	1069	34.7	10-20	194.1	6.3
0-60	2292	74.4	20-30	339.6	11.0
60-90	417.3	13.5	30-40	475.6	15.4
0-90	2709	87.9	40-50	622.0	20.2
90-180	372.4	12.1	50-60	601.0	19.5
0-180	3082	100.0	60-70	227.5	7.4
			70-80	113.1	3.7
			80-90	76.7	2.5
			90-100	60.6	2.0
			100-110	62.7	2.0
			110-120	76.1	2.5
			120-130	84.4	2.8
			130-140	61.2	2.0
			140-150	24.1	0.8
			150-160	2.2	0.1

Polar Candela Distribution

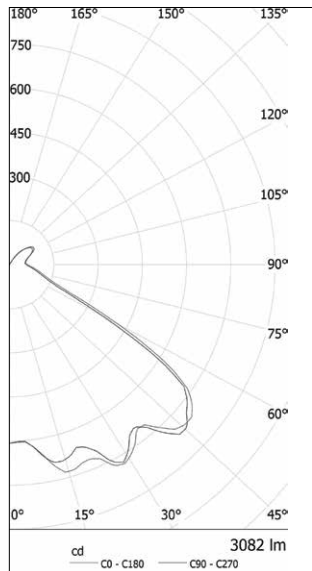

Isoillumination Plot

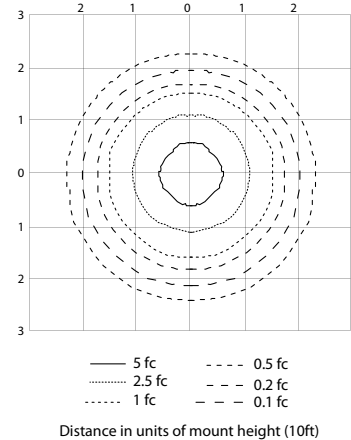

Industrial Mercmaster™ LED Low Profile Luminaires

For Ordinary Locations

NEC/CEC:
 cULus Listed
 Type 3R, 4, 4X
 IP66
 Suitable for Use in Wet Locations
 Marine Outside Type (Salt Water)



LED/AREA: NEC/CEC ORDINARY LOCATION

Photometric Data – DATA SHOWN IS ABSOLUTE

IMLLED4P5BU 4K Lumen 5700K CCT with Clear Polycarbonate Lens

Zonal Lumens and Percentages at 25°C

Zone	Lumens	% Luminaire	Zone	Lumens	% Luminaire
0-30	1676	34.9	0-10	171.9	3.6
0-40	2829	59.0	10-20	549.3	11.5
0-60	4705	98.1	20-30	954.3	19.9
60-90	89.7	1.9	30-40	1153	24.0
0-90	4795	100.0	40-50	1126	23.5
90-180	0.0	0.0	50-60	751.1	15.7
0-180	4795	100.0	60-70	63.9	1.3
			70-80	17.9	0.4
			80-90	7.8	0.2

Polar Candela Distribution

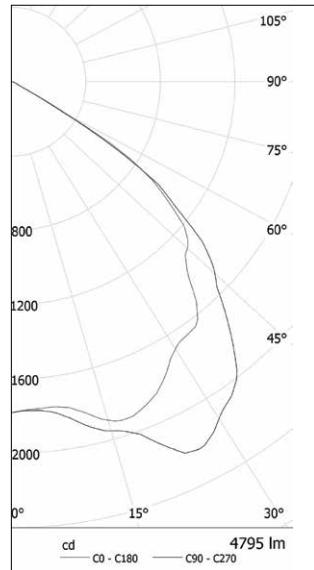

Isoillumination Plot

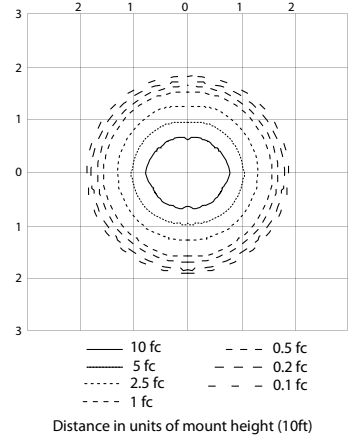

IMLLED4D5BU 4K Lumen 5700K CCT with Diffused Polycarbonate Lens

Zonal Lumens and Percentages at 25°C

Zone	Lumens	% Luminaire	Zone	Lumens	% Luminaire
0-30	1560	34.0	0-10	170.4	3.7
0-40	2583	56.2	10-20	526.5	11.5
0-60	4159	90.6	20-30	863.6	18.8
60-90	398.6	8.7	30-40	1022	22.3
0-90	4558	99.2	40-50	948.3	20.6
90-180	35.2	0.8	50-60	628.0	13.7
0-180	4593	100.0	60-70	266.2	5.8
			70-80	102.8	2.2
			80-90	29.6	0.6
			90-100	10.2	0.2
			100-110	21.6	0.5
			110-120	3.7	0.1

Polar Candela Distribution

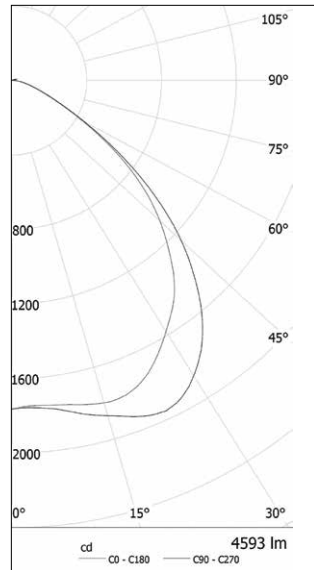

Isoillumination Plot

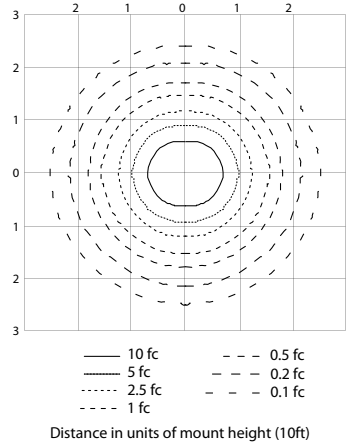

Industrial Mercmaster™ LED Low Profile Luminaires

For Ordinary Locations

NEC/CEC:

cULus Listed

Type 3R, 4, 4X

IP66

Suitable for Use in Wet Locations

Marine Outside Type (Salt Water)

Photometric Data — DATA SHOWN IS ABSOLUTE

IMLLED4G5BU 4K Lumen 5700K CCT with Glass Globe

Zonal Lumens and Percentages at 25°C

Zone	Lumens	% Luminaire	Zone	Lumens	% Luminaire
0-30	1748	35.1	0-10	178.5	3.6
0-40	2952	59.3	10-20	572.7	11.5
0-60	4906	98.6	20-30	997.0	20.0
60-90	71.5	1.4	30-40	1204	24.2
0-90	4977	100.0	40-50	1175	23.6
90-180	0.0	0.0	50-60	778.5	15.6
0-180	4977	100.0	60-70	57.6	1.2
			70-80	11.2	0.2
			80-90	2.6	0.1

Polar Candela Distribution

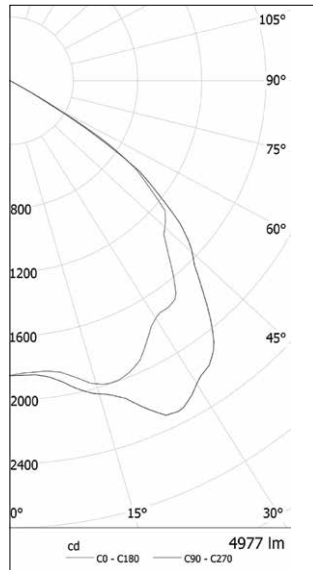

Isoillumination Plot

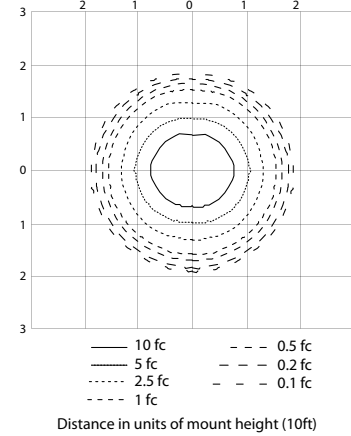

IMLLED4J5BU 4K Lumen 5700K CCT with Glass Refractor

Zonal Lumens and Percentages at 25°C

Zone	Lumens	% Luminaire	Zone	Lumens	% Luminaire
0-30	836.3	19.5	0-10	84.6	2.0
0-40	1501	35.0	10-20	274.6	6.4
0-60	3199	74.7	20-30	477.1	11.1
60-90	571.9	13.4	30-40	664.8	15.5
0-90	3771	88.0	40-50	871.2	20.3
90-180	512.5	12.0	50-60	826.7	19.3
0-180	4283	100.0	60-70	308.3	7.2
			70-80	156.7	3.7
			80-90	106.9	2.5
			90-100	84.6	2.0
			100-110	87.9	2.1
			110-120	105.6	2.5
			120-130	115.7	2.7
			130-140	82.9	1.9
			140-150	32.6	0.8
			150-160	3.2	0.1

Polar Candela Distribution

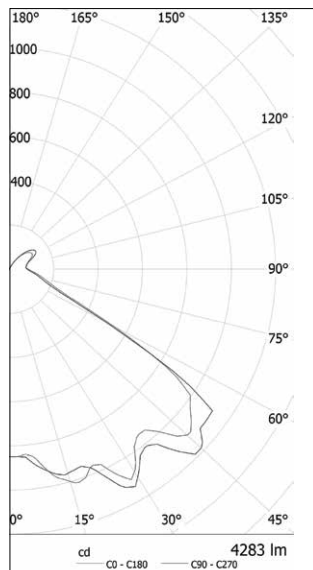

Isoillumination Plot

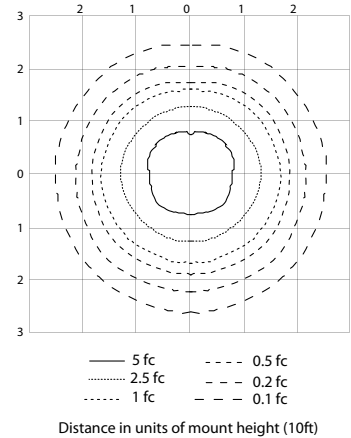

Areamaster™ LED Flood/High Bay Luminaires

For Hazardous Locations. 250 W, 400 W, 750 W HID Light Level Equivalent

NEC/CEC:
Class I, Division 2, Groups A,
B, C, D
Class I, Zone 2 Group IIC
Class II, Division 1, Groups
E, F, G

NEC/CEC:
Class II Division 2, Groups F, G
Class III
Simultaneous Exposure
Type 3R, 4, 4X
IP66/67

NEC:
Marine Outside Type
(Salt Water)
Wet Locations

ATEX/IECEX:
Zones 2 and 22
II 3 GD
EPL Gc and Dc
Ex nA IIC; Ex tc IIIC
IP66, IK08

ATEX/IECEX:
Zone 21
II 2 D
EPL Db
Ex tb IIIC
IK08

Applications

- Typical applications include:
 - Pulp and paper mills
 - Processing plants
 - Chemical plants
 - Oil refineries
 - Foundries
 - Food processing plants
 - Storage areas
 - Waste and sewage treatment
 - Parking garages
 - Other areas where water, dirt and rough usage are a problem

Features

- Compact in size, attractively styled contemporary design, rugged and dependable.
- Easy to install and service.
- One-piece housing.
- One-piece lens in hinged cover. Secured by four M6 captive stainless steel slotted hex-head bolts.
- Thermal shock- and impact-resistant glass lens standard.
- Diffused polycarbonate lens available as an option.
- Heavy duty, high temperature silicone rubber gasket, mechanically secured.
- Universal design for flood and high bay mounting.
- Floodlight Mounting:
 - Yoke mount, zinc plated steel yoke with architectural bronze polyester finish.
- High Bay Mounting:
 - (1) Conduit entry on back of luminaire with locking set screw.
 - Rotate yoke up or remove.
- Chain Mounting:
 - Mounts via eyebolts threaded into the corners of the fixture.
 - Available with chain mounting, or as an accessory.
 - Rotate yoke up or remove.
- Cool operating temperatures translate into long luminaire life.
- NEC/CEC versions available with a total of three (3) 3/4" NPT entries with integral bushings.
- ATEX/IECEX version provided with one (1) 3/4" NPT/M20 adapter and two (2) close up plugs.
- Two (2) 3/4" NPT aluminum close up plugs provided.
- Electrical:
 - NEC/CEC/ATEX/IECEX: 120-277 Vac, 50/60 Hz
 - NEC/CEC: 347-480 Vac, 50/60 Hz.; 250 Vdc available on AMLED77YBC.
- Terminal block (screw type for secure connection) can accept UL/CSA 24-10AWG and IEC 0.2 - 4 mm².

Standard Materials

- Housing and lens door: copperfree (4/10 of 1% max.) aluminum
- Gasket: silicone rubber
- Reflector: metallized high reflectance finish
- Yoke mount: zinc plated steel
- Bolts: stainless steel
- Close up plugs: (2) aluminum provided

Standard Finishes

- Housing, lens cover and yoke mount: architectural bronze polyester



Floodlight

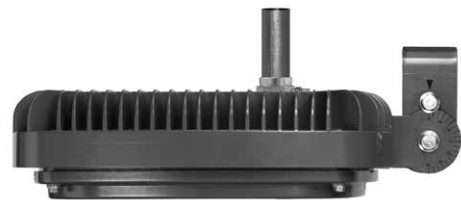

High Bay

Appleton

LED/FLOODLIGHTS: NEC/CEC, ATEX/IECEX ENCLOSED AND GASKETED

Areamaster™ LED Flood/High Bay Luminaires

For Hazardous Locations. 250 W, 400 W, 750 W HID Light Level Equivalent

NEC/CEC:
 Class I, Division 2, Groups A, B, C, D
 Class I, Zone 2 Group IIC
 Class II, Division 1, Groups E, F, G

NEC/CEC:
 Class II Division 2, Groups F, G
 Class III
 Simultaneous Exposure
 Type 3R, 4, 4X
 IP66/67

NEC:
 Marine Outside Type
 (Salt Water)
 Wet Locations

ATEX/IECEX:
 Zones 2 and 22
 Ⓢ II 3 GD
 EPL Gc and Dc
 Ex nA IIC; Ex tc IIIC
 IP66, IK08

ATEX/IECEX:
 Zone 21
 Ⓢ II 2 D
 EPL Db
 Ex tb IIIC
 IK08

NEC/CEC Certifications and Compliances

- UL Standard: UL 1598, UL 1598A, UL 8750, UL 844
- CSA Standard: C22.2 No. 250.0, C22.2 No. 137
- cCASus Certified: 065182
- Ambient Temperature: AMLED67 and AMLED77 -40 °C to +65 °C (-40 °F to +149 °F); AMLED87 -40 °C to +55 °C (-40 °F to +131 °F)
- The Class II, Division 1 & 2, Class III & Simultaneous Exposure Restrictions: 30° Rotation Maximum
 - The luminaire may be rotated a maximum of 30 degrees from the vertical plane such that the lens will be facing down (see 30° rotation picture).
 - The luminaire must not be rotated such that the lens will be facing up at any angle. Also, for fixtures with glass lens only and not for chain-mounted or pendant-mounted fixtures.



30° Rotation

ATEX/IECEX Certifications and Compliances

- Certification Type AMLED
 - Gas: Zone 2
 - Conforming to ATEX 94/9/EC: Ⓢ II 3 G
 - Protection Level: EPL Gc
 - Type of Protection: Ex nA IIC
 - Temperature class: See Table on following page
 - Dust: Zones 21 and 22
 - Conforming to ATEX 94/9/EC: Ⓢ II 2 D and II 3D
 - Protection Level: EPL Db and Dc
 - Type of Protection: Ex tb IIIC and Ex tc IIIC
 - Temperature class: See Table on following page
- EC Declaration of Conformity: 50307
- ATEX Certificate: LCIE 14 ATEX 1016X (Zone 2/22), LCIE 14 ATEX 3049X (Zone 21)
- IECEx Certificate: IECEx LCIE 14.0030X
- Ambient Temperature: -40 °C to +55 °C (-40 °F to +131 °F)
- Index of Protection according EN/IEC 60529: IP66
- Impact Resistance (shock): IK08

EURASEC Certification

- EURASEC N° TC RU C-FR.Г505.B.00912

DesignLights™ Consortium (for the following models)

- AMLED67YBU1
- AMLED67YBU1D
- AMLED77YBU1
- AMLED77YBU1D
- AMLED87YBU1
- AMLED87YBU1D

Areamaster™ LED Flood/High Bay Luminaires

For Hazardous Locations. 250 W, 400 W, 750 W HID Light Level Equivalent

NEC/CEC:
Class I, Division 2, Groups A, B, C, D
Class I, Zone 2 Group IIC
Class II, Division 1, Groups E, F, G

NEC/CEC:
Class II Division 2, Groups F, G
Class III
Simultaneous Exposure
Type 3R, 4, 4X
IP66/67

NEC:
Marine Outside Type
(Salt Water)
Wet Locations

ATEX/IECEX:
Zones 2 and 22
Ⓢ II 3 GD
EPL Gc and Dc
Ex nA IIC; Ex tc IIIC
IP66, IK08

ATEX/IECEX:
Zone 21
Ⓢ II 2 D
EPL Db
Ex tb IIIC
IK08

Order using catalog numbering guide below or select catalog number from tables on following pages.

Catalog Numbering Guide – NEC/CEC and ATEX/IECEX Certified Areamaster LED

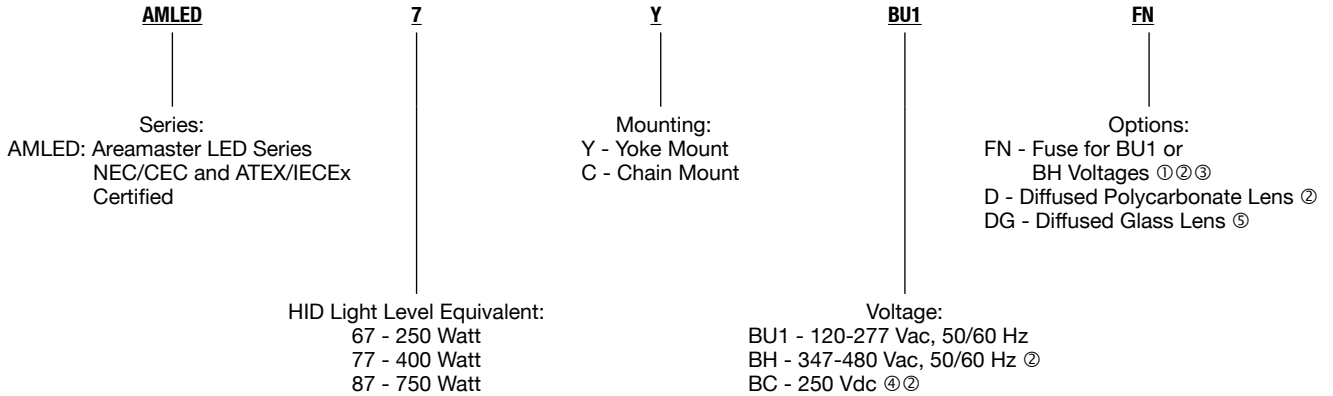

① Not available for use on the 750 Watt equivalent.

② Not available for use on the ATEX/IECEX certified fixtures.

③ Canadian Electrical Code does NOT allow fusing in hazardous locations. Fuse not CEC rated.

④ Not available for use on the 250 and 750 Watt equivalent.

⑤ For ATEX/IECEX versions.

Areamaster™ LED Flood/High Bay Luminaires

For Hazardous Locations. 250 W, 400 W, 750 W HID Light Level Equivalent

NEC/CEC:
Class I, Division 2, Groups A, B, C, D
Class I, Zone 2 Group IIC
Class II, Division 1, Groups E, F, G

NEC/CEC:
Class II Division 2, Groups F, G
Class III
Simultaneous Exposure
Type 3R, 4, 4X
IP66/67

NEC:
Marine Outside Type
(Salt Water)
Wet Locations

ATEX/IECEX:
Zones 2 and 22
Ⓢ II 3 GD
EPL Gc and Dc
Ex nA IIC; Ex tc IIIC
IP66, IK08

ATEX/IECEX:
Zone 21
Ⓢ II 2 D
EPL Db
Ex tb IIIC
IK08

Technical Data – NEC/CEC

Lamp		Ambient Temperature °C (°F)	Supply Wire Temperature °C (°F)	Class I, Division 2 ①	Gas Groups	ExnA IIC AExnA IIC	Dust Class II, Division 1 Groups E,F,G	Catalog Number
Line Voltage	Type							
120-277 Vac	LED	40 (104)	75 (167)	T4	A,B,C,D	T4	T6	AMLED67YBU1
		55 (131)	90 (194)	T3C	A,B,C,D	T3	T6	
		65 (149)	90 (194)	T3C	A,B,C,D	T3	T5	
347-480 Vac	LED	40 (104)	75 (167)	T4	A,B,C,D	—	T6	AMLED67YBH
		55 (131)	75 (167)	T3C	A,B,C,D	—	—	
120-277 Vac	LED	40 (104)	75 (167)	T4	A,B,C,D	T4	T6	AMLED77YBU1
		55 (131)	90 (194)	T3C	A,B,C,D	T3	T5	
		65 (149)	105 (221)	T3C	A,B,C,D	T3	T4A	
347-480 Vac	LED	40 (104)	75 (167)	T4	A,B,C,D	—	T6	AMLED77YBH
250 Vdc	LED	40 (104)	75 (167)	T4A	A,B,C,D	T4	T5	AMLED77YBC
120-277 Vac	LED	40 (104)	75 (167)	T3C	A,B,C,D	T3	T4A	AMLED87YBU1
		55 (131)	90 (194)	T3A	A,B,C,D	T3	T5	
347-480 Vac	LED	40 (104)	75 (167)	T3	A,B,C,D	—	T5	AMLED87YBH

Technical Data – ATEX/IECEX – Ambient Temperature Ta °C (°F)

GAS (Zone 2) ①						DUST (Zones 21–22) ②						Catalog Number
40 (104)	55 (131)	40 (104)	55 (131)	40 (104)	55 (131)	40 (104)	55 (131)	40 (104)	55 (131)	40 (104)	55 (131)	
Downward		Wall Mounting		Upward		Downward		Wall Mounting		Upward		
T4 114 (237)	T4 129 (264)	T4 109 (228)	T4 124 (255)	T4 117 (243)	T3 132 (270)	68 (154)	83 (181)	67 (153)	82 (180)	70 (158)	85 (185)	AMLED67YBU1
T3 144 (291)	T3 159 (318)	T3 146 (295)	T3 161 (322)	T3 150 (302)	T3 165 (329)	75 (167)	90 (194)	74 (165)	89 (192)	77 (171)	92 (198)	AMLED77YBU1
T3 178 (352)	T3 193 (379)	T3 176 (349)	T3 191 (376)	T3 183 (361)	T2 198 (388)	83 (181)	98 (208)	82 (180)	97 (207)	87 (198)	102 (216)	AMLED87YBU1

“T” Numbers Represent the Maximum Internal Temperature ① or Maximum Surface Temperature ②

“T” #	NEC/CEC															
	T1	350	325	T2	T2A	T2B	T2C	T2D	T3	T3A	T3B	T3C	T4	T4A	T5	T6
Temp. Range °C (°F)	351-450 (664-842)	326-350 (619-662)	301-325 (574-617)	281-300 (538-572)	261-280 (502-536)	231-260 (448-500)	216-230 (421-446)	201-215 (394-419)	181-200 (358-392)	166-180 (331-356)	161-165 (322-329)	136-160 (277-320)	121-135 (250-275)	101-120 (214-248)	86-100 (187-212)	85 (185)
“T” #	ATEX/IECEX															
	T1	T2				T3				T4		T5	T6			
Temp. Range °C (°F)	301-450 (547-842)	201-300 (394-572)				136-200 (277-392)				101-135 (214-275)		86-100 (187-212)	85 (185)			

① T numbers represent the maximum internal temperature for Class I, Division 2 and Class I, Zone 2 locations designated by the NEC and ATEX/IECEX.

② T numbers represent the maximum surface temperature under a dust blanket for Class II, Division 1 and 2 as designated by the NEC or Zone 2 (Gas) and 22 (Dust) locations as designated by the IEC.

Areamaster™ LED Flood/High Bay Luminaires

For Hazardous Locations. 250 W, 400 W, 750 W HID Light Level Equivalent

NEC/CEC:
Class I, Division 2, Groups A, B, C, D
Class I, Zone 2 Group IIC
Class II, Division 1, Groups E, F, G

NEC/CEC:
Class II Division 2, Groups F, G
Class III
Simultaneous Exposure
Type 3R, 4, 4X
IP66/67

NEC:
Marine Outside Type
(Salt Water)
Wet Locations

ATEX/IECEX:
Zones 2 and 22
Ex II 3 GD
EPL Gc and Dc
Ex nA IIC; Ex tc IIIC
IP66, IK08

ATEX/IECEX:
Zone 21
Ex II 2 D
EPL Db
Ex tb IIIC
IK08

Electrical Specifications – Flood Mount

Voltage Range	Frequency (Hz)	Watts Input Power (Nom.)	Input Amps (Max.)	Total Harmonic Distortion	Power Factor	CRI	Color Temp CCT	Catalog Number
120-277 Vac	50/60	86/85	0.72 - 0.35	0.5	> 0.98	70	5650K	AMLED67YBU1
347-480 Vac	50/60	88/90	0.27 - 0.22	0.5	> 0.95	70	5650K	AMLED67YBH
120-277 Vac	50/60	125/121	1.10 - 0.47	0.5	> 0.98	70	5650K	AMLED77YBU1
347-480 Vac	50/60	124/125	0.37 - 0.29	0.5	> 0.95	70	5650K	AMLED77YBH
250 Vdc	—	118	0.47	0.5	> 0.98	70	5650K	AMLED77YBC
120-277 Vac	50/60	174/169	1.60 - 0.70	0.5	> 0.98	70	5700K	AMLED87YBU1
347-480 Vac	50/60	176/175	0.52 - 0.39	0.5	> 0.95	70	5700K	AMLED87YBH

Line Voltage	Catalog Number	
	NEC/CEC	ATEX/IECEX
120-277 Vac, 50/60 Hz	AMLED67YBU1	AMLED67YBU1
120-277 Vac, 50/60 Hz	AMLED77YBU1	AMLED77YBU1
120-277 Vac, 50/60 Hz	AMLED87YBU1	AMLED87YBU1
347-480 Vac, 50/60 Hz	AMLED67YBH	—
347-480 Vac, 50/60 Hz	AMLED77YBH	—
250 Vdc	AMLED77YBC	—
347-480 Vac, 50/60 Hz	AMLED87YBH	—



Appleton

LED/FLOODLIGHTS: NEC/CEC, ATEX/IECEX ENCLOSED AND GASKETED

Areamaster™ LED Flood/High Bay Luminaires

For Hazardous Locations. 250 W, 400 W, 750 W HID Light Level Equivalent

NEC/CEC:
Class I, Division 2, Groups A, B, C, D
Class I, Zone 2 Group IIC
Class II, Division 1, Groups E, F, G





NEC/CEC:
Class II Division 2, Groups F, G
Class III
Simultaneous Exposure
Type 3R, 4, 4X
IP66/67

NEC:
Marine Outside Type
(Salt Water)
Wet Locations

ATEX/IECEX:
Zones 2 and 22
II 3 GD
EPL Gc and Dc
Ex nA IIC; Ex tc IIIC
IP66, IK08

ATEX/IECEX:
Zone 21
II 2 D
EPL Db
Ex tb IIIC
IK08

Accessories and Replacement Parts

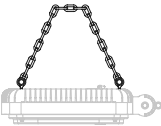
Description		Catalog Number NEC/CEC, ATEX/IECEX	
Crossarm Mounting Bracket			
	Has 180° horizontal adjustment — degree marked. Facilitates mounting floodlight to crossarm or other flat surface, or to G-AM-8-WB. Includes floodlight yoke bolts. Malleable iron, zinc plated, chromate sealed, architectural bronze polyester finish.	G-AM-8-CA	
Pipe or Wall Mount Bracket			
	Used with G-AM-8-CA. Clamps to 1" to 2-1/2" pipe, vertical or horizontal, or mounts on flat surfaces. Includes U-bolt and crossarm bracket bolts. Malleable iron, zinc plated, chromate sealed, with architectural bronze polyester finish.	G-AM-8-WB	
Poletop Slip-Fitter			
	Slip-fits 1-1/2" or 2" pipe size poletop tenons. Includes floodlight yoke bolts, 3 locking bolts, and cord grip. Body is malleable iron-zinc plated, chromate sealed, with cast aluminum cap. Assembly has architectural bronze polyester finish.	G-SF20	
	Slip-fits 1" or 1-1/2" pipe size poletop tenons. Includes floodlight yoke bolts, 3 locking bolts, and cord grip. Body is malleable iron-zinc plated, chromate sealed, with cast aluminum cap. Assembly has architectural bronze polyester finish.	AMLEDSF1	
Poletop Slip-Fitter			
	Slip-fits 2" or 2-1/2" poletop tenons. Includes floodlight yoke bolts, 3 locking bolts, and cord grip. Malleable iron, zinc plated, chromate sealed, with architectural bronze polyester finish.	G-AM-8-SF	
Chain			
	Chain mount assembly comes with two (2) 914.4 mm (36 inch) long chains, four (4) eye bolts, four (4) hex bolts, four (4) lock washers, four (4) hex nuts, eight (8) plain washers and an instruction sheet for complete assembly and mounting. Chains are galvanized steel, eye bolts are zinc plated steel, all other hardware is stainless steel.	AMLEDCM	
Description		Catalog Number NEC/CEC	Catalog Number ATEX/IECEX
LED Array			
With White LED's for the AMLED67		AMLED67AW	AMLED67AW
With White LED's for the AMLED77		AMLED77AW	AMLED77AW
With White LED's for the AMLED87		AMLED87AW	AMLED87AW
Drivers			
120 - 277 Vac — BU Version and BC Version		AMLED77DBU	—
120 - 277 Vac — BU1 Version — AMLED87: Left Side — AMLED67, AMLED77		AMLEDDBU1L	AMLEDDBU1L
120 - 277 Vac — BU1 Version — AMLED87: Right Side		AMLEDDBU1R	AMLEDDBU1R
347 - 480 Vac — BH Version — AMLED67, AMLED77		AMLED77DBH	—
347 - 480 Vac — BH Version — AMLED87: Left Side		AMLED87DBHL	—
347 - 480 Vac — BH Version — AMLED87: Right Side		AMLED87DBHR	—
Door Assembly			
With a Glass Lens, Pins		AMLEMDDOOR	AMLEMDDOOR
With a Polycarbonate Lens, Pins		AMLEMDDOORP	—

Appleton

LED/FLOODLIGHTS: NEC/CEC, ATEX/IECEX ENCLOSED AND GASKETED

Areamaster™ LED Flood/High Bay Luminaires

For Hazardous Locations. 250 W, 400 W, 750 W HID Light Level Equivalent

NEC/CEC:
 Class I, Division 2, Groups A,
 B, C, D
 Class I, Zone 2 Group IIC
 Class II, Division 1, Groups
 E, F, G

NEC/CEC:
 Class II Division 2, Groups F, G
 Class III
 Simultaneous Exposure
 Type 3R, 4, 4X
 IP66/67

NEC:
 Marine Outside Type
 (Salt Water)
 Wet Locations

ATEX/IECEX:
 Zones 2 and 22
 Ⓜ II 3 GD
 EPL Gc and Dc
 Ex nA IIC; Ex tc IIIC
 IP66, IK08

ATEX/IECEX:
 Zone 21
 Ⓜ II 2 D
 EPL Db
 Ex tb IIIC
 IK08

Dimensions in Millimeters (Inches)

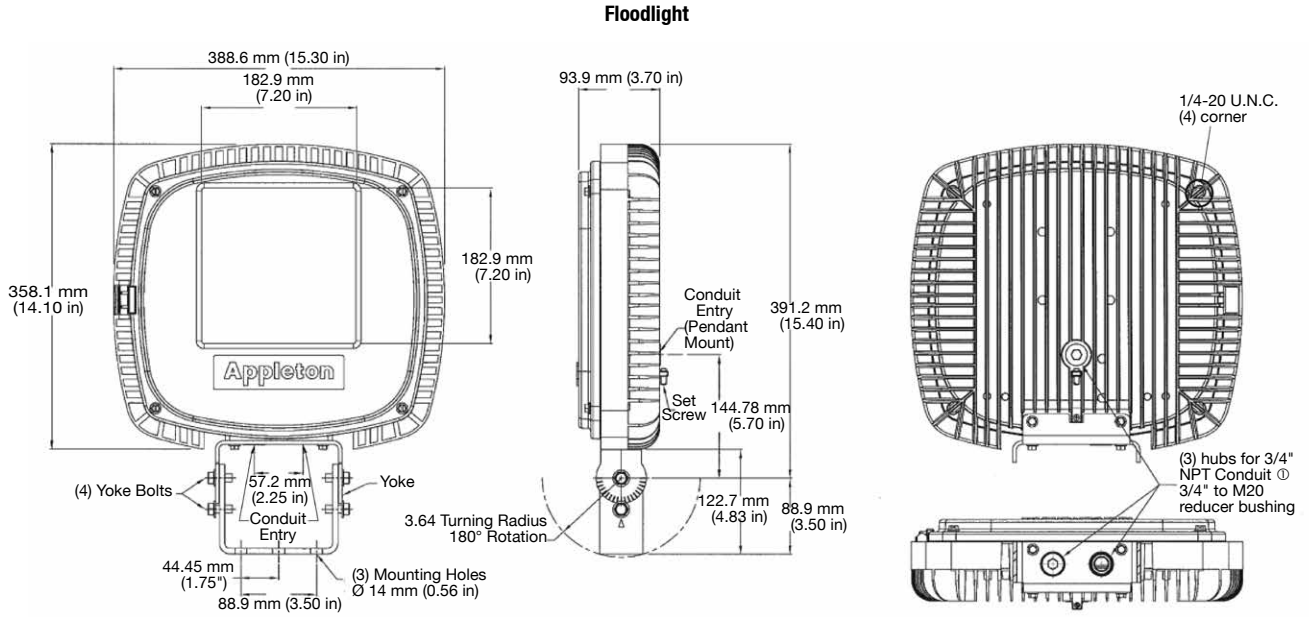

High Bay Pendant Mount

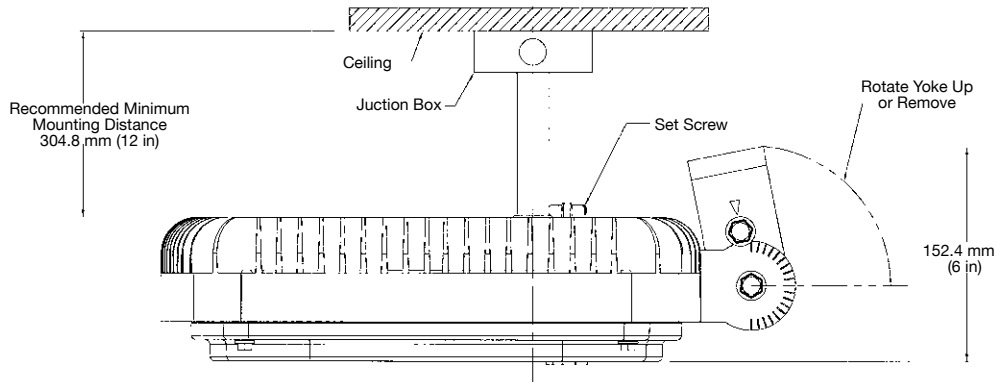

Ⓜ 3/4" NPT/M20 adapter supplied for ATEX version.

Areamaster™ LED Flood/High Bay Luminaires

For Hazardous Locations. 250 W, 400 W, 750 W HID Light Level Equivalent

NEC/CEC:
 Class I, Division 2, Groups A, B, C, D
 Class I, Zone 2 Group IIC
 Class II, Division 1, Groups E, F, G

NEC/CEC:
 Class II Division 2, Groups F, G
 Class III
 Simultaneous Exposure
 Type 3R, 4, 4X
 IP66/67

NEC:
 Marine Outside Type
 (Salt Water)
 Wet Locations

ATEX/IECEX:
 Zones 2 and 22
 II 3 GD
 EPL Gc and Dc
 Ex nA IIC; Ex tc IIIC
 IP66, IK08

ATEX/IECEX:
 Zone 21
 II 2 D
 EPL Db
 Ex tb IIIC
 IK08

Photometric Data – DATA SHOWN IS ABSOLUTE

REPORT NUMBER: **AMLED67YBU1_FLOOD**

Lamps: Areamaster, High Bay Mount, LED Board 39 LEDs, Specular Reflector 6–1/2 X 6–1/2 Tapered To 3–1/2 X 3–1/2, Lens Clear

Luminaire Lumens 8238

POLAR CANDELA DISTRIBUTION

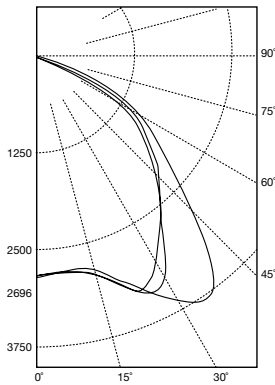

ISOCANDELA CURVES

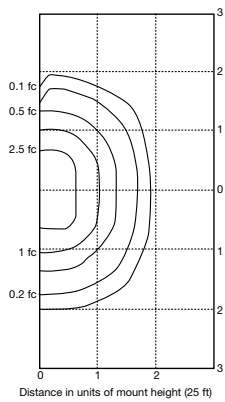

Zonal Lumen and Percentage at 25 °C (77 °F)

Zone	Lumens	% Lamp	% Fixture
0-10	245.6	N.A.	3.0
10-20	771.8	N.A.	9.4
20-30	1431	N.A.	17.4
30-40	1842	N.A.	22.4
40-50	1785	N.A.	21.7
50-60	1448	N.A.	17.6
60-70	667.1	N.A.	8.1
70-80	43.8	N.A.	0.5
80-90	4.5	N.A.	0.1

REPORT NUMBER: **AMLED67YBU1_Highbay**

Lamps: Areamaster, High Bay Mount, LED Board 39 LEDs, Specular Reflector 6–1/2 X 6–1/2 Tapered To 3–1/2 X 3–1/2, Lens Clear

POLAR CANDELA DISTRIBUTION

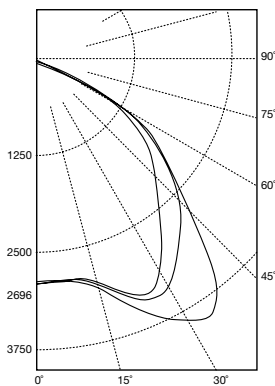

Zonal Lumen Summary and Percentage at 25 °C (77 °F)

Zone	Lumens	% Lamp	% Fixture
0-30	2434	N.A.	29.2
0-40	4283	N.A.	51.6
0-60	7553	N.A.	90.6
60-90	780	N.A.	9.4
0-90	8333	N.A.	100.0
90-180	0	N.A.	0
0-180	8333	N.A.	100.0

Zonal Lumen and Percentage at 25 °C (77 °F)

Zone	Lumens	% Lamp	% Fixture
0-10	244.8	N.A.	2.9
10-20	764.2	N.A.	9.2
20-30	1425	N.A.	17.1
30-40	1849	N.A.	22.2
40-50	1787	N.A.	21.4
50-60	1483	N.A.	17.8
60-70	731.0	N.A.	8.8
70-80	46.7	N.A.	0.6
80-90	2.4	N.A.	0.0

Areamaster™ LED Flood/High Bay Luminaires

For Hazardous Locations. 250 W, 400 W, 750 W HID Light Level Equivalent

NEC/CEC:
Class I, Division 2, Groups A, B, C, D
Class I, Zone 2 Group IIC
Class II, Division 1, Groups E, F, G

NEC/CEC:
Class II Division 2, Groups F, G
Class III
Simultaneous Exposure
Type 3R, 4, 4X
IP66/67

NEC:
Marine Outside Type
(Salt Water)
Wet Locations

ATEX/IECEX:
Zones 2 and 22
II 3 GD
EPL Gc and Dc
Ex nA IIC; Ex tc IIIC
IP66, IK08

ATEX/IECEX:
Zone 21
II 2 D
EPL Db
Ex tb IIIC
IK08

Photometric Data — DATA SHOWN IS ABSOLUTE

REPORT NUMBER: **AMLED77YBU1_FLOOD**

Lamps: Areamaster, High Bay Mount, LED Board 56 LEDs, Specular Reflector 6–1/2 X 6–1/2 Tapered To 3–1/2 X 3–1/2, Lens Clear

Characteristics: Maximum Candela: 5818; Maximum Candela Angle: 22.5 H 25.5 V; Horizontal Beam Angle (50%): 97.0; Vertical Beam Angle (50%): 102; Horizontal Field Angle (10%): 134; Vertical Field Angle (10%): 134; Beam Lumens 10414; Field Lumens 12967; Luminaire Lumens 13157

AXIAL CANDELA		
DEG.	HOR.	VERT.
90.0	0	0
85.0	21	2
75.0	26	5
65.0	700	733
55.0	2400	2341
47.5	3023	2976
42.5	3375	3307
37.5	3838	3826
33.0	4312	4319
29.0	4670	4719
25.5	4964	4898
22.5	4910	4857
19.5	4700	4660
17.0	4456	4343
15.0	4273	4249
13.0	4184	4165
11.0	4154	4123
9.0	4139	4105
7.0	4124	4119
5.0	4127	4133
3.0	4138	4150
1.0	4149	4153
0.0	4149	4149

AXIAL CANDELA DISPLAY

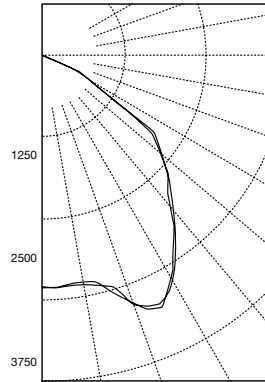

ISOCANDELA CURVES

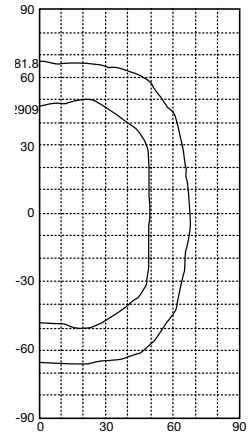

CIE Type – Direct

Plane	Spacing Criteria
0 Deg	1.5
90 Deg	1.5

Zone	Lumens
0-5	98
5-10	290
10-15	485
15-20	711
20-25	993
25-30	1264
30-35	1440
35-40	1517
40-45	1471
45-50	1392
50-55	1283
55-60	1086
60-65	764
65-70	340
70-75	37
75-80	4
80-85	2
85-90	1

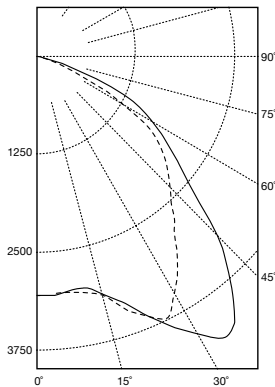

REPORT NUMBER: **AMLED77YBU1_Highbay**

Lamps: Areamaster, High Bay Mount, LED Board 56 LEDs, Specular Reflector 6–1/2 X 6–1/2 Tapered To 3–1/2 X 3–1/2, Lens Clear

Coefficients of Utilization – Zonal Cavity Method

		Effective Floor Cavity Reflectance 0.20																											
		80				70				50				30				10				0							
% Ceiling	Rcc	70	50	30	10	70	50	30	10	70	50	30	10	70	50	30	10	70	50	30	10	70	50	30	10	70	50	30	10
0	119	119	119	119	116	116	116	116	111	111	111	111	106	106	106	102	102	102	102	102	102	102	102	102	102	102	102	102	
1	111	107	103	100	108	105	102	99	101	98	96	97	95	93	93	92	90	88	88	83	79	83	80	78	76	76	76	76	
2	102	95	89	84	99	93	88	83	90	85	81	86	83	79	83	80	78	76	76	76	76	76	76	76	76	76	76	76	
3	94	84	77	71	91	83	76	70	80	74	69	77	72	68	75	70	67	65	65	65	65	65	65	65	65	65	65	65	
4	86	75	67	61	84	74	66	60	71	65	59	69	63	59	67	62	58	56	56	56	56	56	56	56	56	56	56	56	
5	79	67	59	52	77	66	58	52	64	57	52	62	56	51	60	55	50	48	48	48	48	48	48	48	48	48	48	48	
6	73	60	52	46	71	59	51	45	58	50	45	56	50	45	54	49	44	42	42	42	42	42	42	42	42	42	42	42	
7	67	54	46	40	66	54	46	40	52	45	40	51	44	39	49	44	39	37	37	37	37	37	37	37	37	37	37	37	
8	63	50	41	36	61	49	41	36	48	40	35	46	40	35	45	39	35	33	33	33	33	33	33	33	33	33	33	33	
9	58	45	37	32	57	45	37	32	44	37	32	43	36	31	42	36	31	30	30	30	30	30	30	30	30	30	30	30	
10	55	42	34	29	53	41	34	29	40	33	29	39	33	28	38	32	28	27	27	27	27	27	27	27	27	27	27	27	

Zonal Lumen Summary

Zone	Lumens	% Lamp	% Fixture	Zone	Lumens	% Lamp	% Fixture
0-30	3841	N.A.	29.1	90-130	2	N.A.	0.0
0-40	6798	N.A.	51.5	90-150	6	N.A.	0.0
0-60	12029	N.A.	91.1	90-180	7	N.A.	0.1
0-90	13177	N.A.	99.8	0-180	13199	N.A.	100
90-120	1	N.A.	0.0				

Areamaster™ LED High Bay Luminaires

For Hazardous Locations. 250 W, 400 W, 750 W HID Light Level Equivalent

NEC/CEC:
 Class I, Division 2, Groups A, B, C, D
 Class I, Zone 2 Group IIC
 Class II, Division 1, Groups E, F, G

NEC/CEC:
 Class II Division 2, Groups F, G
 Class III
 Simultaneous Exposure
 Type 3R, 4, 4X
 IP66/67

NEC:
 Marine Outside Type
 (Salt Water)
 Wet Locations

ATEX/IECEX:
 Zones 2 and 22
 II 3 GD
 EPL Gc and Dc
 Ex nA IIC; Ex tc IIIC
 IP66, IK08

ATEX/IECEX:
 Zone 21
 II 2 D
 EPL Db
 Ex tb IIIC
 IK08

Photometric Data – DATA SHOWN IS ABSOLUTE

REPORT NUMBER: **AMLED87YBU1_FLOOD**

Lamps: Areamaster, Pendant Mount, LED Board 20 LEDs, Specular Reflector 6–1/2 X 6–1/2 Tapered To 3–1/2 X 3–1/2, Lens Clear

Characteristics: NEMA Type: 7Hx7V; Maximum Candela: 8092; Maximum Candela Angle: 25.5H 25.5V; Horizontal Beam Angle (50%): 97.3; Vertical Beam Angle (50%): 103; Horizontal Field Angle (10%): 137; Vertical Field Angle (10%): 136; Beam Lumens 14933; Field Lumens 18585; Luminaire Lumens 18842

AXIAL CANDELA

DEG.	HOR.	VERT.
90	0	0
85	31	5
75	36	8
65	1239	938
55	3463	3477
47.5	4393	4345
42.5	4921	4831
37.5	5955	5752
33	6455	6392
29	6656	6778
25.5	6998	7087
22.5	7109	7158
19.5	6665	6664
17	6302	6222
15	6059	6108
13	6027	6044
11	5931	5942
9	5914	5938
7	5933	5956
5	5974	5975
3	6003	5995
1	6002	6004
0	5999	5999

AXIAL CANDELA DISPLAY

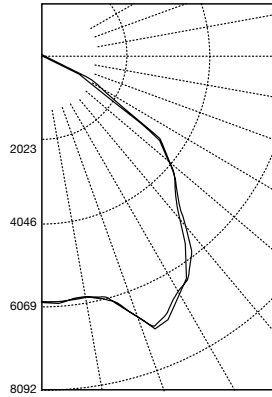

ISOCANDELA CURVES

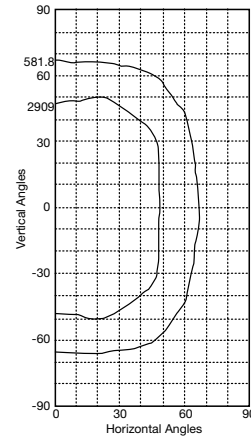

CIE Type – Direct

Plane	Spacing Criteria
0-180	1.54
90-270	1.54

REPORT NUMBER: **AMLED87YBU1_HIGHBAY**

Lamps: Areamaster, High Bay Mount, LED Board 20 LEDs, Specular Reflector 6–1/2 X 6–1/2 Tapered To 3–1/2 X 3–1/2, Lens Clear

Coefficients of Utilization – Zonal Cavity Method Effective Floor Cavity Reflectance 0.20

% Ceiling Rcc	% Walls Rw	Effective Floor Cavity Reflectance 0.20																					
		80				70				50				30				10				0	
0	119	119	119	119	116	116	116	116	111	111	111	111	106	106	106	102	102	102	100				
1	111	107	103	100	108	105	101	99	100	98	95	97	95	93	93	91	90	88	88				
2	102	95	89	84	99	93	88	83	89	85	81	86	83	79	83	80	77	75	75				
3	93	84	77	71	91	82	76	70	80	74	69	77	72	68	74	70	67	65	65				
4	86	75	67	60	84	73	66	60	71	64	59	69	63	58	67	62	58	56	56				
5	79	67	58	52	77	66	58	52	64	57	51	62	56	51	60	55	50	48	48				
6	73	60	52	45	71	59	51	45	57	50	45	56	49	45	54	49	44	42	42				
7	67	54	46	40	66	54	46	40	52	45	40	51	44	39	49	43	39	37	37				
8	63	49	41	36	61	49	41	35	47	40	35	46	40	35	45	39	35	33	33				
9	58	45	37	32	57	45	37	32	43	36	31	42	36	31	41	35	31	29	29				
10	54	42	34	29	53	41	34	29	40	33	28	39	33	28	38	32	28	26	26				

Zonal Lumen Summary

Zone	Lumens	% Lamp	% Fixture	Zone	Lumens	% Lamp	% Fixture
0-30	5462	N.A.	28.8	90-130	3	N.A.	0
0-40	9692	N.A.	51.2	90-150	5	N.A.	0
0-60	17247	N.A.	91.1	90-180	7	N.A.	0
0-90	18946	N.A.	100.1	0-180	18933	N.A.	100
90-120	2	N.A.	0				

Appleton

LED/FLOODLIGHTS: NEC/CEC, ATEX/IECEX ENCLOSED AND GASKETED

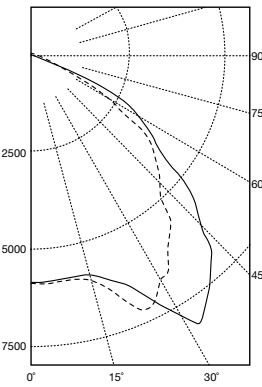

Industrial Areamaster™ LED Flood/High Bay Luminaires

For Ordinary Locations. 250 W, 400 W, 750 W HID Light Level Equivalent

NEC/CEC:
Type 3R, 4X
IP66, IP67
Suitable for use in Wet Locations
Marine Outside Type (Salt Water)

Applications

- Powerful, efficient weatherproof lighting for applications such as:
 - Security lighting
 - Production facilities
 - Warehouses
 - Processing plants
 - Storage areas
 - Parking garages and lots

Features

- Compact in size, attractively styled contemporary design, rugged and dependable.
- Easy to install and service.
- One-piece housing.
- One-piece lens in hinged cover. Secured by four M6 captive stainless steel slotted hex-head bolts.
- Thermal shock- and impact-resistant glass lens standard.
- Diffused polycarbonate lens available as an option.
- Heavy duty, high temperature silicone rubber gasket, mechanically secured.
- Universal design for flood and high bay mounting.
- Floodlight Mounting:
 - Yoke mount, zinc plated steel yoke with architectural bronze polyester finish.
- High Bay Mounting:
 - (1) Conduit entry on back of luminaire with locking set screw.
 - Rotate yoke up or remove.
- Chain Mounting:
 - Mounts via eyebolts threaded into the corners of the fixture.
 - Available with chain mounting, or as an accessory.
 - Rotate yoke up or remove.
- Cool operating temperatures translate into long luminaire life.
- Available with a total of three (3) 3/4" NPT entries with integral bushings.
- Two (2) 3/4" NPT aluminum close up plugs provided.
- Electrical:
 - NEC/CEC: 120-277 Vac, 50/60 Hz; 347-480 Vac, 50/60 Hz.; 250 Vdc available on AMLED77YBC.
- Terminal block (screw type for secure connection) can accept UL/CSA 24-10AWG and IEC 0.2 - 4 mm².

Standard Materials

- Housing and lens door: copperfree (4/10 of 1% max.) aluminum
- Gasket: silicone rubber
- Reflector: metallized high reflectance finish
- Yoke mount: zinc plated steel
- Bolts: stainless steel
- Close up plugs: (2) aluminum provided

Standard Finishes

- Housing, lens cover and yoke mount: architectural bronze polyester



Floodlight



High Bay

NEC/CEC Certifications and Compliances

- UL Standard: UL 1598, UL 1598A,
- CSA Standards: C22.2 No. 250.0
- cCSAus Certified: 164460

DesignLights™ Consortium (for the following models)

- IAMLED67YBU1
- IAMLED67YBU1D
- IAMLED77YBU1
- IAMLED77YBU1D
- IAMLED87YBU1
- IAMLED87YBU1D

LED/FLOODLIGHTS: NEC/CEC ORDINARY LOCATION

Appleton

Industrial Areamaster™ LED Flood/High Bay Luminaires

For Ordinary Locations. 250 W, 400 W, 750 W HID Light Level Equivalent

NEC/CEC:
Type 3R, 4X
IP66, IP67
Suitable for use in Wet Locations
Marine Outside Type (Salt Water)

Order using catalog numbering guide below or select catalog number from tables on following pages.

Catalog Numbering Guide – Industrial Areamaster LED

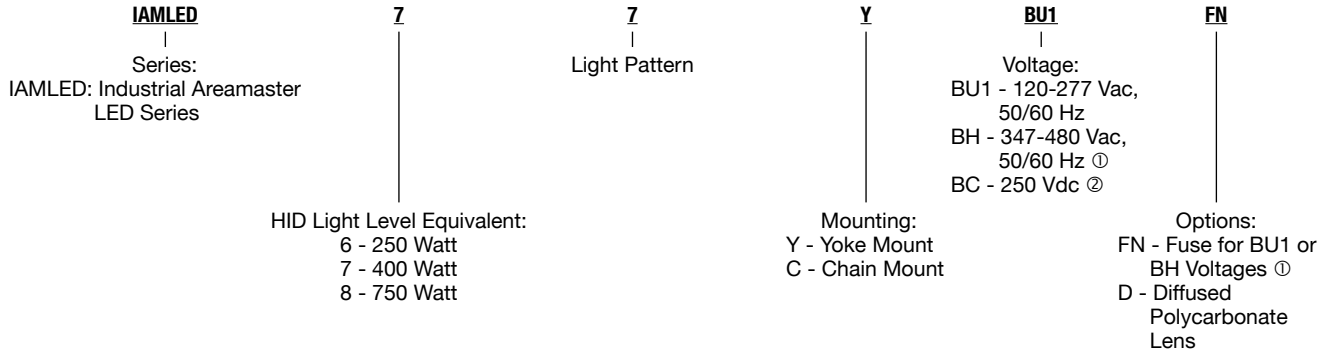

Electrical Specifications – Flood Mount

Catalog Number	Voltage Range	Frequency (Hz)	Watts Input Power (Nom.)	Input Amps (Max.)	Total Harmonic Distortion	Power Factor
IAMLED67YBU1	120-277 Vac	50/60	86/85	0.72 - 0.32	0.5	> 0.98
IAMLED67YBH	347-480 Vac	50/60	88/90	0.25 - 0.19	0.5	> 0.96
IAMLED77YBU1	120-277 Vac	50/60	125/121	1.10 - .047	0.5	> 0.98
IAMLED77YBH	347-480 Vac	50/60	124/125	0.35 - 0.25	0.5	> 0.96
IAMLED77YBC	250 Vdc	—	118	0.47	0.5	> 0.98
IAMLED87YBU1	120-277 Vac	50/60	176/175	1.60 - 0.70	0.5	> 0.98

Line Voltage	Catalog Number
120-277 Vac, 50/60 Hz	IAMLED67YBU1
120-277 Vac, 50/60 Hz	IAMLED77YBU1
120-277 Vac, 50/60 Hz	IAMLED87YBU1
347-480 Vac, 50/60 Hz	IAMLED67YBH
347-480 Vac, 50/60 Hz	IAMLED77YBH
250 Vdc	IAMLED77YBC



① Not available for use on the 750 Watt equivalent.
② Not available for use on the 250 and 750 Watt equivalent.





LED/FLOODLIGHTS: NEC/CEC ORDINARY LOCATION

Appleton®

Industrial Areamaster™ LED Flood/High Bay Luminaires

For Ordinary Locations. 250 W, 400 W, 750 W HID Light Level Equivalent

NEC/CEC:
 Type 3R, 4X
 IP66, IP67
 Suitable for use in Wet Locations
 Marine Outside Type (Salt Water)

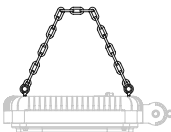
Accessories and Replacement Parts		
	Description	Catalog Number
Crossarm Mounting Bracket		
	Has 180° horizontal adjustment — degree marked. Facilitates mounting floodlight to crossarm or other flat surface, or to G-AM-8-WB. Includes floodlight yoke bolts. Malleable iron, zinc plated, chromate sealed, architectural bronze polyester finish.	G-AM-8-CA
Pipe or Wall Mount Bracket		
	Used with G-AM-8-CA. Clamps to 1" to 2-1/2" pipe, vertical or horizontal, or mounts on flat surfaces. Includes U-bolt and crossarm bracket bolts. Malleable iron, zinc plated, chromate sealed, with architectural bronze polyester finish.	G-AM-8-WB
Poletop Slip-Fitter		
	Slip-fits 1-1/2" or 2" pipe size poletop tenons. Includes floodlight yoke bolts, 3 locking bolts, and cord grip. Body is malleable iron-zinc plated, chromate sealed, with cast aluminum cap. Assembly has architectural bronze polyester finish.	G-SF20
	Slip-fits 1" or 1-1/2" pipe size poletop tenons. Includes floodlight yoke bolts, 3 locking bolts, and cord grip. Body is malleable iron-zinc plated, chromate sealed, with cast aluminum cap. Assembly has architectural bronze polyester finish.	AMLEDSF1
Poletop Slip-Fitter		
	Slip-fits 2" or 2-1/2" poletop tenons. Includes floodlight yoke bolts, 3 locking bolts, and cord grip. Malleable iron, zinc plated, chromate sealed, with architectural bronze polyester finish.	G-AM-8-SF
Chain		
	Chain mount assembly comes with two (2) 914.4 mm (36 inch) long chains, four (4) eye bolts, four (4) hex bolts, four (4) lock washers, four (4) hex nuts, eight (8) plain washers and an instruction sheet for complete assembly and mounting. Chains are galvanized steel, eye bolts are zinc plated steel, all other hardware is stainless steel.	AMLEDCM
LED Array		
	LED Array with White LED's for the IAMLED67	IAMLED67AW
	LED Array with White LED's for the IAMLED77	IAMLED77AW
	LED Array with White LED's for the IAMLED87	IAMLED87AW
Drivers		
	120 - 277 Vac Driver — BU1 Version — IAMLED87: Left Side — IAMLED67, IAMLED77	IAMLEDDBU1L
	120 - 277 Vac Driver — BU1 Version — IAMLED87: Right Side	IAMLEDDBU1R
	347 - 480 Vac Driver — BH Version	IAMLED77DBH
	250 Vdc Driver — BC Version	IAMLED77DBU
Door Assembly		
	Door Assembly with a Glass Lens, Pins	IAMLEDMDOOR
	Door Assembly with a Polycarbonate Lens, Pins	IAMLEDMDOORP

LED/FLOODLIGHTS: NEC/CEC ORDINARY LOCATION



Industrial Areamaster™ LED Flood/High Bay Luminaires

For Ordinary Locations. 250 W, 400 W, 750 W HID Light Level Equivalent

NEC/CEC:
 Type 3R, 4X
 IP66, IP67
 Suitable for use in Wet Locations
 Marine Outside Type (Salt Water)

Dimensions in Millimeters (Inches)

Floodlight

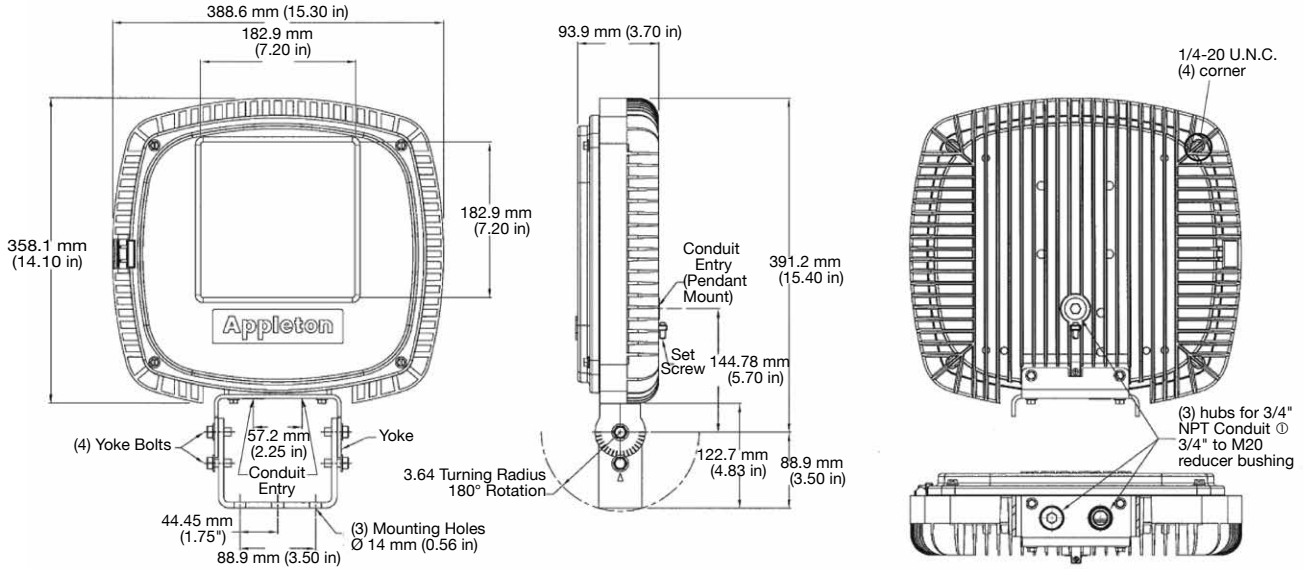

High Bay Pendant Mount

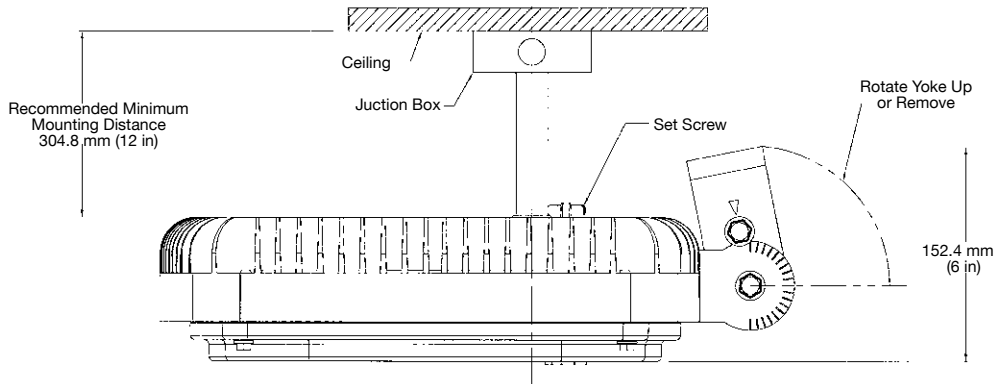

LED/FLOODLIGHTS: NEC/CEC ORDINARY LOCATION

Appleton

Industrial Areamaster™ LED Flood/High Bay Luminaires

For Ordinary Locations. 250 W, 400 W, 750 W HID Light Level Equivalent

NEC/CEC:
 Type 3R, 4X
 IP66, IP67
 Suitable for use in Wet Locations
 Marine Outside Type (Salt Water)

Photometric Data – DATA SHOWN IS ABSOLUTE

REPORT NUMBER: **IAMLED67YBU1_FLOOD**

Lamps: Areamaster, High Bay Mount, LED Board 39 LEDs, Specular Reflector 6–1/2 X 6–1/2 Tapered To 3–1/2 X 3–1/2, Lens Clear

Luminaire Lumens 8238

POLAR CANDELA DISTRIBUTION

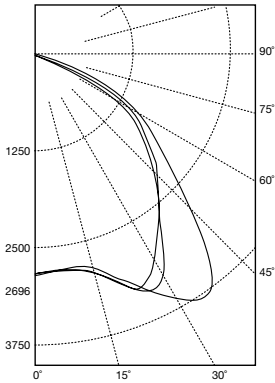

ISOCANDELA CURVES

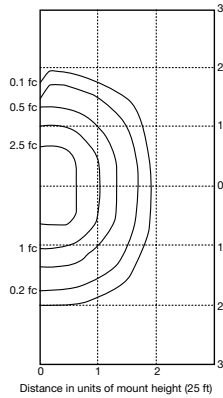

Zonal Lumen and Percentage at 25 °C (77 °F)

Zone	Lumens	% Lamp	% Fixture
0-10	245.6	N.A.	3.0
10-20	771.8	N.A.	9.4
20-30	1431	N.A.	17.4
30-40	1842	N.A.	22.4
40-50	1785	N.A.	21.7
50-60	1448	N.A.	17.6
60-70	667.1	N.A.	8.1
70-80	43.8	N.A.	0.5
80-90	4.5	N.A.	0.1

REPORT NUMBER: **IAMLED67YBU1_Highbay**

Lamps: Areamaster, High Bay Mount, LED Board 39 LEDs, Specular Reflector 6–1/2 X 6–1/2 Tapered To 3–1/2 X 3–1/2, Lens Clear

POLAR CANDELA DISTRIBUTION

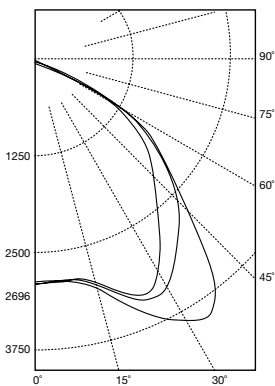

Zonal Lumen Summary and Percentage at 25 °C (77 °F)

Zone	Lumens	% Lamp	% Fixture
0-30	2434	N.A.	29.2
0-40	4283	N.A.	51.6
0-60	7553	N.A.	90.6
60-90	780	N.A.	9.4
0-90	8333	N.A.	100.0
90-180	0	N.A.	0
0-180	8333	N.A.	100.0

Zonal Lumen and Percentage at 25 °C (77 °F)

Zone	Lumens	% Lamp	% Fixture
0-10	244.8	N.A.	2.9
10-20	764.2	N.A.	9.2
20-30	1425	N.A.	17.1
30-40	1849	N.A.	22.2
40-50	1787	N.A.	21.4
50-60	1483	N.A.	17.8
60-70	731.0	N.A.	8.8
70-80	46.7	N.A.	0.6
80-90	2.4	N.A.	0.0

LED/FLOODLIGHTS: NEC/CEC ORDINARY LOCATION

Appleton

Industrial Areamaster™ LED Flood/High Bay Luminaires

For Ordinary Locations. 250 W, 400 W, 750 W HID Light Level Equivalent

NEC/CEC:
 Type 3R, 4X
 IP66, IP67
 Suitable for use in Wet Locations
 Marine Outside Type (Salt Water)

Photometric Data – DATA SHOWN IS ABSOLUTE

REPORT NUMBER: **IAMLED77YBU1_FLOOD**

Lamps: Areamaster, High Bay Mount, LED Board 56 LEDs, Specular Reflector 6–1/2 X 6–1/2 Tapered To 3–1/2 X 3–1/2, Lens Clear

Characteristics: Maximum Candela: 5818; Maximum Candela Angle: 22.5 H 25.5 V; Horizontal Beam Angle (50%): 97.0; Vertical Beam Angle (50%): 102; Horizontal Field Angle (10%): 134; Vertical Field Angle (10%): 134; Beam Lumens 10414; Field Lumens 12967; Luminaire Lumens 13157

LED/FLOODLIGHTS: NEC/CEC ORDINARY LOCATION

AXIAL CANDELA

DEG.	HOR.	VERT.
90.0	0	0
85.0	21	2
75.0	26	5
65.0	700	733
55.0	2400	2341
47.5	3023	2976
42.5	3375	3307
37.5	3838	3826
33.0	4312	4319
29.0	4670	4719
25.5	4964	4898
22.5	4910	4857
19.5	4700	4660
17.0	4456	4343
15.0	4273	4249
13.0	4184	4165
11.0	4154	4123
9.0	4139	4105
7.0	4124	4119
5.0	4127	4133
3.0	4138	4150
1.0	4149	4153
0.0	4149	4149

AXIAL CANDELA DISPLAY

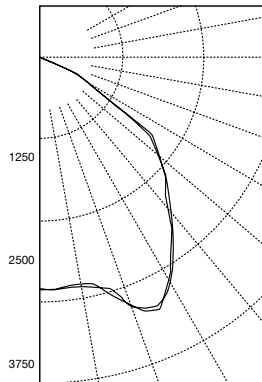

ISOCANDELA CURVES

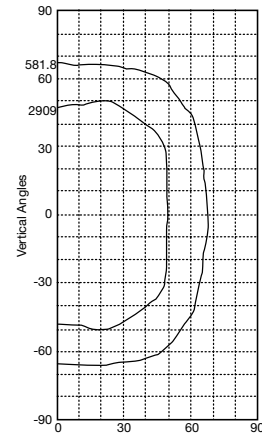

CIE Type – Direct

Plane	Spacing Criteria
0 Deg	1.5
90 Deg	1.5

Zone	Lumens
0-5	98
5-10	290
10-15	485
15-20	711
20-25	993
25-30	1264
30-35	1440
35-40	1517
40-45	1471
45-50	1392
50-55	1283
55-60	1086
60-65	764
65-70	340
70-75	37
75-80	4
80-85	2
85-90	1

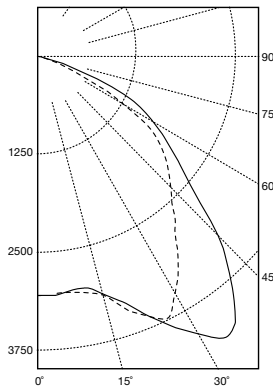

REPORT NUMBER: **IAMLED77YBU1_HIGHBAY**

Lamps: Areamaster, High Bay Mount, LED Board 56 LEDs, Specular Reflector 6–1/2 X 6–1/2 Tapered To 3–1/2 X 3–1/2, Lens Clear

Coefficients of Utilization – Zonal Cavity Method

Effective Floor Cavity Reflectance 0.20

% Ceiling Rcc	80	70				50				30				10				0	
		70	50	30	10	70	50	30	10	50	30	10	50	30	10	0			
0	119	119	119	119	116	116	116	116	111	111	111	111	106	106	106	102	102	102	100
1	111	107	103	100	108	105	102	99	101	98	96	97	95	93	93	92	90	88	
2	102	95	89	84	99	93	88	83	90	85	81	86	83	79	83	80	78	76	
3	94	84	77	71	91	83	76	70	80	74	69	77	72	68	75	70	67	65	
4	86	75	67	61	84	74	66	60	71	65	59	69	63	59	67	62	58	56	
5	79	67	59	52	77	66	58	52	64	57	52	62	56	51	60	55	50	48	
6	73	60	52	46	71	59	51	45	58	50	45	56	50	45	54	49	44	42	
7	67	54	46	40	66	54	46	40	52	45	40	51	44	39	49	44	39	37	
8	63	50	41	36	61	49	41	36	48	40	35	46	40	35	45	39	35	33	
9	58	45	37	32	57	45	37	32	44	37	32	43	36	31	42	36	31	30	
10	55	42	34	29	53	41	34	29	40	33	29	39	33	28	38	32	28	27	

Zonal Lumen Summary

Zone	Lumens	% Lamp	% Fixture	Zone	Lumens	% Lamp	% Fixture
0-30	3841	N.A.	29.1	90-130	2	N.A.	0.0
0-40	6798	N.A.	51.5	90-150	6	N.A.	0.0
0-60	12029	N.A.	91.1	90-180	7	N.A.	0.1
0-90	13177	N.A.	99.8	0-180	13199	N.A.	100
90-120	1	N.A.	0.0				

Industrial Areamaster™ LED Flood/High Bay Luminaires

For Ordinary Locations. 250 W, 400 W, 750 W HID Light Level Equivalent

NEC/CEC:
 Type 3R, 4X
 IP66, IP67
 Suitable for use in Wet Locations
 Marine Outside Type (Salt Water)

Photometric Data – DATA SHOWN IS ABSOLUTE

REPORT NUMBER: **IAMLED87YBU1_FLOOD**

Lamps: Areamaster, Pendant Mount, LED Board 20 LEDs, Specular Reflector 6–1/2 X 6–1/2 Tapered To 3–1/2 X 3–1/2, Lens Clear

Characteristics: NEMA Type: 7Hx7V; Maximum Candela: 8092; Maximum Candela Angle: 25.5H 25.5V; Horizontal Beam Angle (50%): 97.3; Vertical Beam Angle (50%): 103; Horizontal Field Angle (10%): 137; Vertical Field Angle (10%): 136; Beam Lumens 14933; Field Lumens 18585; Luminaire Lumens 18842

AXIAL CANDELA			
DEG.	HOR.	VERT.	
90	0	0	0
85	31	5	5
75	36	8	8
65	1239	938	938
55	3463	3477	3477
47.5	4393	4345	4345
42.5	4921	4831	4831
37.5	5955	5752	5752
33	6455	6392	6392
29	6656	6778	6778
25.5	6998	7087	7087
22.5	7109	7158	7158
19.5	6665	6664	6664
17	6302	6222	6222
15	6059	6108	6108
13	6027	6044	6044
11	5931	5942	5942
9	5914	5938	5938
7	5933	5956	5956
5	5974	5975	5975
3	6003	5995	5995
1	6002	6004	6004
0	5999	5999	5999

AXIAL CANDELA DISPLAY

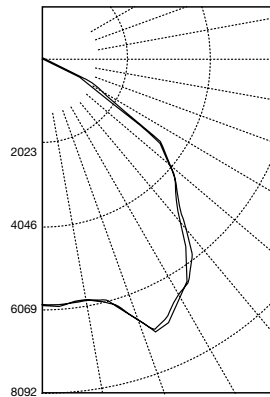

ISOCANDELA CURVES

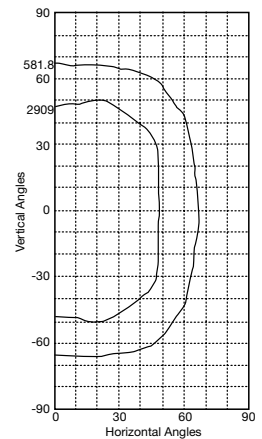

CIE Type – Direct

Plane	Spacing Criteria
0-180	1.54
90-270	1.54

Zone	Lumens
0- 5	141
5- 10	419
10- 15	697
15- 20	1004
20- 25	1408
25- 30	1794
30- 35	2079
35- 40	2151
40- 45	2143
45- 50	2011
50- 55	1834
55- 60	1567
60- 65	1118
65- 70	514
70- 75	62
75- 80	3
80- 85	2
85- 90	1

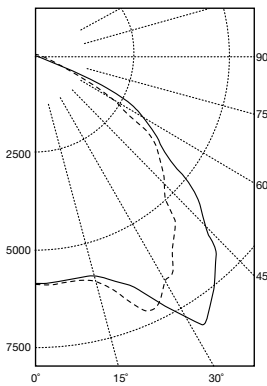

REPORT NUMBER: **IAMLED87YBU1_Highbay**

Lamps: Areamaster, High Bay Mount, LED Board 20 LEDs, Specular Reflector 6–1/2 X 6–1/2 Tapered To 3–1/2 X 3–1/2, Lens Clear

Coefficients of Utilization – Zonal Cavity Method

Effective Floor Cavity Reflectance 0.20

% Ceiling Rcc	% Walls Rw	Effective Floor Cavity Reflectance 0.20																					
		80				70				50				30				10				0	
0	119	119	119	119	116	116	116	116	111	111	111	111	106	106	106	102	102	102	100				
1	111	107	103	100	108	105	101	99	100	98	95	97	95	93	93	91	90	88					
2	102	95	89	84	99	93	88	83	89	85	81	86	83	79	83	80	77	75					
3	93	84	77	71	91	82	76	70	80	74	69	77	72	68	74	70	67	65					
4	86	75	67	60	84	73	66	60	71	64	59	69	63	58	67	62	58	56					
5	79	67	58	52	77	66	58	52	64	57	51	62	56	51	60	55	50	48					
6	73	60	52	45	71	59	51	45	57	50	45	56	49	45	54	49	44	42					
7	67	54	46	40	66	54	46	40	52	45	40	51	44	39	49	43	39	37					
8	63	49	41	36	61	49	41	35	47	40	35	46	40	35	45	39	35	33					
9	58	45	37	32	57	45	37	32	43	36	31	42	36	31	41	35	31	29					
10	54	42	34	29	53	41	34	29	40	33	28	39	33	28	38	32	28	26					

Zonal Lumen Summary

Zone	Lumens	% Lamp	% Fixture	Zone	Lumens	% Lamp	% Fixture
0-30	5462	N.A.	28.8	90-130	3	N.A.	0
0-40	9692	N.A.	51.2	90-150	5	N.A.	0
0-60	17247	N.A.	91.1	90-180	7	N.A.	0
0-90	18946	N.A.	100.1	0-180	18933	N.A.	100
90-120	2	N.A.	0				

Areamaster™ Green LED Flood/High Bay Luminaires

General Duty

NEC/CEC:
Rated for Ordinary (Classified) Locations

Applications

- Locations where a green light is required for steel manufacturing quality inspection

Features

- LED color: green.
- Compact in size, attractively styled contemporary design, rugged and dependable.
- Easy to install and service.
- One-piece housing.
- One-piece lens cover. Secured by four M6 captive stainless steel slotted hex-head bolts.
- Thermal shock and impact resistant glass lens.
- Heavy duty, high temperature silicone rubber gasket, firmly seated.
- Floodlight Mounting:
 - Yoke mount, zinc plated steel yoke with architectural bronze polyester finish.
- High Bay Mounting:
 - (1) Conduit entry on back of luminaire.
 - Rotate yoke up or remove.
- Vibration rated in all configurations.
- Cool operating temperatures translate into long luminaire life.
- Total of three (3) 3/4" NPT entries with integral bushings.
- Two (2) aluminum close up plugs provided.
- Electrical: 120-277 Vac, 50/60 Hz.
- Nominal input power: 165.
- Maximum input Amps: 1.40 - 0.60.
- Power factor: > 0.90.
- Terminal block (screw type for secure connection) can accept 24-10 AWG wire.

Standard Materials

- Ballast housing and lens door: copperfree (4/10 of 1% max.) aluminum
- Gasket: silicone rubber
- Reflector: metallized high reflectance finish
- Yoke mount: zinc plated steel
- Bolts: stainless steel
- Plugs: (2) aluminum provided

Standard Finishes

- Housing, lens cover and yoke mount: architectural bronze polyester



Floodlight



High Bay

LED/FLOODLIGHTS: NEC/CEC ORDINARY LOCATION

Appleton





Areamaster™ Green LED Flood/High Bay Luminaires

General Duty

NEC/CEC:
Rated for Ordinary (Classified) Locations

	Line Voltage	Yoke Mount Catalog Number
	120-277 50/60 Hz	AMLED774BU1GR

Accessories

	Description	Catalog Numbers
Crossarm Mounting Bracket		
	Has 180° horizontal adjustment — degree marked. Facilitates mounting floodlight to crossarm or other flat surface, or to G-AM-8-WB. Includes floodlight yoke bolts. Malleable iron, zinc plated, chromate sealed, architectural bronze polyester finish.	G-AM-8-CA
Pipe or Wall Mount Bracket		
	Used with G-AM-8-CA. Clamps to 1" to 2-1/2" pipe, vertical or horizontal, or mounts on flat surfaces. Includes U-bolt and crossarm bracket bolts. Malleable iron, zinc plated, chromate sealed, with architectural bronze polyester finish.	G-AM-8-WB
Poletop Slip-Fitter		
	Slip-fits 1-1/2" or 2" pipe size poletop tenons. Includes floodlight yoke bolts, 3 locking bolts, and cord grip. Body is malleable iron-zinc plated, chromate sealed, with cast aluminum cap. Assembly has architectural bronze polyester finish.	G-SF20
Poletop Slip-Fitter		
	Slip-fits 2" or 2-1/2" poletop tenons. Includes floodlight yoke bolts, 3 locking bolts, and cord grip. Malleable iron, zinc plated, chromate sealed, with architectural bronze polyester finish.	G-AM-8-SF

LED/FLOODLIGHTS: NEC/CEC ORDINARY LOCATION

Appleton®

Areamaster™ Green LED Flood/High Bay Luminaires

General Duty

NEC/CEC:
 Rated for Ordinary (Classified) Locations

Dimensions in Millimeters (Inches)

Floodlight

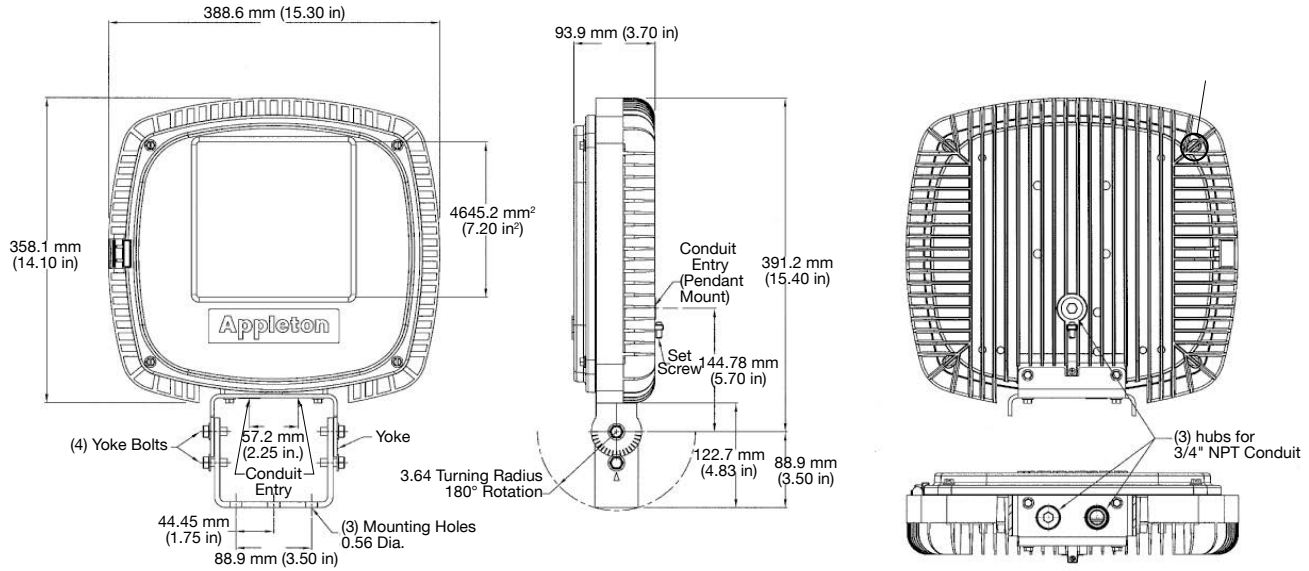

High Bay Pendant Mount

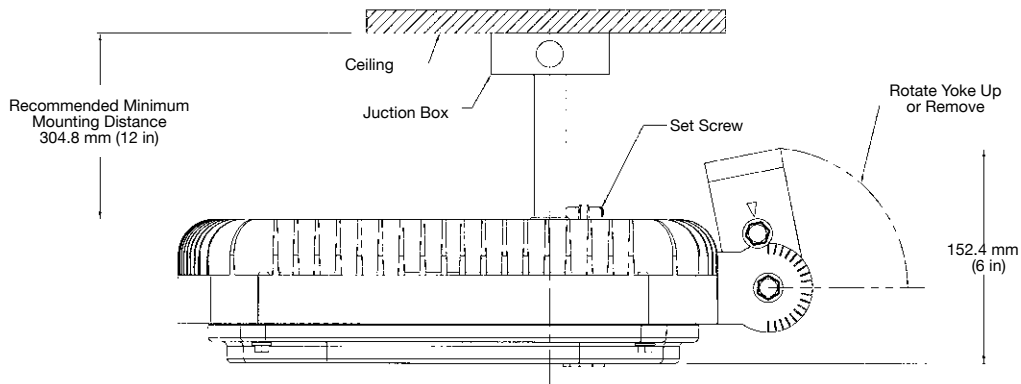

LED/FLOODLIGHTS: NEC/CEC ORDINARY LOCATION

Appleton

Areamaster™ Green LED Flood/High Bay Luminaires

General Duty

NEC/CEC:
Rated for Ordinary (Classified) Locations

Photometric Data — DATA SHOWN IS ABSOLUTE

REPORT NUMBER: **AMLED77YBUGR**

Fixture: Flood Mount, Led Board 60 LED, Specular Reflector 6–1/2 X 6–1/2 Tapered To 3–1/2 X 3–1/2 , Lens Clear 7 x 7"

Floodlight Characteristics

IES Type	7H X 7V
Maximum Candlepower	3424. AT 22.5 H, 25.5 V
Horizontal Beam Angle (50%)	101.5 deg
Vertical Beam Angle (50%)	100.3 deg
Horizontal Field Angle (10%)	134.6 deg
Vertical Field Angle (10%)	134.2 deg
Beam Lumens (Efficiency)	6436. (79.7)
Field Lumens (Efficiency)	7949. (98.4)
Total Lumens (Efficiency)	8075. (100.0)

Axial Candlepower

Deg	Horizontal	Deg	Vertical
90.0	0.	90.0	0.
85.0	20.	85.0	1.
75.0	22.	75.0	3.
65.0	438.	65.0	444.
55.0	1479.	55.0	1460.
47.5	1889.	47.5	1828.
42.5	2146.	42.5	2121.
37.5	2539.	37.5	2515.
33.0	2807.	33.0	2928.
29.0	3043.	29.0	3121.
25.5	3163.	25.5	3186.
22.5	3063.	22.5	3080.
19.5	2968.	19.5	2936.
17.0	2807.	17.0	2758.
15.0	2795.	15.0	2731.
13.0	2771.	13.0	2706.
11.0	2732.	11.0	2704.
9.0	2714.	9.0	2711.
7.0	2721.	7.0	2722.
5.0	2728.	5.0	2731.
3.0	2736.	3.0	2730.
1.0	2729.	1.0	2731.
0.0	2730.	0.0	2730.

Plot(s) is/are single sweep(s) — Stray light is NOT accounted for. Lateral trace thru 90 deg Vertical.

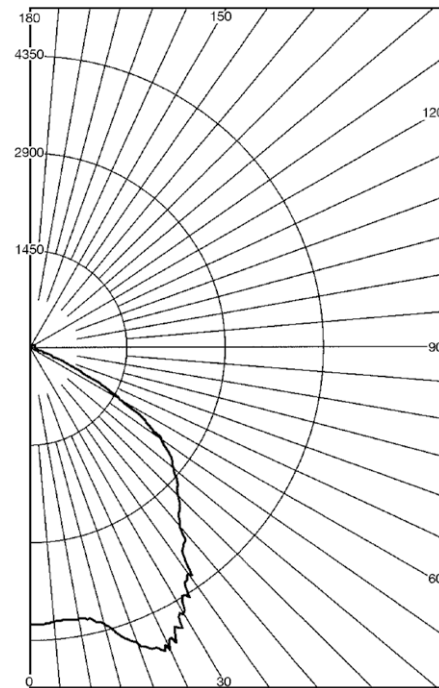

LED/FLOODLIGHTS: NEC/CEC ORDINARY LOCATION

Appleton

ATX™ FDBAES LED Series Self-Contained Emergency Lighting Units

Flameproof

ATEX/IECEX:

Zone 1 and 2 - 21 and 22

Ⓜ II 2 GD

IP66/68 - IK08

Applications

- Provides adequate lighting and/or visual indication of access on exit routes during an evacuation in a hazardous environment.
- Can be installed in hazardous areas designated as Zone 1 and 2 - 21 and 22.
- Typical applications include oil refineries, petrochemical plants, pulp and paper mills.

Features

All versions:

- Power supply 230 Vac, 50/60 Hz.
- 1 hour duration (emergency).
- Threaded access cover with O-ring seal.
- Can be maintained in hazardous areas as an internal switch cuts off battery supply automatically once the cover is unscrewed and opened.
- Battery pack.
- Escape route lighting: 2.4 V - 1.5 Ah (2 cells - Nicd)
Space lighting: 7.2 V - 2.2 Ah (6 cells - NiMh) - Flameproof
- Padlockable switch is available on switched models which individually cuts off power supply and remote control.
- Charge indicator by 1 green LED (life time over 10 years).
- Operates in any position.
- Connection to plug-in terminal block via 2 x 5 x 2.5 mm² (0.003 x 0.008 x 0.004 in²) terminals.
- Supplied with two fixing lugs.
- Automatic built-in self-test system (SATI) with memorization of tests indicated by LEDs.
- Using a microprocessor and an internal clock, the unit will carry out automatic tests.
- Weekly test: Lamp check during 6 seconds.
- Quarterly test: Emergency operation and lamp check for 1 hour.
- Can be remotely controlled and checked without switching the mains off with remote control unit from Legrand (Catalog Number 03901) or URA (Catalog Number 095448 and 095450) manufacturers.
- The remote control unit installed in a safe area or inside a flameproof box allows manual ignition of all the units (maximum 300 units) for visual inspection of their operation.
- Escape route lighting: 55 lumens, 0.50 wattage.
Space lighting: 540 lumens, 0.95 wattage.

Addressable versions:

- Operates without additional control lines. Communication between units and the control system is realized via mains borne signals that utilize the existing electrical wiring.
- Standard control system capacity: one control system for up to 200 emergency lighting units.
- Optional increased control system capacity: booster (repeater unit) is used to increase the length of the network allowing up to 1000 emergency lighting units to be on one control system. This allows for the use of a single computer to centralize the management of the facilities emergency lighting system. For more information, please contact your local sales representative.

Standard Materials

- End caps and cover: aluminum
- O-ring seal: Nitrile
- Lens: tempered borosilicate glass
- Fixing brackets: zinc plated steel or 316 stainless steel
- Accessories: white painted galvanized steel
- Guard: zinc plated steel



FDBAESLEDEM

Options

- Addressable monitoring software, please consult your local sales representative.
- Low temperature application, please consult your local sales representative.

ATEX/IECEX Certifications and Compliances

- Certification Type: FLd
 - Gas: Zone 1 - 2
 - Conforming to ATEX 94/9/CE: Ⓜ II 2 G
 - Type of Protection: Ex d IIC
 - Temperature class: T6
 - Dust: Zone 21 - 22
 - Conforming to ATEX 94/9/CE: Ⓜ II 2 D
 - Type of Protection: Ex tD A21
 - Surface Temperature: T80 °C (T176 °F)
- Ambient Temperature: -40 °C to +55 °C (-40 °F to +131 °F) ①
- CE Declaration of Conformity: 50203
- ATEX Certificate: LCIE 97/ ATEX 6012
- IECEX Certificate: IECEX LCI 04.0018
- Index of Protection according EN/IEC 60529: IP66/68
- Impact Resistance (shock): IK08
- Internal Volume: > 2 dm³ (122 in³) - 2 liters
- Conforming to NF AEAS

EURASEC Certification

- EURASEC N° TC RU C-FR.Г505.B.00912

Other Certification

- INMETRO Certificate: BVC 11.0492 ②

Related Products

- For labels see *Labels for Emergency Lighting Units, ATX Self-Adhesive Signaling Labels for Emergency Lighting Units.*

① Optimum operating temperature for battery is -5 °C to +30 °C (+23 °F to +86 °F)

② Inmetro certification available on special request only. Contact your local sales representative for more information.

ATX™ FDBAES LED Series Self-Contained Emergency Lighting Units

Flameproof

ATEX/IECEX:
 Zone 1 and 2 - 21 and 22
 II 2 GD
 IP66/68 - IK08

Catalog Numbering Guide

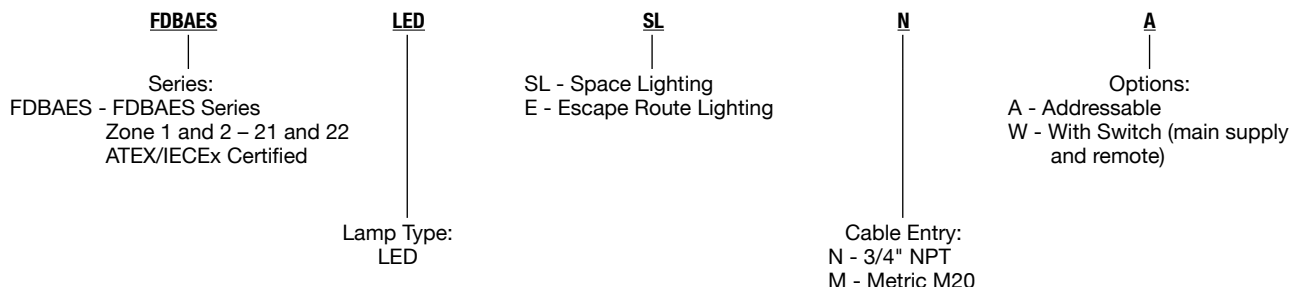

Type	Lamp	Lumen Output	Cable Entries	Weight kg (lb)	Volume dm ³ (in ³)	Catalog Number
Unswitched Version – 1 hour duration – Non-maintained – Two threaded cable entries with one blanking plug						
Space Lighting	LED Array	540 lm ①	3/4" NPT	8.1 (0.32)	37.1 (2264.0)	FDBAESLEDSL N
			M20			FDBAESLEDSL M
Escape Route Lighting	LED Array	55 lm ②	3/4" NPT	8.1 (0.32)	37.1 (2264.0)	FDBAESLEDE N
			M20			FDBAESLEDE M
Switched Version – 1 hour duration – Non-maintained – One threaded cable entry						
Space Lighting	LED Array	540 lm	3/4" NPT	10.0 (0.39)	40.4 (2465.4)	FDBAESLEDSL N W
			M20			FDBAESLEDSL M W
Escape Route Lighting	LED Array	55 lm	3/4" NPT	10.0 (0.39)	40.4 (2465.4)	FDBAESLEDE N W
			M20			FDBAESLEDE M W
Addressable and Unswitched Version – 1 hour duration – Non-maintained – Two threaded cable entries with one blanking plug						
Space Lighting	LED Array	540 lm	3/4" NPT	8.1 (0.32)	37.1 (2264.0)	FDBAESLEDSL N A
			M20			FDBAESLEDSL M A
Escape Route Lighting	LED Array	55 lm	3/4" NPT	8.1 (0.32)	37.1 (2264.0)	FDBAESLEDE N A
			M20			FDBAESLEDE M A
Addressable and Switched Version – 1 hour duration – Non-maintained – One threaded cable entry						
Space Lighting	LED Array	540 lm	M20	10.0 (0.39)	40.4 (2465.4)	FDBAESLEDSL M A W
Escape Route Lighting	LED Array	55 lm	M20	10.0 (0.39)	40.4 (2465.4)	FDBAESLEDE M A W

① Value measured after 1 hour duration - required value by standard is 400 lm.





② Value measured after 1 hour duration - required value by standard is 45 lm.

ATX™ FDBAES LED Series Self-Contained Emergency Lighting Units

Flameproof

ATEX/IECEX:
 Zone 1 and 2 - 21 and 22
 II 2 GD
 IP66/68 - IK08

Accessories

	Description	Catalog Number
	Reflector White painted galvanized steel	FDER5G
	Protective Guard Zinc plated steel	FDPG5Z
	Fixing Brackets – set of two brackets for ease of surface installation Zinc plated steel 316 stainless steel	FDFBZ FDFBS
	Surface Mounting Brackets – set of two brackets for ease of installation Zinc plated steel 316 stainless steel	FDSBZ FDSBS
	Half Clamps – set of two Zinc plated steel versions: Diameter for 1-1/4 to 1-1/2" pole: 42 mm (16.65 in) to 49 mm (1.93 in) Diameter for 2" pole: 60 mm (2.36 in) 316 stainless steel versions: Diameter for 1-1/4 to 1-1/2" pole: 42 mm (16.65 in) to 49 mm (1.93 in) Diameter for 2" pole: 60 mm (2.36 in)	FDHC49Z FDHC60Z FDHC49S
	Fall Prevention Kit 1.20 m (3.94 ft) stainless steel chain	FDHC60S FDSCS

LED/ATEX/IECEX BULKHEAD

Appleton®

ATX™ FDBAES LED Series Self-Contained Emergency Lighting Units Flameproof

ATEX/IECEX:
Zone 1 and 2 - 21 and 22
II 2 GD
IP66/68 - IK08

LED Indicator

Space Lighting — Replaces Fluorescent Version

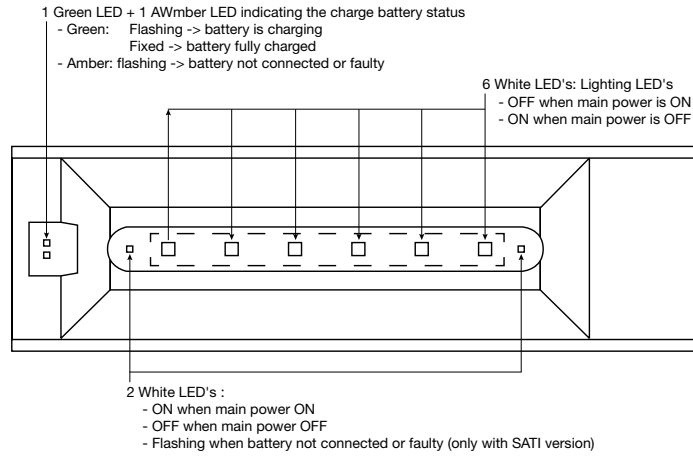

Escape Lighting — Replaces Incandescent Version

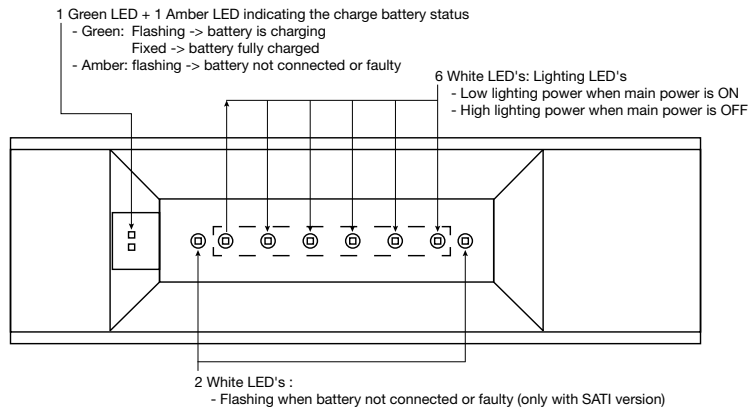

Main Status	Non Maintained	
	Space Lighting	Escape Route Lighting
Switched On	☀ ● ● ● ● ● ● ● ☀	● ☒ ☒ ☒ ☒ ☒ ☒ ●
Switched Off	● ☀ ☀ ☀ ☀ ☀ ☀ ●	● ☀ ☀ ☀ ☀ ☀ ☀ ●

● OFF
 ☀ ON (high lighting power)
 ☒ ON (low lighting power)

Battery not Connected or Faulty	Main Power ON	
	Space or Escape Route Lighting	
SATI	⚠	⚠ ● ● ● ● ● ● ● ⚠
Addressable	⚠	● ● ● ● ● ● ● ●

● OFF
 ⚠ ON — Flashing — White LED
 ⚠ ON — Flashing — Amber LED

LED/ATEX/IECEX BULKHEAD



ATX™ FDBAES LED Series Self-Contained Emergency Lighting Units

Flameproof

ATEX/IECEX:
 Zone 1 and 2 - 21 and 22
 II 2 GD
 IP66/68 - IK08

Electrical Wiring Diagram

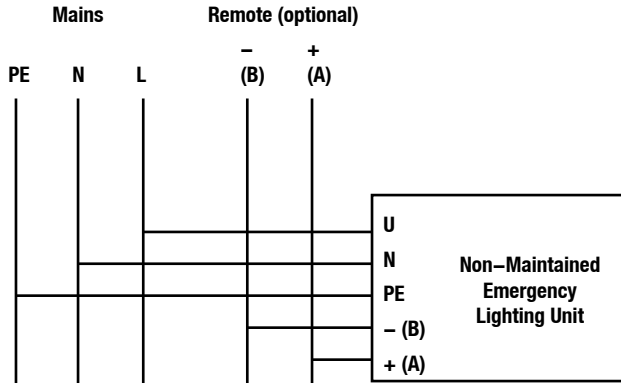

Dimensions in Millimeters (Inches)

Unswitched Versions

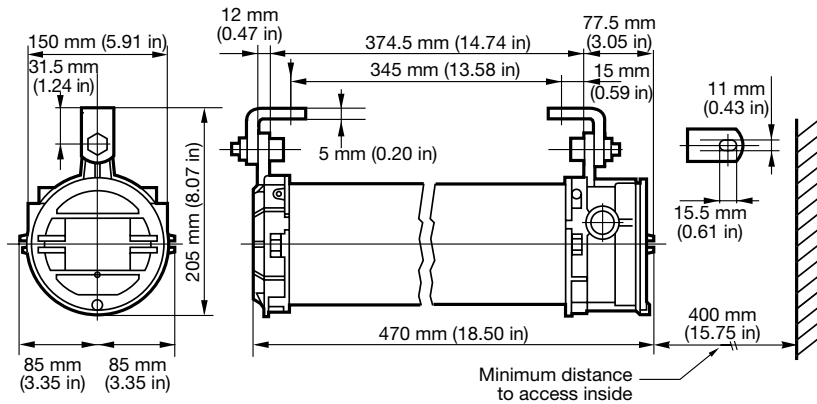

Switched Versions

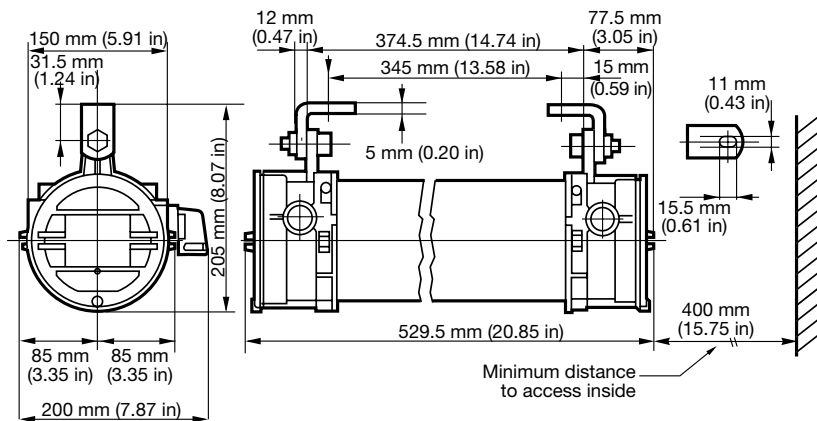

LED/ATEX/IECEX BULKHEAD

Appleton

ATX™ FNES LED Series Self-Contained Emergency Lighting

Zone 2 - 21 and 22. With Self-Test System

ATEX/IECEX:
Zone 2 - 21 and 22
II 2 D and II 3 GD
IP66/67 - IK10

Applications

- Provides adequate lighting and/or visual indication of access and exit routes during an evacuation in a hazardous environment.
- Can be installed in hazardous areas designated as Zone 2 – 21 and 22.
- Typical applications include oil refineries, petrochemical plants, pulp, paper mills and silos.

Features

- Power supply 230 Vac, 50/60 Hz.
- 3 hour duration (emergency).
- Non-maintained.
- Operates in any position.
- Battery pack.
 - Escape route lighting: 2.4 V - 1.5 Ah (2 cells - Nicd).
 - Space lighting: 7.2 V - 2.2 Ah (6 cells - NiMh) - Flameproof.
- Open and close using an Allen key (size 10) or a 6 mm flat screwdriver.
- Connection to plug-in terminal block via 2 x 5 x 2.5 mm² (0.003 x 0.008 x 0.004 in²) terminals.
- Two M20 clearance holes supplied with one cable gland – diameter 6.5 to 14.5 mm (0.26 to 0.57 in), one blanking plug and two locknuts.
- Charge indicator by green LED (lifetime over 10 years).
- Automatic built-in self-test system (SATI) with memorization of tests indicated by LEDs .
- Using a microprocessor and an internal clock, the unit will carry out automatic tests.
- Weekly test: Lamp check duration 6 seconds.
- Quarterly test: Emergency operation and lamp check for 1 hour.
- Can be remotely controlled and checked without switching the mains off with remote control unit from Legrand (Catalog Number 03901) or URA (Catalog Number 095448 and 095450) manufacturers.
- The remote control unit installed in a safe area or inside a flameproof box allows manual ignition of all the units (max. 300 units) for visual inspection of their operation.
- Escape route lighting: 55 lumens, 0.50 wattage.
- Space lighting: 540 lumens, 0.95 wattage.

Standard Materials

- Body: fiberglass reinforced polyester
- Diffuser (hinged to body): polycarbonate
- Gasket: elastomer
- Fixing brackets: zinc plated steel, gray painted aluminum or 316 stainless steel
- Cable gland and blanking plug: polyamide
- Locknut: nickel-plated brass

Options

- Addressable versions:
 - Operates without additional control lines. Communication between units and the control system is realized via mains borne signals that utilize the existing electrical wiring.
 - Standard control system capacity: one control system for up to 200 emergency lighting units.



FNES LED

- Optional increased control system capacity: booster (repeater unit) is used to increase the length of the network allowing up to 1000 emergency lighting units to be on one control system. This allows for the use of a single computer to centralize the management of the facilities emergency lighting system. For more information, please contact your local sales representative.
- Addressable monitoring software is available, please consult your local sales representative.
- Low temperature application, please consult your local sales representative.

ATEX/IECEX Certifications and Compliances

- Certification Type: FLn
 - Gas: Zone 2
 - Conforming to ATEX 94/9/CE: Ⓢ II 3 G
 - Type of Protection 'nA': Type of Protection 'nA'
 - Type of Protection 'nR': Ex nR IIC T4 Gc
 - Temperature class: T6 (nA) or T4 (nR)
 - Ambient Temperature: -20 °C to +55 °C (-4°F to +131 °F) ①
 - Dust: Zone 21
 - Conforming to ATEX 94/9/CE: Ⓢ II 2 D
 - Type of Protection: Ex tD A21
 - Surface Temperature: T75 °C (T167 °F)
 - Ambient Temperature: -40 °C to +55 °C (-40 °F to +131 °F) ①
 - Dust: Zone 22
 - Conforming to ATEX 94/9/CE: Ⓢ II 3 D
 - Type of Protection: Ex t IIC Dc
 - Surface Temperature: T75 °C (T167 °F)
 - Ambient Temperature: -20 °C to +55 °C (-4°F to +131 °F) ①
- CE Declaration of Conformity: 50212
- ATEX Certificate: LCIE 03 ATEX 6072 (Zone 2-22), LCIE 02 ATEX 6067 (Zone 21)
- IECEx Certificate: IECEx LCI 04.0021 (Zone 2-22)
- Index of Protection according EN/IEC 60529: IP66/67
- Impact Resistance (shock): IK10
- Conforming to NF AEAS

EURASEC Certification

- EURASEC N° TC RU C-FR.Г505.B.00912

Other Certification

- INMETRO Certificate: BVC11.0815 ②

Related Products

- For labels see *Labels for Emergency Lighting Units, ATX Self-Adhesive Signaling Labels for Emergency Lighting Units.*

① Optimum operating temperature for battery is -5 °C to +30 °C (+23 °F to +86 °F).

② Inmetro certification available on special request only. Contact your local sales representative for more information.

ATX™ FNES LED Series Self-Contained Emergency Lighting

Zone 2 - 21 and 22. With Self-Test System

ATEX/IECEX:
 Zone 2 - 21 and 22
 Ⓢ II 2 D and II 3 GD
 IP66/67 - IK10

Catalog Numbering Guide

FNES
 |
 Series:
 FNES - FNES Series
 Zone 2 and 22: ATEX/IECEX
 Certified
 Zone 21: ATEX Certified

LED
 |
 Lamp Type:
 LED

SL
 |
 SL - Space Lighting
 E - Escape Route Lighting

U
 |
 Cable Entry:
 A - Armored M20
 U - Unarmored M20
 N - Unarmored M25

A
 |
 Options:
 A - Addressable
 W - With Switch
 (Automatic mains cut-off)

Unswitched Version – 1 hour duration - Non-maintained - Two Unarmored M20 clearance entries

Type	Lamp Type	Lumen Output	Weight kg (lb)	Volume dm ³ (in ³)	Catalog Number
Space Lighting	LED Array	540 lm	7.2 (15.87)	32.3 (1971.1)	FNESLEDSLU
Escape Route Lighting	LED Array	55 lm	7.2 (15.87)	32.3 (1971.1)	FNESLEDEU

LED/ATEX/IECEX BULKHEAD







ATX™ FNES LED Series Self-Contained Emergency Lighting

Zone 2 - 21 and 22. With Self-Test System

ATEX/IECEX:
 Zone 2 - 21 and 22
 II 2 D and II 3 GD
 IP66/67 - IK10

Accessories

	Description	Catalog Number
	Half Clamps Brackets - Set of Two	
	Diameter for 1-1/4 to 1-1/2" pole: 42 mm (1.65 in) to 49 mm (1.93 in)	
	Zinc plated steel	FEHC49Z
	316 stainless steel	FEHC49S
	Diameter for 2" pole: 60 mm (2.36 in)	
	Zinc plated steel	FEHC60Z
	316 stainless steel	FEHC60S
	M8 Ring Bolts - Set of Two	
	Zinc plated steel	FERBM8Z
	Hinged Brackets - Set of two brackets for adjusting luminaire when wall-mounted	
	Aluminium (gray painted)	FEHBA
	316 stainless steel	FEHBS
	Brackets for Surface Mounting - Set of two	
	Aluminium (gray painted)	FESBA
	316 stainless steel	FESBS
	Fixing Brackets - Set of two brackets for ease of surface installation	
	Zinc plated steel	FEFBZ
	316 stainless steel	FEFBS

LED/ATEX/IECEX BULKHEAD

Appleton®

ATX™ FNES LED Series Self-Contained Emergency Lighting

Zone 2 - 21 and 22. With Self-Test System

ATEX/IECEX:
 Zone 2 - 21 and 22
 II 2 D and II 3 GD
 IP66/67 - IK10

Electrical Wiring Diagram

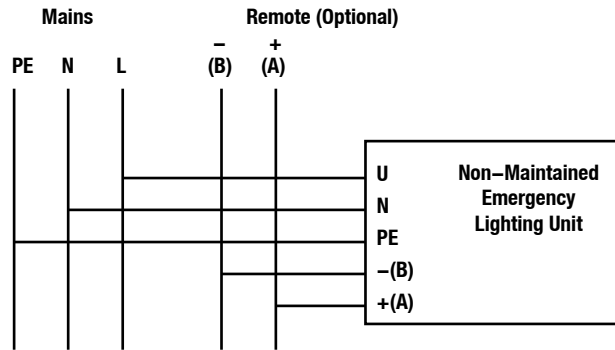

LED Indicator

Main Status	Non Maintained		Battery not Connected or Faulty	Main Power ON
	Space Lighting	Escape Route Lighting		
Switched On	☀ ● ● ● ● ● ● ☀	● ✕ ✕ ✕ ✕ ✕ ✕ ●	SATI	⦿ ⦿ ● ● ● ● ● ● ⦿
Switched Off	● ☀ ☀ ☀ ☀ ☀ ☀ ●	● ☀ ☀ ☀ ☀ ☀ ☀ ●	Addressable	⦿ ● ● ● ● ● ● ● ●
● OFF			● OFF	
☀ ON (high lighting power)			⦿ ON – Flashing – White LED	
✕ ON (low lighting power)			⦿ ON – Flashing – Amber LED	

Dimensions in Millimeters (Inches)

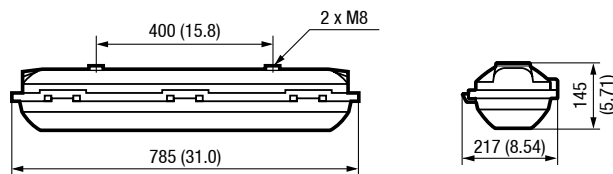

Mercmaster™ III Induction Luminaires

Enclosed and Gasketed. For Hazardous and Adverse Locations

NEC/CEC:
Class I, Division 2, Groups A, B, C, D
Class II, Division 1 and 2, Groups E, F, G
NEMA 4X

NEC/CEC:
Class I, Zone 2
AEx nA nR, IIC
Ex nA nR IIC

Applications

- Areas where access for relamping is difficult, reliability is essential and the environment is costly to maintain.
- Cold environment applications.
- Enclosed and gasketed fixtures suitable for use in marine and wet locations, and in a wide range of industrial, chemical processing and other areas where flammable gases and vapors or combustible dusts are present under conditions defined by NEC Class I, Division 2.
- Fixtures are also well suited for use in non-hazardous areas where severe weather conditions, excessive moisture, dirt, dust and corrosive atmospheres are a problem.
- Typical applications include pulp and paper mills, processing plants, chemical plants, oil refineries, foundries, manufacturing plants, storage areas and marine applications. Fixtures have NEMA 4X listing.

Features

- Instant start and restrike.
- High lumen output and efficacy (up to 73 lumens per Watt).
- Fixtures operate safely in a 40 °C (104 °F) ambient.
- Good lumen maintenance provides less than 30% depreciation after 60K hours of operation.
- Virtually maintenance free.
- Ultra long 100,000 hours of life keeps maintenance costs to a minimum.
- Starts in temperatures as low as -40 °C (-40 °F).
- Low total harmonic distortion (less than 10%).
- No cycling at end of life.
- Modular design allows scores of fixture component combinations to meet installation and lighting needs.
- Mounting hoods include cone-shaped pendant, standard pendant, flexible pendant, ceiling and wall (tapped for 3/4" or 1" NPT), 25° angle stanchion and straight stanchion (both tapped for 1-1/4" or 1-1/2" NPT).
- Cone hood fixtures for pendant mounting shed dust, dirt and combustible fibers, and inhibit build-up that "insulates" fixture and slows heat transfer. Also provide increased surface area for more effective heat dissipation.
- Reflector choice includes standard dome and 30° angle types, both made of fiberglass reinforced white polyester. Highly resistant to unusually corrosive applications. Reflectors are vented for cooler, dirt-free operation and maintained lumen output. They secure to ballast housing with stainless steel screws threading into stainless steel inserts.
- For high corrosion resistance, fixture housing, mounting hoods and guards are copperfree (4/10 of 1% max.) cast aluminum with baked epoxy finish, electrostatically applied for uniformity. All exposed hardware is stainless steel.
- Hinge has high lip for added safety during installation and servicing. Hinge and bolt construction assures 360° compression at all points on ballast housing gasket for positive sealing. Swing-away design of captive bolt and nut simplifies servicing.
- Body gaskets and globe gaskets are high-temperature silicone rubber.
- All Mercmaster III mounting hoods have provision for easy field installation of fuses in fixtures (see fuse kit listings in this catalog section).
- For electrical protection, a ground wire is provided on each Mercmaster to bond hood and ballast housing.



**85 Watt Wall Mount Fixture with
Prismatic Glass Globe**

Standard Materials

- Mounting hoods, ballast bodies and guards: cast copperfree (4/10 of 1% max.) aluminum
- Exposed hardware: stainless steel; latch assemblies have stainless steel bolt and captive nut; reflectors and guards attach with stainless steel screws threading into stainless steel inserts
- Reflectors: fiberglass reinforced white polyester
- Globes: heat-resistant prismatic glass

Standard Finishes

- Mounting hoods, ballast bodies, guards: epoxy powder coat finish, electrostatically applied for complete, uniform surface protection
- Reflectors: white polyester finish

Options

- Fuses can be field-installed on Mercmaster III fixtures. Kits include fuse block, wire connectors and screws for attaching to mounting hood. Fixtures with fuses do not comply with Marine Type Electric Fixtures Outside Type (Salt Water) requirements for marine listing.
- Photocell optional for all fixtures except cone and ceiling mounts; provides automatic "on-off" control.

NEC/CEC Certifications and Compliances

- UL Standard: UL 1598, UL 844, UL 1598A
- CSA Standard: C22.2 No. 250, C22.2 No. 137
- cCSAus Certified

Mercmaster™ III Induction Luminaires

Enclosed and Gasketed. For Hazardous and Adverse Locations

NEC/CEC:
Class I, Division 2, Groups A, B, C, D
Class II, Division 1 and 2, Groups E, F, G
NEMA 4X

NEC/CEC:
Class I, Zone 2
AEx nA nR, IIC
Ex nA nR IIC

Illustrated Features



Aluminum Inner Reflector

Solid aluminum inner reflector improves photometric efficiency.

Epoxy Finish

Ballast housing, hoods and guards are copperfree aluminum with epoxy powder coat finish.

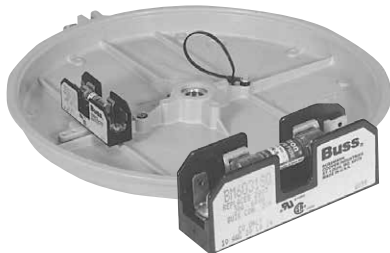

Fuses Mount to Hood Bosses

Two screws secure fuse kit to mounting boss in any Mercmaster mounting hood.

Electrical Protection

Ground wire provided to bond mounting hood to ballast housing.



Stainless Steel Latch Assembly

Captive, stainless steel latch assembly bolt and nut closes securely, resists attack of corrosive atmospheres. Swing-away design simplifies servicing.



Rugged, Vented Reflectors

Reflectors are thick, tough fiberglass reinforced white polyester, vented for cooler operation. Quickly attach with stainless steel screws provided.

Threaded Stainless Steel Inserts for Screws

Fixture bodies have stainless steel threaded inserts to receive stainless steel screws for reflector and guard. Prevents "freezing", allowing guards and reflectors to be easily removed and replaced at any time, without damage to the housing.

Prismatic Glass Globes, Refractors and Enclosed Reflector

Heat-resistant globes, refractors and enclosed reflectors thread into ballast housing and seal against a high-temperature silicone rubber gasket.



Mounting Hood and Globe Gaskets

Silicone rubber gaskets seals out moisture, dirt and dust. Stays flexible, withstands high temperatures. Closure design assures uniform gasket compression.



Cooler Operating Cone Hood

Sloped surface sheds insulating dust, dirt, and combustible fibers. Provides cleaner, larger surface area for better heat dissipation.

Photocell

Available for all fixtures except cone and ceiling mount. Installs through knock-out in mounting hood. Provides continuous ON-OFF dusk-to-dawn control.



"Safety" High Hinge

Extra-high hinge provides additional protection against accidental ballast housing disengagement during installation or maintenance.

Mercmaster™ III Induction Luminaires

Enclosed and Gasketed. For Hazardous and Adverse Locations

NEC/CEC:
 Class I, Division 2, Groups A, B, C, D
 Class II, Division 1 and 2, Groups E, F, G
 NEMA 4X

NEC/CEC:
 Class I, Zone 2
 AEx nA nR, IIC
 Ex nA nR IIC

Mercmaster III Induction Family Tree

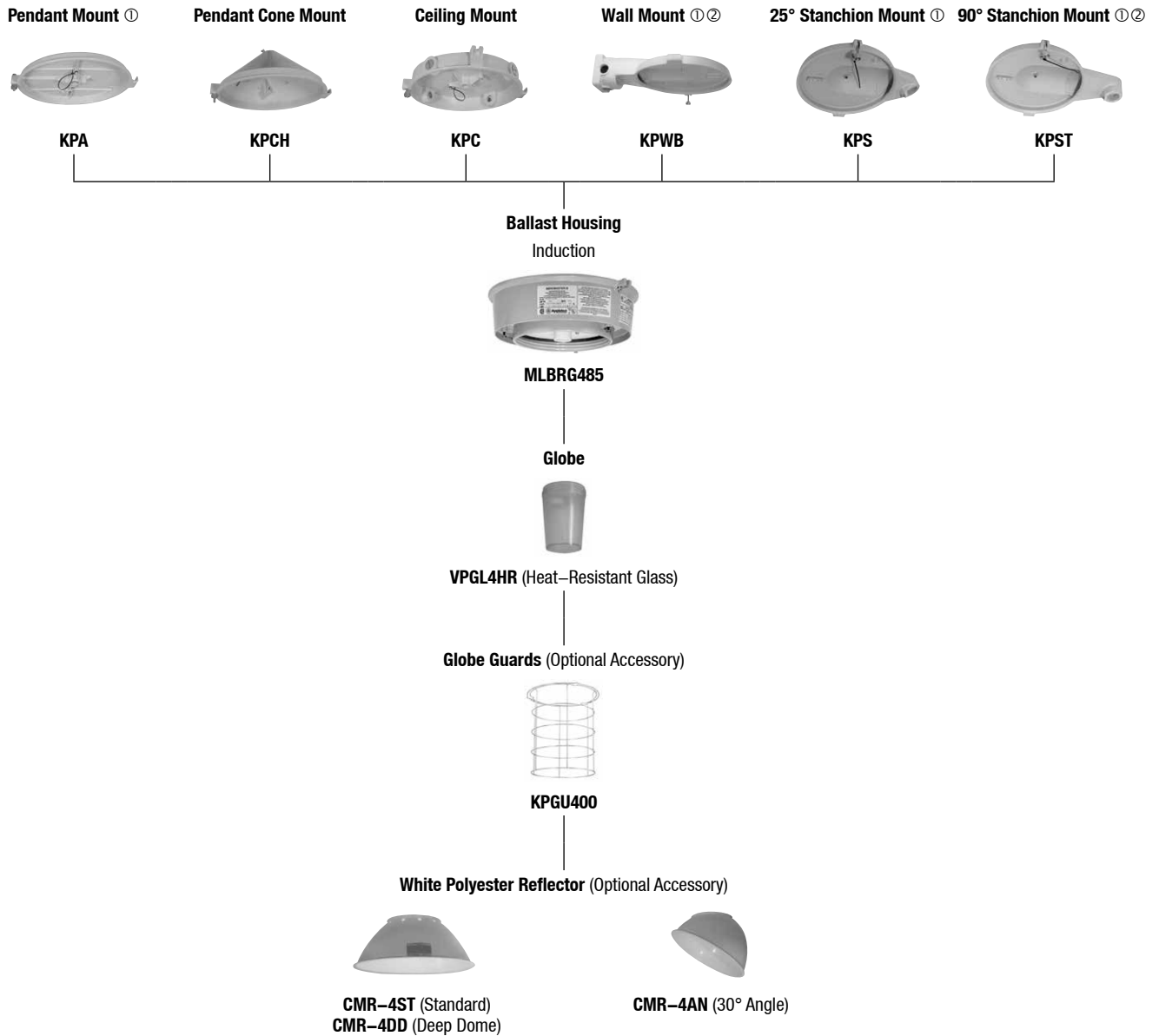

① Mounting hood with a 120 V or 208-277 V factory installed photocell is available.

② Standard and deep dome reflectors may interfere with bottom conduit entry if used with KPST and KPWB mounting hoods..

Mercmaster™ III Induction Luminaires

Enclosed and Gasketed. For Hazardous and Adverse Locations

NEC/CEC:
 Class I, Division 2, Groups A, B, C, D
 Class II, Division 1 and 2, Groups E, F, G
 NEMA 4X

NEC/CEC:
 Class I, Zone 2
 AEx nA nR, IIC
 Ex nA nR IIC

“T” Numbers for Mercmaster III Induction Fixtures — Class I, Division 2 and Class II, Division 1 and 2

Lamp Watts	Lamp Type	Supply Wire Temp. °C (°F)	Ambient Temp. °C (°F)	Input Voltage	Class I, Division 2, Groups A, B, C, D NEC/CEC Temp. Indent. Number Nameplate Marking			Class II, Division 1 and 2, Groups E, F, G NEC/CEC Temp. Indent. Number Nameplate Marking		
					with Globe or Reflector	with Refractor	with Enclosed Reflector	with Globe or Reflector	with Refractor	with Enclosed Reflector
85	Induction	90 (194)	40 (104)	100-120	T3A	—	—	T6	—	—
85	Induction	90 (194)	40 (104)	200-277	T3A	—	—	T6	—	—

“T” Numbers for Mercmaster III Induction Fixtures — Class I, Zone 2

Lamp Watts	Lamp Type	Supply Wire Temp. °C (°F)	Ambient Temp. °C (°F)	Input Voltage	Class I, Zone 2 AEx nA nR IIC / Ex nA nR IIC		Class I, Zone 2 AEx nR IIC / Ex nR IIC			
					with Globe	with Globe and Reflector	with Globe	with Globe and Reflector	with Refractor	Reflector with Lens
85	Induction	90 (194)	40 (104)	100-120	T4	T4	—	—	—	—
85	Induction	90 (194)	40 (104)	200-277	T4	T4	—	—	—	—

“T” Numbers Represent the Maximum Lamp Temperature for Class I, Division 2 Locations and Maximum Surface Temperature Under Dust Blanket for Class II, Division 1 Locations.



“T” Number	T1	350	325	T2	T2A	T2B	T2C	T2D	T3	T3A	T3B	T3C	T4	T4A	T5	T6
Temp Range (°C)	351-450	326-350	301-325	281-300	261-280	231-260	216-230	201-215	181-200	166-180	161-165	136-160	121-135	101-120	86-100	85
Temp. Range (°F)	664-842	619-662	574-617	538-572	502-536	448-500	421-446	394-419	358-392	331-356	322-329	277-320	250-275	214-248	187-212	185

Mercmaster™ III Induction Luminaires

Enclosed and Gasketed. For Hazardous and Adverse Locations

NEC/CEC:
 Class I, Division 2, Groups A, B, C, D
 Class II, Division 1 and 2, Groups E, F, G
 NEMA 4X

NEC/CEC:
 Class I, Zone 2
 AEx nA nR, IIC
 Ex nA nR IIC

	Type Mounting	Lamp Watts	Hub Size (Inches)	Catalog Numbers ①②③ with Globe
 Shown with Globe	Pendant			
	One Hub Rigid Mounting ④	85 ⑤⑥	3/4	MLAQ852G4N
 Shown with Globe	Pendant Cone Hood			
	One Hub Rigid Mounting	85 ⑤⑥	3/4	MLDQ852G4N
 Shown with Refractor	Ceiling			
	Five Hubs Four Close-Up Plugs	85 ⑤⑥	3/4	MLCQ852G4N
			1	MLCQ853G4N

- ① Add voltage suffix **-A1** for 120 Vac: 90-140 Vac; **-A6** for 277: 180-305 Vac.
- ② See following pages for accessory ordering information.
- ③ For fixtures with guard, substitute **G** for **N** before adding suffix.
- ④ For flexible pendant mount, change **A** to **F** in catalog number.
- ⑤ Add **Z2** suffix for factory sealed non-sparking/restricted breathing protection (AEx nA nR).
- ⑥ Add **Z** suffix for factory sealed non-sparking/restricted breathing protection (Ex nA nR).

Mercmaster™ III Induction Luminaires



Enclosed and Gasketed. For Hazardous and Adverse Locations

NEC/CEC:
Class I, Division 2, Groups A, B, C, D
Class II, Division 1 and 2, Groups E, F, G
NEMA 4X

NEC/CEC:
Class I, Zone 2
AEx nA nR, IIC
Ex nA nR IIC

Appleton

INDUCTION/AREA: NEC/CEC ENCLOSED AND GASKETED

	Type Mounting	Lamp Watts	Hub Size (Inches)	Catalog Numbers ^{①②③} with Globe
 Shown with Globe	Wall		3/4	MLWQ852G4N
	Five Hubs Four Close-Up Plugs	85 ^{④⑤}	1	MLWQ853G4N
 Shown with Globe	25° Stanchion		1-1/4	MLSQ854G4N
	One Hub	85 ^{④⑤}	1-1/2	MLSQ855G4N
 Shown with Globe	Straight Stanchion		1-1/4	MLRQ854G4N
	One Hub	85 ^{④⑤}	1-1/2	MLRQ855G4N

① Add voltage suffix **-A1** for 120 Vac: 90-140 Vac; **-A6** for 277: 180-305 Vac.

② See following pages for accessory ordering information.

③ For fixtures with guard, substitute **G** for **N** before adding suffix.

④ Add **Z2** suffix for factory sealed non-sparking/restricted breathing protection (AEx nA nR).

⑤ Add **Z** suffix for factory sealed non-sparking/restricted breathing protection (Ex nA nR).







Mercmaster™ III Induction Luminaires

Enclosed and Gasketed. For Hazardous and Adverse Locations

NEC/CEC:
 Class I, Division 2, Groups A, B, C, D
 Class II, Division 1 and 2, Groups E, F, G
 NEMA 4X

NEC/CEC:
 Class I, Zone 2
 AEx nA nR, IIC
 Ex nA nR IIC

Mounting Hoods

	Description	Hub Size (Inches)	Catalog Number
Pendant			
	One Hub, Rigid Mounting	3/4 1	KPA-75 KPA-100
Pendant – Flexible			
	One Hub, Flexible Mounting	3/4 1	KPAF-75 KPAF-100
Pendant Cone			
	Cone Hood Rigid Mounting	3/4 1	KPCH-75 KPCH-100
Ceiling			
	Five Hubs, Four Close-Up Plugs	3/4 1	KPC-75 KPC-100
Wall			
	Five Hubs, Four Close-Up Plugs	3/4 1	KPWB-75 KPWB-100
25° Stanchion			
	One Hub	1-1/4 1-1/2	KPS-125 KPS-150
90° Stanchion			
	One Hub	1-1/4 1-1/2	KPST-125 KPST-150

Mercmaster™ III Induction Luminaires

Enclosed and Gasketed. For Hazardous and Adverse Locations

NEC/CEC:
Class I, Division 2, Groups A, B, C, D
Class II, Division 1 and 2, Groups E, F, G
NEMA 4X

NEC/CEC:
Class I, Zone 2
AEx nA nR, IIC
Ex nA nR IIC



Appleton

INDUCTION/AREA: NEC/CEC ENCLOSED AND GASKETED

Fixture Units – Less Mounting Hoods

	Type	Frequency	Fixture Unit Catalog Number	Add Voltage Suffixes	
				120 V	277 V
Globe					
	Induction	50/60 Hz	MLBRG485Q	-A1	-A6

Accessories and Replacement Parts

Item	Description	Catalog Number
White Polyester Reflectors		
	Standard Dome	CMR-4ST ①
	Deep Dome (Dark Skies Compliant)	CMR-4DD ①
	30° Angle	CMR-4AN ①

Prismatic Glass Globes – Heat-Resistant

	Clear	VPGL-4HR
---	-------	-----------------

Guards

		KPGU400
---	--	----------------

Mercmaster III Fixture Unit, Component and Accessory Weights ②

Fixture Unit and Mounting Hoods	Wt. kg (lbs)	Reflectors	Wt. kg (lbs)	Reflectors, Globes and Guard	Wt. kg (lbs)
Fixture	12.7 (28.00)	Standard Dome	1.1 (2.50)	Glass Globe	1.7 (3.75)
Pendant	1.0 (2.25)	30° Angle	1.1 (2.50)	Globe Guard	0.5 (1.00)
Pendant Cone	1.1 (2.50)	Deep Dome	1.6 (3.50)		
Ceiling	1.4 (3.00)				
Wall	1.8 (4.00)				
25° Stanchion	1.5 (3.25)				
90° Stanchion	1.5 (3.33)				

① Standard and deep dome reflectors may interfere with bottom conduit entry if used with KPST and KPWB mounting hoods.

② Weights are approximate.

Mercmaster™ III Induction Luminaires

Enclosed and Gasketed. For Hazardous and Adverse Locations

NEC/CEC:
 Class I, Division 2, Groups A, B, C, D
 Class II, Division 1 and 2, Groups E, F, G
 NEMA 4X

NEC/CEC:
 Class I, Zone 2
 AEx nA nR, IIC
 Ex nA nR IIC

Fuse Kit includes fuse, fuse holder and necessary hardware for field installation. Mounts easily to hood with one screw. ①

Lamp Watts	Volts	Fuse Qty. Req.
85	120/277	1
	208-240	2

Electromagnetic Compatibility

- A.) Complies with European norms EN55015, EN6100-3-2 and EN61547
 B.) RFI
 a.) Meets standard EN55022 and is valid for frequencies up to 1000 MHz.

Electrical Characteristics

		85 W 100–120 V	85 W 200–277 V
System power ② nom.	W	85	85
System power ② min.	W	82	82
System power ② max.	W	88	88
AC supply voltage nom.	V	120	230
AC supply voltage min.	V	90	180
AC supply voltage max.	V	140	305
DC supply voltage nom.	V	120	230
DC supply voltage min.	V	90	180
DC supply voltage max.	V	180	350
Supply frequency nom.	Hz	60	50
Supply frequency min.	Hz	47	47
Supply frequency max.	Hz	63	63
Supply current nom.	mA	730	400
Inrush current max.	A	16	12
Duration inrush current max.	usec	170	170
Power factor nom.		>0.92	>0.92
HF output frequency nom.	MHz	2.65	2.65
HF output frequency min.	MHz	2.3	2.3
HF output frequency max.	MHz	3	3
HF output voltage max.	kV	1.5	1.5
Leakage current	mA	<0.5	<0.5
Overvoltage		200Vac	400Vac

Lamp Characteristics

	Values at 100 Hrs.	QL 85 W
Luminous flux nom.	lm	6,000
Luminous flux min.	lm	5,500
Luminous flux max.	lm	6,500
System efficacy nom.	lm/W	70

Lamp Operation

- A.) Ignition and Lifetime Performance
 a.) Ignition time <0.5 seconds
 Hot Restrike time <0.5 seconds
 b.) Induction lighting offers a direct, flicker-free ignition after switch-on, in both cold and hot conditions
 B.) Lumen Maintenance
 a.) The lumens of an induction lamp are expected to have depreciated after 60,000 hours to no less than 75% of the initial lumens

① Canadian Electrical Code does NOT allow fusing in hazardous locations.

② At design voltage.

Mercmaster™ III Induction Luminaires

Enclosed and Gasketed. For Hazardous and Adverse Locations

Appleton

INDUCTION/AREA: NEC/CEC ENCLOSED AND GASKETED

NEC/CEC:
 Class I, Division 2, Groups A, B, C, D
 Class II, Division 1 and 2, Groups E, F, G
 NEMA 4X

NEC/CEC:
 Class I, Zone 2
 AEx nA nR, IIC
 Ex nA nR IIC

Dimensions in Millimeters (Inches)

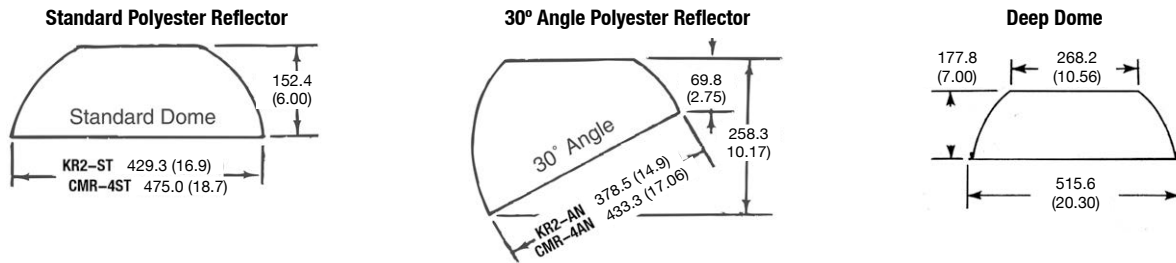
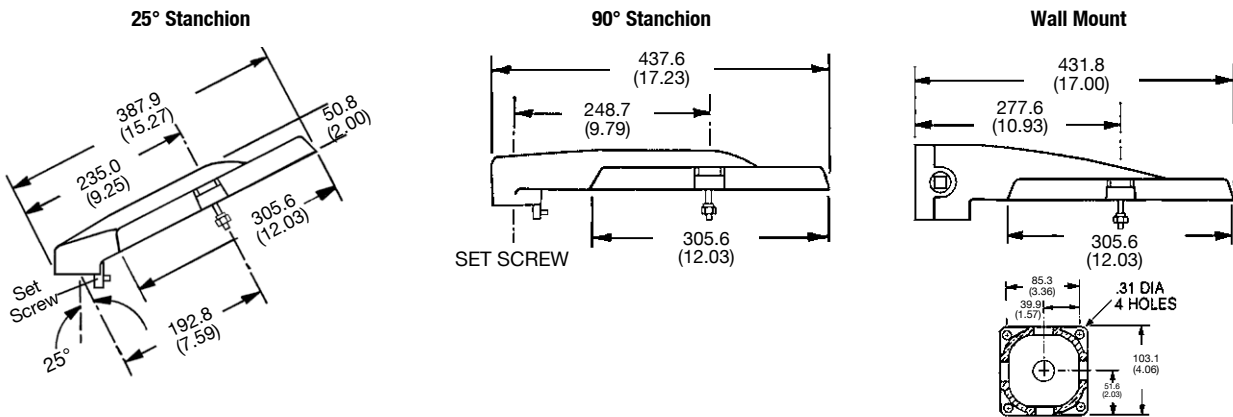
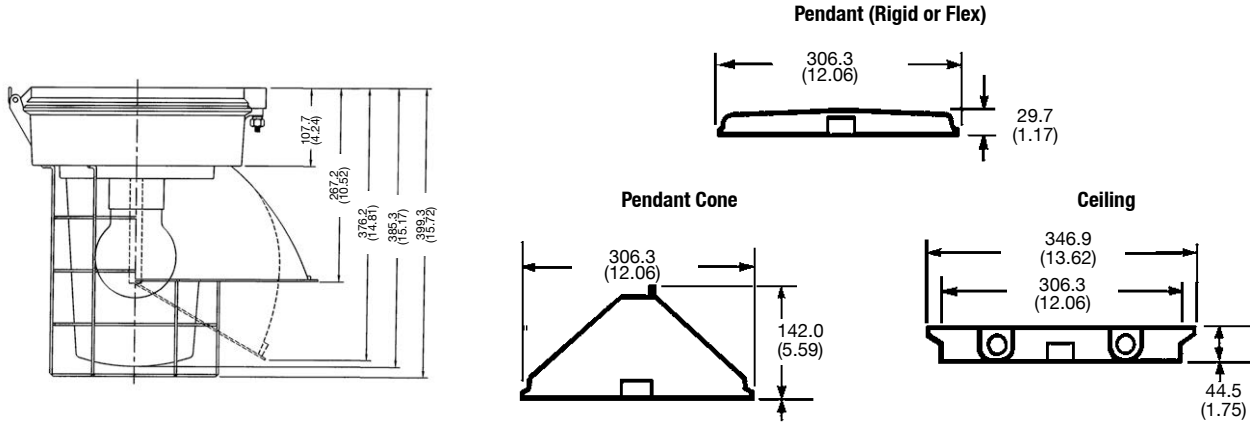

PCD2 Series Factory Sealed Hazardous Location Photocontrol

For use in Class I, Division 2, Groups A, B, C, D locations

Maintains Class I, Division 2 rating for Mercmaster III – Low Profile, Mercmaster III, and Mercmaster III – 400 Series Luminaires, Mercmaster LED

NEC/CEC:
Class I, Division 2, Groups A, B, C, D
NEMA 4X

Applications

- Encapsulated photocontrol provides automatic dusk-to-dawn lighting control in Class I, Division 2 locations.
- Typical applications include walkways, security areas and any other outdoor lighting application.
- For use with Mercmaster III – Low Profile, Mercmaster III, and Mercmaster III – 400 Series Luminaires.
- For remote mounting in FS Boxes.

Features

- Factory sealed design eliminates the need for an explosionproof enclosure.
- Can be easily installed in the field.
- Solid state design for performance and reliability.
- Available for 120, 208, 240, or 277 volts.

- 50-400 W HID, incandescent or fluorescent, 50/60 Hz.
- 1000 V.A. Voltage/Ampere
- Minimum time delay: 15 seconds to eliminate nuisance tripping.
- Provided with (3) 18AWG stranded leads 152.4 mm (6.00 in) length.
- Will fit through standard 1/2" knockout.
- Supplied with locknut and gasket.

Materials

- Encapsulated with epoxy sealing compound
- FS: aluminum

NEC/CEC Certifications and Compliances

- UL Standard: 1604 – Hazardous (Classified) Locations
- cULus Recognized

	Voltage Range	Max VA	Max Current Amps	Suffix Designation Catalog Number
Factory-Installed Photocontrol - Not for ceiling or pendant cone. <i>Add to fixture catalog after voltage; i.e.: KPWBL1075MTH1.</i>				
	120 V, 50/60 Hz	1000	—	H1
	208 V, 50/60 Hz	1000	—	H2
	240 V, 50/60 Hz	1000	—	H3
	277 V, 50/60 Hz	1000	—	H4

Photocontrol for Field Installation

	120 V, 50/60 Hz	1000	8.3 Amp	PC120D2
	208 V, 50/60 Hz	1000	4.8 Amp	
	240 V, 50/60 Hz	1000	4.2 Amp	PC247D2
	277 V, 50/60 Hz	1000	3.6 Amp	

Photocontrol in FS Cover for Use with FS/FD Box

Supplied with two stainless steel screws. For neoprene gasket, order catalog number FS-GKR-1N.

	120V, 50/60 Hz	1000	8.3 Amp	FSKA-PC120D2
	208, 50/60 Hz	1000	4.8 Amp	FSKA-PC247D2
	240 V, 50/60 Hz	1000	4.2 Amp	
	277 V, 50/60 Hz	1000	3.6 Amp	

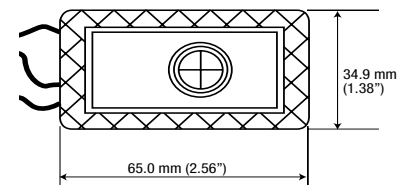
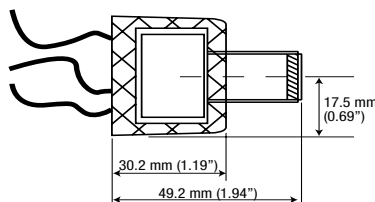
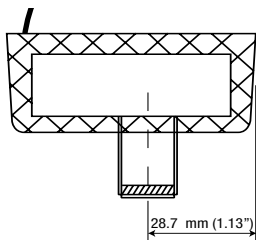

Mercmaster™ III Induction Luminaires

Enclosed and Gasketed. For Hazardous and Adverse Locations

NEC/CEC:
Class I, Division 2, Groups A, B, C, D
Class II, Division 1 and 2, Groups E, F, G
NEMA 4X

NEC/CEC:
Class I, Zone 2
AEx nA nR, IIC
Ex nA nR IIC

Photometric Data

Total Luminaire Efficiency = 78.4%

CIE Type – General Diffuse

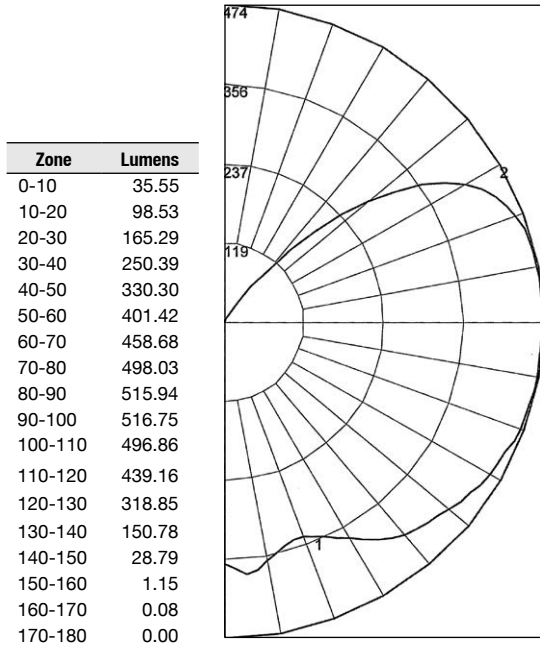

REPORT NUMBER: **MLBR85QL**

Lamps: 85 W QL lamp with Globe only

Coefficients of Utilization – Zonal Cavity Method

Effective Floor Cavity Reflectance 0.20

% Ceiling Rcc	% Walls Rw	80				70				50			30			10			0		
		70	50	30	10	70	50	30	10	50	30	10	50	30	10	50	30	10	0		
0		86	86	86	86	80	80	80	80	69	69	69	59	59	59	50	50	50	46		
1		74	69	64	60	68	64	59	56	54	51	48	46	43	41	38	36	34	30		
2		66	58	51	46	60	53	47	42	45	41	36	38	34	31	31	28	25	22		
3		59	49	42	36	54	46	39	34	39	33	29	32	28	24	26	23	20	17		
4		53	43	35	29	49	40	33	27	34	28	24	28	23	20	23	19	16	13		
5		49	38	30	25	45	35	28	23	30	24	20	25	20	17	20	16	13	11		
6		45	34	26	21	41	31	24	19	26	21	17	22	17	14	18	14	11	9		
7		41	30	23	18	38	28	21	17	24	18	14	20	15	12	16	13	10	8		
8		38	27	20	16	35	25	19	14	21	16	12	18	14	11	15	11	9	7		
9		35	25	18	14	33	23	17	13	20	15	11	16	12	9	13	10	8	6		
10		33	23	16	12	30	21	15	11	18	13	10	15	11	8	12	9	7	5		

Zonal Lumen Summary

Zone	Lumens	% Lamp	% Fixture	Zone	Lumens	% Lamp	% Fixture
0-30	299.37	5.0	6.4	90-120	1452.77	24.2	30.9
0-40	549.76	9.2	11.7	90-130	1771.62	29.5	37.6
0-60	1281.48	21.4	27.2	90-150	1951.19	32.5	37.6
0-90	2754.13	45.9	58.5	90-180	1952.42	32.5	41.5
				0-180	4706.55	78.4	100.0

Total Luminaire Efficiency = 69%

CIE Type – Direct

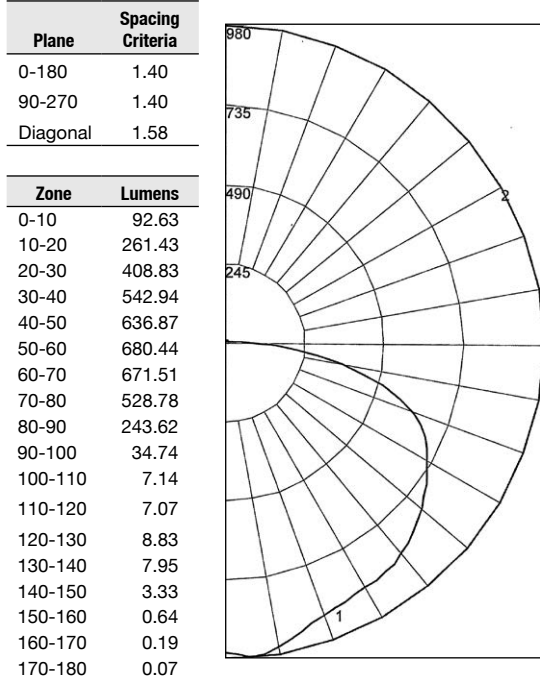

REPORT NUMBER: **MLBR85QLST**

Lamps: 85 W QL lamp with Standard Dome Reflector

Coefficients of Utilization – Zonal Cavity Method

Effective Floor Cavity Reflectance 0.20

% Ceiling Rcc	% Walls Rw	80				70				50			30			10			0		
		70	50	30	10	70	50	30	10	50	30	10	50	30	10	50	30	10	0		
0		82	82	82	82	80	80	80	80	76	76	76	72	72	72	69	69	69	68		
1		73	68	65	61	70	67	63	60	63	60	58	60	58	56	58	56	54	52		
2		65	58	52	47	63	56	51	47	54	49	45	51	47	44	49	46	43	41		
3		58	50	43	38	56	48	42	37	46	41	37	44	39	36	42	38	35	33		
4		53	43	36	31	51	42	36	31	40	35	30	38	34	30	37	33	29	27		
5		48	38	31	26	47	37	31	26	36	30	25	34	29	25	33	28	25	23		
6		44	34	27	22	43	33	27	22	32	26	22	31	25	22	29	25	21	20		
7		41	31	24	19	40	30	24	19	29	23	19	28	23	19	27	22	19	17		
8		38	28	21	17	37	27	21	17	26	21	17	25	20	17	24	20	16	15		
9		35	25	19	15	34	25	19	15	24	19	15	23	18	15	22	18	15	13		
10		33	23	18	14	32	23	17	14	22	17	13	21	17	13	21	16	13	12		

Zonal Lumen Summary

Zone	Lumens	% Lamp	% Fixture	Zone	Lumens	% Lamp	% Fixture
0-30	762.89	12.7	18.4	90-120	48.95	0.8	1.2
0-40	1305.83	21.8	31.6	90-130	57.78	1.0	1.4
0-60	2623.14	43.7	63.4	90-150	69.06	1.2	1.4
0-90	4067.06	67.8	98.3	90-180	69.96	1.2	1.7
				0-180	4137.02	69.0	100.0

Mercmaster™ III Induction Luminaires

Enclosed and Gasketed. For Hazardous and Adverse Locations

NEC/CEC:
Class I, Division 2, Groups A, B, C, D
Class II, Division 1 and 2, Groups E, F, G
NEMA 4X

NEC/CEC:
Class I, Zone 2
AEx nA nR, IIC
Ex nA nR IIC

Photometric Data

Total Luminaire Efficiency = 61.4%

CIE Type – Direct

Plane	Spacing Criteria
0-180	1.80
90-270	1.44
Diagonal	1.54

Zone	Lumens
0-10	81.53
10-20	231.27
20-30	367.34
30-40	487.91
40-50	542.61
50-60	528.65
60-70	475.60
70-80	400.17
80-90	296.45
90-100	173.50
100-110	69.93
110-120	16.29
120-130	6.47
130-140	4.19
140-150	1.67
150-160	0.59
160-170	0.44
170-180	0.10

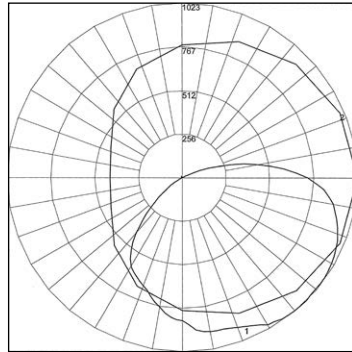

REPORT NUMBER: **MLBR85QLAN**

Lamps: 85 W QL lamp with 30° Angle Dome Reflector

Coefficients of Utilization – Zonal Cavity Method

Effective Floor Cavity Reflectance 0.20

% Ceiling Rcc	% Walls Rw	80				70				50			30			10			0
		70	50	30	10	70	50	30	10	50	30	10	50	30	10	50	30	10	0
0		72	72	72	72	70	70	70	70	66	66	66	62	62	62	58	58	58	57
1		64	60	56	53	61	58	55	52	54	52	50	51	49	47	48	46	45	43
2		57	51	46	42	55	49	45	41	46	43	39	44	40	38	41	38	36	34
3		52	44	38	34	49	43	37	33	40	36	32	38	34	31	36	32	30	28
4		47	39	33	28	45	38	32	28	35	31	27	33	29	26	31	28	25	23
5		43	34	28	24	41	33	28	23	31	26	23	30	25	22	28	24	21	20
6		39	31	25	20	38	30	24	20	28	23	20	27	22	19	25	21	19	17
7		36	28	22	18	35	27	21	18	25	21	17	24	20	17	23	19	16	15
8		34	25	20	16	33	24	19	16	23	19	15	22	18	15	21	17	14	13
9		32	23	18	14	30	22	17	14	21	17	14	20	16	13	19	16	13	12
10		30	21	16	13	29	21	16	12	20	15	12	19	15	12	18	14	12	11

Zonal Lumen Summary

Zone	Lumens	% Lamp	% Fixture	Zone	Lumens	% Lamp	% Fixture
0-30	680.15	11.3	18.5	90-120	259.73	4.3	7.0
0-40	1168.06	19.5	31.7	90-130	266.19	4.4	7.2
0-60	2239.32	37.3	60.8	90-150	272.06	4.5	7.2
0-90	3411.54	56.9	92.6	90-180	273.19	4.6	7.4
0-180	2684.73	61.4	100.0				

Total Luminaire Efficiency = 59.5%

CIE Type – Direct

Plane	Spacing Criteria
0-180	1.58
90-270	1.58
Diagonal	1.58

Zone	Lumens
0-10	111.69
10-20	339.29
20-30	563.74
30-40	754.34
40-50	811.90
50-60	595.64
60-70	288.96
70-80	91.02
80-90	13.32
90-100	0.00
100-110	0.00
110-120	0.25
120-130	0.46
130-140	0.28
140-150	0.41
150-160	0.00
160-170	0.07
170-180	0.04

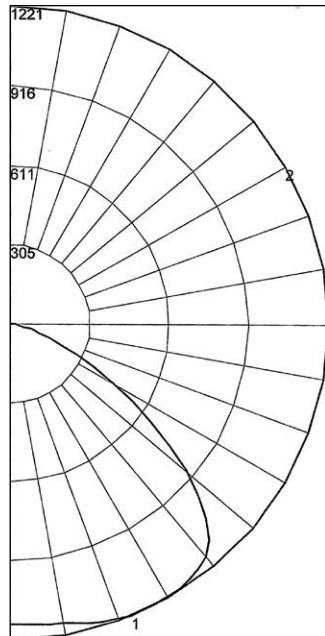

REPORT NUMBER: **MLBR85QLHB**

Lamps: 85 W QL lamp with High Bay Reflector

Coefficients of Utilization – Zonal Cavity Method

Effective Floor Cavity Reflectance 0.20

% Ceiling Rcc	% Walls Rw	80				70				50			30			10			0
		70	50	30	10	70	50	30	10	50	30	10	50	30	10	50	30	10	0
0		71	71	71	71	69	69	69	69	66	66	66	63	63	63	61	61	61	59
1		66	63	61	59	64	62	60	58	59	58	56	57	56	55	55	54	53	52
2		60	56	52	49	59	55	51	49	53	50	48	51	49	46	49	47	45	44
3		55	50	45	42	54	49	44	41	47	43	40	45	42	40	44	41	39	38
4		51	44	39	35	49	43	39	35	42	38	35	40	37	34	39	36	34	33
5		47	39	34	31	45	39	34	30	38	33	30	36	33	30	35	32	29	28
6		43	35	30	27	42	35	30	27	34	30	26	33	29	26	32	29	26	25
7		40	32	27	24	39	32	27	23	31	26	23	30	26	23	29	26	23	22
8		37	29	24	21	36	29	24	21	28	24	21	27	23	21	27	23	20	19
9		35	27	22	19	34	26	22	19	26	22	19	25	21	18	24	21	18	17
10		32	25	20	17	32	24	20	17	24	20	17	23	19	17	23	19	17	16

Zonal Lumen Summary

Zone	Lumens	% Lamp	% Fixture	Zone	Lumens	% Lamp	% Fixture
0-30	1014.71	16.9	28.4	90-120	0.25	0.0	0.0
0-40	1769.06	29.5	49.5	90-130	0.70	0.0	0.0
0-60	3176.60	52.9	88.9	90-150	1.39	0.0	0.0
0-90	3569.90	59.5	100.0	90-180	1.50	0.0	0.0
0-180	3571.40	59.5	100.0				

Mercmaster™ III Low Profile Luminaires

High Pressure Sodium and Pulse Start Metal Halide

Listed for simultaneous exposure to combustible dusts and flammable gases or vapors.

NEC/CEC:

Class I, Division 2, Groups A, B, C, D
Class I, Zone 2, AEx nA nR IIC (Z2)
Class I, Zone 2, AEx nR IIC (ZB)
Class II, Division 1 and 2, Groups E, F, G
Class III

NEC/CEC:

Simultaneous Exposure
(Class I, Division 2/Class II, Division 1)
Fixtures Outside Type (Salt Water)
Type 4X
IP66

Applications

- Enclosed and gasketed fixtures suitable for use in:
 - Marine and wet locations
 - A wide range of industrial, chemical processing and other areas where flammable gases and vapors or combustible dusts are present under conditions defined by the National Electrical Code as Class I, Division 2; Class II, Division 1 and 2; and Class III
 - Areas of low clearance, low ceiling heights or where fixture weights must be minimized
 - For Zone 2, the method of protection is AEx nA nR – Restricted Breathing/Nonsparking or AEx nR – Restricted Breathing
 - Non-hazardous locations where severe weather conditions, excessive moisture, dirt, dust, corrosive atmosphere or high ambient temperatures are encountered
- Typical applications include:
 - Pulp and paper mills
 - Processing plants
 - Chemical plants
 - Oil refineries
 - Foundries
 - Manufacturing plants
 - Storage areas
 - Waste and sewage treatment
 - Parking garages
 - Other areas where dust, water, dirt and rough usage are a problem

Features

- Compact light weight low profile design is suited for low mounting heights in conjunction with lower wattage fixtures.
- Modular design allows scores of fixture component combinations to meet installation and lighting needs. Uses same mounting hoods and optical accessories as Mercmaster III.
- A choice of heat-resistant prismatic glass refractors (NEMA I, III or V) or heat-resistant globes which thread directly into ballast housing. Photometrics available upon request – contact your local sales representative.
- Standard dome or 30° angle reflectors made of fiberglass reinforced white polyester. Highly resistant to corrosive atmospheres.
- Accommodates medium base lamps.
- A wide range of voltages available (120 to 600 Volt) and ballast types (Reactor, CWA and Super CWA).
- Medium base lamp type and watts:
 - HPS 50 W-150 W
 - PSMH 50 W-175 W
- Hinge has high lip for added safety during installation and servicing. Hinge and bolt construction assures 360° compression at all points on ballast housing gasket for positive sealing. Swing away design of captive bolt and nut simplifies servicing.
- All Mercmaster III mounting hoods have provision for easy field installation of fuses in fixtures (see fuse kits).
- Fixtures are for use in Class I, Zone 2 hazardous locations.
- The AEx nA nR factory sealed Mercmaster III prevents vapors and gases from entering the globe chamber. There are no seals or putty required which will reduce installation time and installation errors.



Low Profile Mercmaster III with Prismatic Globe and Guard

Standard Materials

- Mounting hoods, bodies and guard: cast copperfree (4/10 of 1% max.) aluminum
- All hardware and catch assemblies: stainless steel
- Reflectors: Fiberglass reinforced white polyester
- Globes and Refractors: heat-resistant prismatic glass

Standard Finishes

- Mounting hoods, bodies and guards: baked gray epoxy-clad finish, electrostatically applied for complete uniform protection

Options

- Quartz Auxiliary comes to full brightness immediately and remains lit until the HID lamp attains 60-70% of full illumination. Quartz Auxiliary supplied with relay switch and socket to accept 120 V quartz double-contact bayonet base lamp (not included). Add suffix **-E** ①.
- Guards with gray epoxy painted to match fixtures, supplied with stainless steel screws. Add suffix **-G** before voltage suffix.
- Hot Restrike to restrike HPS lamp immediately when power is restored after a momentary power interruption. Add suffix **-R**.
- Smart Starter incorporates a 1-1/2 minute timer and performs as a conventional starter to normally start lamp. Removes itself from circuit if lamp burns out or is removed from socket. Eliminates starter failures caused by prolonged operation with cycling or failing lamps and simplifies finding their location, reducing maintenance and repair costs. Available for all fixtures. Add suffix **-S**.
- AEx nA nR fixtures, add suffix **-Z2**.
- AEx nR fixtures, add suffix **-ZB**.
- Reflectors are available as standard dome and 30° angle polyester. Order separately.

NEC/CEC Certifications and Compliances ②

- cULus Listed: E10444
- UL Standard: ANSI/UL 844, 1598, 60079-0, 60079-15, Marine Type Electric Fixtures Outside Type (Salt Water)
- CSA Certified: 025428
- CSA Standard: CSA C22.2 No. 9, C22.2 No. 137; CAN/CSA E60079-0, E60079-15

Related Products

- Photocells for classified use are available, see *PCD2 Series*.

① Fixtures equipped with quartz auxiliary lamp do not comply with NEC/CEC requirements and are not suitable for use in classified locations.

② Compliance data varies for specific fixtures. Consult Appleton regarding suitability of specific fixtures for a particular application.

Mercmaster™ III Low Profile Luminaires

High Pressure Sodium and Pulse Start Metal Halide

Listed for simultaneous exposure to combustible dusts and flammable gases or vapors.

NEC/CEC:
 Class I, Division 2, Groups A, B, C, D
 Class I, Zone 2, AEx nA nR IIC (Z2)
 Class I, Zone 2, AEx nR IIC (ZB)
 Class II, Division 1 and 2, Groups E, F, G
 Class III

NEC/CEC:
 Simultaneous Exposure
 (Class I, Division 2/Class II, Division 1)
 Fixtures Outside Type (Salt Water)
 Type 4X
 IP66

Illustrated Features



High Temperature Sockets
 Medium base high-temperature porcelain sockets.

Aluminum Inner Reflector
 Solid aluminum inner reflector (for refractor ballast housings only) improves photometric efficiency.

Globe Chamber
 Completely sealed from the ballast housing and outside vapors/air (nR).

Electrical Protection
 Ground wire provided to bond mounting hood to ballast housing.

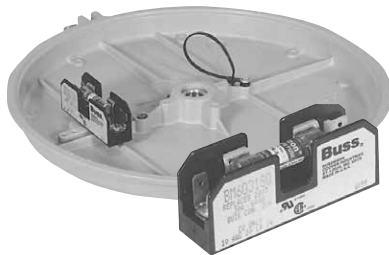

Fuses
 Two screws secure fuse kit to mounting boss in any Mercmaster mounting hood. Fuse included.

Photocell
 Available for all fixtures except cone and ceiling mount. Installs through knock-out in mounting hood. Provides continuous ON-OFF dusk-to-dawn control.



Vented Reflectors
 Reflectors are thick, tough fiberglass-reinforced white polyester, vented for cooler operation. Quickly attach with furnished stainless steel screws.

Stainless Steel Inserts
 Ballast bodies have stainless steel threaded inserts to receive stainless steel screws for reflectors and guard. Prevents "freezing", allowing guards and reflectors to be easily removed and replaced at any time, without damage to the housing.

Epoxy Finish
 Ballast housing, hoods and guards are copperfree aluminum with epoxy powder coat finish.

Prismatic Glass Globes and Refractors
 Heat-resistant globes and refractors thread directly into ballast housing and seal against a high-temperature silicone rubber gasket.



"Safety" High Hinge
 Extra-high hinge provides additional protection against accidental ballast housing disengagement during installation or maintenance.



Ballast Assembly
 Utilizing non-sparking components avoiding the ignition of gases or vapors that may be present (nA).

Mounting Hood and Globe Gaskets
 Silicone rubber gaskets seals out moisture, dirt and dust. Stays flexible, withstands high temperatures. Closure design assures uniform gasket compression.

Terminal Blocks (Zone 2)
 A seven-point terminal block is provided to facilitate wiring. Terminal block accommodates wire size ranging from #8 to #24 AWG.



Cooler Operating Cone Hood
 Larger sloped surface sheds dusts, dirt and combustible fibers providing better heat dissipation.



Stainless Steel Latch Assembly
 Captive, stainless steel latch assembly bolt and nut closes securely, resists attack of corrosive atmospheres. Swing-away design simplifies servicing.

Mercmaster™ III Low Profile Luminaires

High Pressure Sodium and Pulse Start Metal Halide

Listed for simultaneous exposure to combustible dusts and flammable gases or vapors.

NEC/CEC:

Class I, Division 2, Groups A, B, C, D
 Class I, Zone 2, AEx nA nR IIC (Z2)
 Class I, Zone 2, AEx nR IIC (ZB)
 Class II, Division 1 and 2, Groups E, F, G
 Class III

NEC/CEC:

Simultaneous Exposure
 (Class I, Division 2/Class II, Division 1)
 Fixtures Outside Type (Salt Water)
 Type 4X
 IP66

Mercmaster III Low Profile Family Tree

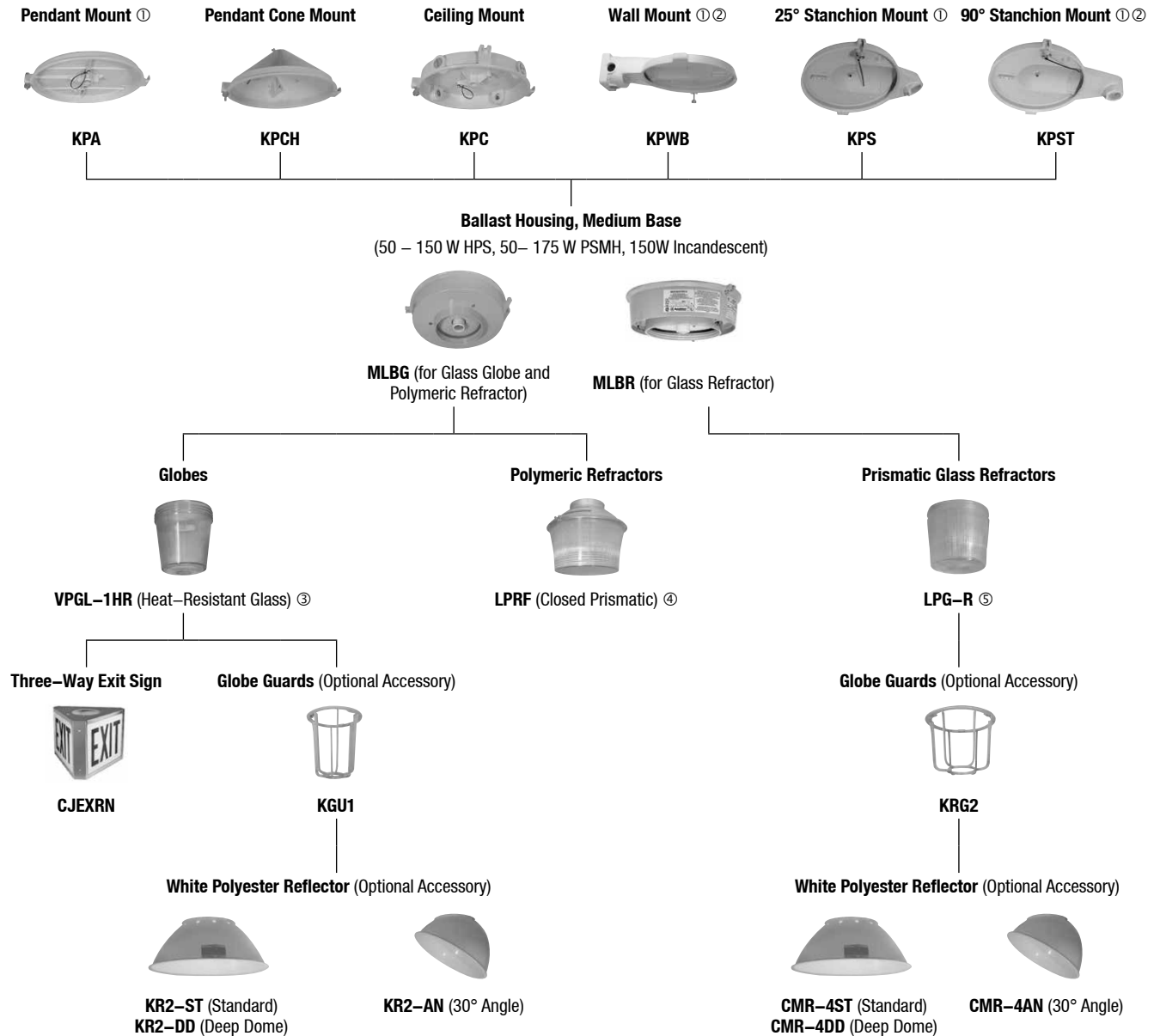

① Mounting hood with a 120 V or 208-277 V factory installed photocell is available.

② Standard and deep dome reflectors may interfere with bottom conduit entry if used with KPST and KPWB mounting hoods..

③ Available in clear, amber, blue, green and red.

④ Available in NEMA Type II, III, IV and V. Polymeric Refractor suitable for Class II, Groups F and G, NEMA 4X and Marine Type Electric Fixtures Outside Type (Salt Water) only (100 W PSMH Max.).

⑤ Available in NEMA Type I, III and V.

Mercmaster™ III Low Profile Luminaires

High Pressure Sodium and Pulse Start Metal Halide

Listed for simultaneous exposure to combustible dusts and flammable gases or vapors.

NEC/CEC:

Class I, Division 2, Groups A, B, C, D
 Class I, Zone 2, AEx nA nR IIC (Z2)
 Class I, Zone 2, AEx nR IIC (ZB)
 Class II, Division 1 and 2, Groups E, F, G
 Class III

NEC/CEC:

Simultaneous Exposure
 (Class I, Division 2/Class II, Division 1)
 Fixtures Outside Type (Salt Water)
 Type 4X
 IP66

Order using catalog numbering guide below or select catalog number from tables on following pages.

Catalog Numbering Guide

<p>ML</p> <p>Series: ML - Mercmaster III Low Profile</p>	<p>A</p> <p>Mounting: A - Pendant (rigid mounting) C - Ceiling D - Pendant Cone Hood F - Pendant (flexible mounting) R - 90° Stanchion S - 25° Stanchion W - Wall</p>	<p>L</p> <p>Lamp Type: I - Incandescent L - High Pressure Sodium P - Pulse Start Metal Halide</p>	<p>15</p> <p>Wattage: 10 - 100 W HPS, PSMH 15 - 150 W HPS, PSMH and 60-150 W max. Incandescent 17 - 175 W PSMH 50 - 50 W HPS, PSMH 70 - 70 W HPS, PSMH</p>	<p>2</p> <p>Hub Size: 2 - 3/4" NPT 3 - 1" NPT 4 - 1-1/4" NPT stanchion 5 - 1-1/2" NPT stanchion</p>	<p>G1</p> <p>Optical Assembly: ② G1 - Globe J1 - NEMA I Glass Refractor J3 - NEMA III Glass Refractor J5 - NEMA V Glass Refractor P2 - NEMA II Polymeric Refractor P3 - NEMA III Polymeric Refractor P4 - NEMA IV Polymeric Refractor P5 - NEMA V Polymeric Refractor</p>	<p>G</p> <p>Guard Options: G - Cast Guard N - No Guard</p>	<p>MT</p> <p>Voltage: ① LB - Incandescent, 120, 60 Hz MT - 120/208/240/277, 60 Hz 5MT - 120/208/240/ 277/480, 60 Hz 48 - 480, 60 Hz 125 - 120, 50 Hz 225 - 225, 50 Hz 226 - 220, 60 Hz 236 - 230, 60 Hz 245 - 240, 50 Hz 246 - 240, 60 Hz</p>	<p>R</p> <p>Options: E - Emergency Quartz ③ F - Fuse Kit (Specify Voltage) R - Hot Restrike ③ S - Smart Starter ④ H1 - Photocontrol 120 V H2 - Photocontrol 208 V H3 - Photocontrol 240 V H4 - Photocontrol 277 V D - E-27 Export Socket</p> <p>Optional Fusing ⑥ FN - 120 V FP - 208 V FS - 240 V FT - 277 V FF - 480 V</p>	<p>Z2</p> <p>Suffix: Z2 - Zone 2 suffix (required for AEx nA nR rating) ZB - Zone 2 suffix (required for AEx nR)</p>
---	--	--	---	--	--	---	--	---	---

① Other voltages, frequencies available – contact your local sales representative. Voltages shown are limited to specific combinations; refer to following pages.
 ② Polymeric Refractor suitable for Class II, Groups F and G, NEMA 4X and Marine Type Electric Fixtures Outside Type (Salt Water) only (100 W PSMH Max.).
 Refractors ordered separately.
 ③ Available for 50-150 W HPS fixtures only.
 ④ Available for HPS or PSMH fixtures.
 ⑤ Fixtures equipped with quartz auxiliary lamp do not comply with NEC/CEC requirements and are not suitable for use in classified locations
 ⑥ Optional fusing is available for use with MT, 5MT and 48 voltage suffixes ONLY.

 HID/AREA: NEC/CEC ENCLOSED AND GASKETED

Mercmaster™ III Low Profile Luminaires

Class I, Division 2; Class II, Division 1; Simultaneous exposure to hazardous conditions in both classifications

Temperature identification numbers of Mercmaster III Low Profile High Pressure Sodium and Pulse Start Metal Halide

NEC/CEC:
 Class I, Division 2, Groups A, B, C, D
 Class I, Zone 2, AEx nA nR IIC (Z2)
 Class I, Zone 2, AEx nR IIC (ZB)
 Class II, Division 1 and 2, Groups E, F, G
 Class III

NEC/CEC:
 Simultaneous Exposure
 (Class I, Division 2/Class II, Division 1)
 Fixtures Outside Type (Salt Water)
 Type 4X
 IP66

Lamp		Supply Wire Min.	Ambient Temp.	Class I, Division 2			Class II, Division 1 Groups E, F and G			Simultaneous Exposure Class I, Division 2 / Class II, Division 1		
Watts	Type	Temp. °C (°F)	°C (°F)	Globe	Reflector	Refractor	Globe	Reflector	Refractor	Globe	Reflector	Refractor
50	HPS	90 °C (194 °F)	40 °C (104 °F)	T3	T3	T3B	T4A	T4A	T5	T3	T3	T3
		90 °C (194 °F)	55 °C (131 °F)	T3	T3	T3A	T4A	T4A	T4A	T2D	T2D	T2D
		90 °C (194 °F)	65 °C (149 °F)	T3	T3	T3A	T4	T4	T4A	T2C	T2C	T2C
70	HPS	90 °C (194 °F)	40 °C (104 °F)	T3	T3	T3	T4	T4	T5	T2B	T2B	T2D
		90 °C (194 °F)	55 °C (131 °F)	T2D	T2D	T3	T3C	T3C	T4A	T2B	T2B	T2C
		90 °C (194 °F)	65 °C (149 °F)	—	—	T3	—	—	T4	—	—	T2B
100	HPS	90 °C (194 °F)	40 °C (104 °F)	T2C	T2C	T2D	T4	T4	T4A	T2B	T2B	T2B
		90 °C (194 °F)	55 °C (131 °F)	T2B	T2B	T2C	T3C	T3C	T4	T2A	T2A	T2A
		90 °C (194 °F)	65 °C (149 °F)	—	—	—	—	—	—	—	—	—
150	HPS	90 °C (194 °F)	40 °C (104 °F)	T2A	T2A	T2B	T3A ①	—	T4	325	—	T2
		90 °C (194 °F)	40 °C (104 °F)	T3	T3	T3A	T4A	T4A	T6	T2D	T2D	T3
		90 °C (194 °F)	55 °C (131 °F)	T3	T3	T3	T4	T4	T5	T2C	T2C	T2D
50	PSMH	90 °C (194 °F)	65 °C (149 °F)	T3	T3	T3	T4	T4	T4A	T2B	T2B	T2D
		90 °C (194 °F)	40 °C (104 °F)	T3	T3	T3	T3C	T3C	T4A	T2B	T2B	T2C
		90 °C (194 °F)	55 °C (131 °F)	T2D	T2D	T3	T3C	T3C	T4A	T2A	T2A	T2B
70	PSMH	110 °C (230 °F)	65 °C (149 °F)	—	—	T3	—	—	T4	—	—	T2B
		90 °C (194 °F)	40 °C (104 °F)	T2A	T2A	T2B	T3B	T3B	T4A	T2	T2	T2A
		90 °C (194 °F)	55 °C (131 °F)	T2A	T2A	T2B	T3A ①	T3A ①	T4	T1	T1	T2
150	PSMH	105 °C (221 °F)	40 °C (104 °F)	350	350	325	—	—	T3B	—	—	T1
175	PSMH	105 °C (221 °F)	40 °C (104 °F)	350	350	325	—	—	T3B	—	—	T1
60	Inc.	90 °C (194 °F)	40 °C (104 °F)	T3B	T3B	T3C	—	—	—	—	—	—
		90 °C (194 °F)	55 °C (131 °F)	T3A	T3A	T3C	—	—	—	—	—	—
		90 °C (194 °F)	65 °C (149 °F)	T3A	T3A	T3C	—	—	—	—	—	—
100	Inc.	90 °C (194 °F)	40 °C (104 °F)	T3	T3	T3	—	—	—	—	—	—
		90 °C (194 °F)	55 °C (131 °F)	T3	T3	T3	—	—	—	—	—	—
		90 °C (194 °F)	65 °C (149 °F)	T2D	T2D	T3	—	—	—	—	—	—
150	Inc.	90 °C (194 °F)	40 °C (104 °F)	T2D	T2D	T3	—	—	—	—	—	—
		90 °C (194 °F)	55 °C (131 °F)	T2B	T2B	T2D	—	—	—	—	—	—
		90 °C (194 °F)	65 °C (149 °F)	T2B	T2B	T2D	—	—	—	—	—	—

“T” Numbers Represent the Maximum Lamp Temperature for Class I, Division 2 Locations and Maximum Surface Temperature Under Dust Blanket for Class II, Division 1 Locations.

“T” #	T1	350	325	T2	T2A	T2B	T2C	T2D	T3	T3A	T3B	T3C	T4	T4A	T5	T6
Temp. Range (°C)	351-450	326-350	301-325	281-300	261-280	231-260	216-230	201-215	181-200	166-180	161-165	136-160	121-135	101-120	86-100	85
Temp. Range (°F)	664-842	619-662	574-617	538-572	502-536	448-500	421-446	394-419	358-392	331-356	322-329	277-320	250-275	214-248	187-212	185

① “T” numbers are for Groups E and F only.

Mercmaster™ III Low Profile Luminaires

Class I, Zone 2, AEx nA nR IIC, AEx nR IIC IP66, NEMA 4X

Temperature identification numbers of Mercmaster III Zone 2 Low Profile High Pressure Sodium and Pulse Start Metal Halide.

NEC/CEC:

Class I, Division 2, Groups A, B, C, D
 Class I, Zone 2, AEx nA nR IIC (Z2)
 Class I, Zone 2, AEx nR IIC (ZB)
 Class II, Division 1 and 2, Groups E, F, G
 Class III

NEC/CEC:

Simultaneous Exposure
 (Class I, Division 2/Class II, Division 1)
 Fixtures Outside Type (Salt Water)
 Type 4X
 IP66

Lamp				Class I, Zone 2 AEx nA nR IIC			Class I, Zone 2 AEx nR IIC		
Watts	Type	Supply Wire Temp. °C (°F)	Ambient Temp. °C (°F)	Globe	Globe w/ Reflector	Reflector	Globe	Globe w/ Reflector	Reflector
50	HPS	90 °C (194 °F)	40 °C (104 °F)	T6	T6	T6	T6	T6	T6
		90 °C (194 °F)	55 °C (131 °F)	T5	T5	T5	T5	T5	T5
		90 °C (194 °F)	65 °C (149 °F)	T4	T4	T5	T4	T4	T5
70	HPS	90 °C (194 °F)	40 °C (104 °F)	T5	T5	T5	T5	T5	T5
		90 °C (194 °F)	55 °C (131 °F)	T4	T4	T4	T4	T4	T4
		90 °C (194 °F)	65 °C (149 °F)	—	—	T4	—	—	T4
100	HPS	90 °C (194 °F)	40 °C (104 °F)	T4	T4	T4	T4	T4	T4
		90 °C (194 °F)	55 °C (131 °F)	T4	T4	T4	T4	T4	T4
150	HPS	90 °C (194 °F)	40 °C (104 °F)	T4	T4	T4	T4	T4	T4
50	PSMH	90 °C (194 °F)	40 °C (104 °F)	T5	T5	T6	T5	T5	T6
		90 °C (194 °F)	55 °C (131 °F)	T5	T5	T6	T5	T5	T6
		90 °C (194 °F)	65 °C (149 °F)	T4	T4	T5	T4	T4	T5
70	PSMH	90 °C (194 °F)	40 °C (104 °F)	T5	T5	T6	T5	T5	T6
		90 °C (194 °F)	55 °C (131 °F)	T4	T4	T6	T4	T4	T6
		110 °C (230 °F)	65 °C (149 °F)	—	—	T4	—	—	T4
100	PSMH	90 °C (194 °F)	40 °C (104 °F)	T4	T4	T6	T4	T4	T6
		90 °C (194 °F)	55 °C (131 °F)	T4	T4	T4	T4	T4	T4
150	PSMH	105 °C (221 °F)	40 °C (104 °F)	T3	T3	T4	T3	T3	T4
175	PSMH	105 °C (221 °F)	40 °C (104 °F)	T3	T3	T4	T3	T3	T4

“T” Numbers represent the maximum surface temperature for luminaires with AEx nA nR and AEx nR rating:

The “T” number is established by separately determining the maximum temperature of the globe surface and ballast compartment. The hotter of the two is taken to determine the “T” number for the overall fixture.

“T” Number	T1	T2	T3	T4	T5	T6
Temp. Range (°C)	301-450	201-300	136-200	101-135	86-100	85
Temp. Range (°F)	547-842	394-572	277-392	214-275	187-212	185



Mercmaster™ III Low Profile Luminaires

50 W – 150 W HPS

High Power Factor (min. P.F. 90%). Medium base lamps.

NEC/CEC:
 Class I, Division 2, Groups A, B, C, D
 Class I, Zone 2, AEx nA nR IIC (Z2)
 Class I, Zone 2, AEx nR IIC (ZB)
 Class II, Division 1 and 2, Groups E, F, G
 Class III

NEC/CEC:
 Simultaneous Exposure
 (Class I, Division 2/Class II, Division 1)
 Fixtures Outside Type (Salt Water)
 Type 4X
 IP66

	Lamp Type	Lamp Watts	Hub Size (Inches)	Catalog Numbers ③④⑤	
				With Globe	With Type V 8" Refractor ②
Pendant – One Hub, Rigid Mounting ①					
	HPS	50	3/4	MLAL502G1N	MLAL502J5N
			1	MLAL503G1N	MLAL503J5N
	HPS	70	3/4	MLAL702G1N	MLAL702J5N
			1	MLAL703G1N	MLAL703J5N
	HPS	100	3/4	MLAL102G1N	MLAL102J5N
		1	MLAL103G1N	MLAL103J5N	
Shown with Globe and Optional Guard	HPS	150	3/4	MLAL152G1N ⑥	MLAL152J5N ⑥
			1	MLAL153G1N ⑥	MLAL153J5N ⑥
Pendant Cone – One Hub, Rigid Mounting					
	HPS	50	3/4	MLDL502G1N	MLDL502J5N
			1	MLDL503G1N	MLDL503J5N
	HPS	70	3/4	MLDL702G1N	MLDL702J5N
			1	MLDL703G1N	MLDL703J5N
	HPS	100	3/4	MLDL102G1N	MLDL102J5N
		1	MLDL103G1N	MLDL103J5N	
Shown with Refractor	HPS	150	3/4	MLDL152G1N ⑥	MLDL152J5N ⑥
			1	MLDL153G1N ⑥	MLDL153J5N ⑥
Ceiling – Five Hubs, Four Close-up Plugs					
	HPS	50	3/4	MLCL502G1N	MLCL502J5N
			1	MLCL503G1N	MLCL503J5N
	HPS	70	3/4	MLCL702G1N	MLCL702J5N
			1	MLCL703G1N	MLCL703J5N
	HPS	100	3/4	MLCL102G1N	MLCL102J5N
		1	MLCL103G1N	MLCL103J5N	
Shown with Globe	HPS	150	3/4	MLCL152G1N ⑥	MLCL152J5N ⑥
			1	MLCL153G1N ⑥	MLCL153J5N ⑥

① For Flexible Pendant Mount, change **A** to **F** in catalog number (except 50 W HPS).

② To order fixture with NEMA Type I or NEMA Type III refractor, change final digit **5** in catalog number to **1** or **3**.

③ For fixtures with guards, substitute a **G** for the **N** before adding voltage suffix. See following pages for accessory ordering information.

④ Add the following voltage and frequency designation before **Z2** suffix:

Lamp Type	Lamp Watts	LB	MT	5MT	48	125	Voltage Suffixes					
							225	226	235	236	245	246
Inc.	150 Max.	X	—	—	—	—	—	—	—	—	—	—
HPS	50	—	X	—	—	—	X	X	—	X	X	X
HPS	70	—	X	—	X	X	X	X	—	X	X	X
HPS	100	—	X	—	X	X	X	X	—	X	X	X
HPS	150	—	X	—	X	X	X	X	—	—	X	—
PSMH	50	—	X	—	X	—	—	—	—	—	—	—
PSMH	70	—	X	—	X	X	X	—	—	—	X	—
PSMH	100	—	X	—	X	X	X	—	—	—	X	—
PSMH	150	—	X	—	X	—	—	—	—	—	X	—
PSMH	175	—	X	X	X	—	—	—	—	—	X	—

Voltages:

LB - Incandescent, 120 V 60 Hz

48 - 480 V 60 Hz

226 - 220 V 60 Hz

MT - 120/208/240/277 V 60 Hz

125 - 120 V 50 Hz

235 - 230 V 50 Hz

245 - 240 V 50 Hz

5MT - 120/208/240/277/480 V 60 Hz

225 - 225 V 50 Hz

236 - 230 V 60 Hz

246 - 240 V 60 Hz

⑤ Add **Z2** suffix for factory sealed non-sparking/restricted breathing protection (AEx nA nR). Add **ZB** suffix for restricted breathing protection (AEx nR).

⑥ For 150 W HPS fixtures, use S-55 lamp type only.

Mercmaster™ III Low Profile Luminaires

50 W – 150 W HPS



High Power Factor (min. P.F. 90%). Medium base lamps.

NEC/CEC:

Class I, Division 2, Groups A, B, C, D
 Class I, Zone 2, AEx nA nR IIC (Z2)
 Class I, Zone 2, AEx nR IIC (ZB)
 Class II, Division 1 and 2, Groups E, F, G
 Class III

NEC/CEC:

Simultaneous Exposure
 (Class I, Division 2/Class II, Division 1)
 Fixtures Outside Type (Salt Water)
 Type 4X
 IP66

	Lamp Type	Lamp Watts	Hub Size (Inches)	Catalog Numbers ③④⑤		
				With Globe	With Type V 8" Refractor ②	
Wall – Five Hubs, Four Close-Up Plugs						
	HPS	50	3/4 1	MLWL502G1N MLWL503G1N	MLWL502J5N MLWL503J5N	
	HPS	70	3/4 1	MLWL702G1N MLWL703G1N	MLWL702J5N MLWL703J5N	
	HPS	100	3/4 1	MLWL102G1N MLWL103G1N	MLWL102J5N MLWL103J5N	
	HPS	150	3/4 1	MLWL152G1N ⑥ MLWL153G1N ⑥	MLWL152J5N ⑥ MLWL153J5N ⑥	
	Shown with Refractor and Optional Guard					
	25° Stanchion – One Hub					
		HPS	50	1-1/4 1-1/2	MLSL504G1N MLSL505G1N	MLSL504J5N MLSL505J5N
		HPS	70	1-1/4 1-1/2	MLSL704G1N MLSL705G1N	MLSL704J5N MLSL705J5N
HPS		100	1-1/4 1-1/2	MLSL104G1N MLSL105G1N	MLSL104J5N MLSL105J5N	
HPS		150	1-1/4 1-1/2	MLSL154G1N ⑥ MLSL155G1N ⑥	MLSL154J5N ⑥ MLSL155J5N ⑥	
Shown with Globe and Optional Guard						
90° Stanchion – One Hub						
		HPS	50	1-1/4 1-1/2	MLRL504G1N MLRL505G1N	MLRL504J5N MLRL505J5N
		HPS	70	1-1/4 1-1/2	MLRL704G1N MLRL705G1N	MLRL704J5N MLRL705J5N
	HPS	100	1-1/4 1-1/2	MLRL104G1N MLRL105G1N	MLRL104J5N MLRL105J5N	
	HPS	150	1-1/4 1-1/2	MLRL154G1N ⑥ MLRL155G1N ⑥	MLRL154J5N ⑥ MLRL155J5N ⑥	
	Shown with Refractor and Optional Guard					

② To order fixture with NEMA Type I or NEMA Type III refractor, change final digit 5 in catalog number to 1 or 3.

③ For fixtures with guards, substitute a G for the N before adding voltage suffix. See following pages for accessory ordering information.

④ Add the following voltage and frequency designation before Z2 suffix:

Lamp Type	Lamp Watts	Voltage Suffixes										
		LB	MT	5MT	48	125	225	226	235	236	245	246
Inc.	150 Max.	X	—	—	—	—	—	—	—	—	—	—
HPS	50	—	X	—	—	—	X	X	—	X	X	X
HPS	70	—	X	—	X	X	X	X	—	X	X	X
HPS	100	—	X	—	X	X	X	X	—	X	X	X
HPS	150	—	X	—	X	X	X	X	—	—	X	—
PSMH	50	—	X	—	X	—	—	—	—	—	—	—
PSMH	70	—	X	—	X	X	X	—	—	—	X	—
PSMH	100	—	X	—	X	X	X	—	—	—	X	—
PSMH	150	—	X	—	X	—	—	—	—	—	X	—
PSMH	175	—	X	X	X	—	—	—	—	—	X	—

Voltages:

LB - Incandescent, 120 V 60 Hz

48 - 480 V 60 Hz

226 - 220 V 60 Hz

MT - 120/208/240/277 V 60 Hz

125 - 120 V 50 Hz

235 - 230 V 50 Hz

5MT - 120/208/240/277/480 V 60 Hz

225 - 225 V 50 Hz

236 - 230 V 60 Hz

245 - 240 V 50 Hz

246 - 240 V 60 Hz

⑤ Add Z2 suffix for factory sealed non-sparking/restricted breathing protection (AEx nA nR). Add ZB suffix for restricted breathing protection (AEx nR).

⑥ For 150 W HPS fixtures, use S-55 lamp type only.

Mercmaster™ III Low Profile Luminaires

50 W - 175 W PSMH



High Power Factor (min. P.F. 90%). Medium base lamps.

NEC/CEC:

Class I, Division 2, Groups A, B, C, D
 Class I, Zone 2, AEx nA nR IIC (Z2)
 Class I, Zone 2, AEx nR IIC (ZB)
 Class II, Division 1 and 2, Groups E, F, G
 Class III

NEC/CEC:

Simultaneous Exposure
 (Class I, Division 2/Class II, Division 1)
 Fixtures Outside Type (Salt Water)
 Type 4X
 IP66

	Lamp Type	Lamp Watts	Hub Size (Inches)	Catalog Numbers ③④⑤	
				With Globe	With Type V 8" Refractor ②
Pendant — One Hub, Rigid Mounting ①					
	PSMH	50	3/4 1	MLAH502G1N MLAH503G1N	MLAH502J5N MLAH503J5N
	PSMH	70	3/4 1	MLAH702G1N MLAH703G1N	MLAH702J5N MLAH703J5N
	PSMH	100	3/4 1	MLAH102G1N MLAH103G1N	MLAH102J5N MLAH103J5N
	PSMH	150	3/4 1	MLAP152G1N MLAP153G1N	MLAP152J5N MLAP153J5N
	PSMH	175	3/4 1	MLAP172G1N MLAP173G1N	MLAP172J5N MLAP173J5N
	Shown with Globe and Optional Guard				
Pendant Cone — One Hub, Rigid Mounting					
	PSMH	50	3/4 1	MLDH502G1N MLDH503G1N	MLDH502J5N MLDH503J5N
	PSMH	70	3/4 1	MLDH702G1N MLDH703G1N	MLDH702J5N MLDH703J5N
	PSMH	100	3/4 1	MLDH102G1N MLDH103G1N	MLDH102J5N MLDH103J5N
	PSMH	150	3/4 1	MLDP152G1N MLDP153G1N	MLDP152J5N MLDP153J5N
	PSMH	175	3/4 1	MLDP172G1N MLDP173G1N	MLDP172J5N MLDP173J5N
	Shown with Refractor				
Ceiling — Five Hubs, Four Close-up Plugs					
	PSMH	50	3/4 1	MLCH502G1N MLCH503G1N	MLCH502J5N MLCH503J5N
	PSMH	70	3/4 1	MLCH702G1N MLCH703G1N	MLCH702J5N MLCH703J5N
	PSMH	100	3/4 1	MLCH102G1N MLCH103G1N	MLCH102J5N MLCH103J5N
	PSMH	150	3/4 1	MLCP152G1N MLCP153G1N	MLCP152J5N MLCP153J5N
	PSMH	175	3/4 1	MLCP172G1N MLCP173G1N	MLCP172J5N MLCP173J5N
	Shown with Globe				

- ① For Flexible Pendant Mount, change **A** to **F** in catalog number (except 50 W HPS).
- ② To order fixture with NEMA Type I or NEMA Type III refractor, change final digit **5** in catalog number to **1** or **3**.
- ③ For fixtures with guards, substitute a **G** for the **N** before adding voltage suffix. See following pages for accessory ordering information.
- ④ Add the following voltage and frequency designation before **Z2** suffix:

Lamp Type	Lamp Watts	Voltage Suffixes											
		LB	MT	5MT	48	125	225	226	235	236	245	246	
Inc.	150 Max.	X	—	—	—	—	—	—	—	—	—	—	—
HPS	50	—	X	—	—	—	X	X	—	X	X	X	X
HPS	70	—	X	—	X	X	X	X	—	X	X	X	X
HPS	100	—	X	—	X	X	X	X	—	X	X	X	X
HPS	150	—	X	—	X	X	X	X	—	—	X	—	—
PSMH	50	—	X	—	X	—	—	—	—	—	—	—	—
PSMH	70	—	X	—	X	X	X	—	—	—	X	—	—
PSMH	100	—	X	—	X	X	X	—	—	—	X	—	—
PSMH	150	—	X	—	X	—	—	—	—	—	—	X	—
PSMH	175	—	X	X	X	—	—	—	—	—	X	—	—

Voltages:
LB - Incandescent, 120 V 60 Hz **48** - 480 V 60 Hz **226** - 220 V 60 Hz
MT - 120/208/240/277 V 60 Hz **125** - 120 V 50 Hz **235** - 230 V 50 Hz **245** - 240 V 50 Hz
5MT - 120/208/240/277/480 V 60 Hz **225** - 225 V 50 Hz **236** - 230 V 60 Hz **246** - 240 V 60 Hz

⑤ Add **Z2** suffix for factory sealed non-sparking/restricted breathing protection (AEx nA nR). Add **ZB** suffix for restricted breathing protection (AEx nR).

Mercmaster™ III Low Profile Luminaires

50 W - 175 W PSMH



High Power Factor (min. P.F. 90%). Medium base lamps.

NEC/CEC:

Class I, Division 2, Groups A, B, C, D
 Class I, Zone 2, AEx nA nR IIC (Z2)
 Class I, Zone 2, AEx nR IIC (ZB)
 Class II, Division 1 and 2, Groups E, F, G
 Class III

NEC/CEC:

Simultaneous Exposure
 (Class I, Division 2/Class II, Division 1)
 Fixtures Outside Type (Salt Water)
 Type 4X
 IP66

	Lamp Type	Lamp Watts	Hub Size (Inches)	Catalog Numbers ③④⑤	
				With Globe	With Type V 8" Refractor ②
Wall — Five Hubs, Four Close-Up Plugs					
	PSMH	50	3/4 1	MLWH502G1N MLWH503G1N	MLWH502J5N MLWH503J5N
	PSMH	70	3/4 1	MLWH702G1N MLWH703G1N	MLWH702J5N MLWH703J5N
	PSMH	100	3/4 1	MLWH102G1N MLWH103G1N	MLWH102J5N MLWH103J5N
	PSMH	150	3/4 1	MLWP152G1N MLWP153G1N	MLWP152J5N MLWP153J5N
	PSMH	175	3/4 1	MLWP172G1N MLWP173G1N	MLWP172J5N MLWP173J5N
25° Stanchion — One Hub					
	PSMH	50	1-1/4 1-1/2	MLSH504G1N MLSH505G1N	MLSH504J5N MLSH505J5N
	PSMH	70	1-1/4 1-1/2	MLSH704G1N MLSH705G1N	MLSH704J5N MLSH705J5N
	PSMH	100	1-1/4 1-1/2	MLSH104G1N MLSH105G1N	MLSH104J5N MLSH105J5N
	PSMH	150	1-1/4 1-1/2	MLSP154G1N MLSP155G1N	MLSP154J5N MLSP155J5N
	PSMH	175	1-1/4 1-1/2	MLSP174G1N MLSP175G1N	MLSP174J5N MLSP175J5N
90° Stanchion — One Hub					
	PSMH	50	1-1/4 1-1/2	MLRH504G1N MLRH505G1N	MLRH504J5N MLRH505J5N
	PSMH	70	1-1/4 1-1/2	MLRH704G1N MLRH705G1N	MLRH704J5N MLRH705J5N
	PSMH	100	1-1/4 1-1/2	MLRH104G1N MLRH105G1N	MLRH104J5N MLRH105J5N
	PSMH	150	1-1/4 1-1/2	MLRP154G1N MLRP155G1N	MLRP154J5N MLRP155J5N
	PSMH	175	1-1/4 1-1/2	MLRP174G1N MLRP175G1N	MLRP174J5N MLRP175J5N

② To order fixture with NEMA Type I or NEMA Type III refractor, change final digit 5 in catalog number to 1 or 3.

③ For fixtures with guards, substitute a G for the N before adding voltage suffix. See following pages for accessory ordering information.

④ Add the following voltage and frequency designation before Z2 suffix:

Lamp Type	Lamp Watts	Voltage Suffixes										
		LB	MT	5MT	48	125	225	226	235	236	245	246
Inc.	150 Max.	X	—	—	—	—	—	—	—	—	—	—
HPS	50	—	X	—	—	—	X	X	—	X	X	X
HPS	70	—	X	—	X	X	X	X	—	X	X	X
HPS	100	—	X	—	X	X	X	X	—	X	X	X
HPS	150	—	X	—	X	X	X	X	—	X	X	X
PSMH	50	—	X	—	X	—	—	—	—	—	—	—
PSMH	70	—	X	—	X	X	X	—	—	—	X	—
PSMH	100	—	X	—	X	X	X	—	—	—	X	—
PSMH	150	—	X	—	X	—	—	—	—	—	X	—
PSMH	175	—	X	X	X	—	—	—	—	—	X	—

Voltages:

LB - Incandescent, 120 V 60 Hz

MT - 120/208/240/277 V 60 Hz

5MT - 120/208/240/277/480 V 60 Hz

48 - 480 V 60 Hz

125 - 120 V 50 Hz

225 - 225 V 50 Hz

226 - 220 V 60 Hz

235 - 230 V 50 Hz

236 - 230 V 60 Hz

245 - 240 V 50 Hz

246 - 240 V 60 Hz

⑤ Add Z2 suffix for factory sealed non-sparking/restricted breathing protection (AEx nA nR). Add ZB suffix for restricted breathing protection (AEx nR).

Mercmaster™ III Low Profile Luminaires







High Pressure Sodium and Pulse Start Metal Halide

Listed for simultaneous exposure to combustible dusts and flammable gases or vapors.

NEC/CEC:
 Class I, Division 2, Groups A, B, C, D
 Class I, Zone 2, AEx nA nR IIC (Z2)
 Class I, Zone 2, AEx nR IIC (ZB)
 Class II, Division 1 and 2, Groups E, F, G
 Class III

NEC/CEC:
 Simultaneous Exposure
 (Class I, Division 2/Class II, Division 1)
 Fixtures Outside Type (Salt Water)
 Type 4X
 IP66

Mounting Hoods

	Description	Hub Size (Inches)	Catalog Number
Pendant			
	One Hub, Rigid Mounting	3/4 1	KPA-75 KPA-100
Pendant – Flexible			
	One Hub, Flexible Mounting	3/4 1	KPAF-75 KPAF-100
Pendant Cone			
	One Hub, Rigid or Flexible Mounting	3/4 1	KPCH-75 KPCH-100
Ceiling			
	Five Hubs, Four Close-Up Plugs	3/4 1	KPC-75 KPC-100
Wall			
	Five Hubs, Four Close-Up Plugs	3/4 1	KPWB-75 KPWB-100
25° Stanchion			
	One Hub	1-1/4 1-1/2	KPS-125 KPS-150
90° Stanchion			
	One Hub	1-1/4 1-1/2	KPST-125 KPST-150

Mercmaster™ III Low Profile Luminaires

High Pressure Sodium and Pulse Start Metal Halide

Listed for simultaneous exposure to combustible dusts and flammable gases or vapors.

NEC/CEC:
 Class I, Division 2, Groups A, B, C, D
 Class I, Zone 2, AEx nA nR IIC (Z2)
 Class I, Zone 2, AEx nR IIC (ZB)
 Class II, Division 1 and 2, Groups E, F, G
 Class III

NEC/CEC:
 Simultaneous Exposure
 (Class I, Division 2/Class II, Division 1)
 Fixtures Outside Type (Salt Water)
 Type 4X
 IP66

Ballast Bodies



Ballast Body for Glass Refractor

High Pressure Sodium
 High Power Factor (Min. P.F. 90%)



Ballast Body for Glass Globe or Polymeric Refractor

Pulse Start Metal Halide
 Super Constant Wattage Autotransformer (Min. P.F. 90%)

Lamp Type	Lamp Watts	Catalog Number ④		Voltage Suffixes												
		For Globe	For Refractor	LB	MT	5MT	48	125	225	226	235	236	245	246		
Inc.	150 Max.	MLBG15I	MLBR15I	X	—	—	—	—	—	—	—	—	—	—	—	—
HPS	50	MLBG50L ①②	MLBR50L ①②	—	X	—	—	—	X	X	X	—	—	X	X	—
HPS	70	MLBG70L ①②	MLBR70L ①②	—	X	—	X	X	X	X	X	—	X	X	X	X
HPS	100	MLBG10L ①②	MLBR10L ①②	—	X	—	X	X	X	X	X	—	X	X	X	X
HPS	150	MLBG15L ①②	MLBR15L ①②	—	X	—	X	X	X	X	X	—	X	X	X	X
PSMH	50	MLBG50H ②③	MLBR50H ②③	—	X	—	X	—	—	—	—	—	—	—	—	—
PSMH	70	MLBG70H ②③	MLBR70H ②③	—	X	—	X	X	X	—	—	—	—	—	X	—
PSMH	100	MLBG10H ②③	MLBR10H ②③	—	X	—	X	X	X	—	—	—	—	—	X	—
PSMH	150	MLBG15P ②③	MLBR15P ②③	—	X	—	X	—	—	—	—	—	—	—	X	—
PSMH	175	MLBG17P ②③	MLBR17P ②③	—	X	X	X	—	—	—	—	—	—	—	X	—

Voltages:

- LB** - Incandescent, 120 V 60 Hz
- MT** - 120/208/240/277 V 60 Hz
- 5MT** - 120/208/240/277/480 V 60 Hz
- 48** - 480 V 60 Hz
- 125** - 120 V 50 Hz
- 225** - 225 V 50 Hz
- 226** - 220 V 60 Hz
- 235** - 230 V 50 Hz
- 236** - 230 V 60 Hz
- 245** - 240 V 50 Hz
- 246** - 240 V 60 Hz

① After voltage suffix add: **-S** for Smart Starter, **-R** for ballast body with Hot Restrike Ignitor.
 ② Add **-E** after voltage suffix for ballast body with provision for Quartz Emergency Light. Not suitable for hazardous locations.
 ③ After voltage suffix add: **-S** for Smart Starter.
 ④ Add **-Z2** suffix for factory sealed non-sparking/restricted breathing protection (AEx nA nR). Add **-ZB** suffix for restricted breathing protection (AEx nR).

Mercmaster™ III Low Profile Luminaires

High Pressure Sodium and Pulse Start Metal Halide

Listed for simultaneous exposure to combustible dusts and flammable gases or vapors.

NEC/CEC:
 Class I, Division 2, Groups A, B, C, D
 Class I, Zone 2, AEx nA nR IIC (Z2)
 Class I, Zone 2, AEx nR IIC (ZB)
 Class II, Division 1 and 2, Groups E, F, G
 Class III

NEC/CEC:
 Simultaneous Exposure
 (Class I, Division 2/Class II, Division 1)
 Fixtures Outside Type (Salt Water)
 Type 4X
 IP66

Accessories and Replacement Parts

		Description	Catalog Number	
Prismatic Glass Globes — Heat-Resistant				
 Glass Globe		Clear	VPGL-1HR	
		Amber	VPGL-1AM	
		Blue	VPGL-1BL	
		Green	VPGL-1GR	
		Red	VPGL-1RE	
		Light Distribution	IES/NEMA Distribution Curves	
Closed Prismatic Glass Refractors — All Heat-Resistant				
 Glass Refractor	NEMA Type I		LPG-R1	
	NEMA Type III		LPG-R3	
	NEMA Type V		LPG-R5	
Closed Prismatic Polymeric Refractors — For Use with PSMH Lamps				
100 W max. +40 °C (+104 °F) max. ambient temperature. Suitable for Class II, Division 1 and 2, Groups F, G; NEMA 4X, UL 1598A Marine Type Electric Fixtures Outside Type (Salt Water)				
 Polymeric Refractor	NEMA Type II		LPRF-2CP	
	NEMA Type III		LPRF-3CP	
	NEMA Type IV		LPRF-4CP	
	NEMA Type V		LPRF-5CP	
		Description	Catalog Number	
White Polyester Reflectors				
 Standard Dome	 30° Angle	For Globe Fixtures	Standard Dome	KR2-ST
			Deep Dome	KR2-DD ①
			30° Angle	KR2-AN
		For Glass Refractor Fixtures	Standard Dome	CMR-4ST ②
			Deep Dome	CMR-4DD ①
			30° Angle	CMR-4AN
Guards				
 Globe Guard	 Refractor Guard	Globe Guard	KGU1	
		Refractor Guard	KRG2	
Replacement Globe Gaskets — Silicone Rubber				
 Globe Gaskets		Globe Gasket	VPGL-GK	
		Refractor Gasket	KRF-GK	

① Dark Skies Compliant.

② Standard and deep dome reflectors may interfere with bottom conduit entry if used with KPST and KPWB mounting hoods.

Mercmaster™ III Low Profile Luminaires

High Pressure Sodium and Pulse Start Metal Halide

Listed for simultaneous exposure to combustible dusts and flammable gases or vapors.

NEC/CEC:
 Class I, Division 2, Groups A, B, C, D
 Class I, Zone 2, AEx nR IIC (Z2)
 Class I, Zone 2, AEx nR IIC (ZB)
 Class II, Division 1 and 2, Groups E, F, G
 Class III

NEC/CEC:
 Simultaneous Exposure
 (Class I, Division 2/Class II, Division 1)
 Fixtures Outside Type (Salt Water)
 Type 4X
 IP66

Electrical Specifications

Line Voltage	Type of Ballast ①	Starting Amps	Operating Amps	Total Watts
50 Watt High Pressure Sodium				
120	HX-HPF	0.58	0.58	64
208	HX-HPF	0.35	0.33	64
240	HX-HPF	0.31	0.29	64
277	HX-HPF	0.25	0.25	64
70 Watt High Pressure Sodium				
120	HX-HPF	0.90	0.82	94
208	HX-HPF	0.50	0.48	94
240	HX-HPF	0.44	0.41	94
277	HX-HPF	0.35	0.36	94
480	HX-HPF	0.21	0.21	94
100 Watt High Pressure Sodium				
120	HX-HPF	1.30	1.15	130
208	HX-HPF	0.76	0.67	130
240	HX-HPF	0.66	0.60	130
277	HX-HPF	0.60	0.52	130
480	HX-HPF	0.33	0.31	135
150 Watt High Pressure Sodium ②				
120	HX-HPF	2.00	1.70	188
208	HX-HPF	1.15	0.95	188
240	HX-HPF	1.00	0.85	188
277	HX-HPF	0.85	0.72	188
480	HX-HPF	0.50	0.47	189
50 Watt Pulse Start Metal Halide				
120	HX-HPF	0.87	0.62	67
208	HX-HPF	0.51	0.40	67
240	HX-HPF	0.47	0.35	67
277	HX-HPF	0.32	0.32	67
70 Watt Pulse Start Metal Halide				
120	HX-HPF	0.80	0.85	95
208	HX-HPF	0.50	0.52	95
240	HX-HPF	0.43	0.44	95
277	HX-HPF	0.39	0.39	95
480	HX-HPF	0.26	0.23	95
100 Watt Pulse Start Metal Halide				
120	HX-HPF	1.20	1.15	130
208	HX-HPF	0.70	0.70	130
240	HX-HPF	0.61	0.58	130
277	HX-HPF	0.55	0.50	130
480	HX-HPF	0.30	0.35	140

Electrical Specifications

Line Voltage	Type of Ballast ①	Starting Amps	Operating Amps	Total Watts
150 Watt Pulse Start Metal Halide				
120	HX-HPF	1.75	1.60	188
208	HX-HPF	1.30	1.00	188
240	HX-HPF	0.85	0.80	188
277	HX-HPF	0.77	0.70	188
480	Super C.W.A.	0.45	0.42	185
175 Watt Pulse Start Metal Halide				
120	Super C.W.A.	0.90	1.78	199
208	Super C.W.A.	0.50	1.08	199
240	Super C.W.A.	0.35	0.89	199
277	Super C.W.A.	0.30	0.76	199
480	Super C.W.A.	0.25	0.50	213

Fuse Kit for Field Installation

Lamp Watts	Volts	Fuse Quantity Required	Fuse Kit Catalog Number HPS	PSMH
50W	120	1	F5	F3
	208	2	F3	F3
	240	2	F3	F2
	277	1	F2	F2
70W	120	1	F5	F4
	208	2	F3	F3
	240	2	F3	F3
	277	1	F2	F2
	480	2	F2	F1
100W	120	1	F8	F6
	208	2	F5	F4
	240	2	F5	F3
	277	1	F3	F3
	480	2	F3	F2
150W	120	1	F10	F10
	208	2	F5	F5
	240	2	F5	F5
	277	1	F5	F4
	480	2	F3	F3
175W	120	1	—	F5
	208	2	—	F3
	240	2	—	F3
	277	1	—	F2
480	2	—	F2	

① C.W.A. – Constant Wattage Autotransformer. HX-HPF – High Reactance High Power Factor Autotransformer. Super C.W.A. – Super Constant Wattage Autotransformer.

② 150 W HPS units equipped with ballasts to operate 55 V lamps only.

Mercmaster™ III Low Profile Luminaires

High Pressure Sodium and Pulse Start Metal Halide

Listed for simultaneous exposure to combustible dusts and flammable gases or vapors.

NEC/CEC:

Class I, Division 2, Groups A, B, C, D
 Class I, Zone 2, AEx nA nR IIC (Z2)
 Class I, Zone 2, AEx nR IIC (ZB)
 Class II, Division 1 and 2, Groups E, F, G
 Class III

NEC/CEC:

Simultaneous Exposure
 (Class I, Division 2/Class II, Division 1)
 Fixtures Outside Type (Salt Water)
 Type 4X
 IP66

Dimensions in Millimeters (Inches)

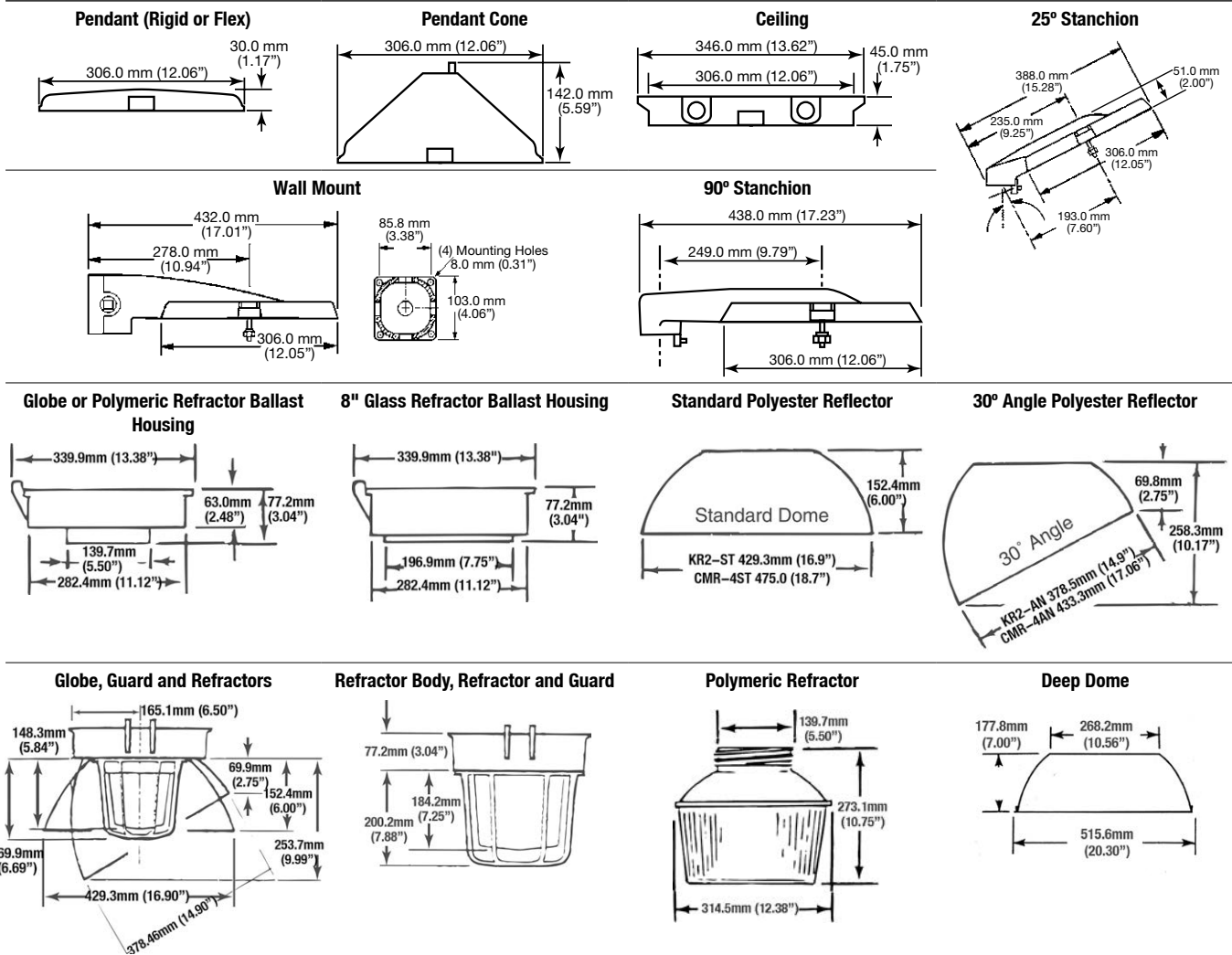

Mercmaster III Low Profile Ballast and Accessory Weights ①

Watts	Globe Housing Ballast Wt. kg (lb)		Refractor Housing Ballast Wt. kg (lb)		Mounting Hoods	Wt. Kg (Lb)	Refractors, Globes, Guards and Reflectors	Wt. Kg (Lb)
	HPS	PSMH	HPS	PSMH				
50	3.3 (7.28)	3.2 (7.05)	3.5 (7.72)	3.4 (7.50)	Pendant	1.0 (2.20)	8" Glass Refractor	2.4 (5.29)
70	3.7 (8.16)	3.5 (7.72)	4.0 (8.82)	3.7 (8.16)	Pendant Cone	1.1 (2.43)	Glass Globe	1.7 (3.75)
100	4.4 (9.70)	4.2 (9.26)	4.6 (10.14)	4.4 (9.70)	Ceiling	1.4 (3.09)	Refractor Guard	0.5 (1.10)
150	4.9 (10.80)	4.9 (10.80)	5.1 (11.24)	5.1 (11.24)	Wall	1.8 (3.97)	Globe Guard	0.5 (1.10)
175	—	5.0 (11.02)	—	5.2 (11.46)	25° Stanchion	1.5 (3.31)	Standard Dome	1.1 (2.43)
					90° Stanchion	1.7 (3.75)	Deep Dome	2.3 (5.07)
							30° Angle	1.1 (2.43)
							Polymeric Refractor	1.1 (2.43)

① Weights are approximate. Add 0.1 kg (0.25 lbs) for Quartz option.

PCD2 Series Factory Sealed Hazardous Location Photocontrol

For use in Class I, Division 2, Groups A, B, C, D locations

Maintains Class I, Division 2 rating for Mercmaster III – Low Profile, Mercmaster III, and Mercmaster III – 400 Series Luminaires, Mercmaster LED

NEC/CEC:
Class I, Division 2, Groups A, B, C, D
NEMA 4X

Applications

- Encapsulated photocontrol provides automatic dusk-to-dawn lighting control in Class I, Division 2 locations.
- Typical applications include walkways, security areas and any other outdoor lighting application.
- For use with Mercmaster III – Low Profile, Mercmaster III, and Mercmaster III – 400 Series Luminaires.
- For remote mounting in FS Boxes.

- 50-400 W HID, incandescent or fluorescent, 50/60 Hz.
- 1000 V.A. Voltage/Ampere
- Minimum time delay: 15 seconds to eliminate nuisance tripping.
- Provided with (3) 18 AWG stranded leads 152.4 mm (6.00 in) in length.
- Will fit through standard 1/2" knockout.
- Supplied with locknut and gasket.

Features



- Factory sealed design eliminates the need for an explosionproof enclosure.
- Can be easily installed in the field.
- Solid state design for performance and reliability.
- Available for 120, 208, 240, or 277 volts.

Materials

- Encapsulated with epoxy sealing compound
- FS: aluminum

NEC/CEC Certifications and Compliances

- UL Standard: 1604 – Hazardous (Classified) Locations
- cULus Recognized

	Voltage Range	Max VA	Max Current Amps	Suffix Designation Catalog Number
Factory-Installed Photocontrol - Not for ceiling or pendant cone.				
<i>Add to fixture catalog after voltage; i.e.: KPWBL1075MTH1.</i>				
	120 V, 50/60 Hz	1000	—	H1
	208 V, 50/60 Hz	1000	—	H2
	240 V, 50/60 Hz	1000	—	H3
	277 V, 50/60 Hz	1000	—	H4
Photocontrol for Field Installation				
	120 V, 50/60 Hz	1000	8.3 Amp	PC120D2
	208 V, 50/60 Hz	1000	4.8 Amp	PC247D2
	240 V, 50/60 Hz	1000	4.2 Amp	
	277 V, 50/60 Hz	1000	3.6 Amp	
Photocontrol in FS Cover for Use with FS/FD Box				
<i>Supplied with two stainless steel screws. For neoprene gasket, order catalog number FS-GKR-1N.</i>				
	120 V, 50/60 Hz	1000	8.3 Amp	FSKA-PC120D2
	208, 50/60 Hz	1000	4.8 Amp	FSKA-PC247D2
	240 V, 50/60 Hz	1000	4.2 Amp	
	277 V, 50/60 Hz	1000	3.6 Amp	

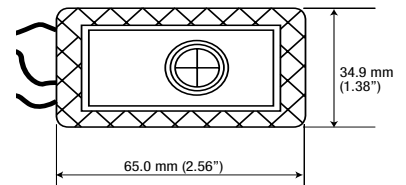
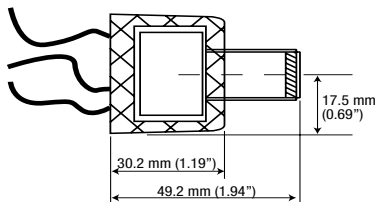
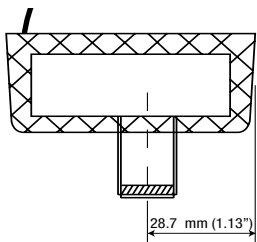

Mercmaster™ III Low Profile Luminaires

150 W HPS

* Photometric data is based on a fixture with a 150-watt clear High Pressure Sodium lamp (16,000 lumen). For candlepower values of fixtures with other HPS lamps, use the following multipliers: for a 100 W (9,500 lumen) HPS lamp – 0.594; for a 70 W (6,400 lumen) HPS lamp – 0.40; for a 50 W (4,000 lumen) HPS lamp – 0.25. For candlepower values of fixture with guard, multiply by – 0.95.

NEC/CEC:
 Class I, Division 2, Groups A, B, C, D
 Class I, Zone 2, AEx nA nR IIC (Z2)
 Class I, Zone 2, AEx nR IIC (ZB)
 Class II, Division 1 and 2, Groups E, F, G
 Class III

NEC/CEC:
 Simultaneous Exposure
 (Class I, Division 2/Class II, Division 1)
 Fixtures Outside Type (Salt Water)
 Type 4X
 IP66

Photometric Data

Zone	Lumens	Total Luminaire Efficiency = 83%											
0-10	28.58	CIE Type – Semi-Direct											
10-20	123.97	<table border="1"> <thead> <tr> <th>Plane</th> <th>Spacing Criteria</th> </tr> </thead> <tbody> <tr> <td>0-180</td> <td>3.9</td> </tr> <tr> <td>90-270</td> <td>3.9</td> </tr> <tr> <td>Diagonal</td> <td>3.7</td> </tr> </tbody> </table>				Plane	Spacing Criteria	0-180	3.9	90-270	3.9	Diagonal	3.7
Plane	Spacing Criteria												
0-180	3.9												
90-270	3.9												
Diagonal	3.7												
20-30	304.16												
30-40	513.64												
40-50	889.19												
50-60	1299.53												
60-70	1506.73												
70-80	1706.16	Zonal Lumen Summary											
80-90	1800.53	Zone	Lumens	% Lamp	% Fixture								
90-100	1791.58	0-30	4563.72	2.9	3.4								
100-110	1652.69	0-40	970.35	6.1	7.3								
110-120	1311.22	0-60	3159.07	19.7	23.8								
120-130	351.25	0-90	8172.49	51.1	61.5								
130-140	5.14	90-120	4755.49	29.7	35.8								
140-150	0.00	90-130	5106.74	31.9	38.4								
150-160	0.00	90-150	5111.87	31.9	38.4								
160-170	0.00	90-180	5111.87	31.9	38.5								
170-180	0.00	0-180	13284.37	83.0	100.0								

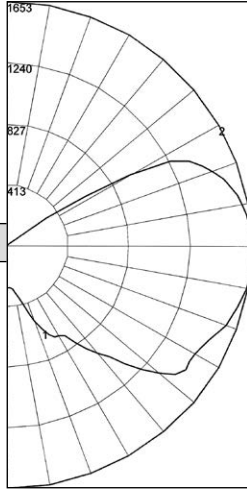

REPORT NUMBER: **ML15LG**

Lamps: 150 W High Pressure Sodium with Globe only *

Coefficients of Utilization – Zonal Cavity Method

Effective Floor Cavity Reflectance 0.20

% Ceiling Rcc	80	70				50				30				10				0	
		70	50	30	10	70	50	30	10	50	30	10	50	30	10				
% Walls	Rw	70	50	30	10	70	50	30	10	50	30	10	50	30	10	50	30	10	0
0	91	91	91	91	85	85	85	85	75	75	75	65	65	65	55	55	55	55	51
1	77	71	66	61	72	66	61	57	57	53	49	48	45	42	40	37	35	31	31
2	68	59	51	45	63	55	48	42	46	41	36	39	34	31	32	28	25	21	21
3	61	50	42	35	56	46	39	33	39	33	28	32	27	23	26	22	19	16	16
4	55	43	35	28	50	40	32	26	34	27	22	28	23	18	22	18	15	12	12
5	50	38	29	23	46	35	27	21	29	23	18	24	19	15	19	15	12	9	9
6	46	33	25	19	42	31	23	18	26	20	15	21	16	12	17	13	10	7	7
7	42	30	22	16	38	27	20	15	23	17	13	19	14	10	15	11	8	6	6
8	39	27	19	14	36	25	18	13	21	15	11	17	12	9	14	10	7	5	5
9	36	24	17	12	33	22	16	11	19	13	9	16	11	8	13	9	6	4	4
10	33	22	15	11	31	20	14	10	17	12	8	15	10	7	12	8	5	4	4

Zone	Lumens	Total Luminaire Efficiency = 73.2%											
0-10	219.96	CIE Type – Direct											
10-20	683.41	<table border="1"> <thead> <tr> <th>Plane</th> <th>Spacing Criteria</th> </tr> </thead> <tbody> <tr> <td>0-180</td> <td>1.64</td> </tr> <tr> <td>90-270</td> <td>1.64</td> </tr> <tr> <td>Diagonal</td> <td>1.88</td> </tr> </tbody> </table>				Plane	Spacing Criteria	0-180	1.64	90-270	1.64	Diagonal	1.88
Plane	Spacing Criteria												
0-180	1.64												
90-270	1.64												
Diagonal	1.88												
20-30	1267.92												
30-40	1613.68												
40-50	1967.79												
50-60	2333.86												
60-70	2328.33												
70-80	1118.52	Zonal Lumen Summary											
80-90	174.91	Zone	Lumens	% Lamp	% Fixture								
90-100	1.23	0-30	2171.29	13.6	18.5								
100-110	0.00	0-40	3784.97	23.7	32.3								
110-120	0.00	0-60	8086.62	50.5	69.1								
120-130	0.00	0-90	11708.37	73.2	100.0								
130-140	0.00	90-120	1.23	0.0	0.0								
140-150	0.00	90-130	1.23	0.0	0.0								
150-160	0.00	90-150	1.23	0.0	0.0								
160-170	0.00	90-180	1.23	0.0	0.0								
170-180	0.00	0-180	11709.6	73.2	100.0								

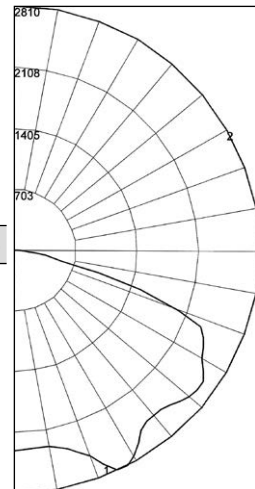

REPORT NUMBER: **ML15LST**

Lamps: 150 W High Pressure Sodium with Standard Dome Reflector *

Coefficients of Utilization – Zonal Cavity Method

Effective Floor Cavity Reflectance 0.20

% Ceiling Rcc	80	70				50				30				10				0	
		70	50	30	10	70	50	30	10	50	30	10	50	30	10				
% Walls	Rw	70	50	30	10	70	50	30	10	50	30	10	50	30	10	50	30	10	0
0	87	87	87	87	85	85	85	85	81	81	81	78	78	78	75	75	75	73	73
1	79	75	71	68	77	73	70	67	70	67	65	67	65	63	64	62	61	59	59
2	70	63	58	53	68	62	57	52	59	55	51	57	53	50	55	52	49	47	47
3	63	54	48	42	61	53	47	42	51	46	41	49	44	40	47	43	40	38	38
4	57	47	40	35	55	46	39	34	44	38	34	42	37	33	41	36	33	31	31
5	52	41	34	29	50	41	34	29	39	33	28	37	32	28	36	31	28	26	26
6	48	37	30	24	46	36	29	24	35	29	24	33	28	24	32	27	24	22	22
7	44	33	26	21	42	32	26	21	31	25	21	30	25	21	29	24	20	19	19
8	41	30	23	18	39	29	23	18	28	22	18	27	22	18	26	22	18	16	16
9	38	27	21	16	37	27	20	16	26	20	16	25	20	16	24	19	16	14	14
10	35	25	19	15	34	24	18	14	24	18	14	23	18	14	22	18	14	13	13

Mercmaster™ III Low Profile Luminaires

150 W HPS

* Photometric data is based on a fixture with a 150-watt clear High Pressure Sodium lamp (16,000 lumen). For candlepower values of fixtures with other HPS lamps, use the following multipliers: for a 100 W (9,500 lumen) HPS lamp – 0.594; for a 70 W (6,400 lumen) HPS lamp – 0.40; for a 50 W (4,000 lumen) HPS lamp – 0.25. For candlepower values of fixture with guard, multiply by – 0.95.

NEC/CEC:
 Class I, Division 2, Groups A, B, C, D
 Class I, Zone 2, AEx nA nR IIC (Z2)
 Class I, Zone 2, AEx nR IIC (ZB)
 Class II, Division 1 and 2, Groups E, F, G
 Class III

NEC/CEC:
 Simultaneous Exposure
 (Class I, Division 2/Class II, Division 1)
 Fixtures Outside Type (Salt Water)
 Type 4X
 IP66

Photometric Data

Zone	Lumens	Total Luminaire Efficiency = 68.4%											
0-10	168.01	CIE Type – Direct											
10-20	536.92	<table border="1"> <thead> <tr> <th>Plane</th> <th>Spacing Criteria</th> </tr> </thead> <tbody> <tr> <td>0-180</td> <td>2.3</td> </tr> <tr> <td>90-270</td> <td>2.0</td> </tr> <tr> <td>Diagonal</td> <td>1.8</td> </tr> </tbody> </table>				Plane	Spacing Criteria	0-180	2.3	90-270	2.0	Diagonal	1.8
Plane	Spacing Criteria												
0-180	2.3												
90-270	2.0												
Diagonal	1.8												
20-30	972.38												
30-40	1342.99												
40-50	1625.08												
50-60	1721.88												
60-70	1586.98												
70-80	1369.71	Zonal Lumen Summary											
80-90	995.76	Zone	Lumens	% Lamp	% Fixture								
90-100	461.94	0-30	1677.30	10.5	15.3								
100-110	127.24	0-40	3020.29	18.9	27.6								
110-120	27.54	0-60	6367.25	39.8	58.2								
120-130	4.31	0-90	10319.70	64.5	94.3								
130-140	2.68	90-120	616.71	3.9	5.6								
140-150	0.00	90-130	621.02	3.9	5.7								
150-160	0.00	90-150	623.70	3.9	5.7								
160-170	0.00	90-180	623.70	3.9	5.7								
170-180	0.00	0-180	10943.41	68.4	100.0								

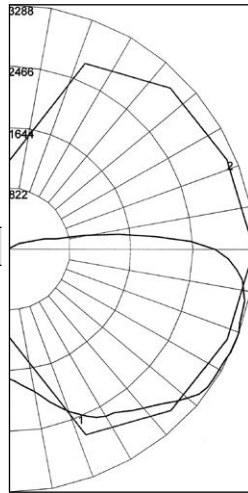

REPORT NUMBER: **ML15LAN**

Lamps: 150 W High Pressure Sodium with
 30° Angle Dome Reflector *

Coefficients of Utilization – Zonal Cavity Method

Effective Floor Cavity Reflectance 0.20

% Ceiling Rcc	80	70			50			30			10			0			
		70	50	30	10	70	50	30	10	50	30	10					
% Walls	Rw	70	50	30	10	70	50	30	10	50	30	10	50	30	10	0	
0	80	80	80	80	78	78	78	78	74	74	74	70	70	70	66	66	66
1	70	66	62	58	68	64	60	57	60	57	54	57	54	52	54	52	48
2	63	56	50	45	60	54	49	44	51	46	42	48	44	41	45	42	37
3	56	48	41	36	54	46	40	35	44	38	34	41	37	33	39	35	30
4	51	42	35	29	49	40	34	29	38	32	28	36	31	27	34	30	26
5	47	37	30	24	45	36	29	24	34	28	23	32	27	23	30	26	22
6	43	33	26	21	41	32	25	20	30	24	20	28	23	19	27	22	19
7	39	29	23	18	38	28	22	18	27	21	17	26	21	17	24	20	16
8	37	26	20	16	35	26	20	15	24	19	15	23	18	15	22	18	14
9	34	24	18	14	33	23	18	14	22	17	13	21	17	13	20	16	13
10	32	22	16	12	31	22	16	12	21	15	12	20	15	12	19	15	11

Zone	Lumens	Total Luminaire Efficiency = 77.6%											
0-10	16.51	CIE Type – Semi-Direct											
10-20	135.03	<table border="1"> <thead> <tr> <th>Plane</th> <th>Spacing Criteria</th> </tr> </thead> <tbody> <tr> <td>0-180</td> <td>2.22</td> </tr> <tr> <td>90-270</td> <td>2.20</td> </tr> <tr> <td>Diagonal</td> <td>3.50</td> </tr> </tbody> </table>				Plane	Spacing Criteria	0-180	2.22	90-270	2.20	Diagonal	3.50
Plane	Spacing Criteria												
0-180	2.22												
90-270	2.20												
Diagonal	3.50												
20-30	274.24												
30-40	463.44												
40-50	1125.38												
50-60	1688.89												
60-70	3137.76												
70-80	2421.27	Zonal Lumen Summary											
80-90	1145.98	Zone	Lumens	% Lamp	% Fixture								
90-100	411.16	0-30	425.77	2.7	3.4								
100-110	632.32	0-40	889.22	5.6	7.2								
110-120	448.30	0-60	3703.50	23.1	29.8								
120-130	293.08	0-90	10408.50	65.1	83.8								
130-140	154.61	90-120	1491.78	9.3	12.0								
140-150	59.30	90-130	1784.86	11.2	14.4								
150-160	9.99	90-150	1998.77	12.5	14.4								
160-170	0.49	90-180	2009.26	12.6	16.2								
170-180	0.00	0-180	12417.76	77.6	100.0								

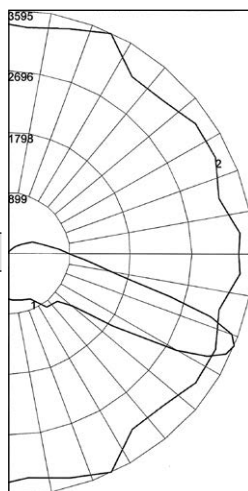

REPORT NUMBER: **ML15LJ5**

Lamps: 150 W High Pressure Sodium with
 8" Prismatic Glass Refractor – NEMA Type V *

Coefficients of Utilization – Zonal Cavity Method

Effective Floor Cavity Reflectance 0.20

% Ceiling Rcc	80	70			50			30			10			0			
		70	50	30	10	70	50	30	10	50	30	10					
% Walls	Rw	70	50	30	10	70	50	30	10	50	30	10	50	30	10	0	
0	89	89	89	89	86	86	86	86	79	79	79	73	73	73	68	68	68
1	76	70	65	60	72	67	62	58	61	57	54	56	53	50	51	48	46
2	66	56	49	42	62	54	47	41	49	43	38	44	39	35	40	36	32
3	58	46	38	31	54	44	36	30	40	33	27	36	30	25	32	27	23
4	51	39	30	23	48	37	29	22	33	26	21	30	24	19	27	22	17
5	46	34	25	18	43	32	24	18	29	22	16	26	20	15	23	18	13
6	42	29	21	15	40	28	20	14	25	18	13	22	16	12	20	15	11
7	39	26	18	12	36	25	17	12	22	15	11	20	14	10	18	13	9
8	36	23	15	10	33	22	15	10	20	13	9	18	12	8	16	11	7
9	33	21	14	9	31	20	13	8	18	12	8	16	11	7	15	10	6
10	31	19	12	8	29	18	12	7	17	11	7	15	10	6	13	9	5

Mercmaster™ III Low Profile Luminaires

100 W PSMH

* Photometric data is based on a fixture with a 100-watt clear Pulse Start Metal Halide lamp (8,500 lumen). For candlepower values of fixtures with other PSMH lamps, use the following multipliers: for a 50 W (3400 lumen) PSMH lamp – 0.40; for a 70 W (5600 lumen) PSMH lamp – 0.66; for a 150 W (10,500 lumen) PSMH lamp – 1.24; for a 175 W (17,500 lumen) PSMH lamp – 2.06. For candlepower values of fixture with guard, multiply by – 0.95.

NEC/CEC:
 Class I, Division 2, Groups A, B, C, D
 Class I, Zone 2, AEx nA nR IIC (Z2)
 Class I, Zone 2, AEx nR IIC (ZB)
 Class II, Division 1 and 2, Groups E, F, G
 Class III

NEC/CEC:
 Simultaneous Exposure
 (Class I, Division 2/Class II, Division 1)
 Fixtures Outside Type (Salt Water)
 Type 4X
 IP66

Photometric Data

Zone	Lumens	Total Luminaire Efficiency = 85.7%			
0-10	21.19	CIE Type – Semi-Direct			
10-20	93.55	Plane	Spacing Criteria		
20-30	201.68				
30-40	291.92	0-180	3.20		
40-50	523.42	90-270	3.20		
50-60	637.38	Diagonal	3.08		
60-70	732.34				
70-80	845.58	Zonal Lumen Summary			
80-90	874.42	Zone	Lumens	% Lamp	% Fixture
90-100	870.80	0-30	316.42	4.1	4.7
100-110	809.33	0-40	608.33	7.8	9.1
110-120	643.44	0-60	1769.13	22.7	26.5
120-130	139.00	0-90	4221.46	54.1	63.2
130-140	0.71	90-120	2323.56	29.8	34.8
140-150	0.00	90-130	2462.56	31.6	36.8
150-160	0.00	90-150	2463.27	31.6	36.8
160-170	0.00	90-180	2463.27	31.6	36.8
170-180	0.00	0-180	6684.73	85.7	100.0

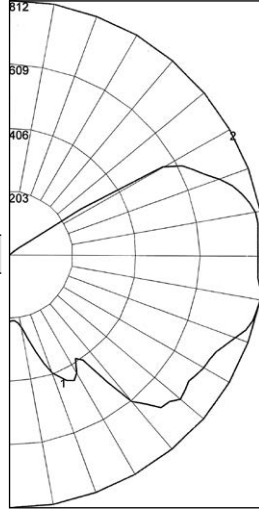

REPORT NUMBER: **ML10HG**

Lamps: 100 W Pulse Start Metal Halide with Globe only *

Coefficients of Utilization – Zonal Cavity Method

Effective Floor Cavity Reflectance 0.20

% Ceiling Rcc	80	70				50				30				10				0			
		70	50	30	10	70	50	30	10	50	30	10	50	30	10	50	30	10	0		
0	95	95	95	95	89	89	89	89	78	78	78	68	68	68	58	58	58	58	54		
1	81	74	69	64	75	69	64	60	60	56	52	51	48	45	43	40	38	34	34		
2	71	62	54	48	66	57	50	45	49	43	39	41	37	33	34	31	28	24	24		
3	64	52	44	37	59	49	41	35	41	35	30	35	30	26	29	25	21	18	18		
4	57	45	37	30	53	42	34	28	36	29	24	30	25	20	25	20	17	14	14		
5	52	40	31	25	48	37	29	23	31	25	20	26	21	17	21	17	14	11	11		
6	48	35	27	21	44	33	25	19	28	21	17	23	18	14	19	15	11	9	9		
7	44	31	23	17	40	29	22	16	25	19	14	21	16	12	17	13	10	7	7		
8	41	28	20	15	37	26	19	14	22	16	12	19	14	10	16	11	8	6	6		
9	38	26	18	13	35	24	17	12	20	15	11	17	12	9	14	10	7	5	5		
10	35	23	16	12	32	22	15	11	19	13	9	16	11	8	13	9	6	5	5		

Zone	Lumens	Total Luminaire Efficiency = 75.8%			
0-10	116.29	CIE Type – Direct			
10-20	371.61	Plane	Spacing Criteria		
20-30	692.88				
30-40	821.73	0-180	1.70		
40-50	1064.03	90-270	1.70		
50-60	1154.58	Diagonal	1.84		
60-70	1134.19				
70-80	470.22	Zonal Lumen Summary			
80-90	83.66	Zone	Lumens	% Lamp	% Fixture
90-100	0.82	0-30	1180.78	15.1	20.0
100-110	0.00	0-40	2002.50	25.7	33.9
110-120	0.00	0-60	4221.11	54.1	71.4
120-130	0.00	0-90	5909.17	75.8	100.0
130-140	0.00	90-120	0.82	0.0	0.0
140-150	0.00	90-130	0.82	0.0	0.0
150-160	0.00	90-150	0.82	0.0	0.0
160-170	0.00	90-180	0.82	0.0	0.0
170-180	0.00	0-180	5910.00	75.8	100.0

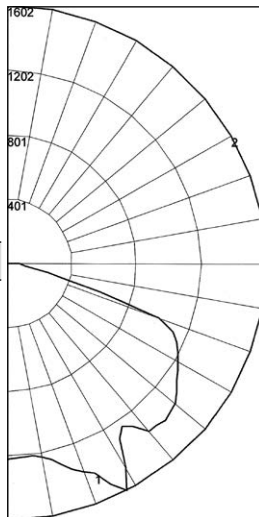

REPORT NUMBER: **ML10HST**

Lamps: 100 W Pulse Start Metal Halide with Standard Dome Reflector *

Coefficients of Utilization – Zonal Cavity Method

Effective Floor Cavity Reflectance 0.20

% Ceiling Rcc	80	70				50				30				10				0			
		70	50	30	10	70	50	30	10	50	30	10	50	30	10	50	30	10	0		
0	90	90	90	90	88	88	88	88	84	84	84	81	81	81	77	77	77	76	76		
1	82	78	74	71	80	76	73	70	73	70	68	70	68	66	67	65	64	62	62		
2	73	66	61	56	71	65	60	55	62	58	54	60	56	53	57	54	51	50	50		
3	66	57	50	45	64	56	50	45	54	48	44	51	47	43	49	46	42	40	40		
4	60	50	43	37	58	49	42	37	47	41	36	45	40	36	43	39	35	33	33		
5	54	44	36	31	53	43	36	31	41	35	30	40	34	30	38	33	30	28	28		
6	50	39	32	26	48	38	31	26	37	31	26	35	30	26	34	29	25	24	24		
7	46	35	28	23	45	34	27	23	33	27	22	32	26	22	31	26	22	20	20		
8	43	32	25	20	41	31	24	20	30	24	20	29	24	20	28	23	19	18	18		
9	40	29	22	18	38	28	22	18	27	22	17	27	21	17	36	21	17	16	16		
10	37	26	20	16	36	26	20	16	25	20	16	24	19	16	24	19	15	14	14		

Mercmaster™ III Low Profile Luminaires

100 W PSMH

* Photometric data is based on a fixture with a 100-watt clear Pulse Start Metal Halide lamp (8,500 lumen). For candlepower values of fixtures with other PSMH lamps, use the following multipliers: for a 50 W (3400 lumen) PSMH lamp – 0.40; for a 70 W (5600 lumen) PSMH lamp – 0.66; for a 150 W (10,500 lumen) PSMH lamp – 1.24; for a 175 W (17,500 lumen) PSMH lamp – 2.06. For candlepower values of fixture with guard, multiply by – 0.95.

NEC/CEC:

Class I, Division 2, Groups A, B, C, D
 Class I, Zone 2, AEx nA nR IIC (Z2)
 Class I, Zone 2, AEx nR IIC (ZB)
 Class II, Division 1 and 2, Groups E, F, G
 Class III

NEC/CEC:

Simultaneous Exposure
 (Class I, Division 2/Class II, Division 1)
 Fixtures Outside Type (Salt Water)
 Type 4X
 IP66

Photometric Data

Zone	Lumens	Total Luminaire Efficiency = 71.3%			
0-10	91.83	CIE Type – Direct			
10-20	301.65	Plane		Spacing Criteria	
20-30	543.23	0-180	2.08		
30-40	703.02	90-270	2.06		
40-50	877.11	Diagonal	1.76		
50-60	850.33				
60-70	7753.51	Zonal Lumen Summary			
70-80	667.27	Zone	Lumens	% Lamp	% Fixture
80-90	471.44	0-30	936.72	12.0	16.8
90-100	200.90	0-40	1639.74	21.0	29.5
100-110	62.89	0-60	3367.18	43.2	60.6
110-120	14.42	0-90	5281.39	67.7	95.0
120-130	1.07	0-120	278.21	3.6	5.0
130-140	0.00	90-120	279.28	3.6	5.0
140-150	0.00	90-130	279.28	3.6	5.0
150-160	0.00	90-150	279.28	3.6	5.0
160-170	0.00	90-180	279.28	3.6	5.0
170-180	0.00	0-180	5560.68	71.3	100.0

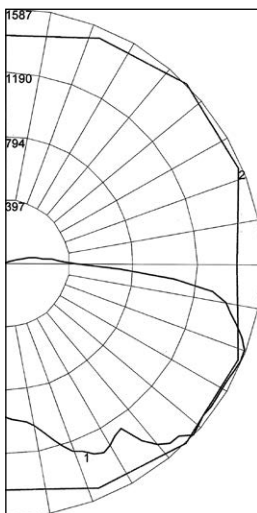

REPORT NUMBER: **ML10HAN**

Lamps: 100 W Pulse Start Metal Halide with
 30° Angle Dome Reflector *

Coefficients of Utilization – Zonal Cavity Method

Effective Floor Cavity Reflectance 0.20

% Ceiling Rcc	80				70				50				30				10				0
	% Walls	Rw	70	50	30	10	70	50	30	10	50	30	10	50	30	10	50	30	10		
0	84	84	84	84	82	82	82	82	77	77	77	73	73	73	69	69	69	68	68	68	
1	74	69	65	62	71	67	64	60	63	60	58	60	57	55	57	55	53	51	51	51	
2	66	59	53	48	64	57	51	47	54	49	45	51	47	43	48	45	42	40	40	40	
3	59	51	44	38	57	49	43	38	46	41	36	44	39	35	41	37	34	32	32	32	
4	54	44	37	31	52	43	36	31	40	35	30	38	33	29	36	32	28	27	27	27	
5	49	39	32	26	47	38	31	26	36	30	25	34	29	25	32	28	24	22	22	22	
6	45	35	28	23	43	34	27	22	32	26	22	30	25	21	29	24	21	19	19	19	
7	42	31	24	20	40	30	24	19	29	23	19	27	22	18	26	22	18	16	16	16	
8	39	28	22	17	37	28	21	17	26	21	17	25	20	16	24	19	16	14	14	14	
9	36	26	19	15	35	25	19	15	24	19	15	23	18	14	22	17	14	13	13	13	
10	34	24	18	14	32	23	17	13	22	17	13	21	16	13	20	16	13	11	11	11	

Zone	Lumens	Total Luminaire Efficiency = 76.6%			
0-10	9.17	CIE Type – Semi-Direct			
10-20	75.43	Plane		Spacing Criteria	
20-30	154.76	0-180	2.06		
30-40	266.34	90-270	2.20		
40-50	632.54	Diagonal	3.26		
50-60	1155.59				
60-70	1665.76	Zonal Lumen Summary			
70-80	693.73	Zone	Lumens	% Lamp	% Fixture
80-90	449.28	0-30	239.35	3.1	4.0
90-100	177.44	0-40	505.69	6.5	8.5
100-110	288.25	0-60	2293.81	29.4	38.4
110-120	208.52	0-90	5102.58	65.4	85.4
120-130	128.19	90-120	674.20	8.6	11.3
130-140	56.80	90-130	802.38	10.3	13.4
140-150	14.94	90-150	874.12	11.2	13.4
150-160	0.10	90-180	874.22	11.2	14.6
160-170	0.00	0-180	5976.80	76.6	100.0
170-180	0.00				

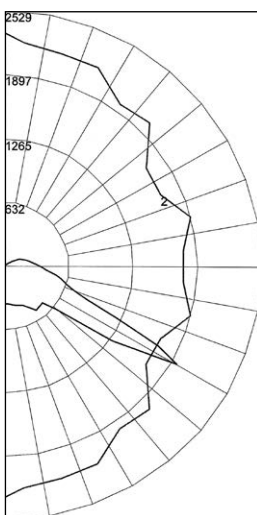

REPORT NUMBER: **ML10HJ5**

Lamps: 100 W Pulse Start Metal Halide with
 8" Prismatic Glass Refractor – NEMA Type V *

Coefficients of Utilization – Zonal Cavity Method

Effective Floor Cavity Reflectance 0.20

% Ceiling Rcc	80				70				50				30				10				0
	% Walls	Rw	70	50	30	10	70	50	30	10	50	30	10	50	30	10	50	30	10		
0	89	89	89	89	85	85	85	85	79	79	79	73	73	73	68	68	68	65	65	65	
1	77	71	67	62	73	68	64	60	63	59	56	58	55	52	53	51	49	46	46	46	
2	67	58	51	45	64	56	49	44	51	46	41	47	42	38	43	39	36	33	33	33	
3	59	48	40	34	56	46	39	32	42	36	30	38	33	28	34	30	26	24	24	24	
4	52	41	32	26	49	39	31	25	35	28	23	32	26	21	29	24	20	18	18	18	
5	47	35	26	20	44	33	25	19	30	23	18	27	21	17	25	20	15	13	13	13	
6	43	30	22	16	40	29	21	15	26	19	14	24	18	13	21	16	12	10	10	10	
7	39	27	19	13	37	25	18	13	23	16	12	21	15	11	19	14	10	8	8	8	
8	36	24	16	11	34	23	15	10	21	14	10	19	13	9	17	12	8	6	6	6	
9	33	21	14	9	31	20	14	9	19	12	8	17	11	8	15	10	7	5	5	5	
10	31	19	12	8	29	19	12	8	17	11	7	15	10	6	14	9	6	4	4	4	

Mercmaster™ III Low Profile Luminaires

High Pressure Sodium, Pulse Start Metal Halide and Metal Halide

Listed for simultaneous exposure to combustible dusts and flammable gases or vapors.

CEC:
Class I, Division 2, Groups A, B, C, D
Class I, Zone 2 Ex nR IIC (Z)
Class II, Division 1 and 2, Groups E, F, G
Class III

CEC:
Type 4X
IP66

Applications

- Enclosed and gasketed fixtures suitable for use in:
 - Marine and wet locations
 - A wide range of industrial, chemical processing and other areas where flammable gases and vapors or combustible dusts are present under conditions defined by the National Electrical Code as Class I, Division 2; Class II, Division 1 and 2; and Class III
 - Areas of low clearance, low ceiling heights or where fixture weights must be minimized
 - For Zone 2, the method of protection is Ex nR – Restricted Breathing
 - Non-hazardous locations where severe weather conditions, excessive moisture, dirt, dust, corrosive atmosphere or high ambient temperatures are encountered
- Typical applications include:
 - Pulp and paper mills
 - Processing plants
 - Chemical plants
 - Oil refineries
 - Foundries
 - Manufacturing plants
 - Storage areas
 - Waste and sewage treatment
 - Parking garages
 - Other areas where dust, water, dirt and rough usage are a problem

Features

- Compact light weight low profile design is suited for low mounting heights in conjunction with lower wattage fixtures.
- Modular design allows scores of fixture component combinations to meet installation and lighting needs. Uses same mounting hoods and optical accessories as Mercmaster III.
- A choice of heat-resistant prismatic glass refractors (NEMA I, III or V) or heat-resistant globes which thread directly into ballast housing. Photometrics available upon request – contact your local sales representative.
- Standard dome or 30° angle reflectors made of fiberglass reinforced white polyester. Highly resistant to corrosive atmospheres.
- Accommodates medium base lamps.
- A wide range of voltages available (120 to 600 Volt) and ballast types (Reactor, CWA, CWI and Super CWA).
- Medium base lamp type and watts:
 - HPS 50 W-150 W
 - PSMH 50 W-175 W ①
- Hinge has high lip for added safety during installation and servicing. Hinge and bolt construction assures 360° compression at all points on ballast housing gasket for positive sealing. Swing away design of captive bolt and nut simplifies servicing.
- All Mercmaster III mounting hoods have provision for easy field installation of fuses in fixtures (see fuse kits).
- Fixtures are for use in Class I, Zone 2 hazardous locations.
- The Ex nR factory sealed Mercmaster III prevents vapors and gases from entering the globe chamber. There are no seals or putty required which will reduce installation time and installation errors.



Low Profile Mercmaster III with Prismatic Globe and Guard

Standard Materials

- Mounting hoods, bodies and guard: cast copperfree (4/10 of 1% max.) aluminum
- All hardware and catch assemblies: stainless steel
- Reflectors: Fiberglass reinforced white polyester
- Globes and Refractors: heat-resistant prismatic glass

Standard Finishes

- Mounting hoods, bodies and guards: baked gray epoxy-clad finish, electrostatically applied for complete uniform protection

Options

- Quartz Auxiliary comes to full brightness immediately and remains lit until the HID lamp attains 60-70% of full illumination. Quartz Auxiliary supplied with relay switch and socket to accept 120 V quartz double-contact bayonet base lamp (not included). Add suffix **-E** ①.
- Guards with gray epoxy painted to match fixtures, supplied with stainless steel screws. Add suffix **-G** before voltage suffix.
- Hot Restrike to restrike HPS lamp immediately when power is restored after a momentary power interruption. Add suffix **-R**.
- Smart Starter incorporates a 1-1/2 minute timer and performs as a conventional starter to normally start lamp. Removes itself from circuit if lamp burns out or is removed from socket. Eliminates starter failures caused by prolonged operation with cycling or failing lamps and simplifies finding their location, reducing maintenance and repair costs. Available for all fixtures. Add suffix **-S**.
- Ex nR fixtures, add suffix **-Z**.
- Reflectors are available as standard dome and 30° angle polyester. Order separately.

CEC Certifications and Compliances ②

- CSA Certified: 025428
- CSA Standard: CSA C22.2 No. 9, C22.2 No. 137; CAN/CSA E60079-0, E60079-15

Related Products

- Photocells for classified use are available, see *PCD2 Series*.

① Fixtures equipped with quartz auxiliary lamp do not comply with CEC requirements and are not suitable for use in classified locations.

② Compliance data varies for specific fixtures. Consult Appleton regarding suitability of specific fixtures for a particular application.

③ Mercury vapor and metal halide luminaires are not available for purchase within the United States. Please check with your countries governing legislation regarding allowable lamp types before ordering.

Mercmaster™ III Low Profile Luminaires

High Pressure Sodium, Pulse Start Metal Halide and Metal Halide

Listed for simultaneous exposure to combustible dusts and flammable gases or vapors.

CEC:

Class I, Division 2, Groups A, B, C, D
Class I, Zone 2 Ex nR IIC (Z)
Class II, Division 1 and 2, Groups E, F, G
Class III

CEC:

Type 4X
IP66

Illustrated Features



High Temperature Sockets

Medium base high-temperature porcelain sockets.

Aluminum Inner Reflector

Solid aluminum inner reflector (for reflector ballast housings only) improves photometric efficiency.

Globe Chamber

Completely sealed from the ballast housing and outside vapors/air (nR).

Electrical Protection

Ground wire provided to bond mounting hood to ballast housing.

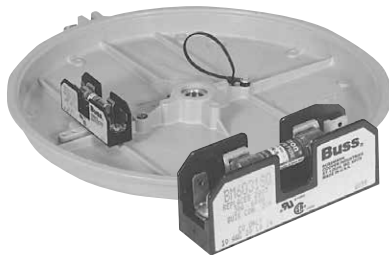

Fuses

Two screws secure fuse kit to mounting boss in any Mercmaster mounting hood. Fuse included.

Photocell

Available for all fixtures except cone and ceiling mount. Installs through knock-out in mounting hood. Provides continuous ON-OFF dusk-to-dawn control.



Vented Reflectors

Reflectors are thick, tough fiberglass-reinforced white polyester, vented for cooler operation. Quickly attach with furnished stainless steel screws.

Stainless Steel Inserts

Ballast bodies have stainless steel threaded inserts to receive stainless steel screws for reflectors and guard. Prevents "freezing", allowing guards and reflectors to be easily removed and replaced at any time, without damage to the housing.

Epoxy Finish

Ballast housing, hoods and guards are copperfree aluminum with epoxy powder coat finish.

Prismatic Glass Globes and Refractors

Heat-resistant globes and refractors thread directly into ballast housing and seal against a high-temperature silicone rubber gasket.



"Safety" High Hinge

Extra-high hinge provides additional protection against accidental ballast housing disengagement during installation or maintenance.



Ballast Assembly

Utilizing non-sparking components avoiding the ignition of gases or vapors that may be present (nA).

Mounting Hood and Globe Gaskets

Silicone rubber gaskets seals out moisture, dirt and dust. Stays flexible, withstands high temperatures. Closure design assures uniform gasket compression.

Terminal Blocks (Zone 2)

A seven-point terminal block is provided to facilitate wiring. Terminal block accommodates wire size ranging from #8 to #24 AWG.



Cooler Operating Cone Hood

Larger sloped surface sheds dusts, dirt and combustible fibers providing better heat dissipation.



Stainless Steel Latch Assembly

Captive, stainless steel latch assembly bolt and nut closes securely, resists attack of corrosive atmospheres. Swing-away design simplifies servicing.

Mercmaster™ III Low Profile Luminaires

High Pressure Sodium, Pulse Start Metal Halide and Metal Halide

Listed for simultaneous exposure to combustible dusts and flammable gases or vapors.

CEC:
 Class I, Division 2, Groups A, B, C, D
 Class I, Zone 2 Ex nR IIC (Z)
 Class II, Division 1 and 2, Groups E, F, G
 Class III

CEC:
 Type 4X
 IP66

Mercmaster III Low Profile Family Tree

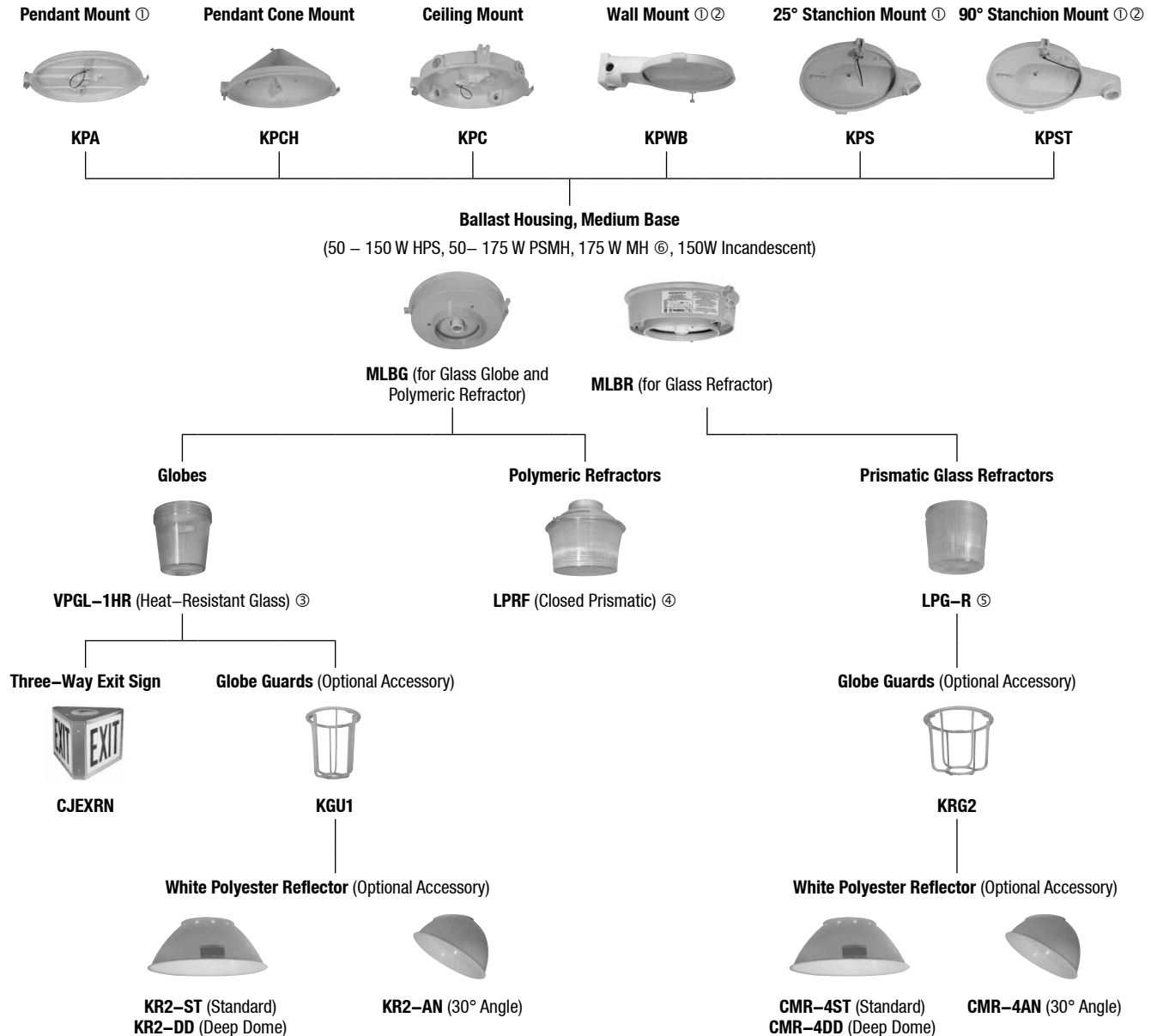

① Mounting hood with a 120 V or 208-277 V factory installed photocell is available.

② Standard and deep dome reflectors may interfere with bottom conduit entry if used with KPST and KPWB mounting hoods..

③ Available in clear, amber, blue, green and red.

④ Available in NEMA Type II, III, IV and V. Polymeric Refractor suitable for Class II, Groups F and G, NEMA 4X and Marine Type Electric Fixtures Outside Type (Salt Water) only (100 W PSMH Max.).

⑤ Available in NEMA Type I, III and V.

⑥ Mercury vapor and metal halide luminaires are not available for purchase within the United States. Please check with your countries governing legislation regarding allowable lamp types before ordering.

Mercmaster™ III Low Profile Luminaires

High Pressure Sodium, Pulse Start Metal Halide and Metal Halide

Listed for simultaneous exposure to combustible dusts and flammable gases or vapors.

CEC:
 Class I, Division 2, Groups A, B, C, D
 Class I, Zone 2 Ex nR IIC (Z)
 Class II, Division 1 and 2, Groups E, F, G
 Class III

CEC:
 Type 4X
 IP66

Order using catalog numbering guide below or select catalog number from tables on following pages.

Catalog Numbering Guide

<p>ML</p> <p>Series: ML - Mercmaster III Low Profile</p>	<p>A</p> <p>Mounting: A - Pendant (rigid mounting) C - Ceiling D - Pendant Cone Hood F - Pendant (flexible mounting) R - 90° Stanchion S - 25° Stanchion W - Wall</p>	<p>L</p> <p>Lamp Type: I - Incandescent H - 175 W Metal Halide L - High Pressure Sodium H - Pulse Start Metal Halide</p>	<p>15</p> <p>Wattage ⑦: 10 - 100 W HPS/MH 15 - 150 W HPS/MH and 60-150 W max. Incandescent 17 - 175 W MH 50 - 50 W HPS/MH 70 - 70 W HPS/MH</p>	<p>2</p> <p>Hub Size: 2 - 3/4" NPT 3 - 1" NPT 4 - 1-1/4" NPT stanchion 5 - 1-1/2" NPT stanchion</p>	<p>G1</p> <p>Optical Assembly: ② G1 - Globe J1 - NEMA I Glass Refractor J3 - NEMA III Glass Refractor J5 - NEMA V Glass Refractor P2 - NEMA II Polymeric Refractor P3 - NEMA III Polymeric Refractor P4 - NEMA IV Polymeric Refractor P5 - NEMA V Polymeric Refractor</p>	<p>G</p> <p>Guard Options: G - Cast Guard N - No Guard</p>	<p>MT</p> <p>Voltage: ① LB - Incandescent, 120 V 60 Hz MT - 120/208/240/277 V 60 Hz TT - 120/277/347 V 60 Hz, CWA C2 - 208 V 60 Hz, CWI C3 - 240 V 60 Hz, CWI C6 - 480 V 60 Hz, CWI C7 - 600 V 60 Hz, CWI</p>	<p>R</p> <p>Options: E - Emergency Quartz ⑤ R - Hot Restrike ③ S - Smart Starter ④ H1 - Photocontrol 120 V H2 - Photocontrol 208 V H3 - Photocontrol 240 V H4 - Photocontrol 277 V C - Safety Cable Adapted D - E-27 Export Socket T - Terminal Blocks V - Anti-Vibration Modifications X - Appledapter ⑥ Mounting Hood Adapter</p>	<p>Z2</p> <p>Suffix: Z - Zone 2 suffix (required for Ex nR)</p>
--	---	--	--	--	---	---	--	--	---

① Other voltages, frequencies available – contact your local sales representative. Voltages shown are limited to specific combinations; refer to following pages.
 ② Polymeric Refractor suitable for Class II, Groups F and G and NEMA 4X only (100 W PSMH Max.). Reflectors ordered separately.
 ③ Available for 50-150 W HPS fixtures only.
 ④ Available for HPS fixtures.
 ⑤ Fixtures equipped with quartz auxiliary lamp do not comply with CEC requirements and are not suitable for use in classified locations.
 ⑥ Appledapter is available for use with the pendant, ceiling and angled stanchion mounting only.
 ⑦ Mercury vapor and metal halide luminaires are not available for purchase within the United States. Please check with your countries governing legislation regarding allowable lamp types before ordering.

 HID/AREA: NEC/CEC ENCLOSED AND GASKETED

Mercmaster™ III Low Profile Luminaires

Class I, Division 2; Class II, Division 1; Simultaneous exposure to hazardous conditions in both classifications

Temperature identification numbers of Mercmaster III Low Profile High Pressure Sodium and Pulse Start Metal Halide

CEC:
Class I, Division 2, Groups A, B, C, D
Class I, Zone 2 Ex nR IIC (Z)
Class II, Division 1 and 2, Groups E, F, G
Class III

CEC:
Type 4X
IP66

Lamp		Supply Wire Min.	Ambient Temp.	Class I, Division 2			Class II, Division 1 Groups E, F and G			Simultaneous Exposure Class I, Division 2 / Class II, Division 1		
Watts	Type	Temp. °C (°F)	°C (°F)	Globe	Reflector	Refractor	Globe	Reflector	Refractor	Globe	Reflector	Refractor
50	HPS	90 °C (194 °F)	40 °C (104 °F)	T3	T3	T3B	T4A	T4A	T5	T3	T3	T3
		90 °C (194 °F)	55 °C (131 °F)	T3	T3	T3A	T4A	T4A	T4A	T2D	T2D	T2D
		90 °C (194 °F)	65 °C (149 °F)	T3	T3	T3A	T4	T4	T4A	T2C	T2C	T2C
70	HPS	90 °C (194 °F)	40 °C (104 °F)	T3	T3	T3	T4	T4	T5	T2B	T2B	T2D
		90 °C (194 °F)	55 °C (131 °F)	T2D	T2D	T3	T3C	T3C	T4A	T2B	T2B	T2C
		90 °C (194 °F)	65 °C (149 °F)	—	—	T3	—	—	T4	—	—	T2B
100	HPS	90 °C (194 °F)	40 °C (104 °F)	T2C	T2C	T2D	T4	T4	T4A	T2B	T2B	T2B
		90 °C (194 °F)	55 °C (131 °F)	T2B	T2B	T2C	T3C	T3C	T4	T2A	T2A	T2A
		90 °C (194 °F)	65 °C (149 °F)	—	—	—	—	—	—	—	—	—
150	HPS	90 °C (194 °F)	40 °C (104 °F)	T2A	T2A	T2B	T3A ①	—	T4	325	—	T2
		90 °C (194 °F)	40 °C (104 °F)	T3	T3	T3A	T4A	T4A	T6	T2D	T2D	T3
		90 °C (194 °F)	55 °C (131 °F)	T3	T3	T3	T4	T4	T5	T2C	T2C	T2D
50	PSMH	90 °C (194 °F)	65 °C (149 °F)	T3	T3	T3	T4	T4	T4A	T2B	T2B	T2D
		90 °C (194 °F)	40 °C (104 °F)	T3	T3	T3	T3C	T3C	T4A	T2B	T2B	T2C
		90 °C (194 °F)	55 °C (131 °F)	T2D	T2D	T3	T3C	T3C	T4A	T2A	T2A	T2B
70	PSMH	110 °C (230 °F)	65 °C (149 °F)	—	—	T3	—	—	T4	—	—	T2B
		90 °C (194 °F)	40 °C (104 °F)	T2A	T2A	T2B	T3B	T3B	T4A	T2	T2	T2A
		90 °C (194 °F)	55 °C (131 °F)	T2A	T2A	T2B	T3A ①	T3A ①	T4	T1	T1	T2
150	PSMH	105 °C (221 °F)	40 °C (104 °F)	350	350	325	—	—	T3B	—	—	T1
175	PSMH	105 °C (221 °F)	40 °C (104 °F)	350	350	325	—	—	T3B	—	—	T1
175	MH ②	110 °C (230 °F)	40 °C (104 °F)	—	—	325	—	—	T3B	—	—	—
60	Inc.	90 °C (194 °F)	40 °C (104 °F)	T3B	T3B	T3C	—	—	—	—	—	—
		90 °C (194 °F)	55 °C (131 °F)	T3A	T3A	T3C	—	—	—	—	—	—
		90 °C (194 °F)	65 °C (149 °F)	T3A	T3A	T3C	—	—	—	—	—	—
100	Inc.	90 °C (194 °F)	40 °C (104 °F)	T3	T3	T3	—	—	—	—	—	—
		90 °C (194 °F)	55 °C (131 °F)	T3	T3	T3	—	—	—	—	—	—
		90 °C (194 °F)	65 °C (149 °F)	T2D	T2D	T3	—	—	—	—	—	—
150	Inc.	90 °C (194 °F)	40 °C (104 °F)	T2D	T2D	T3	—	—	—	—	—	—
		90 °C (194 °F)	55 °C (131 °F)	T2B	T2B	T2D	—	—	—	—	—	—
		90 °C (194 °F)	65 °C (149 °F)	T2B	T2B	T2D	—	—	—	—	—	—

“T” Numbers Represent the Maximum Lamp Temperature for Class I, Division 2 Locations and Maximum Surface Temperature Under Dust Blanket for Class II, Division 1 Locations.

“T” #	T1	350	325	T2	T2A	T2B	T2C	T2D	T3	T3A	T3B	T3C	T4	T4A	T5	T6
Temp. Range (°C)	351-450	326-350	301-325	281-300	261-280	231-260	216-230	201-215	181-200	166-180	161-165	136-160	121-135	101-120	86-100	85
Temp. Range (°F)	664-842	619-662	574-617	538-572	502-536	448-500	421-446	394-419	358-392	331-356	322-329	277-320	250-275	214-248	187-212	185

① “T” numbers are for Groups E and F only.

② Mercury vapor and metal halide luminaires are not available for purchase within the United States. Please check with your countries governing legislation regarding allowable lamp types before ordering.

Mercmaster™ III Low Profile Luminaires

Class I, Zone 2; Ex nR IIC; IP66; NEMA 4X

Temperature identification numbers of Mercmaster III Zone 2 Low Profile High Pressure Sodium and Pulse Start Metal Halide.

CEC:
 Class I, Division 2, Groups A, B, C, D
 Class I, Zone 2 Ex nR IIC (Z)
 Class II, Division 1 and 2, Groups E, F, G
 Class III

CEC:
 Type 4X
 IP66

Watts	Lamp Type	Supply Wire Temp. °C (°F)	Ambient Temp. °C (°F)	Class I, Zone 2 AEx nA nR IIC / Ex nR IIC		
				Globe	Globe w/Reflector	Refractor
50	HPS	90 °C (194 °F)	40 °C (104 °F)	T6	T6	T6
		90 °C (194 °F)	55 °C (131 °F)	T5	T5	T5
		90 °C (194 °F)	65 °C (149 °F)	T4	T4	T5
70	HPS	90 °C (194 °F)	40 °C (104 °F)	T5	T5	T5
		90 °C (194 °F)	55 °C (131 °F)	T4	T4	T4
		90 °C (194 °F)	65 °C (149 °F)	—	—	T4
100	HPS	90 °C (194 °F)	40 °C (104 °F)	T4	T4	T4
		90 °C (194 °F)	55 °C (131 °F)	T4	T4	T4
150	HPS	90 °C (194 °F)	40 °C (104 °F)	T4	T4	T4
50	PSMH	90 °C (194 °F)	40 °C (104 °F)	T5	T5	T6
		90 °C (194 °F)	55 °C (131 °F)	T5	T5	T6
		90 °C (194 °F)	65 °C (149 °F)	T4	T4	T5
70	PSMH	90 °C (194 °F)	40 °C (104 °F)	T5	T5	T6
		90 °C (194 °F)	55 °C (131 °F)	T4	T4	T6
		110 °C (230 °F)	65 °C (149 °F)	—	—	T4
100	PSMH	90 °C (194 °F)	40 °C (104 °F)	T4	T4	T6
		90 °C (194 °F)	55 °C (131 °F)	T4	T4	T4
150	PSMH	105 °C (221 °F)	40 °C (104 °F)	T3	T3	T4
175	PSMH	105 °C (221 °F)	40 °C (104 °F)	T3	T3	T4
175	MH ①	110 °C (230 °F)	40 °C (104 °F)	—	—	T3

“T” Numbers represent the maximum surface temperature for luminaires with Ex nR rating:

The “T” number is established by separately determining the maximum temperature of the globe surface and ballast compartment. The hotter of the two is taken to determine the “T” number for the overall fixture.

“T” Number	T1	T2	T3	T4	T5	T6
Temp. Range (°C)	301-450	201-300	136-200	101-135	86-100	85
Temp. Range (°F)	547-842	394-572	277-392	214-275	187-212	185

① Mercury vapor and metal halide luminaires are not available for purchase within the United States. Please check with your countries governing legislation regarding allowable lamp types before ordering.



Mercmaster™ III Low Profile Luminaires

50 W – 150 W HPS

High Power Factor (min. P.F. 90%). Medium base lamps.

CEC:
Class I, Division 2, Groups A, B, C, D
Class I, Zone 2 Ex nR IIC (Z)
Class II, Division 1 and 2, Groups E, F, G
Class III

CEC:
Type 4X
IP66

	Lamp Type	Lamp Watts	Hub Size (Inches)	Catalog Numbers ③④⑤		
				With Globe	With Type V 8" Refractor ②	
Pendant – One Hub, Rigid Mounting ①						
	HPS	50	3/4 1	MLAL502G1N MLAL503G1N	MLAL502J5N MLAL503J5N	
	HPS	70	3/4 1	MLAL702G1N MLAL703G1N	MLAL702J5N MLAL703J5N	
	HPS	100	3/4 1	MLAL102G1N MLAL103G1N	MLAL102J5N MLAL103J5N	
	Shown with Globe and Optional Guard	HPS	150	3/4	MLAL152G1N ⑥	MLAL152J5N ⑥
				1	MLAL153G1N ⑥	MLAL153J5N ⑥
Pendant Cone – One Hub, Rigid Mounting						
	HPS	50	3/4 1	MLDL502G1N MLDL503G1N	MLDL502J5N MLDL503J5N	
	HPS	70	3/4 1	MLDL702G1N MLDL703G1N	MLDL702J5N MLDL703J5N	
	HPS	100	3/4 1	MLDL102G1N MLDL103G1N	MLDL102J5N MLDL103J5N	
	Shown with Refractor	HPS	150	3/4	MLDL152G1N ⑥	MLDL152J5N ⑥
				1	MLDL153G1N ⑥	MLDL153J5N ⑥
Ceiling – Five Hubs, Four Close-up Plugs						
	HPS	50	3/4 1	MLCL502G1N MLCL503G1N	MLCL502J5N MLCL503J5N	
	HPS	70	3/4 1	MLCL702G1N MLCL703G1N	MLCL702J5N MLCL703J5N	
	HPS	100	3/4 1	MLCL102G1N MLCL103G1N	MLCL102J5N MLCL103J5N	
	Shown with Globe	HPS	150	3/4	MLCL152G1N ⑥	MLCL152J5N ⑥
				1	MLCL153G1N ⑥	MLCL153J5N ⑥

① For Flexible Pendant Mount, change **A** to **F** in catalog number (except 50 W HPS).

② To order fixture with NEMA Type I or NEMA Type III refractor, change final digit **5** in catalog number to **1** or **3**.

③ For fixtures with guards, substitute a **G** for the **N** before adding voltage suffix. See following pages for accessory ordering information.

④ Add the following voltage and frequency designation before **Z** suffix:

Lamp Type	Lamp Watts	Voltage Suffixes						
		LB	MT	TT	C2	C3	C6	C7
Inc.	150 Max.	X	—	—	—	—	—	—
HPS	50	—	X	X	—	—	—	—
HPS	70	—	X	X	X	X	X	X
HPS	100	—	X	X	X	X	X	X
HPS	150	—	X	X	X	X	X	X
PSMH	50	—	X	X	—	—	—	—
PSMH	70	—	X	X	—	—	—	—
PSMH	100	—	X	X	—	—	—	—
PSMH	150	—	X	X	—	—	—	—
PSMH	175	—	X	X	—	—	—	—
MH ⑦	175	—	—	X	X	X	X	X

Voltages:

LB - Incandescent, 120 V 60 Hz

MT - 120/208/240/277 V 60 Hz

TT - 120/277/347 V 60 Hz, CWA

C2 - 208 V 60 Hz, CWI

C3 - 240 V 60 Hz, CWI

C6 - 480 V 60 Hz, CWI

C7 - 600 V 60 Hz, CWI

⑤ Add **Z** for factory sealed restricted breathing protection (Ex nR)

⑥ For 150 W HPS fixtures, use S-55 lamp type only.

⑦ Mercury vapor and metal halide luminaires are not available for purchase within the United States. Please check with your countries governing legislation regarding allowable lamp types before ordering.



Mercmaster™ III Low Profile Luminaires

50 W – 150 W HPS

High Power Factor (min. P.F. 90%). Medium base lamps.

CEC:
Class I, Division 2, Groups A, B, C, D
Class I, Zone 2 Ex nR IIC (Z)
Class II, Division 1 and 2, Groups E, F, G
Class III

CEC:
Type 4X
IP66

	Lamp Type	Lamp Watts	Hub Size (Inches)	Catalog Numbers ③④⑤	
				With Globe	With Type V 8" Refractor ②
Wall – Five Hubs, Four Close-Up Plugs					
	HPS	50	3/4 1	MLWL502G1N MLWL503G1N	MLWL502J5N MLWL503J5N
	HPS	70	3/4 1	MLWL702G1N MLWL703G1N	MLWL702J5N MLWL703J5N
	HPS	100	3/4 1	MLWL102G1N MLWL103G1N	MLWL102J5N MLWL103J5N
	HPS	150	3/4 1	MLWL152G1N ⑥ MLWL153G1N ⑥	MLWL152J5N ⑥ MLWL153J5N ⑥
Shown with Refractor and Optional Guard					
25° Stanchion – One Hub					
	HPS	50	1-1/4 1-1/2	MLSL504G1N MLSL505G1N	MLSL504J5N MLSL505J5N
	HPS	70	1-1/4 1-1/2	MLSL704G1N MLSL705G1N	MLSL704J5N MLSL705J5N
	HPS	100	1-1/4 1-1/2	MLSL104G1N MLSL105G1N	MLSL104J5N MLSL105J5N
	HPS	150	1-1/4 1-1/2	MLSL154G1N ⑥ MLSL155G1N ⑥	MLSL154J5N ⑥ MLSL155J5N ⑥
Shown with Globe and Optional Guard					
90° Stanchion – One Hub					
	HPS	50	1-1/4 1-1/2	MLRL504G1N MLRL505G1N	MLRL504J5N MLRL505J5N
	HPS	70	1-1/4 1-1/2	MLRL704G1N MLRL705G1N	MLRL704J5N MLRL705J5N
	HPS	100	1-1/4 1-1/2	MLRL104G1N MLRL105G1N	MLRL104J5N MLRL105J5N
	HPS	150	1-1/4 1-1/2	MLRL154G1N ⑥ MLRL155G1N ⑥	MLRL154J5N ⑥ MLRL155J5N ⑥
Shown with Refractor and Optional Guard					

② To order fixture with NEMA Type I or NEMA Type III refractor, change final digit 5 in catalog number to 1 or 3.

③ For fixtures with guards, substitute a G for the N before adding voltage suffix. See following pages for accessory ordering information.

④ Add the following voltage and frequency designation before Z suffix:

Lamp Type	Lamp Watts	Voltage Suffixes						
		LB	MT	TT	C2	C3	C6	C7
Inc.	150 Max.	X	—	—	—	—	—	—
HPS	50	—	X	X	—	—	—	—
HPS	70	—	X	X	X	X	X	X
HPS	100	—	X	X	X	X	X	X
HPS	150	—	X	X	X	X	X	X
PSMH	50	—	X	X	—	—	—	—
PSMH	70	—	X	X	—	—	—	—
PSMH	100	—	X	X	—	—	—	—
PSMH	150	—	X	X	—	—	—	—
PSMH	175	—	X	X	—	—	—	—
MH ⑦	175	—	—	X	X	X	X	X

Voltages:

LB - Incandescent, 120 V 60 Hz

MT - 120/208/240/277 V 60 Hz

TT - 120/277/347 V 60 Hz, CWA

C2 - 208 V 60 Hz, CWI

C3 - 240 V 60 Hz, CWI

C6 - 480 V 60 Hz, CWI

C7 - 600 V 60 Hz, CWI

⑤ Add Z for factory sealed restricted breathing protection (Ex nR)

⑥ For 150 W HPS fixtures, use S-55 lamp type only.

⑦ Mercury vapor and metal halide luminaires are not available for purchase within the United States. Please check with your countries governing legislation regarding allowable lamp types before ordering.



Mercmaster™ III Low Profile Luminaires

50 W - 175 W PSMH

High Power Factor (min. P.F. 90%). Medium base lamps.

CEC:
Class I, Division 2, Groups A, B, C, D
Class I, Zone 2 Ex nR IIC (Z)
Class II, Division 1 and 2, Groups E, F, G
Class III

CEC:
Type 4X
IP66

	Lamp Type	Lamp Watts	Hub Size (Inches)	Catalog Numbers ③④⑤	
				With Globe	With Type V 8" Refractor ②
Pendant — One Hub, Rigid Mounting ①					
	PSMH	50	3/4 1	MLAH502G1N MLAH503G1N	MLAH502J5N MLAH503J5N
	PSMH	70	3/4 1	MLAH702G1N MLAH703G1N	MLAH702J5N MLAH703J5N
	PSMH	100	3/4 1	MLAH102G1N MLAH103G1N	MLAH102J5N MLAH103J5N
	PSMH	150	3/4 1	MLAP152G1N MLAP153G1N	MLAP152J5N MLAP153J5N
	PSMH	175	3/4 1	MLAP172G1N MLAP173G1N	MLAP172J5N MLAP173J5N
	Shown with Globe and Optional Guard				
Pendant Cone — One Hub, Rigid Mounting					
	PSMH	50	3/4 1	MLDH502G1N MLDH503G1N	MLDH502J5N MLDH503J5N
	PSMH	70	3/4 1	MLDH702G1N MLDH703G1N	MLDH702J5N MLDH703J5N
	PSMH	100	3/4 1	MLDH102G1N MLDH103G1N	MLDH102J5N MLDH103J5N
	PSMH	150	3/4 1	MLDP152G1N MLDP153G1N	MLDP152J5N MLDP153J5N
	PSMH	175	3/4 1	MLDP172G1N MLDP173G1N	MLDP172J5N MLDP173J5N
	Shown with Refractor				
Ceiling — Five Hubs, Four Close-up Plugs					
	PSMH	50	3/4 1	MLCH502G1N MLCH503G1N	MLCH502J5N MLCH503J5N
	PSMH	70	3/4 1	MLCH702G1N MLCH703G1N	MLCH702J5N MLCH703J5N
	PSMH	100	3/4 1	MLCH102G1N MLCH103G1N	MLCH102J5N MLCH103J5N
	PSMH	150	3/4 1	MLCP152G1N MLCP153G1N	MLCP152J5N MLCP153J5N
	PSMH	175	3/4 1	MLCP172G1N MLCP173G1N	MLCP172J5N MLCP173J5N
	Shown with Globe				

① For Flexible Pendant Mount, change **A** to **F** in catalog number (except 50 W HPS).

② To order fixture with NEMA Type I or NEMA Type III refractor, change final digit **5** in catalog number to **1** or **3**.

③ For fixtures with guards, substitute a **G** for the **N** before adding voltage suffix. See following pages for accessory ordering information.

④ Add the following voltage and frequency designation before **Z** suffix:

Lamp Type	Lamp Watts	Voltage Suffixes						
		LB	MT	TT	C2	C3	C6	C7
Inc.	150 Max.	X	—	—	—	—	—	—
HPS	50	—	X	X	—	—	—	—
HPS	70	—	X	X	X	X	X	X
HPS	100	—	X	X	X	X	X	X
HPS	150	—	X	X	X	X	X	X
PSMH	50	—	X	X	—	—	—	—
PSMH	70	—	X	X	—	—	—	—
PSMH	100	—	X	X	—	—	—	—
PSMH	150	—	X	X	—	—	—	—
PSMH	175	—	X	X	—	—	—	—
MH ⑥	175	—	—	X	X	X	X	X

Voltages:

LB - Incandescent, 120 V 60 Hz

MT - 120/208/240/277 V 60 Hz

TT - 120/277/347 V 60 Hz, CWA

C2 - 208 V 60 Hz, CWI

C3 - 240 V 60 Hz, CWI

C6 - 480 V 60 Hz, CWI

C7 - 600 V 60 Hz, CWI

⑤ Add **Z** for factory sealed restricted breathing protection (Ex nR).

⑥ Mercury vapor and metal halide luminaires are not available for purchase within the United States. Please check with your countries governing legislation regarding allowable lamp types before ordering.



Mercmaster™ III Low Profile Luminaires

50 W - 175 W PSMH

High Power Factor (min. P.F. 90%). Medium base lamps.

CEC:
Class I, Division 2, Groups A, B, C, D
Class I, Zone 2 Ex nR IIC (Z)
Class II, Division 1 and 2, Groups E, F, G
Class III

CEC:
Type 4X
IP66

	Lamp Type	Lamp Watts	Hub Size (Inches)	Catalog Numbers ③④⑤	
				With Globe	With Type V 8" Refractor ②
Wall — Five Hubs, Four Close-Up Plugs					
	PSMH	50	3/4 1	MLWH502G1N MLWH503G1N	MLWH502J5N MLWH503J5N
	PSMH	70	3/4 1	MLWH702G1N MLWH703G1N	MLWH702J5N MLWH703J5N
	PSMH	100	3/4 1	MLWH102G1N MLWH103G1N	MLWH102J5N MLWH103J5N
	PSMH	150	3/4 1	MLWP152G1N MLWP153G1N	MLWP152J5N MLWP153J5N
	Shown with Refractor and Optional Guard	PSMH	175	3/4 1	MLWP172G1N MLWP173G1N
25° Stanchion — One Hub					
	PSMH	50	1-1/4 1-1/2	MLSH504G1N MLSH505G1N	MLSH504J5N MLSH505J5N
	PSMH	70	1-1/4 1-1/2	MLSH704G1N MLSH705G1N	MLSH704J5N MLSH705J5N
	PSMH	100	1-1/4 1-1/2	MLSH104G1N MLSH105G1N	MLSH104J5N MLSH105J5N
	PSMH	150	1-1/4 1-1/2	MLSP154G1N MLSP155G1N	MLSP154J5N MLSP155J5N
	Shown with Globe and Optional Guard	PSMH	175	1-1/4 1-1/2	MLSP174G1N MLSP175G1N
90° Stanchion — One Hub					
	PSMH	50	1-1/4 1-1/2	MLRH504G1N MLRH505G1N	MLRH504J5N MLRH505J5N
	PSMH	70	1-1/4 1-1/2	MLRH704G1N MLRH705G1N	MLRH704J5N MLRH705J5N
	PSMH	100	1-1/4 1-1/2	MLRH104G1N MLRH105G1N	MLRH104J5N MLRH105J5N
	PSMH	150	1-1/4 1-1/2	MLRP154G1N MLRP155G1N	MLRP154J5N MLRP155J5N
	Shown with Refractor and Optional Guard	PSMH	175	1-1/4 1-1/2	MLRP174G1N MLRP175G1N

② To order fixture with NEMA Type I or NEMA Type III refractor, change final digit 5 in catalog number to 1 or 3.

③ For fixtures with guards, substitute a G for the N before adding voltage suffix. See following pages for accessory ordering information.

④ Add the following voltage and frequency designation before Z suffix:

Lamp Type	Lamp Watts	LB	MT	TT	Voltage Suffixes			
					C2	C3	C6	C7
Inc.	150 Max.	X	—	—	—	—	—	—
HPS	50	—	X	X	—	—	—	—
HPS	70	—	X	X	X	X	X	X
HPS	100	—	X	X	X	X	X	X
HPS	150	—	X	X	X	X	X	X
PSMH	50	—	X	X	—	—	—	—
PSMH	70	—	X	X	—	—	—	—
PSMH	100	—	X	X	—	—	—	—
PSMH	150	—	X	X	—	—	—	—
PSMH	175	—	X	X	—	—	—	—
MH ⑥	175	—	—	X	X	X	X	X

Voltages:

LB - Incandescent, 120 V 60 Hz

MT - 120/208/240/277 V 60 Hz

TT - 120/277/347 V 60 Hz, CWA

C2 - 208 V 60 Hz, CWI

C3 - 240 V 60 Hz, CWI

C6 - 480 V 60 Hz, CWI

C7 - 600 V 60 Hz, CWI

⑤ Add Z for factory sealed restricted breathing protection (Ex nR).

⑥ Mercury vapor and metal halide luminaires are not available for purchase within the United States. Please check with your countries governing legislation regarding allowable lamp types before ordering.

Visit our website at www.emerson.com or contact us at (800) 621-1506.

© May 2016

Appleton

HD/AREA: NEG/CEC ENCLOSED AND GASKETED

207

EMERSON

Mercmaster™ III Low Profile Luminaires







High Pressure Sodium, Pulse Start Metal Halide and Metal Halide

Listed for simultaneous exposure to combustible dusts and flammable gases or vapors.

CEC:
 Class I, Division 2, Groups A, B, C, D
 Class I, Zone 2 Ex nR IIC (Z)
 Class II, Division 1 and 2, Groups E, F, G
 Class III

CEC:
 Type 4X
 IP66

Mounting Hoods

	Description	Hub Size (Inches)	Catalog Number
Pendant	 One Hub, Rigid Mounting	3/4	KPA-75
		1	KPA-100
Pendant – Flexible	 One Hub, Flexible Mounting	3/4	KPAF-75
		1	KPAF-100
Pendant Cone	 One Hub, Rigid or Flexible Mounting	3/4	KPCH-75
		1	KPCH-100
Ceiling	 Five Hubs, Four Close-Up Plugs	3/4	KPC-75
		1	KPC-100
Wall	 Five Hubs, Four Close-Up Plugs	3/4	KPWB-75
		1	KPWB-100
25° Stanchion	 One Hub	1-1/4	KPS-125
		1-1/2	KPS-150
90° Stanchion	 One Hub	1-1/4	KPST-125
		1-1/2	KPST-150

Fuse Kits – Order one kit for CWA ballasts and two kits for CWI ballasts ①

Volts	35W		50W		60W		70W		75W		100W		150W		175W	
	CWA	CWI	CWA	CWI	CWA	CWI	CWA	CWI	CWA	CWI	CWA	CWI	CWA	CWI	CWA	CWI
High Pressure Sodium																
120	F2C	F2C	F2C	F2C	—	—	F3C	F3C	—	—	F4C	F4C	F6C	F6C	—	—
208	—	—	—	F2C	—	—	—	F2C	—	—	—	F2C	—	—	F3C	—
240	F1C	F1C	F2C	F2C	—	—	F2C	F2C	—	—	F2C	F2C	F3C	F3C	—	—
277	F1C	—	F1C	—	—	—	F2C	—	—	—	F2C	—	F3C	—	—	—
347	F1C	—	F1C	—	—	—	F1C	—	—	—	F1C	—	F2C	—	—	—
480	—	—	—	F1C	—	—	—	F1C	—	—	—	F1C	—	F2C	—	—
600	—	—	—	F1C	—	—	—	F1C	—	—	—	F1C	—	F2C	—	—
Pulse Start Metal Halide/Metal Halide																
120	—	—	F3C	F3C	—	—	F4C	—	—	—	F4C	—	—	—	F6C	F6C
208	—	—	—	F2C	—	—	—	—	—	—	—	—	—	—	—	F4C
240	—	—	F1C	F1C	—	—	F2C	—	—	—	F2C	—	—	—	F3C	F3C
277	—	—	F1C	—	—	—	F2C	—	—	—	F2C	—	—	—	F3C	—
347	—	—	F1C	—	—	—	F2C	—	—	—	F2C	—	—	—	F2C	—
480	—	—	—	—	—	—	—	—	—	—	—	—	—	—	—	F2C
600	—	—	—	—	—	—	—	—	—	—	—	—	—	—	—	F2C
Incandescent																
—	—	—	—	—	—	F1C	—	—	—	—	F1C	—	F2C	—	—	—

① Not for use in Hazardous Location applications, per the Canadian Electrical Code (CEC).

Mercmaster™ III Low Profile Luminaires

High Pressure Sodium, Pulse Start Metal Halide and Metal Halide

Listed for simultaneous exposure to combustible dusts and flammable gases or vapors.

CEC:

Class I, Division 2, Groups A, B, C, D
 Class I, Zone 2 Ex nR IIC (Z)
 Class II, Division 1 and 2, Groups E, F, G
 Class III

CEC:

Type 4X
 IP66

Ballast Bodies



Ballast Body for Glass Refractor

High Pressure Sodium
 High Power Factor (Min. P.F. 90%)



Ballast Body for Glass Globe or Polymeric Refractor

Pulse Start Metal Halide
 Super Constant Wattage Autotransformer (Min. P.F. 90%)

Lamp Type	Lamp Watts	Catalog Number ④		Voltage Suffixes						
		For Globe	For Refractor	LB	MT	TT	C2	C3	C6	C7
Inc.	150 Max.	MLBG15I	MLBR15I	X	—	—	—	—	—	—
HPS	50	MLBG50L ①②	MLBR50L ①②	—	X	X	—	—	—	—
HPS	70	MLBG70L ①②	MLBR70L ①②	—	X	X	X	X	X	X
HPS	100	MLBG10L ①②	MLBR10L ①②	—	X	X	X	X	X	X
HPS	150	MLBG15L ①②	MLBR15L ①②	—	X	X	X	X	X	X
PSMH	50	MLBG50H ②③	MLBR50H ②③	—	X	X	—	—	—	—
PSMH	70	MLBG70H ②③	MLBR70H ②③	—	X	X	—	—	—	—
PSMH	100	MLBG10H ②③	MLBR10H ②③	—	X	X	—	—	—	—
PSMH	150	MLBG15P ②③	MLBR15P ②③	—	X	X	—	—	—	—
PSMH	175	MLBG17P ②③	MLBR17P ②③	—	X	X	—	—	—	—
MH ⑤	175	MLBG17H ②	MLBR17H ②	—	X	X	X	X	X	X

Voltages:

LB - Incandescent, 120 V 60 Hz
MT - 120/208/240/277 V 60 Hz
TT - 120/277/347 V 60 Hz, CWA
C2 - 208 V 60 Hz, CWI
C3 - 240 V 60 Hz, CWI
C6 - 480 V 60 Hz, CWI
C7 - 600 V 60 Hz, CWI

① After voltage suffix add: **-S** for Smart Starter, **-R** for ballast body with Hot Restrike Ignitor.

② Add **-E** after voltage suffix for ballast body with provision for Quartz Emergency Light. Not suitable for hazardous locations. Specify supply voltage.

③ After voltage suffix add: **-S** for Smart Starter.

④ Add **Z** for factory sealed restricted breathing protection (Ex nR).

⑤ Mercury vapor and metal halide luminaires are not available for purchase within the United States. Please check with your countries governing legislation regarding allowable lamp types before ordering.

Mercmaster™ III Low Profile Luminaires

High Pressure Sodium, Pulse Start Metal Halide and Metal Halide

Listed for simultaneous exposure to combustible dusts and flammable gases or vapors.

CEC:
 Class I, Division 2, Groups A, B, C, D
 Class I, Zone 2 Ex nR IIC (Z)
 Class II, Division 1 and 2, Groups E, F, G
 Class III

CEC:
 Type 4X
 IP66

Accessories and Replacement Parts

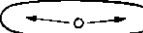
		Description	Catalog Number
Prismatic Glass Globes — Heat-Resistant			
 Glass Globe		Clear	VPGL-1HR
		Amber	VPGL-1AM
		Blue	VPGL-1BL
		Green	VPGL-1GR
		Red	VPGL-1RE
		Light Distribution	IES/NEMA Distribution Curves
Closed Prismatic Glass Refractors — All Heat-Resistant			
 Glass Refractor	NEMA Type I		LPG-R1
	NEMA Type III		LPG-R3
	NEMA Type V		LPG-R5
Closed Prismatic Polymeric Refractors — For Use with PSMH Lamps			
<i>100 W max. +40 °C (+104 °F) max. ambient temperature. Suitable for Class II, Division 1 and 2, Groups F, G; NEMA 4X, UL 1598A Marine Type Electric Fixtures Outside Type (Salt Water)</i>			
 Polymeric Refractor	NEMA Type II		LPRF-2CP
	NEMA Type III		LPRF-3CP
	NEMA Type IV		LPRF-4CP
	NEMA Type V		LPRF-5CP
		Description	Catalog Number
White Polyester Reflectors			
 Standard Dome	For Globe Fixtures	Standard Dome	KR2-ST
		Deep Dome	KR2-DD ①
		30° Angle	KR2-AN
 30° Angle	For Glass Refractor Fixtures	Standard Dome	CMR-4ST ②
		Deep Dome	CMR-4DD ①
		30° Angle	CMR-4AN
Guards			
 Globe Guard	 Refractor Guard	Globe Guard	KGU1
		Refractor Guard	KRG2
Replacement Globe Gaskets — Silicone Rubber			
 Globe Gaskets		Globe Gasket	VPGL-GK
		Refractor Gasket	KRF-GK

① Dark Skies Compliant.

② Standard and deep dome reflectors may interfere with bottom conduit entry if used with KPST and KPWB mounting hoods.

Mercmaster™ III Low Profile Luminaires

High Pressure Sodium, Pulse Start Metal Halide and Metal Halide

Listed for simultaneous exposure to combustible dusts and flammable gases or vapors.

CEC:
 Class I, Division 2, Groups A, B, C, D
 Class I, Zone 2 Ex nR IIC (Z)
 Class II, Division 1 and 2, Groups E, F, G
 Class III

CEC:
 Type 4X
 IP66

Electrical Specifications

Line Voltage	Type of Ballast ①	Starting Amps	Operating Amps	Total Watts
50 Watt High Pressure Sodium				
120	HX-HPF	0.58	0.58	64
208	HX-HPF	0.35	0.33	64
240	HX-HPF	0.31	0.29	64
277	HX-HPF	0.25	0.25	64
347	HX-HPF	0.26	0.21	68
70 Watt High Pressure Sodium				
120	HX-HPF	0.90	0.82	94
208	HX-HPF	0.50	0.48	94
240	HX-HPF	0.44	0.41	94
277	HX-HPF	0.35	0.36	94
347	HX-HPF	0.30	0.30	94
480	HX-HPF	0.21	0.21	94
100 Watt High Pressure Sodium				
120	HX-HPF	1.30	1.15	130
208	HX-HPF	0.76	0.67	130
240	HX-HPF	0.66	0.60	130
277	HX-HPF	0.60	0.52	130
347	HX-HPF	0.45	0.39	130
480	HX-HPF	0.33	0.31	135
480	C.W.I.	0.17	0.30	130
600	C.W.I.	0.14	0.24	130
150 Watt High Pressure Sodium ②				
120	HX-HPF	2.00	1.70	188
208	HX-HPF	1.15	0.95	188
240	HX-HPF	1.00	0.85	188
277	HX-HPF	0.85	0.72	188
347	HX-HPF	0.52	0.56	188
480	HX-HPF	0.50	0.47	189
480	C.W.I.	0.25	0.42	190
600	C.W.I.	0.19	0.35	190
50 Watt Pulse Start Metal Halide				
120	HX-HPF	0.87	0.62	67
208	HX-HPF	0.51	0.40	67
240	HX-HPF	0.47	0.35	67
277	HX-HPF	0.32	0.32	67
347	HX-HPF	0.15	0.20	67

Electrical Specifications

Line Voltage	Type of Ballast ①	Starting Amps	Operating Amps	Total Watts
70 Watt Pulse Start Metal Halide				
120	HX-HPF	0.80	0.85	95
208	HX-HPF	0.50	0.52	95
240	HX-HPF	0.43	0.44	95
277	HX-HPF	0.39	0.39	95
347	HX-HPF	0.20	0.28	88
480	HX-HPF	0.26	0.23	95
100 Watt Pulse Start Metal Halide				
120	HX-HPF	1.20	1.15	130
208	HX-HPF	0.70	0.70	130
240	HX-HPF	0.61	0.58	130
277	HX-HPF	0.55	0.50	130
347	HX-HPF	0.40	0.40	129
480	HX-HPF	0.30	0.35	140
150 Watt Pulse Start Metal Halide				
120	HX-HPF	1.75	1.60	188
208	HX-HPF	1.30	1.00	188
240	HX-HPF	0.85	0.80	188
277	HX-HPF	0.77	0.70	188
347	Super C.W.A.	0.65	0.55	185
480	Super C.W.A.	0.45	0.42	185
175 Watt Pulse Start Metal Halide				
120	Super C.W.A.	0.90	1.78	199
208	Super C.W.A.	0.50	1.08	199
240	Super C.W.A.	0.35	0.89	199
277	Super C.W.A.	0.30	0.76	199
347	Super C.W.A.	0.25	0.65	208
480	Super C.W.A.	0.25	0.50	213
175 Watt Metal Halide ③				
120	C.W.A.	1.30	1.80	210
208	C.W.A.	0.75	1.04	210
240	C.W.A.	0.65	0.90	210
277	C.W.A.	0.55	0.80	210
347	C.W.A.	0.50	0.65	210
480	C.W.I.	0.20	0.45	215
600	C.W.I.	0.16	0.37	215

① C.W.A. – Constant Wattage Autotransformer. HX-HPF – High Reactance High Power Factor Autotransformer. Super C.W.A. – Super Constant Wattage Autotransformer.

② 150 W HPS units equipped with ballasts to operate 55 V lamps only.

③ Mercury vapor and metal halide luminaires are not available for purchase within the United States. Please check with your countries governing legislation regarding allowable lamp types before ordering.

Mercmaster™ III Low Profile Luminaires

High Pressure Sodium, Pulse Start Metal Halide and Metal Halide

Listed for simultaneous exposure to combustible dusts and flammable gases or vapors.

CEC:
 Class I, Division 2, Groups A, B, C, D
 Class I, Zone 2 Ex nR IIC (Z)
 Class II, Division 1 and 2, Groups E, F, G
 Class III

CEC:
 Type 4X
 IP66

Dimensions in Millimeters (Inches)

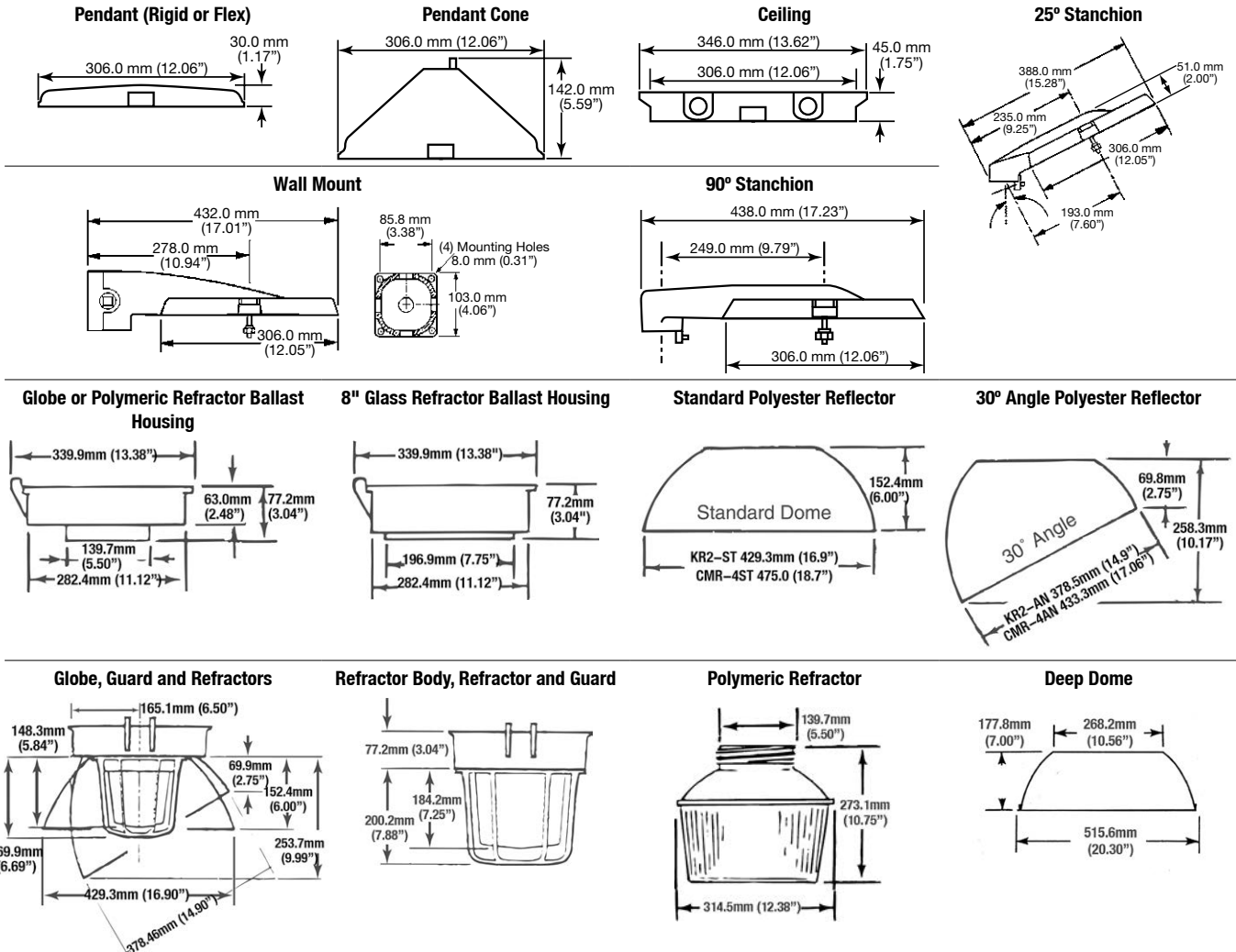

Mercmaster III Low Profile Ballast and Accessory Weights ①

Watts	Globe Housing Ballast Wt. kg (lb)		Refractor Housing Ballast Wt. kg (lb)		Mounting Hoods	Wt. Kg (Lb)	Refractors, Globes, Guards and Reflectors	Wt. Kg (Lb)
	HPS	PSMH	HPS	PSMH				
50	3.3 (7.28)	3.2 (7.05)	3.5 (7.72)	3.4 (7.50)	Pendant	1.0 (2.20)	8" Glass Refractor	2.4 (5.29)
70	3.7 (8.16)	3.5 (7.72)	4.0 (8.82)	3.7 (8.16)	Pendant Cone	1.1 (2.43)	Glass Globe	1.7 (3.75)
100	4.4 (9.70)	4.2 (9.26)	4.6 (10.14)	4.4 (9.70)	Ceiling	1.4 (3.09)	Refractor Guard	0.5 (1.10)
150	4.9 (10.80)	4.9 (10.80)	5.1 (11.24)	5.1 (11.24)	Wall	1.8 (3.97)	Globe Guard	0.5 (1.10)
175	—	5.0 (11.02)	—	5.2 (11.46)	25° Stanchion	1.5 (3.31)	Standard Dome	1.1 (2.43)
					90° Stanchion	1.7 (3.75)	Deep Dome	2.3 (5.07)
							30° Angle	1.1 (2.43)
							Polymeric Refractor	1.1 (2.43)

① Weights are approximate. Add 0.1 kg (0.25 lbs) for Quartz option.

PCD2 Series Factory Sealed Hazardous Location Photocontrol

For use in Class I, Division 2, Groups A, B, C, D locations

Maintains Class I, Division 2 rating for Mercmaster III – Low Profile, Mercmaster III, and Mercmaster III – 400 Series Luminaires, Mercmaster LED

NEC/CEC:
Class I, Division 2, Groups A, B, C, D
NEMA 4X

Applications

- Encapsulated photocontrol provides automatic dusk-to-dawn lighting control in Class I, Division 2 locations.
- Typical applications include walkways, security areas and any other outdoor lighting application.
- For use with Mercmaster III – Low Profile, Mercmaster III, and Mercmaster III – 400 Series Luminaires.
- For remote mounting in FS Boxes.

- 50-400 W HID, incandescent or fluorescent, 50/60 Hz.
- 1000 V.A. Voltage/Ampere
- Minimum time delay: 15 seconds to eliminate nuisance tripping.
- Provided with (3) 18 AWG stranded leads 152.4 mm (6.00 in) in length.
- Will fit through standard 1/2" knockout.
- Supplied with locknut and gasket.

Features



- Factory sealed design eliminates the need for an explosionproof enclosure.
- Can be easily installed in the field.
- Solid state design for performance and reliability.
- Available for 120, 208, 240, or 277 volts.

Materials

- Encapsulated with epoxy sealing compound
- FS: aluminum

NEC/CEC Certifications and Compliances

- UL Standard: 1604 – Hazardous (Classified) Locations
- cULus Recognized

	Voltage Range	Max VA	Max Current Amps	Suffix Designation Catalog Number
Factory-Installed Photocontrol - Not for ceiling or pendant cone.				
<i>Add to fixture catalog after voltage; i.e.: KPWBL1075MTH1.</i>				
	120 V, 50/60 Hz	1000	—	H1
	208 V, 50/60 Hz	1000	—	H2
	240 V, 50/60 Hz	1000	—	H3
	277 V, 50/60 Hz	1000	—	H4
Photocontrol for Field Installation				
	120 V, 50/60 Hz	1000	8.3 Amp	PC120D2
	208 V, 50/60 Hz	1000	4.8 Amp	PC247D2
	240 V, 50/60 Hz	1000	4.2 Amp	
	277 V, 50/60 Hz	1000	3.6 Amp	
Photocontrol in FS Cover for Use with FS/FD Box				
<i>Supplied with two stainless steel screws. For neoprene gasket, order catalog number FS-GKR-1N.</i>				
	120 V, 50/60 Hz	1000	8.3 Amp	FSKA-PC120D2
	208, 50/60 Hz	1000	4.8 Amp	FSKA-PC247D2
	240 V, 50/60 Hz	1000	4.2 Amp	
	277 V, 50/60 Hz	1000	3.6 Amp	

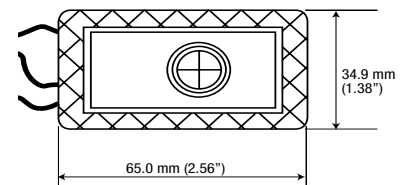
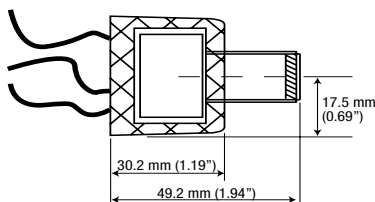
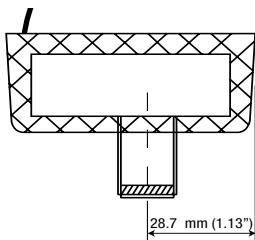

Mercmaster™ III Low Profile Luminaires

150 W HPS

* Photometric data is based on a fixture with a 150-watt clear High Pressure Sodium lamp (16,000 lumen). For candlepower values of fixtures with other HPS lamps, use the following multipliers: for a 100 W (9,500 lumen) HPS lamp – 0.594; for a 70 W (6,400 lumen) HPS lamp – 0.40; for a 50 W (4,000 lumen) HPS lamp – 0.25. For candlepower values of fixture with guard, multiply by – 0.95.

CEC:
 Class I, Division 2, Groups A, B, C, D
 Class I, Zone 2 Ex nR IIC (Z)
 Class II, Division 1 and 2, Groups E, F, G
 Class III

CEC:
 Type 4X
 IP66

Photometric Data

Zone	Lumens	Total Luminaire Efficiency = 83%											
0-10	28.58	CIE Type – Semi-Direct											
10-20	123.97	<table border="1"> <thead> <tr> <th>Plane</th> <th>Spacing Criteria</th> </tr> </thead> <tbody> <tr> <td>0-180</td> <td>3.9</td> </tr> <tr> <td>90-270</td> <td>3.9</td> </tr> <tr> <td>Diagonal</td> <td>3.7</td> </tr> </tbody> </table>				Plane	Spacing Criteria	0-180	3.9	90-270	3.9	Diagonal	3.7
Plane	Spacing Criteria												
0-180	3.9												
90-270	3.9												
Diagonal	3.7												
20-30	304.16												
30-40	513.64												
40-50	889.19												
50-60	1299.53												
60-70	1506.73												
70-80	1706.16	Zonal Lumen Summary											
80-90	1800.53	Zone	Lumens	% Lamp	% Fixture								
90-100	1791.58	0-30	4563.72	2.9	3.4								
100-110	1652.69	0-40	970.35	6.1	7.3								
110-120	1311.22	0-60	3159.07	19.7	23.8								
120-130	351.25	0-90	8172.49	51.1	61.5								
130-140	5.14	90-120	4755.49	29.7	35.8								
140-150	0.00	90-130	5106.74	31.9	38.4								
150-160	0.00	90-150	5111.87	31.9	38.4								
160-170	0.00	90-180	5111.87	31.9	38.5								
170-180	0.00	0-180	13284.37	83.0	100.0								

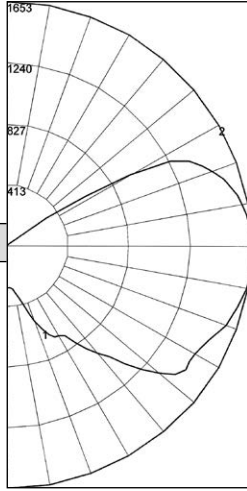

REPORT NUMBER: **ML15LG**

Lamps: 150 W High Pressure Sodium with Globe only *

Coefficients of Utilization – Zonal Cavity Method

Effective Floor Cavity Reflectance 0.20

% Ceiling Rcc	80	70				50				30				10				0	
		70	50	30	10	70	50	30	10	50	30	10	50	30	10				
% Walls	Rw	70	50	30	10	70	50	30	10	50	30	10	50	30	10	50	30	10	0
0	91	91	91	91	85	85	85	85	75	75	75	65	65	65	55	55	55	51	
1	77	71	66	61	72	66	61	57	57	53	49	48	45	42	40	37	35	31	
2	68	59	51	45	63	55	48	42	46	41	36	39	34	31	32	28	25	21	
3	61	50	42	35	56	46	39	33	39	33	28	32	27	23	26	22	19	16	
4	55	43	35	28	50	40	32	26	34	27	22	28	23	18	22	18	15	12	
5	50	38	29	23	46	35	27	21	29	23	18	24	19	15	19	15	12	9	
6	46	33	25	19	42	31	23	18	26	20	15	21	16	12	17	13	10	7	
7	42	30	22	16	38	27	20	15	23	17	13	19	14	10	15	11	8	6	
8	39	27	19	14	36	25	18	13	21	15	11	17	12	9	14	10	7	5	
9	36	24	17	12	33	22	16	11	19	13	9	16	11	8	13	9	6	4	
10	33	22	15	11	31	20	14	10	17	12	8	15	10	7	12	8	5	4	

Zone	Lumens	Total Luminaire Efficiency = 73.2%											
0-10	219.96	CIE Type – Direct											
10-20	683.41	<table border="1"> <thead> <tr> <th>Plane</th> <th>Spacing Criteria</th> </tr> </thead> <tbody> <tr> <td>0-180</td> <td>1.64</td> </tr> <tr> <td>90-270</td> <td>1.64</td> </tr> <tr> <td>Diagonal</td> <td>1.88</td> </tr> </tbody> </table>				Plane	Spacing Criteria	0-180	1.64	90-270	1.64	Diagonal	1.88
Plane	Spacing Criteria												
0-180	1.64												
90-270	1.64												
Diagonal	1.88												
20-30	1267.92												
30-40	1613.68												
40-50	1967.79												
50-60	2333.86												
60-70	2328.33												
70-80	1118.52	Zonal Lumen Summary											
80-90	174.91	Zone	Lumens	% Lamp	% Fixture								
90-100	1.23	0-30	2171.29	13.6	18.5								
100-110	0.00	0-40	3784.97	23.7	32.3								
110-120	0.00	0-60	8086.62	50.5	69.1								
120-130	0.00	0-90	11708.37	73.2	100.0								
130-140	0.00	90-120	1.23	0.0	0.0								
140-150	0.00	90-130	1.23	0.0	0.0								
150-160	0.00	90-150	1.23	0.0	0.0								
160-170	0.00	90-180	1.23	0.0	0.0								
170-180	0.00	0-180	11709.6	73.2	100.0								

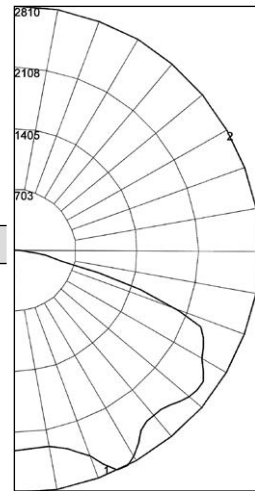

REPORT NUMBER: **ML15LST**

Lamps: 150 W High Pressure Sodium with Standard Dome Reflector *

Coefficients of Utilization – Zonal Cavity Method

Effective Floor Cavity Reflectance 0.20

% Ceiling Rcc	80	70				50				30				10				0	
		70	50	30	10	70	50	30	10	50	30	10	50	30	10				
% Walls	Rw	70	50	30	10	70	50	30	10	50	30	10	50	30	10	50	30	10	0
0	87	87	87	87	85	85	85	85	81	81	81	78	78	78	75	75	75	73	
1	79	75	71	68	77	73	70	67	70	67	65	67	65	63	64	62	61	59	
2	70	63	58	53	68	62	57	52	59	55	51	57	53	50	55	52	49	47	
3	63	54	48	42	61	53	47	42	51	46	41	49	44	40	47	43	40	38	
4	57	47	40	35	55	46	39	34	44	38	34	42	37	33	41	36	33	31	
5	52	41	34	29	50	41	34	29	39	33	28	37	32	28	36	31	28	26	
6	48	37	30	24	46	36	29	24	35	29	24	33	28	24	32	27	24	22	
7	44	33	26	21	42	32	26	21	31	25	21	30	25	21	29	24	20	19	
8	41	30	23	18	39	29	23	18	28	22	18	27	22	18	26	22	18	16	
9	38	27	21	16	37	27	20	16	26	20	16	25	20	16	24	19	16	14	
10	35	25	19	15	34	24	18	14	24	18	14	23	18	14	22	18	14	13	

Mercmaster™ III Low Profile Luminaires

150 W HPS

* Photometric data is based on a fixture with a 150-watt clear High Pressure Sodium lamp (16,000 lumen). For candlepower values of fixtures with other HPS lamps, use the following multipliers: for a 100 W (9,500 lumen) HPS lamp – 0.594; for a 70 W (6,400 lumen) HPS lamp – 0.40; for a 50 W (4,000 lumen) HPS lamp – 0.25. For candlepower values of fixture with guard, multiply by – 0.95.

CEC:
 Class I, Division 2, Groups A, B, C, D
 Class I, Zone 2 Ex nR IIC (Z)
 Class II, Division 1 and 2, Groups E, F, G
 Class III

CEC:
 Type 4X
 IP66

Photometric Data

Zone	Lumens	Total Luminaire Efficiency = 68.4%			
0-10	168.01	CIE Type – Direct			
10-20	536.92	Plane	Spacing Criteria		
20-30	972.38				
30-40	1342.99	0-180	2.3		
40-50	1625.08	90-270	2.0		
50-60	1721.88	Diagonal	1.8		
60-70	1586.98				
70-80	1369.71	Zonal Lumen Summary			
80-90	995.76	Zone	Lumens	% Lamp	% Fixture
90-100	461.94	0-30	1677.30	10.5	15.3
100-110	127.24	0-40	3020.29	18.9	27.6
110-120	27.54	0-60	6367.25	39.8	58.2
120-130	4.31	0-90	10319.70	64.5	94.3
130-140	2.68	90-120	616.71	3.9	5.6
140-150	0.00	90-130	621.02	3.9	5.7
150-160	0.00	90-150	623.70	3.9	5.7
160-170	0.00	90-180	623.70	3.9	5.7
170-180	0.00	0-180	10943.41	68.4	100.0

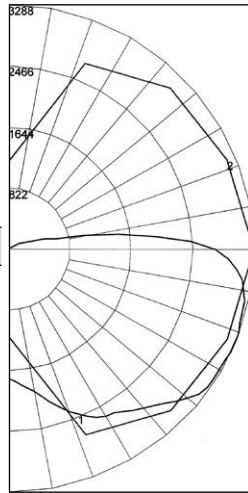

REPORT NUMBER: **ML15LAN**

Lamps: 150 W High Pressure Sodium with
 30° Angle Dome Reflector *

Coefficients of Utilization – Zonal Cavity Method

Effective Floor Cavity Reflectance 0.20

% Ceiling Rcc	Rw	80		70		50		30		10		0						
		70	50	30	10	70	50	30	10	50	30	10	0					
0	80	80	80	80	78	78	78	78	74	74	74	70	70	70	66	66	66	64
1	70	66	62	58	68	64	60	57	60	57	54	57	54	52	54	52	50	48
2	63	56	50	45	60	54	49	44	51	46	42	48	44	41	45	42	39	37
3	56	48	41	36	54	46	40	35	44	38	34	41	37	33	39	35	32	30
4	51	42	35	29	49	40	34	29	38	32	28	36	31	27	34	30	26	24
5	47	37	30	24	45	36	29	24	34	28	23	32	27	23	30	26	22	20
6	43	33	26	21	41	32	25	20	30	24	20	28	23	19	27	22	19	17
7	39	29	23	18	38	28	22	18	27	21	17	26	21	17	24	20	16	15
8	37	26	20	16	35	26	20	15	24	19	15	23	18	15	22	18	14	13
9	34	24	18	14	33	23	18	14	22	17	13	21	17	13	20	16	13	11
10	32	22	16	12	31	22	16	12	21	15	12	20	15	12	19	15	11	10

Zone	Lumens	Total Luminaire Efficiency = 77.6%			
0-10	16.51	CIE Type – Semi-Direct			
10-20	135.03	Plane	Spacing Criteria		
20-30	274.24				
30-40	463.44	0-180	2.22		
40-50	1125.38	90-270	2.20		
50-60	1688.89	Diagonal	3.50		
60-70	3137.76				
70-80	2421.27	Zonal Lumen Summary			
80-90	1145.98	Zone	Lumens	% Lamp	% Fixture
90-100	411.16	0-30	425.77	2.7	3.4
100-110	632.32	0-40	889.22	5.6	7.2
110-120	448.30	0-60	3703.50	23.1	29.8
120-130	293.08	0-90	10408.50	65.1	83.8
130-140	154.61	90-120	1491.78	9.3	12.0
140-150	59.30	90-130	1784.86	11.2	14.4
150-160	9.99	90-150	1998.77	12.5	14.4
160-170	0.49	90-180	2009.26	12.6	16.2
170-180	0.00	0-180	12417.76	77.6	100.0

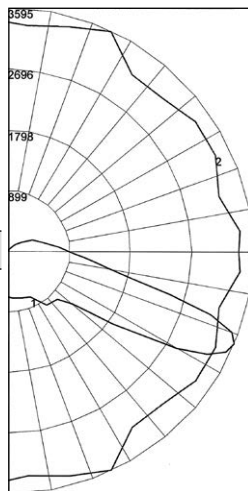

REPORT NUMBER: **ML15LJ5**

Lamps: 150 W High Pressure Sodium with
 8" Prismatic Glass Refractor – NEMA Type V *

Coefficients of Utilization – Zonal Cavity Method

Effective Floor Cavity Reflectance 0.20

% Ceiling Rcc	Rw	80		70		50		30		10		0						
		70	50	30	10	70	50	30	10	50	30	10	0					
0	89	89	89	89	86	86	86	86	79	79	79	73	73	73	68	68	68	65
1	76	70	65	60	72	67	62	58	61	57	54	56	53	50	51	48	46	43
2	66	56	49	42	62	54	47	41	49	43	38	44	39	35	40	36	32	29
3	58	46	38	31	54	44	36	30	40	33	27	36	30	25	32	27	23	21
4	51	39	30	23	48	37	29	22	33	26	21	30	24	19	27	22	17	15
5	46	34	25	18	43	32	24	18	29	22	16	26	20	15	23	18	13	11
6	42	29	21	15	40	28	20	14	25	18	13	22	16	12	20	15	11	8
7	39	26	18	12	36	25	17	12	22	15	11	20	14	10	18	13	9	7
8	36	23	15	10	33	22	15	10	20	13	9	18	12	8	16	11	7	5
9	33	21	14	9	31	20	13	8	18	12	8	16	11	7	15	10	6	4
10	31	19	12	8	29	18	12	7	17	11	7	15	10	6	13	9	5	4

Mercmaster™ III Low Profile Luminaires

100 W PSMH

* Photometric data is based on a fixture with a 100-watt clear Pulse Start Metal Halide lamp (8,500 lumen). For candlepower values of fixtures with other PSMH lamps, use the following multipliers: for a 50 W (3400 lumen) PSMH lamp – 0.40; for a 70 W (5600 lumen) PSMH lamp – 0.66; for a 150 W (10,500 lumen) PSMH lamp – 1.24; for a 175 W (17,500 lumen) PSMH lamp – 2.06. For candlepower values of fixture with guard, multiply by – 0.95.

CEC:
 Class I, Division 2, Groups A, B, C, D
 Class I, Zone 2 Ex nR IIC (Z)
 Class II, Division 1 and 2, Groups E, F, G
 Class III

CEC:
 Type 4X
 IP66

Photometric Data

Zone	Lumens	Total Luminaire Efficiency = 85.7%			
0-10	21.19	CIE Type – Semi-Direct			
10-20	93.55	Plane	Spacing Criteria		
20-30	201.68				
30-40	291.92	0-180	3.20		
40-50	523.42	90-270	3.20		
50-60	637.38	Diagonal	3.08		
60-70	732.34				
70-80	845.58	Zonal Lumen Summary			
80-90	874.42	Zone	Lumens	% Lamp	% Fixture
90-100	870.80	0-30	316.42	4.1	4.7
100-110	809.33	0-40	608.33	7.8	9.1
110-120	643.44	0-60	1769.13	22.7	26.5
120-130	139.00	0-90	4221.46	54.1	63.2
130-140	0.71	90-120	2323.56	29.8	34.8
140-150	0.00	90-130	2462.56	31.6	36.8
150-160	0.00	90-150	2463.27	31.6	36.8
160-170	0.00	90-180	2463.27	31.6	36.8
170-180	0.00	0-180	6684.73	85.7	100.0

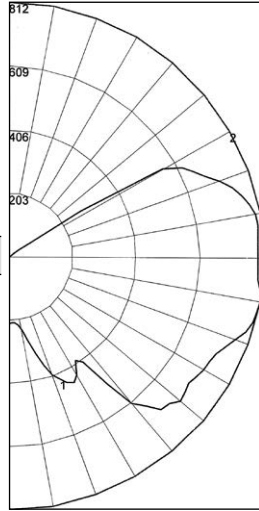

REPORT NUMBER: **ML10HG**

Lamps: 100 W Pulse Start Metal Halide with Globe only *

Coefficients of Utilization – Zonal Cavity Method

Effective Floor Cavity Reflectance 0.20

% Ceiling Rcc	% Walls R _w	80		70		50		30		10		0						
		70	50	30	10	70	50	30	10	50	30	10	0					
0	95	95	95	95	89	89	89	89	78	78	78	68	68	68	58	58	58	54
1	81	74	69	64	75	69	64	60	60	56	52	51	48	45	43	40	38	34
2	71	62	54	48	66	57	50	45	49	43	39	41	37	33	34	31	28	24
3	64	52	44	37	59	49	41	35	41	35	30	35	30	26	29	25	21	18
4	57	45	37	30	53	42	34	28	36	29	24	30	25	20	25	20	17	14
5	52	40	31	25	48	37	29	23	31	25	20	26	21	17	21	17	14	11
6	48	35	27	21	44	33	25	19	28	21	17	23	18	14	19	15	11	9
7	44	31	23	17	40	29	22	16	25	19	14	21	16	12	17	13	10	7
8	41	28	20	15	37	26	19	14	22	16	12	19	14	10	16	11	8	6
9	38	26	18	13	35	24	17	12	20	15	11	17	12	9	14	10	7	5
10	35	23	16	12	32	22	15	11	19	13	9	16	11	8	13	9	6	5

Zone	Lumens	Total Luminaire Efficiency = 75.8%			
0-10	116.29	CIE Type – Direct			
10-20	371.61	Plane	Spacing Criteria		
20-30	692.88				
30-40	821.73	0-180	1.70		
40-50	1064.03	90-270	1.70		
50-60	1154.58	Diagonal	1.84		
60-70	1134.19				
70-80	470.22	Zonal Lumen Summary			
80-90	83.66	Zone	Lumens	% Lamp	% Fixture
90-100	0.82	0-30	1180.78	15.1	20.0
100-110	0.00	0-40	2002.50	25.7	33.9
110-120	0.00	0-60	4221.11	54.1	71.4
120-130	0.00	0-90	5909.17	75.8	100.0
130-140	0.00	90-120	0.82	0.0	0.0
140-150	0.00	90-130	0.82	0.0	0.0
150-160	0.00	90-150	0.82	0.0	0.0
160-170	0.00	90-180	0.82	0.0	0.0
170-180	0.00	0-180	5910.00	75.8	100.0

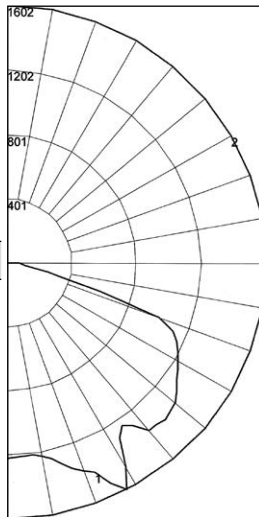

REPORT NUMBER: **ML10HST**

Lamps: 100 W Pulse Start Metal Halide with Standard Dome Reflector *

Coefficients of Utilization – Zonal Cavity Method

Effective Floor Cavity Reflectance 0.20

% Ceiling Rcc	% Walls R _w	80		70		50		30		10		0						
		70	50	30	10	70	50	30	10	50	30	10	0					
0	90	90	90	90	88	88	88	88	84	84	84	81	81	81	77	77	77	76
1	82	78	74	71	80	76	73	70	73	70	68	70	68	66	67	65	64	62
2	73	66	61	56	71	65	60	55	62	58	54	60	56	53	57	54	51	50
3	66	57	50	45	64	56	50	45	54	48	44	51	47	43	49	46	42	40
4	60	50	43	37	58	49	42	37	47	41	36	45	40	36	43	39	35	33
5	54	44	36	31	53	43	36	31	41	35	30	40	34	30	38	33	30	28
6	50	39	32	26	48	38	31	26	37	31	26	35	30	26	34	29	25	24
7	46	35	28	23	45	34	27	23	33	27	22	32	26	22	31	26	22	20
8	43	32	25	20	41	31	24	20	30	24	20	29	24	20	28	23	19	18
9	40	29	22	18	38	28	22	18	27	22	17	27	21	17	36	21	17	16
10	37	26	20	16	36	26	20	16	25	20	16	24	19	16	24	19	15	14

Mercmaster™ III Low Profile Luminaires

100 W PSMH

* Photometric data is based on a fixture with a 100-watt clear Pulse Start Metal Halide lamp (8,500 lumen). For candlepower values of fixtures with other PSMH lamps, use the following multipliers: for a 50 W (3400 lumen) PSMH lamp – 0.40; for a 70 W (5600 lumen) PSMH lamp – 0.66; for a 150 W (10,500 lumen) PSMH lamp – 1.24; for a 175 W (17,500 lumen) PSMH lamp – 2.06. For candlepower values of fixture with guard, multiply by – 0.95.

CEC:
 Class I, Division 2, Groups A, B, C, D
 Class I, Zone 2 Ex nR IIC (Z)
 Class II, Division 1 and 2, Groups E, F, G
 Class III

CEC:
 Type 4X
 IP66

Photometric Data

Zone Lumens Total Luminaire Efficiency = 71.3%

Zone	Lumens	CIE Type – Direct			
		Plane	Spacing Criteria		
0-10	91.83				
10-20	301.65				
20-30	543.23				
30-40	703.02	0-180	2.08		
40-50	877.11	90-270	2.06		
50-60	850.33	Diagonal	1.76		
60-70	7753.51				
70-80	667.27	Zonal Lumen Summary			
Zone	Lumens	% Lamp	% Fixture		
80-90	471.44				
90-100	200.90	0-30	936.72	12.0 16.8	
100-110	62.89	0-40	1639.74	21.0 29.5	
110-120	14.42	0-60	3367.18	43.2 60.6	
120-130	1.07	0-90	5281.39	67.7 95.0	
130-140	0.00	90-120	278.21	3.6 5.0	
140-150	0.00	90-130	279.28	3.6 5.0	
150-160	0.00	90-150	279.28	3.6 5.0	
160-170	0.00	90-180	279.28	3.6 5.0	
170-180	0.00	0-180	5560.68	71.3 100.0	

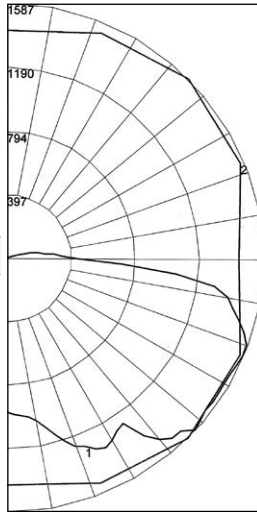

REPORT NUMBER: **ML10HAN**

Lamps: 100 W Pulse Start Metal Halide with
 30° Angle Dome Reflector *

Coefficients of Utilization – Zonal Cavity Method

Effective Floor Cavity Reflectance 0.20

% Ceiling Rcc	80						70						50						30						10						0					
	% Walls	Rw	70	50	30	10	70	50	30	10	50	30	10	50	30	10	50	30	10	50	30	10	0													
0	84	84	84	84	84	82	82	82	82	77	77	77	73	73	73	69	69	69	69	69	69	69	68													
1	74	69	65	62	71	67	64	60	63	60	58	60	57	55	57	55	53	51	57	55	53	51	51													
2	66	59	53	48	64	57	51	47	54	49	45	51	47	43	48	45	42	40	48	45	42	40	40													
3	59	51	44	38	57	49	43	38	46	41	36	44	39	35	41	37	34	32	41	37	34	32	32													
4	54	44	37	31	52	43	36	31	40	35	30	38	33	29	36	32	28	27	36	32	28	27	27													
5	49	39	32	26	47	38	31	26	36	30	25	34	29	25	32	28	24	22	34	29	25	24	22													
6	45	35	28	23	43	34	27	22	32	26	22	30	25	21	29	24	21	19	30	25	21	20	19													
7	42	31	24	20	40	30	24	19	29	23	19	27	22	18	26	22	18	16	27	22	18	16	16													
8	39	28	22	17	37	28	21	17	26	21	17	25	20	16	24	19	16	14	25	20	16	14	14													
9	36	26	19	15	35	25	19	15	24	19	15	23	18	14	22	17	14	13	23	18	14	13	13													
10	34	24	18	14	32	23	17	13	22	17	13	21	16	13	20	16	13	11	21	16	13	11	11													

Zone Lumens Total Luminaire Efficiency = 76.6%

Zone	Lumens	CIE Type – Semi-Direct			
		Plane	Spacing Criteria		
0-10	9.17				
10-20	75.43				
20-30	154.76				
30-40	266.34	0-180	2.06		
40-50	632.54	90-270	2.20		
50-60	1155.59	Diagonal	3.26		
60-70	1665.76				
70-80	693.73	Zonal Lumen Summary			
Zone	Lumens	% Lamp	% Fixture		
80-90	449.28				
90-100	177.44	0-30	239.35	3.1 4.0	
100-110	288.25	0-40	505.69	6.5 8.5	
110-120	208.52	0-60	2293.81	29.4 38.4	
120-130	128.19	0-90	5102.58	65.4 85.4	
130-140	56.80	90-120	674.20	8.6 11.3	
140-150	14.94	90-130	802.38	10.3 13.4	
150-160	0.10	90-150	874.12	11.2 13.4	
160-170	0.00	90-180	874.22	11.2 14.6	
170-180	0.00	0-180	5976.80	76.6 100.0	

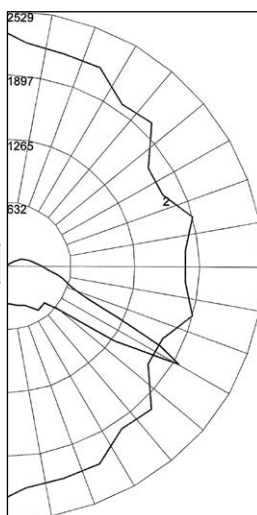

REPORT NUMBER: **ML10HJ5**

Lamps: 100 W Pulse Start Metal Halide with
 8" Prismatic Glass Refractor – NEMA Type V *

Coefficients of Utilization – Zonal Cavity Method

Effective Floor Cavity Reflectance 0.20

% Ceiling Rcc	80						70						50						30						10						0					
	% Walls	Rw	70	50	30	10	70	50	30	10	50	30	10	50	30	10	50	30	10	50	30	10	0													
0	89	89	89	89	85	85	85	85	79	79	79	73	73	73	68	68	68	65	73	73	73	68	68	65												
1	77	71	67	62	73	68	64	60	63	59	56	58	55	52	53	51	49	46	63	59	56	53	51	46												
2	67	58	51	45	64	56	49	44	51	46	41	47	42	38	43	39	36	33	51	46	41	39	36	33												
3	59	48	40	34	56	46	39	32	42	36	30	38	33	28	34	30	26	24	42	36	30	28	26	24												
4	52	41	32	26	49	39	31	25	35	28	23	32	26	21	29	24	20	18	35	28	23	22	20	18												
5	47	35	26	20	44	33	25	19	30	23	18	27	21	17	25	20	15	13	27	21	17	15	13	13												
6	43	30	22	16	40	29	21	15	26	19	14	24	18	13	21	16	12	10	24	18	13	12	10	10												
7	39	27	19	13	37	25	18	13	23	16	12	21	15	11	19	14	10	8	21	15	11	10	8	8												
8	36	24	16	11	34	23	15	10	21	14	10	19	13	9	17	12	8	6	19	13	9	12	8	6												
9	33	21	14	9	31	20	14	9	19	12	8	17	11	8	15	10	7	5	17	11	8	10	7	5												
10	31	19	12	8	29	19	12	8	17	11	7	15	10	6	14	9	6	4	15	10	6	9	6	4												

Mercmaster™ III HID 50–250 Watt Luminaires

High Pressure Sodium and Pulse Start Metal Halide

Listed for simultaneous exposure to combustible dusts and flammable gases or vapors.

NEC/CEC:

Class I, Division 2, Groups A, B, C, D
Class I, Zone 2, AEx nA nR IIC (Z2)
Class I, Zone 2, AEx nR IIC (ZB)
Class II, Division 1 and 2, Groups E, F, G
Class III

NEC/CEC:

Simultaneous Exposure (Class I, Division 2/
Class II, Division 1)
Fixtures Outside Type (Salt Water)
Type 4X
IP66

Applications

- Enclosed and gasketed fixtures suitable for use in:
 - Marine and wet locations
 - A wide range of industrial, chemical processing and other areas where flammable gases and vapors or combustible dusts are present under conditions defined by the National Electrical Code as Class I, Division 2; Class II, Division 1 and 2; and Class III
 - For Zone 2, the method of protection is AEx nA nR – Restricted Breathing/Nonsparking or AEx nR – Restricted Breathing
 - Non-hazardous locations where severe weather conditions, excessive moisture, dirt, dust, corrosive atmosphere or high ambient temperatures are encountered. 18% cooler operation allows use in ambient temperatures up to 65 °C (149 °F) depending on fixture component combinations
- Typical applications include:
 - Pulp and paper mills
 - Processing plants
 - Chemical plants
 - Oil refineries
 - Foundries
 - Manufacturing plants
 - Storage areas
 - Marine applications
- Fixtures have NEMA 4X listing.
- Suitability includes listing for use where there may be simultaneous exposure to combustible dusts and flammable gases and vapors. See listing pages for compliance data on specific fixture component combinations.

Features

- Modular design allows scores of fixture component combinations to meet installation and lighting needs. Many most-used combinations are offered prewired and assembled, complete with lamp, packaged in a single carton and ready to install.
- Mogul lamp types and wattages:
 - HPS 50W-150W
 - PSMH 70W-250W
- Choice of heat-resistant prismatic glass refractors (NEMA distributions I, III and V), or heat-resistant prismatic glass globes for hazardous area fixtures. Colored and clear polycarbonate globes and Tuff-skin® ① coated glass globes are available but are NOT approved for use in classified areas. Fixtures with these globes do NOT comply with code requirements, and should be used in non-classified areas only. Globes and refractors thread directly into ballast housing.
- Mounting hoods include cone-shaped pendant hood, standard pendant, flexible pendant, ceiling and wall pendants (tapped for 3/4" or 1" NPT), 25° angle stanchion, and 90° (straight) stanchion (both tapped for 1-1/4" or 1-1/2" NPT).
- Cone hood fixtures for pendant mounting shed dust, dirt and combustible fibers. Cone hood inhibits build-up that "insulates" fixture and slows heat transfer, and provides increased surface area for more effective heat dissipation.



Pendant Mount Fixture
with Prismatic Glass Refractor



Straight Stanchion-Mount Fixture
with Prismatic Glass Refractor and
Guard



Pendant Cone Fixture with
Prismatic Glass Globe and Guard



Ceiling Mount Fixture
with Prismatic Glass Globe, Guard
and Polyester 30° Angle Reflector

- Reflector choice includes standard dome and 30° angle types, both made of Fiberglass reinforced white polyester. Highly resistant to unusually corrosive applications. Reflectors are vented for cooler, dirt-free operation and maintained lumen output. They secure to ballast housing with stainless steel screws threading into stainless steel inserts.
- For high corrosion resistance, fixture housing, mounting hoods and guards are copperfree cast aluminum with baked epoxy finish, electrostatically applied for uniformity. All exposed hardware is stainless steel.
- Hinge has high lip for added safety during installation and servicing. Hinge and bolt construction assures 360° compression at all points on ballast housing gasket for positive sealing. Swing-away design of captive bolt and nut simplifies servicing.
- Body gaskets and globe gaskets are high-temperature silicone rubber.
- Capacitors are non-PCB type, thermally isolated from ballast.

① Tuff-skin is a registered trademark of Thomas Manufacturing Corp., Parkton, Maryland.

Mercmaster™ III HID 50–250 Watt Luminaires

High Pressure Sodium and Pulse Start Metal Halide

Listed for simultaneous exposure to combustible dusts and flammable gases or vapors.

NEC/CEC:

Class I, Division 2, Groups A, B, C, D
Class I, Zone 2, AEx nA nR IIC (Z2)
Class I, Zone 2, AEx nR IIC (ZB)
Class II, Division 1 and 2, Groups E, F, G
Class III

NEC/CEC:

Simultaneous Exposure (Class I, Division 2)
Class II, Division 1
Fixtures Outside Type (Salt Water)
Type 4X
IP66

- Mogul base porcelain socket with nickel-plated contacts has 200 °C (392 °F) welded leads, prewired to the ballast. Assures trouble-free operation in installations where high ambient temperatures are encountered.
- HPS ballasts are High Power Factor (min. P.F. 90%).
- A wide range of voltages available (120 to 600 Volt) and ballast types (Reactor, CWA and Super CWA).
- All Mercmaster III mounting hoods have provision for easy field installation of fuses in fixtures (see fuse kit listings in this catalog section).
- For electrical protection, a ground wire is provided on each Mercmaster to bond hood and ballast housing.
- The AEx nA nR factory sealed Mercmaster III prevents vapors and gases from entering the globe chamber. There are no seals or putty required which will reduce installation time and installation errors.
- The AEx nR Mercmaster III fixture requires all wiring entries to be sealed.

Standard Materials

- Mounting hoods, ballast bodies and guards: copperfree cast aluminum (less than 4/10 of 1%)
- Exposed hardware: stainless steel; latch assemblies have stainless steel bolt and captive nut; reflectors and guards attach with stainless steel screws threading into stainless steel inserts.
- Reflectors: Fiberglass reinforced white polyester
- Globes: heat-resistant prismatic glass
- Refractors: heat-resistant prismatic glass

Standard Finishes

- Mounting hoods, ballast bodies, guards: epoxy powder coat finish, electrostatically applied for complete, uniform surface protection
- Reflectors: white polyester finish

Options

- AEx nA nR fixtures are available with a Class I, Zone 2 rating. Add suffix **-Z2**.
- AEx nR fixtures are available with a Class I, Zone 2 rating. Add suffix **-ZB**.
- Fuses can be field-installed on Mercmaster III fixtures. Kits include fuse block, wire connectors and screws for attaching to mounting hood. Fixtures with fuses do not comply with Marine Type Electric Fixtures Outside Type (Salt Water) requirements for marine listing. For fuse kits, see *Electrical Specifications and Fuse Kits* page.
- Hot Restrike will restrike HPS lamp immediately when power is restored after a momentary power interruption. Add suffix **-R**.
- Smart Starter incorporates a 1-1/2-minute timer and performs as a conventional starter to normally start lamp. Removes itself from circuit if lamp burns out or is removed from socket. Eliminates starter failures caused by prolonged operation with cycling or failing lamps and simplifies finding their location, reducing maintenance and repair costs. Available for all HPS and PSMH fixtures. Add suffix **-S**.
- Optional photocell for all fixtures except cone and ceiling mount provides automatic “on-off” control.
- Quartz Auxiliary comes to full brightness immediately and remains lit until the HID lamp attains 60-70% of full illumination. Quartz Auxiliary supplied with relay switch and socket to accept 120 V quartz double contact bayonet base lamp (not included). Add suffix **-E** to fixture catalog number. ①

NEC/CEC Certifications and Compliances

- cULus Listed: E10444
- UL Standard: ANSI/UL 844, 1598, 60079-0, 60079-15, Marine Type Electric Fixtures Outside Type (Salt Water)
- CSA Certified: 025428
- CSA Standard: CSA C22.2 No. 9, C22.2 No. 137; CAN/CSA E60079-0, E60079-15
- PSMH 250W MT (120/208/240/277, 60 Hz) Fixtures are not UL Listed

Related Products

- Classified area photo controls are also available.

① Fixtures equipped with a quartz auxiliary lamp do not comply with UL requirements and are not suitable for use in classified locations.

Mercmaster™ III HID 50–250 Watt Luminaires

High Pressure Sodium and Pulse Start Metal Halide

Listed for simultaneous exposure to combustible dusts and flammable gases or vapors.

NEC/CEC:

Class I, Division 2, Groups A, B, C, D
Class I, Zone 2, AEx nA nR IIC (Z2)
Class I, Zone 2, AEx nR IIC (ZB)
Class II, Division 1 and 2, Groups E, F, G
Class III

NEC/CEC:

Simultaneous Exposure (Class I, Division 2/
Class II, Division 1)
Fixtures Outside Type (Salt Water)
Type 4X
IP66

Illustrated Features



High Temperature Sockets

Mogul base high-temperature porcelain sockets.

Aluminum Inner Reflector

Solid aluminum inner reflector (for refractor ballast housings only) improves photometric efficiency.

Globe Chamber (Zone 2)

Completely sealed from the ballast housing and outside vapors/air (nA nR).



Vented Reflectors

Reflectors are thick, tough fiberglass-reinforced white polyester, vented for cooler operation. Quickly attach with furnished stainless steel screws.

Terminal Blocks (Zone 2)

A seven-point terminal block is provided to facilitate wiring. Terminal block accommodates wire size ranging from #8 to #24 AWG.

Stainless Steel Inserts

Ballast bodies have stainless steel threaded inserts to receive stainless steel screws for reflectors and guard. Prevents "freezing", allowing guards and reflectors to be easily removed and replaced at any time, without damage to the housing.



Ballast Assembly (Zone 2)

Utilizing non-sparking components avoiding the ignition of gases or vapors that may be present (nA).

Mounting Hood and Globe Gaskets

Silicone rubber gasket seals out moisture, dirt and dust. Stays flexible, withstands high temperatures. Closure design assures uniform gasket compression.

Electrical Protection

Ground wire provided to bond mounting hood to ballast housing.



"Safety" High Hinge

Extra-high hinge provides additional protection against accidental ballast housing disengagement during installation or maintenance.



Stainless Steel Latch Assembly

Captive, stainless steel latch assembly bolt and nut closes securely, resists attack of corrosive atmospheres. Swing-away design simplifies servicing.

Epoxy Finish

Ballast housing, hoods and guards are copperfree aluminum with epoxy powder coat finish.

Photocell

Available for all fixtures except cone and ceiling mount. Installs through knock-out in mounting hood. Provides continuous ON-OFF dusk-to-dawn control.

Heat-Resistant Globes and Refractors

Prismatic glass globes and refractors are heat-resistant. They thread directly into the ballast housing and seal against a high-temperature silicone rubber gasket.



Cooler Operating Cone Hood

Larger sloped surface sheds dusts, dirt and combustible fibers providing better heat dissipation.



Fuses

Two screws secure fuse kit to mounting boss in any Mercmaster mounting hood. Fuse included.

Mercmaster™ III HID 50–250 Watt Luminaires

High Pressure Sodium and Pulse Start Metal Halide

Listed for simultaneous exposure to combustible dusts and flammable gases or vapors.

NEC/CEC:

Class I, Division 2, Groups A, B, C, D
 Class I, Zone 2, AEx nA nR IIC (Z2)
 Class I, Zone 2, AEx nR IIC (ZB)
 Class II, Division 1 and 2, Groups E, F, G
 Class III

NEC/CEC:

Simultaneous Exposure (Class I, Division 2/
 Class II, Division 1)
 Fixtures Outside Type (Salt Water)
 Type 4X
 IP66

Quartz Emergency Light for Pulse Start Metal Halide or High Pressure Sodium Fixtures ①

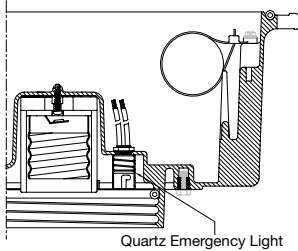

Quartz Emergency Light for PSMH or HPS Fixtures

Mercmaster fixtures for or metal halide and high pressure sodium lamps can be supplied with a socket to accept a 150 W or 250 W, 120 V quartz lamp. This D.C. bayonet base socket is in addition to the standard lamp socket. In the event of a momentary power interruption, the quartz lamp is automatically switched on. The single ended quartz lamp remains energized until the HID restrikes and reaches about 60% output.

The quartz emergency lamp socket is wired to a 120 V tap on the ballast and is therefore independent of the lighting fixture voltage. No special field wiring is necessary.

Description	Catalog Suffix
For fixture volts of 120, 208, 240 or 277	-MTE
For fixture volts of 480	-48E

Accessory Options

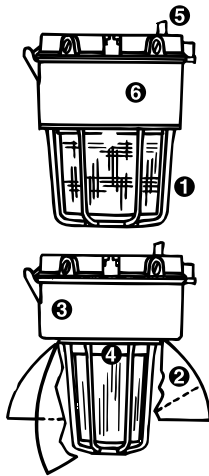

- ① **Guards:** Guards are die-cast copperfree aluminum with baked epoxy finish to match fixtures. Fixture supplied with stainless steel mounting screws which thread into stainless steel inserts on fixture housing to attach guard. To order fixture with guard, add suffix **-G** to catalog number before adding voltage suffix.
- ② **Reflectors:** Standard dome and 30° angle polyester reflectors are shown elsewhere in this catalog section.
- ③ **Hot Restrike:** Instantly restrikes a hot HPS lamp when power is restored after a momentary outage. Available factory-installed only. To order, add suffix **-R** to catalog number.
- ④ **Quartz Emergency Light:** When ordered, HPS fixtures will be supplied with a prewired special DC bayonet base socket to accept a 150W, 120 V quartz lamp (not furnished) that automatically switches on when a power outage occurs. Fixtures ordered with this quartz emergency lamp feature do NOT comply with requirements for classified areas and should be used only in non-classified locations. To order, add suffix **-E** to catalog number and specify if a relay switch is desired.
- ⑤ **Photocell and Fuses:** Photocontrols are available.
- ⑥ **Smart Starter:** Performs as a conventional starter in lamp start-up. Removes itself from circuit at end of lamp life or if lamp is out of socket. Add suffix **-S** to catalog number.

① NOTE: Fixtures equipped with quartz emergency light do not comply with UL requirements and are not suitable for use in classified locations.

Mercmaster™ III HID 50–250 Watt Luminaires

High Pressure Sodium and Pulse Start Metal Halide

Listed for simultaneous exposure to combustible dusts and flammable gases or vapors.

NEC/CEC:

Class I, Division 2, Groups A, B, C, D
 Class I, Zone 2, AEx nA nR IIC (Z2)
 Class I, Zone 2, AEx nR IIC (ZB)
 Class II, Division 1 and 2, Groups E, F, G
 Class III

NEC/CEC:

Simultaneous Exposure (Class I, Division 2)
 Class II, Division 1)
 Fixtures Outside Type (Salt Water)
 Type 4X
 IP66

Mercmaster III 50-250 Family Tree

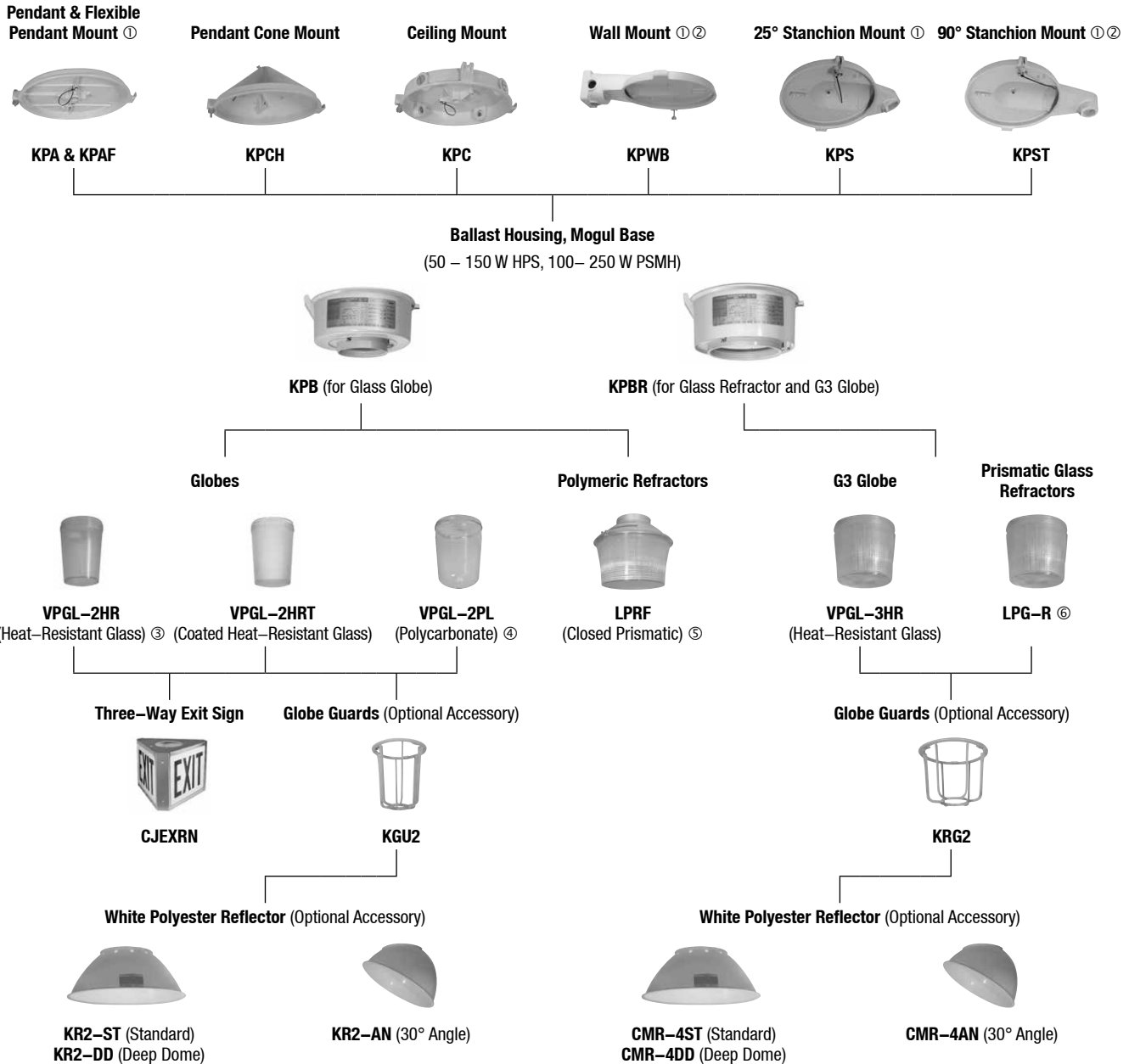

① Mounting hood with a 120 V or 208-277 V factory installed photocell is available.

② Standard and deep dome reflectors may interfere with bottom conduit entry if used with KPST and KPWB mounting hoods..

③ Available in clear, amber, blue, green and red.

④ Available in clear, amber, green and red.

⑤ Available in NEMA Type II, III, IV and V. Polymeric Refractor suitable for Class II, Groups F and G, NEMA 4X and Marine Type Electric Fixtures Outside Type (Salt Water) only (100 W PSMH Max.).

⑥ Available in NEMA Type I, III and V.

Mercmaster™ III HID 50–250 Watt Luminaires

High Pressure Sodium and Pulse Start Metal Halide

Listed for simultaneous exposure to combustible dusts and flammable gases or vapors.

NEC/CEC:

Class I, Division 2, Groups A, B, C, D
 Class I, Zone 2, AEx nA nR IIC (Z2)
 Class I, Zone 2, AEx nR IIC (ZB)
 Class II, Division 1 and 2, Groups E, F, G
 Class III

NEC/CEC:

Simultaneous Exposure (Class I, Division 2/
 Class II, Division 1)
 Fixtures Outside Type (Salt Water)
 Type 4X
 IP66

Order using catalog numbering guide below or select catalog number from tables on following pages.

Catalog Numbering Guide

<p>KP</p> <p>Series: KP - Mercmaster III 250</p>	<p>A</p> <p>Mounting: A - Pendant (rigid mounting) C - Ceiling CH - Pendant Cone Hood F - Pendant (flexible mounting) ST - 90° Stanchion S - 25° Stanchion WB - Wall</p>	<p>L</p> <p>Lamp Type: L - High Pressure Sodium H or P - Pulse Start Metal Halide ①</p>	<p>70</p> <p>Wattage: 10 - 100 W HPS, PSMH 15 - 150 W HPS, PSMH 17 - 175 W PSMH 20 - 200 W PSMH 25 - 250 W PSMH ④ 50 - 50 W HPS (MT - Voltage Only) 70 - 70 W HPS, PSMH</p>	<p>10</p> <p>Hub Size: 75 - 3/4" NPT 10 - 1" NPT 125 - 1-1/4" NPT stanchion 150 - 1-1/2" NPT stanchion</p>	<p>J5</p> <p>Optical Assembly: Blank - Glass Globe J1 - NEMA I Glass Refractor J3 - NEMA III Glass Refractor J5 - NEMA V Glass Refractor G3 - Large Glass Globe</p>	<p>G</p> <p>Guard Options: G - Guard Blank - No Guard</p>	<p>MT</p> <p>Voltage: ② MT - 120/208/240/277, 60 Hz 5MT - 120/208/240/ 277/480, 60 Hz 48 - 480, 60 Hz 125 - 120, 50 Hz 225 - 220, 50 Hz 226 - 220, 60 Hz 235 - 230, 50 Hz 245 - 240, 50 Hz</p>	<p>R</p> <p>Options: E - Emergency Quartz F - Fuse Kit (Specify Voltage) R - Hot Restrike (50-150 W HPS only) S - Smart Starter K - Kynar Coating H1 - Photocontrol 120 V H2 - Photocontrol 208 V H3 - Photocontrol 240 V H4 - Photocontrol 277 V C - Safety Cable Adapted E40 - Export Socket T - Terminal Blocks</p> <p>Optional Fusing ③ FN - 120 V FP - 208 V FS - 240 V FT - 277 V FF - 480 V</p>	<p>Z2</p> <p>Suffix: Z2 - Zone 2 suffix (required for AEx nA nR rating) ZB - Zone 2 suffix (required for AEx nR rating)</p>
--	--	--	--	---	--	--	---	--	---

Reflectors are ordered separately – see Accessories page.

① H - Lamp type is for 70W and 100W fixtures only.

P - Lamp type is for 175W, 200W and 250W fixtures only.

② Voltages shown are limited to specific combinations.

③ Optional fusing is available for use with MT, 5MT and 48 voltage suffixes ONLY.

④ PSMH 250 W, MT fixtures are not UL Listed.



HID/AREA: NEC/CEC ENCLOSED AND GASKETED

Mercmaster™ III HID 50–250 Watt Luminaires

Class I, Division 2; Class II, Division 1; Simultaneous Exposure to Hazardous Conditions of Both Classifications

Temperature Identification Numbers of Mercmaster III fixtures.

NEC/CEC:
 Class I, Division 2, Groups A, B, C, D
 Class I, Zone 2, AEx nA nR IIC (Z2)
 Class I, Zone 2, AEx nR IIC (ZB)
 Class II, Division 1 and 2, Groups E, F, G
 Class III

NEC/CEC:
 Simultaneous Exposure (Class I, Division 2)
 Class II, Division 1)
 Fixtures Outside Type (Salt Water)
 Type 4X
 IP66

Mercmaster III fixtures are listed for “Simultaneous Exposure” to combinations of Class I, Division 2 and Class II, Division 1 hazardous conditions.

“T” Numbers for Mercmaster III Fixtures

Watts	Lamp Type	Supply Wire Temp. °C (°F)	Ambient Temp. °C (°F)	Class I, Division 2				Class II, Division 1 Groups E, F and G ①				Simultaneous Exposure Class I, Division 2 / Class II, Division 1			
				Globe	Reflector	G3	8”	Globe	Reflector	G3	8”	Globe	Reflector	G3	8”
50	HPS	90 °C (194 °F)	40 °C (104 °F)	T3C	T3B	—	T3C	T4A	T4	—	T6	T3A	T3	—	T3C
		90 °C (194 °F)	55 °C (131 °F)	T3A	T3A	—	T3A	T4	T3B	—	T5	T3	T3	—	T3A
		90 °C (194 °F)	65 °C (149 °F)	T3A	T3	—	T3A	T3C	T3C	—	T4A	T2D	T2D	—	T3
70	HPS	90 °C (194 °F)	40 °C (104 °F)	T3B	T3A	—	T3C	T4	T3C	—	T6	T3	T3	—	T3A
		90 °C (194 °F)	55 °C (131 °F)	T3A	T3A	—	T3B	T3C	T3C	—	T5	T2D	T2D	—	T3
		90 °C (194 °F)	65 °C (149 °F)	T3	T3A	—	T3A	T3C	T3B	—	T4A	T2C	T2C	—	T3
100	HPS	90 °C (194 °F)	40 °C (104 °F)	T2D	T2D	T3	T3	—	T3A (EF) T3 (EF)		—	—	—	—	—
		90 °C (194 °F)	40 °C (104 °F)	—	—	—	—	T3B	—	T4A	T4A	T2B	T2B	T2C	T2C
		90 °C (194 °F)	55 °C (131 °F)	T2D	T2D	T3	T3	—	—	T4	T4	—	—	T2B	T2B
		90 °C (194 °F)	65 °C (149 °F)	T2D	T2D	T2D	T2D	—	—	—	—	—	—	—	—
150	HPS	90 °C (194 °F)	40 °C (104 °F)	T2B	T2B	—	T2C	—	—	—	T3C	T2	—	—	T2B
		90 °C (194 °F)	40 °C (104 °F)	—	—	—	—	T3 (EF)	—	—	—	—	—	—	—
		90 °C (194 °F)	55 °C (131 °F)	T2B	T2A	—	T2B	—	—	—	—	—	—	—	—
70	PSMH	90 °C (194 °F)	40 °C (104 °F)	T3A	T3A	—	T3A	—	—	—	T3C	—	—	—	—
		90 °C (194 °F)	55 °C (131 °F)	T3A	T3A	—	T3A	—	—	—	T3C	—	—	—	—
		90 °C (194 °F)	65 °C (149 °F)	T3	T2	—	T3	—	—	—	T3C	—	—	—	—
100	PSMH	90 °C (194 °F)	40 °C (104 °F)	T3	T3	—	T3	—	—	—	T3C	—	—	—	T2B
		90 °C (194 °F)	55 °C (131 °F)	T3	T3	—	T3	—	—	—	T3C	—	—	—	T2A
		90 °C (194 °F)	65 °C (149 °F)	T2D	T2D	—	T2D	—	—	—	T3C	—	—	—	—
150	PSMH	90 °C (194 °F)	40 °C (104 °F)	T2B	T2B	—	T2B	—	—	—	T3C	—	—	—	T2B
		90 °C (194 °F)	55 °C (131 °F)	T2A	T2A	—	T2B	—	—	—	T3C	—	—	—	T2A
		125 °C (257 °F)	65 °C (149 °F)	T2A	T2	—	T2B	—	—	—	T3C	—	—	—	—
175	PSMH	90 °C (194 °F)	40 °C (104 °F)	T2B	T2B	—	T2B	—	—	—	T3C	—	—	—	T2B
		90 °C (194 °F)	55 °C (131 °F)	T2A	T2A	—	T2B	—	—	—	T3C	—	—	—	T2A
		125 °C (257 °F)	65 °C (149 °F)	T2A	T2	—	T2B	—	—	—	—	—	—	—	—
200	PSMH	90 °C (194 °F)	40 °C (104 °F)	T2B	T2B	—	T2B	—	—	—	T3B	—	—	—	—
		90 °C (194 °F)	55 °C (131 °F)	T2B	T2B	—	T2B	—	—	—	—	—	—	—	—
250	PSMH	90 °C (194 °F)	40 °C (104 °F)	T2	T2	—	T2	—	—	—	—	—	—	—	—
		90 °C (194 °F)	55 °C (131 °F)	T2	T2	—	T2	—	—	—	—	—	—	—	—

“T” Numbers Represent the Maximum Lamp Temperature for Class I, Division 2 Locations and Maximum Surface Temperature Under Dust Blanket for Class II, Division 1 Locations.

“T” Number	T1	350	325	T2	T2A	T2B	T2C	T2D	T3	T3A	T3B	T3C	T4	T4A	T5	T6
Temp. Range (°C)	351-450	326-350	301-325	281-300	261-280	231-260	216-230	201-215	181-200	166-180	161-165	136-160	121-135	101-120	86-100	85
Temp. Range (°F)	664-842	619-662	574-617	538-572	502-536	448-500	421-446	394-419	358-392	331-356	322-329	277-320	250-275	214-248	187-212	185

① All Class II T Numbers are E, F, G unless otherwise indicated.

Mercmaster™ III HID 50–250 Watt Luminaires

Class I, Zone 2, AEx nA nR IIC; Class 1 Zone 2, AEx nR IIC; IP66; and NEMA 4X

Temperature Identification Numbers of Mercmaster III Fixtures.

NEC/CEC:

Class I, Division 2, Groups A, B, C, D
 Class I, Zone 2, AEx nA nR IIC (Z2)
 Class I, Zone 2, AEx nR IIC (ZB)
 Class II, Division 1 and 2, Groups E, F, G
 Class III

NEC/CEC:

Simultaneous Exposure (Class I, Division 2)
 Class II, Division 1)
 Fixtures Outside Type (Salt Water)
 Type 4X
 IP66

Operating Temperatures: “T” Numbers for Zone 2 Mercmaster III Fixtures

The “T” number is established by separately determining the maximum temperature of the globe surface and ballast compartment. The hotter of the two is taken to determine the “T” number for the overall fixture.

Lamp Watts	Type	Supply Wire Temp. °C (°F)	Ambient Temp. °C (°F)	Class I, Zone 2 AEx nA nR IIC				Class I, Zone 2 AEx nR IIC			
				Globe	Globe & Reflector	Reflector Only	G3/Reflector & Reflector	Globe	Globe & Reflector	Reflector Only	G3/Reflector & Reflector
50	HPS	90 °C (194 °F)	40 °C (104 °F)	T4	T4	T6	T4	T4	T4	T6	T4
		90 °C (194 °F)	55 °C (131 °F)	T4	T3	T5	T3	T4	T3	T5	T3
		90 °C (194 °F)	65 °C (149 °F)	T3	T3	T4	T3	T3	T3	T4	T3
70	HPS	90 °C (194 °F)	40 °C (104 °F)	T4	T4	T4	T4	T6	T5	T6	T4
		90 °C (194 °F)	55 °C (131 °F)	T4	T4	T4	T3	T5	T4	T5	T3
		90 °C (194 °F)	65 °C (149 °F)	T4	T4	T3	T3	T4	T4	T5	T3
100	HPS	90 °C (194 °F)	40 °C (104 °F)	T4	T4	T4	T4	T5	T4	T6	T4
		90 °C (194 °F)	55 °C (131 °F)	T4	T4	T3	T3	T4	T4	T5	T3
		90 °C (194 °F)	65 °C (149 °F)	T4	T4	T3	T3	T4	T4	T4	T3
150	HPS	90 °C (194 °F)	40 °C (104 °F)	T4	T3	T3	T3	T4	T4	T5	T4
		90 °C (194 °F)	55 °C (131 °F)	T3	T3	T3	T3	T4	T4	T4	T3
		105 °C (221 °F)	65 °C (149 °F)	T3	T3	T3	T3	T4	T3	T4	T3
70	PSMH	90 °C (194 °F)	40 °C (104 °F)	T4	T4	T4	—	T5	T4	T6	—
		90 °C (194 °F)	55 °C (131 °F)	T3	T3	T3	—	T4	T4	T5	—
		90 °C (194 °F)	65 °C (149 °F)	T3	T3	T3	—	T4	T3	T4	—
100	PSMH	90 °C (194 °F)	40 °C (104 °F)	T3	T3	T3	—	T5	T4	T6	—
		90 °C (194 °F)	55 °C (131 °F)	T3	T3	T3	—	T4	T4	T5	—
		90 °C (194 °F)	65 °C (149 °F)	T3	T3	T3	—	T4	T3	T4	—
150	PSMH	90 °C (194 °F)	40 °C (104 °F)	T4	T4	T4	—	T4	T4	T5	—
		90 °C (194 °F)	55 °C (131 °F)	T3	T3	T3	—	T4	T3	T4	—
		105 °C (221 °F)	65 °C (149 °F)	T3	T3	T3	—	T4	T3	T4	—
175	PSMH	90 °C (194 °F)	40 °C (104 °F)	T3	T3	T4	—	T3	T3	T4	—
		90 °C (194 °F)	55 °C (131 °F)	T3	T3	T3	—	T3	T3	T4	—
		105 °C (221 °F)	65 °C (149 °F)	T3	T3	T3	—	T3	T3	T4	—
200	PSMH	90 °C (194 °F)	40 °C (104 °F)	T3	T3	T4	—	T3	T3	T4	—
		105 °C (221 °F)	55 °C (131 °F)	T3	T3	T3	—	T3	T3	T4	—
		105 °C (221 °F)	65 °C (149 °F)	T3	T3	T3	—	T3	T3	T4	—
250	PSMH	90 °C (194 °F)	40 °C (104 °F)	T3	T3	T3	—	T3	T3	T3	—
		90 °C (194 °F)	55 °C (131 °F)	T3	T3	T3	—	T3	T3	T3	—

“T” Numbers Represent the Maximum Surface Temperature for Luminaires with AEx nA nR or AEx nR rating

“T” Number	T1	T2	T3	T4	T5	T6
Temp. Range (°C)	301-450	201-300	136-200	101-135	86-100	85
Temp. Range (°F)	547-842	394-572	277-392	214-275	187-212	185

Mercmaster™ III HID 50–250 Watt Luminaires

Class I, Division 2; Class II, Division 1; Simultaneous Exposure to Hazardous Conditions of Both Classifications

Maximum Temperatures in °C (°F) Obtained from Tests in a 40 °C (104 °F) Ambient, Vertical Position, Lamp Base Up, as per NEC.

NEC/CEC:
 Class I, Division 2, Groups A, B, C, D
 Class I, Zone 2, AEx nA nR IIC (Z2)
 Class I, Zone 2, AEx nR IIC (ZB)
 Class II, Division 1 and 2, Groups E, F, G
 Class III

NEC/CEC:
 Simultaneous Exposure (Class I, Division 2)
 Class II, Division 1)
 Fixtures Outside Type (Salt Water)
 Type 4X
 IP66

Fixture Selection Guide Indicates atmosphere for which fixture is suitable.

① Denotes fixture with Globe Only. ② Denotes fixture with Globe and Reflector. ③ Denotes fixture with 8" Refractor / G3 Globe

Class I, Division 2 Chemical	Ignition °C (°F) ④	Minimum Fixture "T" Number for Chemical	HPS (Watts)				PSMH (Watts)					
			50	70	100	150	70	100	175	200	250	
Group A Atmospheres												
acetylene	305 °C (581 °F)	T2	①②③	①②③	①②③	①②③	①②	①②③	①②③	①	③	①②
Group B Atmospheres												
acrolein (inhibited)	220 °C (428 °F)	T2D	①②③	①②③	①②③		①②	①②③				①②
arsine	NA ⑤											
butadiene	420 °C (788 °F)	350	①②③	①②③	①②③	①②③	①②	①②③	①②③	①②③	①②③	①②
ethylene oxide	429 °C (804 °F)	350	①②③	①②③	①②③	①②③	①②	①②③	①②③	①②③	①②③	①②
hydrogen	500 °C (932 °F)	T1	①②③	①②③	①②③	①②③	①②	①②③	①②③	①②③	①②③	①②
propylene oxide	449 °C (840 °F)	350	①②③	①②③	①②③	①②③	①②	①②③	①②③	①②③	①②③	①②
propyl nitrate	175 °C (347 °F)	T3B	①②③	①②③			①②					
Group C Atmospheres												
acetaldehyde	175 °C (347 °F)	T3B	①②③	①	③		①②					
allyl alcohol	378 °C (712 °F)	350	①②③	①②③	①②③	①②③	①②	①②③	①②③	①②③	①②③	①②
n-butylaldehyde	218 °C (424 °F)	T2D	①②③	①②③	①②③		①②	①②③				①②
carbon monoxide	609 °C (1128 °F)	T1	①②③	①②③	①②③	①②③	①②	①②③	①②③	①②③	①②③	①②
crotonaldehyde	232 °C (450 °F)	T2C	①②③	①②③	①②③	③	①②	①②③				①②
cyclopropane	498 °C (928 °F)	T1	①②③	①②③	①②③	①②③	①②	①②③	①②③	①②③	①②③	①②
diethyl ether (ethyl ether)	160 °C (320 °F)	T3C	①	③	③		①②					
diethylamine	312 °C (594 °F)	T2	①②③	①②③	①②③	①②③	①②	①②③	①②③	①	③	①②
ethylene	450 °C (842 °F)	T1	①②③	①②③	①②③	①②③	①②	①②③	①②③	①②③	①②③	①②
ethylenimine	320 °C (608 °F)	T2	①②③	①②③	①②③	①②③	①②	①②③	①②③	①	③	①②
ethyl mercaptan	300 °C (572 °F)	T2	①②③	①②③	①②③	①②③	①②	①②③	①②③	①	③	①②
ethyl sulfide	NA ⑤											
hydrogen cyanide	538 °C (1000 °F)	T1	①②③	①②③	①②③	①②③	①②	①②③	①②③	①②③	①②③	①②
hydrogen sulfide	260 °C (500 °F)	T2B	①②③	①②③	①②③	①②③	①②	①②③	①②③	①		①②
morpholine	310 °C (590 °F)	T2	①②③	①②③	①②③	①②③	①②	①②③	①②③	①	③	①②
2-nitropropane	428 °C (802 °F)	350	①②③	①②③	①②③	①②③	①②	①②③	①②③	①②③	①②③	①②
tetrahydrofuran	321 °C (610 °F)	T2	①②③	①②③	①②③	①②③	①②	①②③	①②③	①	③	①②
unsymmetrical dimethyl hydrazine	249 °C (480 °F)	T2C	①②③	①②③	①②③	③	①②	①②③				①②
Group D Atmospheres												
acetic acid (glacial)	464 °C (867 °F)	T1	①②③	①②③	①②③	①②③	①②	①②③	①②③	①②③	①②③	①②
acetone	465 °C (869 °F)	T1	①②③	①②③	①②③	①②③	①②	①②③	①②③	①②③	①②③	①②
acrylonitrile	481 °C (898 °F)	T1	①②③	①②③	①②③	①②③	①②	①②③	①②③	①②③	①②③	①②
ammonia	651 °C (1204 °F)	T1	①②③	①②③	①②③	①②③	①②	①②③	①②③	①②③	①②③	①②
benzene	498 °C (928 °F)	T1	①②③	①②③	①②③	①②③	①②	①②③	①②③	①②③	①②③	①②
butane	287 °C (549 °F)	T2A	①②③	①②③	①②③	①②③	①②	①②③	①②③	①		①②
1-butanol (butyl alcohol)	343 °C (649 °F)	325	①②③	①②③	①②③	①②③	①②	①②③	①②③	①②③	①②③	①②

This classified area suitability chart is based on NEC requirements and Appleton and UL testing. However, the ultimate decision on suitability of these fixtures for classified areas depends solely on the judgement of the owner, insurance company, inspector and/or authority having jurisdiction.

④ Ignition temperatures shown should be regarded as approximations only. Per NFPA Bulletin 325M, ignition temperatures may vary according to such factors as vapor/air mixture, size and space where ignition may occur, rate and duration of heating, oxygen concentration and other materials present.

⑤ Not Available.

Mercmaster™ III HID 50–250 Watt Luminaires

Class I, Division 2; Class II, Division 1; Simultaneous Exposure to Hazardous Conditions of Both Classifications

Maximum Temperatures in °C (°F) Obtained from Tests in a 40 °C (104 °F) Ambient, Vertical Position, Lamp Base Up, as per NEC.

NEC/CEC:

Class I, Division 2, Groups A, B, C, D
 Class I, Zone 2, AEx nA nR IIC (Z2)
 Class I, Zone 2, AEx nR IIC (ZB)
 Class II, Division 1 and 2, Groups E, F, G
 Class III

NEC/CEC:

Simultaneous Exposure (Class I, Division 2/
 Class II, Division 1)
 Fixtures Outside Type (Salt Water)
 Type 4X
 IP66

Fixture Selection Guide Indicates atmosphere for which fixture is suitable.

① Denotes fixture with Globe Only. ② Denotes fixture with Globe and Reflector. ③ Denotes fixture with 8" Refractor / G3 Globe

Class I, Division 2 Chemical	Ignition °C (°F) ④	Minimum Fixture "T" Number for Chemical	HPS (Watts)				PSMH (Watts)				
			50	70	100	150	70	100	175	200	250
Group D Atmospheres											
2-butanol (secondary butyl alcohol)	405 °C (761 °F)	350	①②③	①②③	①②③	①②③	①②	①②③	①②③	①②③	①②
n-butyl acetate	425 °C (797 °F)	350	①②③	①②③	①②③	①②③	①②	①②③	①②③	①②③	①②
isobutyl acetate	421 °C (790 °F)	350	①②③	①②③	①②③	①②③	①②	①②③	①②③	①②③	①②
sec-butyl alcohol	343 °C (649 °F)	325	①②③	①②③	①②③	①②③	①②	①②③	①②③	①②③	①②
di-isobutylene	391 °C (736 °F)	350	①②③	①②③	①②③	①②③	①②	①②③	①②③	①②③	①②
ethane	472 °C (882 °F)	T1	①②③	①②③	①②③	①②③	①②	①②③	①②③	①②③	①②
ethanol (ethyl alcohol)	363 °C (685 °F)	350	①②③	①②③	①②③	①②③	①②	①②③	①②③	①②③	①②
ethyl acetate	426 °C (799 °F)	350	①②③	①②③	①②③	①②③	①②	①②③	①②③	①②③	①②
ethylene diamine (anhydrous)	385 °C (725 °F)	350	①②③	①②③	①②③	①②③	①②	①②③	①②③	①②③	①②
ethylene dichloride	413 °C (775 °F)	350	①②③	①②③	①②③	①②③	①②	①②③	①②③	①②③	①②
gasoline (56-60 octane)	280 °C (536 °F)	T2A	①②③	①②③	①②③	①②③	①②	①②③	①②③	①	①②
heptanes	204 °C (399 °F)	T3	①②③	①②③	①②③		①②	①②③			
hexanes	223 °C (433 °F)	T2D	①②③	①②③	①②③		①②	①②③			
isoprene	395 °C (743 °F)	350	①②③	①②③	①②③	①②③	①②	①②③	①②③	①②③	①②
isopropyl ether	443 °C (829 °F)	350	①②③	①②③	①②③	①②③	①②	①②③	①②③	①②③	①②
mesityl oxide	344 °C (651 °F)	325	①②③	①②③	①②③	①②③	①②	①②③	①②③	①②③	①②
methane (natural gas)	537 °C (999 °F)	T1	①②③	①②③	①②③	①②③	①②	①②③	①②③	①②③	①②
methanol (methyl alcohol)	385 °C (725 °F)	350	①②③	①②③	①②③	①②③	①②	①②③	①②③	①②③	①②
3-methyl-1-butanol (isoamyl alcohol)	350 °C (662 °F)	350	①②③	①②③	①②③	①②③	①②	①②③	①②③	①②③	①②
methyl ethyl ketone	404 °C (759 °F)	350	①②③	①②③	①②③	①②③	①②	①②③	①②③	①②③	①②
methyl isobutyl ketone	448 °C (838 °F)	350	①②③	①②③	①②③	①②③	①②	①②③	①②③	①②③	①②
2-methyl-1-propanol (isobutyl alcohol)	415 °C (779 °F)	350	①②③	①②③	①②③	①②③	①②	①②③	①②③	①②③	①②
2-methyl-1-propanol (tertiary butyl alcohol)	478 °C (892 °F)	T1	①②③	①②③	①②③	①②③	①②	①②③	①②③	①②③	①②
petroleum naphtha ⑥	288 °C (550 °F)	T2A	①②③	①②③	①②③	①②③	①②	①②③	①②③	①	①②
pyridine	482 °C (900 °F)	T1	①②③	①②③	①②③	①②③	①②	①②③	①②③	①②③	①②
octanes	206 °C (403 °F)	T3	①②③	①②③	①②③		①②	①②③			
pentanes	260 °C (500 °F)	T2B	①②③	①②③	①②③	①②③	①②	①②③	①②③	①	①②
1-pentanol (amyl alcohol)	300 °C (572 °F)	T2	①②③	①②③	①②③	①②③	①②	①②③	①②③	①	①②
propane	432 °C (810 °F)	350	①②③	①②③	①②③	①②③	①②	①②③	①②③	①②③	①②
1-propanol (propyl alcohol)	412 °C (774 °F)	350	①②③	①②③	①②③	①②③	①②	①②③	①②③	①②③	①②
2-propanol (isopropyl alcohol)	399 °C (750 °F)	350	①②③	①②③	①②③	①②③	①②	①②③	①②③	①②③	①②
propylene	455 °C (851 °F)	T1	①②③	①②③	①②③	①②③	①②	①②③	①②③	①②③	①②
styrene	490 °C (914 °F)	T1	①②③	①②③	①②③	①②③	①②	①②③	①②③	①②③	①②
toluene	480 °C (896 °F)	T1	①②③	①②③	①②③	①②③	①②	①②③	①②③	①②③	①②
vinyl acetate	402 °C (756 °F)	350	①②③	①②③	①②③	①②③	①②	①②③	①②③	①②③	①②
vinyl chloride	472 °C (882 °F)	T1	①②③	①②③	①②③	①②③	①②	①②③	①②③	①②③	①②
xylenes (o-xylene)	463 °C (865 °F)	T1	①②③	①②③	①②③	①②③	①②	①②③	①②③	①②③	①②

This classified area suitability chart is based on NEC requirements and Appleton and UL testing. However, the ultimate decision on suitability of these fixtures for classified areas depends solely on the judgement of the owner, insurance company, inspector and/or authority having jurisdiction.

④ Ignition temperatures shown should be regarded as approximations only. Per NFPA Bulletin 325M, ignition temperatures may vary according to such factors as vapor/air mixture, size and space where ignition may occur, rate and duration of heating, oxygen concentration and other materials present.

⑥ A saturated hydrocarbon mixture. Also known by synonyms benzine, ligroin, petroleum, ether and naphtha.

Mercmaster™ III HID 50–250 Watt Luminaires

Class I, Zone 2, AEx nA nR IIC; Class 1 Zone 2, AEx nR IIC; IP66; and NEMA 4X

Maximum Temperatures in °C (°F) Obtained from Tests in a 40 °C (104 °F) Ambient, Vertical Position, Lamp Base Up.

NEC/CEC:
 Class I, Division 2, Groups A, B, C, D
 Class I, Zone 2, AEx nA nR IIC (Z2)
 Class I, Zone 2, AEx nR IIC (ZB)
 Class II, Division 1 and 2, Groups E, F, G
 Class III

NEC/CEC:
 Simultaneous Exposure (Class I, Division 2/
 Class II, Division 1)
 Fixtures Outside Type (Salt Water)
 Type 4X
 IP66

Fixture Selection Guide Indicates atmosphere for which fixture is suitable.

② Denotes fixture with Globe and Reflector. ③ Denotes fixture with 8" Refractor.

Class I, Division 2 Chemical	Ignition °C (°F) ④	Minimum Fixture "T" Number for Chemical	HPS (Watts)				PSMH (Watts)				
			50	70	100	150	70	100	175	200	250
Group IIC											
acetylene	305 °C (581 °F)	T2	②③	②③	②③	②③	②③	②③	②③	②③	②③
acetylene	300 °C (572 °F)	T2	②③	②③	②③	②③	②③	②③	②③	②③	②③
hydrogen	500 °C (932 °F)	T1	②③	②③	②③	②③	②③	②③	②③	②③	②③
Group IIB											
ethylene	490 °C (914 °F)	T1	②③	②③	②③	②③	②③	②③	②③	②③	②③
butadiene 1.3	425 °C (797 °F)	T2	②③	②③	②③	②③	②③	②③	②③	②③	②③
carbon monoxide coke oven gas	560 °C (1040 °F)	T1	②③	②③	②③	②③	②③	②③	②③	②③	②③
diethyl ether (ethyl ether)	160 °C (320 °F)	T4	②③	②③	②③	②③	②③				
ethylene	450 °C (842 °F)	T1	②③	②③	②③	②③	②③	②③	②③	②③	②③
ethylenimine ethylene oxide	425 °C (797 °F)	T2	②③	②③	②③	②③	②③	②③	②③	②③	②③
Group IIA											
acetone	465 °C (869 °F)	T1	②③	②③	②③	②③	②③	②③	②③	②③	②③
amyl acetate	375 °C (707 °F)	T2	②③	②③	②③	②③	②③	②③	②③	②③	②③
ammonia	651 °C (1204 °F)	T1	②③	②③	②③	②③	②③	②③	②③	②③	②③
benzene	498 °C (928 °F)	T1	②③	②③	②③	②③	②③	②③	②③	②③	②③
butane	287 °C (549 °F)	T3	②③	②③	②③	②③	②③	②③	②③	②③	
1-butanol (butyl alcohol)	343 °C (649 °F)	T2	②③	②③	②③	②③	②③	②③	②③	②③	②③
n-butyl acetate cyclohexane	260 °C (500 °F)	T3	②③	②③	②③	②③	②③	②③	②③	②③	
ethyl methyl ketone	515 °C (959 °F)	T1	②③	②③	②③	②③	②③	②③	②③	②③	②③
ethanol (ethyl alcohol)	363 °C (685 °F)	T2	②③	②③	②③	②③	②③	②③	②③	②③	②③
ethyl acetate	426 °C (799 °F)	T1	②③	②③	②③	②③	②③	②③	②③	②③	②③
heptanes	204 °C (399 °F)	T3	②③	②③	②③	②③	②③	②③	②③	②③	
hexanes	223 °C (433 °F)	T3	②③	②③	②③	②③	②③	②③	②③	②③	
isoprene isobutanol	430 °C (806 °F)	T2	②③	②③	②③	②③	②③	②③	②③	②③	②③
mesityl oxide methyl acetate	500 °C (932 °F)	T1	②③	②③	②③	②③	②③	②③	②③	②③	②③
methanol (methyl alcohol)	385 °C (725 °F)	T2	②③	②③	②③	②③	②③	②③	②③	②③	②③
n-propyl acetate	500 °C (932 °F)	T1	②③	②③	②③	②③	②③	②③	②③	②③	②③
n-butyl acetate	420 °C (788 °F)	T2	②③	②③	②③	②③	②③	②③	②③	②③	②③
pentanes	260 °C (500 °F)	T3	②③	②③	②③	②③	②③	②③	②③	②③	
propane	432 °C (810 °F)	T2	②③	②③	②③	②③	②③	②③	②③	②③	②③
xylenes (o-xylene)	463 °C (865 °F)	T1	②③	②③	②③	②③	②③	②③	②③	②③	②③

This classified area suitability chart is based on NEC requirements and Appleton and UL testing. However, the ultimate decision on suitability of these fixtures for classified areas depends solely on the judgement of the owner, insurance company, inspector and/or authority having jurisdiction.

④ Ignition temperatures shown should be regarded as approximations only. Per NFPA Bulletin 325M, ignition temperatures may vary according to such factors as vapor/air mixture, size and space where ignition may occur, rate and duration of heating, oxygen concentration and other materials present.

Mercmaster™ III HID 50–250 Watt Luminaires

50 W, 70 W, 100 W, 150 W HPS



High Reactance, High Power Factor (min. P.F. 90%). Heat-Resistant Prismatic Glass Globe or Closed Prismatic Glass Refractor. Mogul Base Lamps.

NEC/CEC:

Class I, Division 2, Groups A, B, C, D
 Class I, Zone 2, AEx nA nR IIC (Z2)
 Class I, Zone 2, AEx nR IIC (ZB)
 Class II, Division 1 and 2, Groups E, F, G
 Class III

NEC/CEC:

Simultaneous Exposure (Class I, Division 2/
 Class II, Division 1)
 Fixtures Outside Type (Salt Water)
 Type 4X
 IP66

	Lamp Type	Lamp Watts	Hub Size (Inches)	Catalog Numbers ③④⑤ with Type V 8" Refractor or G3 Globe ②	
				with Globe	
Pendant — One Hub, Rigid Mounting ①					
	HPS	50	3/4 1	KPAL5075 KPAL5010	KPAL5075J5 KPAL5010J5
	HPS	70	3/4 1	KPAL7075 KPAL7010	KPAL7075J5 KPAL7010J5
	HPS	100	3/4 1	KPAL1075 KPAL1010	KPAL1075J5 KPAL1010J5
	HPS	150	3/4 1	KPAL1575 KPAL1510	KPAL1575J5 KPAL1510J5
Pendant Cone — One Hub, Rigid Mounting					
	HPS	50	3/4 1	KPCHL5075 KPCHL5010	KPCHL5075J5 KPCHL5010J5
	HPS	70	3/4 1	KPCHL7075 KPCHL7010	KPCHL7075J5 KPCHL7010J5
	HPS	100	3/4 1	KPCHL1075 KPCHL1010	KPCHL1075J5 KPCHL1010J5
	HPS	150	3/4 1	KPCHL1575 KPCHL1510	KPCHL1575J5 KPCHL1510J5
Ceiling — Five Hubs, Four Close-Up Plugs					
	HPS	50	3/4 1	KPCL5075 KPCL5010	KPCL5075J5 KPCL5010J5
	HPS	70	3/4 1	KPCL7075 KPCL7010	KPCL7075J5 KPCL7010J5
	HPS	100	3/4 1	KPCL1075 KPCL1010	KPCL1075J5 KPCL1010J5
	HPS	150	3/4 1	KPCL1575 KPCL1510	KPCL1575J5 KPCL1510J5

① For Flexible Pendant Mount, change **A** to **F** in catalog number (except 50 W HPS).

② To order fixtures with large globe change **J5** to **G3**; for fixture with NEMA Type I or NEMA Type III refractor, change final digit **5** in catalog number to **1** or **3**.

③ Add the following voltage and frequency designation before **Z2** suffix:

Lamp Type	Lamp Watts	MT	5MT	48	125	Voltage Suffixes					
						225	226	235	236	245	246
HPS	50	X	—	—	—	X	X	—	X	X	X
HPS	70	X	—	X	X	X	X	—	X	X	X
HPS	100	X	—	X	X	X	X	—	X	X	X
HPS	150	X	—	X	X	X	X	—	—	X	—
PSMH	70	X	—	X	X	X	—	—	—	X	—
PSMH	100	X	—	X	X	X	—	—	—	X	—
PSMH	150	X	—	X	X	X	—	—	—	X	—
PSMH	175	X	X	X	—	—	—	—	—	—	—
PSMH	200	X	—	X	—	—	—	—	—	—	X
PSMH	250	X	—	—	—	—	—	—	X	—	—

Voltages:

MT - 120/208/240/277 V 60 Hz

5MT - 120/208/240/277/480 V 60 Hz

48 - 480 V 60 Hz

125 - 120 V 50 Hz

225 - 225 V 50 Hz

226 - 220 V 60 Hz

235 - 230 V 50 Hz

236 - 230 V 60 Hz

245 - 240 V 50 Hz

246 - 240 V 60 Hz

④ Add **-Z2** suffix for factory sealed non-sparking/restricted breathing protection (AEx nA nR). Add **-ZB** suffix for restricted breathing protection (AEx nR).

⑤ For fixtures with guards, add letter **G** before adding voltage designation.



Mercmaster™ III HID 50–250 Watt Luminaires

50 W, 70 W, 100 W, 150 W HPS

High Reactance, High Power Factor (min. P.F. 90%). Heat-Resistant Prismatic Glass Globe or Closed Prismatic Glass Refractor. Mogul Base Lamps.

NEC/CEC:
Class I, Division 2, Groups A, B, C, D
Class I, Zone 2, AEx nA nR IIC (Z2)
Class I, Zone 2, AEx nR IIC (ZB)
Class II, Division 1 and 2, Groups E, F, G
Class III

NEC/CEC:
Simultaneous Exposure (Class I, Division 2)
Class II, Division 1
Fixtures Outside Type (Salt Water)
Type 4X
IP66

Lamp Type	Lamp Watts	Hub Size (Inches)	Catalog Numbers ③④⑤		
			with Globe	with Type V 8" Refractor or G3 Globe ②	
Wall — Five Hubs, Four Close-Up Plugs					
	HPS	50	3/4	KPWBL5075	KPWBL5075J5
			1	KPWBL5010	KPWBL5010J5
	HPS	70	3/4	KPWBL7075	KPWBL7075J5
			1	KPWBL7010	KPWBL7010J5
HPS	100	3/4	KPWBL1075	KPWBL1075J5	
		1	KPWBL1010	KPWBL1010J5	
HPS	150	3/4	KPWBL1575	KPWBL1575J5	
		1	KPWBL1510	KPWBL1510J5	
25° Stanchion — One Hub					
	HPS	50	1-1/4	KPSL50125	KPSL50125J5
			1-1/2	KPSL50150	KPSL50150J5
	HPS	70	1-1/4	KPSL70125	KPSL70125J5
			1-1/2	KPSL70150	KPSL70150J5
HPS	100	1-1/4	KPSL10125	KPSL10125J5	
		1-1/2	KPSL10150	KPSL10150J5	
HPS	150	1-1/4	KPSL15125	KPSL15125J5	
		1-1/2	KPSL15150	KPSL15150J5	
90° Stanchion — One Hub					
	HPS	50	1-1/4	KPSTL50125	KPSTL50125J5
			1-1/2	KPSTL50150	KPSTL50150J5
	HPS	70	1-1/4	KPSTL70125	KPSTL70125J5
			1-1/2	KPSTL70150	KPSTL70150J5
HPS	100	1-1/4	KPSTL10125	KPSTL10125J5	
		1-1/2	KPSTL10150	KPSTL10150J5	
HPS	150	1-1/4	KPSTL15125	KPSTL15125J5	
		1-1/2	KPSTL15150	KPSTL15150J5	

② To order fixtures with large globe change **J5** to **G3**; for fixture with NEMA Type I or NEMA Type III refractor, change final digit 5 in catalog number to 1 or 3.
③ Add the following voltage and frequency designation before **Z2** suffix:

Lamp Type	Lamp Watts	Voltage Suffixes									
		MT	5MT	48	125	225	226	235	236	245	246
HPS	50	X	—	—	—	X	X	—	X	X	X
HPS	70	X	—	X	X	X	X	—	X	X	X
HPS	100	X	—	X	X	X	X	—	X	X	X
HPS	150	X	—	X	X	X	X	—	—	X	—
PSMH	70	X	—	X	X	X	—	—	—	X	—
PSMH	100	X	—	X	X	X	—	—	—	X	—
PSMH	150	X	—	X	X	X	—	—	—	X	—
PSMH	175	X	X	X	—	—	—	—	—	—	—
PSMH	200	X	—	X	—	—	—	—	—	—	X
PSMH	250	X	—	—	—	—	—	—	X	—	—

Voltages:
MT - 120/208/240/277 V 60 Hz **125** - 120 V 50 Hz **235** - 230 V 50 Hz
5MT - 120/208/240/277/480 V 60 Hz **225** - 225 V 50 Hz **236** - 230 V 60 Hz
48 - 480 V 60 Hz **226** - 220 V 60 Hz **245** - 240 V 50 Hz **246** - 240 V 60 Hz

④ Add **-Z2** suffix for factory sealed non-sparking/restricted breathing protection (AEx nA nR). Add **-ZB** suffix for restricted breathing protection (AEx nR).

⑤ For fixtures with guards, add letter **G** before adding voltage designation.

Mercmaster™ III HID 50–250 Watt Luminaires

70 W, 100 W, 150 W, 175 W, 200 W, 250 W PSMH

High Reactance, High Power Factor (min. P.F. 90%). Heat-Resistant Prismatic Glass Globe or Closed Prismatic Glass Refractor. Mogul Base Lamps

NEC/CEC:

Class I, Division 2, Groups A, B, C, D
 Class I, Zone 2, AEx nA nR IIC (Z2)
 Class I, Zone 2, AEx nR IIC (ZB)
 Class II, Division 1 and 2, Groups E, F, G
 Class III

NEC/CEC:

Simultaneous Exposure (Class I, Division 2)
 Class II, Division 1)
 Fixtures Outside Type (Salt Water)
 Type 4X
 IP66

	Lamp Type	Lamp Watts	Hub Size (Inches)	Catalog Numbers ③④⑤	
				with Globe	with Type V 8" Refractor ②
Pendant — One Hub, Rigid Mounting ①					
	PSMH	70	3/4 1	KPAH7075 KPAH7010	KPAH7075J5 KPAH7010J5
	PSMH	100	3/4 1	KPAH1075 KPAH1010	KPAH1075J5 KPAH1010J5
	PSMH	150	3/4 1	KPAP1575 KPAP1510	KPAP1575J5 KPAP1510J5
	PSMH	175	3/4 1	KPAP1775 KPAP1710	KPAP1775J5 KPAP1710J5
	PSMH	200	3/4 1	KPAP2075 KPAP2010	KPAP2075J5 KPAP2010J5
	PSMH	250 ⑥	3/4 1	KPAP2575 KPAP2510	KPAP2575J5 KPAP2510J5
Pendant Cone — One Hub, Rigid Mounting					
	PSMH	70	3/4 1	KPCHH7075 KPCHH7010	KPCHH7075J5 KPCHH7010J5
	PSMH	100	3/4 1	KPCHH1075 KPCHH1010	KPCHH1075J5 KPCHH1010J5
	PSMH	150	3/4 1	KPCHP1575 KPCHP1510	KPCHP1575J5 KPCHP1510J5
	PSMH	175	3/4 1	KPCHP1775 KPCHP1710	KPCHP1775J5 KPCHP1710J5
	PSMH	200	3/4 1	KPCHP2075 KPCHP2010	KPCHP2075J5 KPCHP2010J5
	PSMH	250 ⑥	3/4 1	KPCHP2575 KPCHP2510	KPCHP2575J5 KPCHP2510J5
Ceiling — Five Hubs, Four Close-Up Plugs					
	PSMH	70	3/4 1	KPCH7075 KPCH7010	KPCH7075J5 KPCH7010J5
	PSMH	100	3/4 1	KPCH1075 KPCH1010	KPCH1075J5 KPCH1010J5
	PSMH	150	3/4 1	KPCP1575 KPCP1510	KPCP1575J5 KPCP1510J5
	PSMH	175	3/4 1	KPCP1775 KPCP1710	KPCP1775J5 KPCP1710J5
	PSMH	200	3/4 1	KPCP2075 KPCP2010	KPCP2075J5 KPCP2010J5
	PSMH	250 ⑥	3/4 1	KPCP2575 KPCP2510	KPCP2575J5 KPCP2510J5

① For Flexible Pendant Mount, change **A** to **F** in catalog number (except 50 W HPS).

② To order fixtures with large globe change **J5** to **G3**; for fixture with NEMA Type I or NEMA Type III refractor, change final digit **5** in catalog number to **1** or **3**.

③ Add the following voltage and frequency designation before **Z2** suffix:

Lamp Type	Lamp Watts	MT	5MT	48	125	Voltage Suffixes					
						225	226	235	236	245	246
HPS	50	X	—	—	—	X	X	—	X	X	X
HPS	70	X	—	X	X	X	X	—	X	X	X
HPS	100	X	—	X	X	X	X	—	X	X	X
HPS	150	X	—	X	X	X	X	—	—	X	—
PSMH	70	X	—	X	X	X	—	—	—	X	—
PSMH	100	X	—	X	X	X	—	—	—	X	—
PSMH	150	X	—	X	X	X	—	—	—	X	—
PSMH	175	X	X	X	—	—	—	—	—	—	—
PSMH	200	X	—	X	—	—	—	—	—	—	X
PSMH	250	X	—	—	—	—	—	—	X	—	—

Voltages:

MT - 120/208/240/277 V 60 Hz

5MT - 120/208/240/277/480 V 60 Hz

48 - 480 V 60 Hz

125 - 120 V 50 Hz

225 - 225 V 50 Hz

226 - 220 V 60 Hz

235 - 230 V 50 Hz

236 - 230 V 60 Hz

245 - 240 V 50 Hz

246 - 240 V 60 Hz

④ Add **-Z2** suffix for factory sealed non-sparking/restricted breathing protection (AEx nA nR). Add **-ZB** suffix for restricted breathing protection (AEx nR).

⑤ For fixtures with guards, add letter **G** before adding voltage designation.

⑥ Available in MT and TT only. MT and TT 250W fixtures are not UL Listed.

Mercmaster™ III HID 50–250 Watt Luminaires

70 W, 100 W, 150 W, 175 W, 200 W, 250 W PSMH

High Reactance, High Power Factor (min. P.F. 90%). Heat-Resistant Prismatic Glass Globe or Closed Prismatic Glass Refractor. Mogul Base Lamps.

NEC/CEC:
 Class I, Division 2, Groups A, B, C, D
 Class I, Zone 2, AEx nA nR IIC (Z2)
 Class I, Zone 2, AEx nR IIC (ZB)
 Class II, Division 1 and 2, Groups E, F, G
 Class III

NEC/CEC:
 Simultaneous Exposure (Class I, Division 2/
 Class II, Division 1)
 Fixtures Outside Type (Salt Water)
 Type 4X
 IP66

Lamp Type	Lamp Watts	Hub Size (Inches)	Catalog Numbers ③④⑤		
			with Globe	with Type V 8" Refractor ②	
Wall — Five Hubs, Four Close-Up Plugs					
	PSMH	70	3/4 1	KPWBH7075 KPWBH7010	KPWBH7075J5 KPWBH7010J5
	PSMH	100	3/4 1	KPWBH1075 KPWBH1010	KPWBH1075J5 KPWBH1010J5
	PSMH	150	3/4 1	KPWBP1575 KPWBP1510	KPWBP1575J5 KPWBP1510J5
	PSMH	175	3/4 1	KPWBP1775 KPWBP1710	KPWBP1775J5 KPWBP1710J5
	PSMH	200	3/4 1	KPWBP2075 KPWBP2010	KPWBP2075J5 KPWBP2010J5
	PSMH	250 ⑥	3/4 1	KPWBP2575 KPWBP2510	KPWBP2575J5 KPWBP2510J5

25° Stanchion — One Hub					
	PSMH	70	1-1/4 1-1/2	KPSH70125 KPSH70150	KPSH70125J5 KPSH70150J5
	PSMH	100	1-1/4 1-1/2	KPSH10125 KPSH10150	KPSH10125J5 KPSH10150J5
	PSMH	150	1-1/4 1-1/2	KPSP15125 KPSP15150	KPSP15125J5 KPSP15150J5
	PSMH	175	1-1/4 1-1/2	KPSP17125 KPSP17150	KPSP17125J5 KPSP17150J5
	PSMH	200	1-1/4 1-1/2	KPSP20125 KPSP20150	KPSP20125J5 KPSP20150J5
	PSMH	250 ⑥	1-1/4 1-1/2	KPSP25125 KPSP25150	KPSP25125J5 KPSP25150J5

90° Stanchion — One Hub					
	PSMH	70	1-1/4 1-1/2	KPSTH70125 KPSTH70150	KPSTH70125J5 KPSTH70150J5
	PSMH	100	1-1/4 1-1/2	KPSTH10125 KPSTH10150	KPSTH10125J5 KPSTH10150J5
	PSMH	150	1-1/4 1-1/2	KPSTP15125 KPSTP15150	KPSTP15125J5 KPSTP15150J5
	PSMH	175	1-1/4 1-1/2	KPSTP17125 KPSTP17150	KPSTP17125J5 KPSTP17150J5
	PSMH	200	1-1/4 1-1/2	KPSTP20125 KPSTP20150	KPSTP20125J5 KPSTP20150J5
	PSMH	250 ⑥	1-1/4 1-1/2	KPSTP25125 KPSTP25150	KPSTP25125J5 KPSTP25150J5

Shown with Globe and Optional Guard

② To order fixtures with large globe change **J5** to **G3**; for fixture with NEMA Type I or NEMA Type III refractor, change final digit **5** in catalog number to **1** or **3**.

③ Add the following voltage and frequency designation before **Z2** suffix:

Lamp Type	Lamp Watts	MT	5MT	48	125	Voltage Suffixes					
						225	226	235	236	245	246
HPS	50	X	—	—	—	X	X	—	X	X	X
HPS	70	X	—	X	X	X	X	—	X	X	X
HPS	100	X	—	X	X	X	X	—	X	X	X
HPS	150	X	—	X	X	X	X	—	—	X	—
PSMH	70	X	—	X	X	X	—	—	—	X	—
PSMH	100	X	—	X	X	X	—	—	—	X	—
PSMH	150	X	—	X	X	X	—	—	—	X	—
PSMH	175	X	X	X	—	—	—	—	—	—	—
PSMH	200	X	—	X	—	—	—	—	—	—	X
PSMH	250	X	—	—	—	—	—	—	X	—	—

Voltages:

MT - 120/208/240/277 V 60 Hz

125 - 120 V 50 Hz

235 - 230 V 50 Hz

5MT - 120/208/240/277/480 V 60 Hz

225 - 225 V 50 Hz

236 - 230 V 60 Hz

48 - 480 V 60 Hz

226 - 220 V 60 Hz

245 - 240 V 50 Hz

246 - 240 V 60 Hz

④ Add **-Z2** suffix for factory sealed non-sparking/restricted breathing protection (AEx nA nR). Add **-ZB** suffix for restricted breathing protection (AEx nR).

⑤ For fixtures with guards, add letter **G** before adding voltage designation.

⑥ Available in MT and TT only. MT and TT 250W fixtures are not UL Listed.

Mercmaster™ III HID 50–250 Watt PRE-PAK™ Luminaires

Factory-Assembled Fixtures

For 70 W, 100 W or 150 W High Pressure Sodium Lamps, or 100 W or 175 W Pulse Start Metal Halide Lamps. Mogul Base Lamps.

NEC/CEC:

Class I, Division 2, Groups A, B, C, D
Class I, Zone 2, AEx nA nR IIC (Z2)
Class I, Zone 2, Ex nR IIC (Z)
Class I, Zone 2, AEx nR IIC (ZB)

NEC/CEC:

Class II, Division 1 and 2, Groups E, F, G
Class III
Simultaneous Exposure (Class I, Division 2/
Class II, Division 1)

NEC/CEC:

Fixtures Outside Type (Salt Water)
Type 4X
IP66

These pre-packaged fixture component combinations are delivered fully assembled and packed in a single carton. They are available with or without lamp, and with choice of globe or NEMA Type I, III or V refractors – all with or without guards. PRE-PAK units simplify ordering, stocking and shipping, and result in savings on job-site assembly and installation time and costs.

Catalog numbers do not include mounting hood or reflector. For mounting hood and reflectors selection, see below and order separately. Hood and Reflector will be packaged separately.



PRE-PAK Fixtures ①

Lamp Type and Watts	Ballast Assembly with Globe Only	Ballast Assembly with Globe and Guard	Ballast Assembly with G3 Globe Only	Ballast Assembly with Refractor Only ③	Ballast Assembly with Refractor and Guard
100 W PSMH ②	KPBU100H-MT	KPBU100HG-MT	—	KPBU100HJ5-MT	KPBU100HJ5G-MT
175 W PSMH	KPBU175P-MT	KPBU175PG-MT	—	KPBU175PJ5-MT	KPBU175PJ5G-MT
70 W HPS	KPBU70L-MT	KPBU70LG-MT	—	KPBU70LJ5-MT	KPBU70LJ5G-MT
100 W HPS	KPBU100L-MT	KPBU100LG-MT	KPBUG3100L-MT	KPBU100LJ5-MT	KPBU100LJ5G-MT
150 W HPS	KPBU150L-MT	KPBU150LG-MT	—	KPBU150LJ5-MT	KPBU150LJ5G-MT

Mounting Hoods

Description	Hub Size (Inches)	Catalog Number
Pendant One Hub, Rigid Mounting	3/4	KPA-75
	1	KPA-100
Pendant – Flexible One Hub, Flexible Mounting	3/4	KPAF-75
	1	KPAF-100
Pendant Cone One Hub, Rigid	3/4	KPCH-75
	1	KPCH-100
Ceiling Five Hubs, Four Close-Up Plugs	3/4	KPC-75
	1	KPC-100
Wall Five Hubs, Four Close-Up Plugs	3/4	KPWB-75
	1	KPWB-100
25° Stanchion One Hub	1-1/4	KPS-125
	1-1/2	KPS-150
90° Stanchion One Hub	1-1/4	KPST-125
	1-1/2	KPST-150

White Polyester Reflectors

Description	Catalog Number
Standard Dome For Globe Fixtures	KR2-ST
30° Angle For Globe Fixtures	KR2-AN
Standard Dome For Glass Refractor Fixtures	CMR-4ST
30° Angle For Glass Refractor Fixtures	CMR-4AN

① All catalog numbers above are fixtures without lamp. To order fixture complete with appropriate installed lamp, add suffix L to catalog number. All PRE-PAK fixtures include multi-tap ballast for operation on 120 V, 208 V, 240 V or 277 V lines. Fixture component combinations listed are furnished completely assembled in a single carton.

② 100 W fixtures use ED-28 mogul base lamps.

③ Refractor catalog numbers listed are for NEMA Type V. To order fixture with Type III refractor, change J5 in catalog number to J3; for Type I refractor, change J5 to J1.

Mercmaster™ III HID 50–250 Watt Luminaires





High Pressure Sodium and Pulse Start Metal Halide

Listed for simultaneous exposure to combustible dusts and flammable gases or vapors.

NEC/CEC:
 Class I, Division 2, Groups A, B, C, D
 Class I, Zone 2, AEx nA nR IIC (Z2)
 Class I, Zone 2, AEx nR IIC (ZB)
 Class II, Division 1 and 2, Groups E, F, G
 Class III

NEC/CEC:
 Simultaneous Exposure (Class I, Division 2/
 Class II, Division 1)
 Fixtures Outside Type (Salt Water)
 Type 4X
 IP66

Mounting Hoods

	Description	Hub Size (Inches)	Catalog Number
Pendant	 One Hub, Rigid Mounting	3/4	KPA-75
		1	KPA-100
Pendant — Flexible	 One Hub, Flexible Mounting	3/4	KPAF-75
		1	KPAF-100
Pendant Cone	 One Hub, Rigid	3/4	KPCH-75
		1	KPCH-100
Ceiling	 Five Hubs, Four Close-Up Plugs	3/4	KPC-75
		1	KPC-100
Wall	 Five Hubs, Four Close-Up Plugs	3/4	KPWB-75
		1	KPWB-100
25° Stanchion	 One Hub	1-1/4	KPS-125
		1-1/2	KPS-150
90° Stanchion	 One Hub	1-1/4	KPST-125
		1-1/2	KPST-150

Appleton

HID/AREA: NEC/CEC ENCLOSED AND GASKETED

Mercmaster™ III HID 50–250 Watt Luminaires

High Pressure Sodium and Pulse Start Metal Halide

Listed for simultaneous exposure to combustible dusts and flammable gases or vapors.

NEC/CEC:

Class I, Division 2, Groups A, B, C, D
 Class I, Zone 2, AEx nA nR IIC (Z2)
 Class I, Zone 2, AEx nR IIC (ZB)
 Class II, Division 1 and 2, Groups E, F, G
 Class III

NEC/CEC:

Simultaneous Exposure (Class I, Division 2/
 Class II, Division 1)
 Fixtures Outside Type (Salt Water)
 Type 4X
 IP66

Ballast Bodies



Ballast Body for Glass Globe (shown)

High Pressure Sodium
 High Power Factor (Min. P.F. 90%)



Ballast Body for Glass Refractor or G3 Globe (shown)

Pulse Start Metal Halide
 Super Constant Wattage Autotransformer (Min. P.F. 90%)

Lamp Type	Lamp Watts	Catalog Number ②④⑤		Voltage Suffixes									
		For Globe	For G3 Globe ①/ Refractor	MT	5MT	48	125	225	226	235	236	245	246
HPS	50 ③	KPB50L	KPBR50L	X	—	—	—	X	X	—	X	X	X
HPS	70 ③	KPB70L	KPBR70L	X	—	X	X	X	X	—	X	X	X
HPS	100 ③	KPB100L	KPBR100L	X	—	X	X	X	X	—	X	X	X
HPS	150 ③	KPB150L	KPBR150L	X	—	X	X	X	X	—	—	X	—
PSMH	70	KPB70H	KPBR70H	X	—	X	X	X	—	—	—	X	—
PSMH	100	KPB100H	KPBR100H	X	—	X	X	X	—	—	—	X	—
PSMH	150	KPB150P	KPBR150P	X	—	X	X	X	—	—	—	X	—
PSMH	175	KPB175P	KPBR175P	X	X	X	—	—	—	—	—	—	—
PSMH	200	KPB200P	KPBR200P	X	—	X	—	—	—	—	—	—	X
PSMH ⑥	250	KPBG250P	KPBR250P	X	—	—	—	—	—	—	X	—	—

Voltages:

- MT** - 120/208/240/277 V 60 Hz
- 5MT** - 120/208/240/277/480 V 60 Hz
- 48** - 480 V 60 Hz
- 125** - 120 V 50 Hz
- 225** - 225 V 50 Hz
- 226** - 220 V 60 Hz
- 235** - 230 V 50 Hz
- 236** - 240 V 50 Hz
- 245** - 240 V 50 Hz
- 246** - 240 V 60 Hz

① For HPS version fixtures only.
 ② After voltage suffix add: **-S** for Smart Starter.
 ③ After voltage suffix add: **-R** for ballast body with Hot Restrike Ignitor.
 ④ Add **-E** after voltage suffix for ballast body with provision for Quartz Emergency Light. Not suitable for hazardous locations.
 ⑤ Add **Z2** suffix for factory sealed non-sparking/restricted breathing protection (AEx nA nR). Add **ZB** suffix for restricted breathing protection (AEx nR).
 ⑥ MT ballast bodies are not UL Listed for 250W PSMH version fixtures only.





Mercmaster™ III HID 50–250 Watt Luminaires

High Pressure Sodium and Pulse Start Metal Halide

Listed for simultaneous exposure to combustible dusts and flammable gases or vapors.

NEC/CEC:
 Class I, Division 2, Groups A, B, C, D
 Class I, Zone 2, AEx nA nR IIC (Z2)
 Class I, Zone 2, AEx nR IIC (ZB)
 Class II, Division 1 and 2, Groups E, F, G
 Class III

NEC/CEC:
 Simultaneous Exposure (Class I, Division 2/
 Class II, Division 1)
 Fixtures Outside Type (Salt Water)
 Type 4X
 IP66

Description		Catalog Number
Prismatic Glass Globes — Heat-Resistant		
 Glass Globe	For use in areas where fixture is subject to extreme thermal shock Heat-Resistant	Clear VPGL-2HR
		Amber VPGL-2AM
		Blue VPGL-2BL
		Green VPGL-2GR
		Red VPGL-2RE
 G3 Glass Globe		Clear VPGL3HR
Tuff-Skin® Coated Prismatic Glass Globes — For Non-Classified Areas		
 Tuff-Skin® Glass Globe	For use in areas where fixture is subject to extreme thermal shock Heat-Resistant	Clear VPGL-2HRT
Polycarbonate Globes — Impact-Resistant ①		
 Polycarbonate Globe	Use 100 watt lamp max. Do not use in ambients exceeding 25 °C (77 °F).	Clear VPGL-2PL
		Amber VPGL-2AMPL
		Green VPGL-2GRPL
		Red VPGL-2REPL

① Polycarbonate globes are shatter-resistant – for use in processing plants, canneries, dairies, bakeries or anywhere broken glass would prove a hazard. Ideally suited for areas where vandalism, high replacement and high maintenance costs are a problem. Do not use in ambients exceeding +25 °C (+77 °F). For burning in vertical base-up positions only.

Mercmaster™ III HID 50–250 Watt Luminaires

High Pressure Sodium and Pulse Start Metal Halide







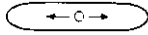

Listed for simultaneous exposure to combustible dusts and flammable gases or vapors.

NEC/CEC:

Class I, Division 2, Groups A, B, C, D
 Class I, Zone 2, AEx nA nR IIC (Z2)
 Class I, Zone 2, AEx nR IIC (ZB)
 Class II, Division 1 and 2, Groups E, F, G
 Class III

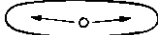
NEC/CEC:

Simultaneous Exposure (Class I, Division 2/
 Class II, Division 1)
 Fixtures Outside Type (Salt Water)
 Type 4X
 IP66

	Light Distribution	IES/NEMA Distribution Curves	Catalog Number
Closed Prismatic Glass Refractors — Heat-Resistant			
 Glass Refractor	NEMA Type I		LPG-R1
	NEMA Type III		LPG-R3
	NEMA Type V		LPG-R5
Closed Prismatic Polymeric Refractors			
For use with PSMH lamps, 100 W max. +40 °C (+104 °F) max. ambient temperature. Suitable for Class II, Division 1 and 2, Groups F, G; NEMA 4X, UL 1598A Marine Type Electric Fixtures Outside Type (Salt Water)			
 Polymeric Refractor	NEMA Type II		LPRF-2CP
	NEMA Type III		LPRF-3CP
	NEMA Type IV		LPRF-4CP
	NEMA Type V		LPRF-5CP

Appleton®

HID/AREA: NEC/CEC ENCLOSED AND GASKETED

Mercmaster™ III HID 50–250 Watt Luminaires

High Pressure Sodium and Pulse Start Metal Halide











Listed for simultaneous exposure to combustible dusts and flammable gases or vapors.

NEC/CEC:

Class I, Division 2, Groups A, B, C, D
 Class I, Zone 2, AEx nA nR IIC (Z2)
 Class I, Zone 2, AEx nR IIC (ZB)
 Class II, Division 1 and 2, Groups E, F, G
 Class III

NEC/CEC:

Simultaneous Exposure (Class I, Division 2/
 Class II, Division 1)
 Fixtures Outside Type (Salt Water)
 Type 4X
 IP66

Item	Description	Catalog Number
White Polyester Reflectors		
 Standard Dome	For Globe Fixtures	Standard Dome KR2-ST
	 30° Angle	Deep Dome KR2-DD ①
 Standard Dome		For Glass Refractor Fixtures ②
	 Standard Dome	Deep Dome CMR-4ST
 Standard Dome		Deep Dome CMR-4DD ①
	 Standard Dome	30° Angle CMR-4AN
Guards		
 Globe Guard		Globe Guard KGU2
 Refractor Guard		G3 Globe/Refractor Guard KRG2
Replacement Globe Gaskets – Silicone Rubber		
 Globe Gaskets		Globe Gasket VPGL-GK
		G3 Globe/Refractor Gasket KRF-GK
Retrofit Pendant Mounting Adapter		
 Mounting Adapter	Permits use of Mercmaster III pendant hood with 3/4" hub on existing V-51 mounting hood.	LPAD-1

① Dark Skies Compliant.

② Fixtures with refractors are not UL Listed when used with reflectors.

Mercmaster™ III HID 50–250 Watt Luminaires

High Pressure Sodium and Pulse Start Metal Halide

Listed for simultaneous exposure to combustible dusts and flammable gases or vapors.

NEC/CEC:

Class I, Division 2, Groups A, B, C, D
Class I, Zone 2, AEx nA nR IIC (Z2)
Class I, Zone 2, AEx nR IIC (ZB)
Class II, Division 1 and 2, Groups E, F, G
Class III

NEC/CEC:

Simultaneous Exposure (Class I, Division 2/
Class II, Division 1)
Fixtures Outside Type (Salt Water)
Type 4X
IP66

Ballast Housing Weights

Lamp Watts	HPS Wt. kg (lb) ①②	PSMH Wt. kg (lb) ①②
Globe Housing with Ballast		
50	5.7 (12.6)	—
70	6.8 (15.0)	6.9 (15.2)
100	7.3 (16.0)	7.4 (16.3)
175	—	7.8 (17.2)
200	—	8.2 (18.0)
250	—	8.4 (18.5)
Refractor Housing with Ballast		
70	7.0 (15.4)	7.1 (15.7)
100	7.5 (16.5)	7.6 (16.8)
150	7.9 (17.4)	7.8 (17.2)
175	—	8.1 (17.9)
200	—	8.4 (18.5)

Component and Accessory Weights

Item	Wt. kg (lb) ①
Mounting Hoods	
Pendant Cone	1.1 (2.43)
Ceiling	1.4 (3.09)
Wall	1.8 (3.97)
25° Stanchion	1.5 (3.31)
Straight Stanchion	1.7 (3.75)
8" Glass Refractor/G3 Globe	2.4 (5.29)
Glass Globe	1.7 (3.75)
Globe Guard	0.5 (1.10)
Refractor Guard	0.5 (1.10)
Reflectors	
30° Angle	1.1 (2.43)

Fuse Kits

Lamp Watts	Volts	Fuse Quantity Required	Fuse Kit Catalog Number	
			HPS	PSMH
50	120	1	F5	—
	208	2	F3	—
	240	2	F3	—
	277	1	F2	—
70	120	1	F5	F4
	208	2	F3	F3
	240	2	F3	F3
	277	1	F2	F2
100	480	2	F2	F1
	120	1	F8	F6
	208	2	F5	F4
	240	2	F5	F3
150	277	1	F3	F3
	480	2	F3	F2
	120	1	F10	—
	208	2	F5	—
175	240	2	F5	—
	277	1	F5	—
	480	2	F3	—
	120	1	—	F5
200	208	2	—	F3
	240	2	—	F3
	277	1	—	F2
	480	2	—	F2
250	120	1	—	F9
	208	2	—	F6
	240	2	—	F5
	277	1	—	F4
	480	2	—	F2
	120	1	—	F8
	208	2	—	F5
	240	2	—	F5
	277	1	—	F3

① Weights are approximate.

② Add 0.5 kg (1 lbs) for HPS fixtures with Hot Restrike. Add 0.1 kg (0.25 lbs) for Quartz Emergency Light.

Mercmaster™ III HID 50–250 Watt Luminaires

High Pressure Sodium and Pulse Start Metal Halide

Listed for simultaneous exposure to combustible dusts and flammable gases or vapors.

NEC/CEC:
 Class I, Division 2, Groups A, B, C, D
 Class I, Zone 2, AEx nA nR IIC (Z2)
 Class I, Zone 2, AEx nR IIC (ZB)
 Class II, Division 1 and 2, Groups E, F, G
 Class III

NEC/CEC:
 Simultaneous Exposure (Class I, Division 2/
 Class II, Division 1)
 Fixtures Outside Type (Salt Water)
 Type 4X
 IP66

Electrical Specifications

Line Voltage	Type of Ballast ①	StartingAmps	OperatingAmps	Total Watts
50 Watt High Pressure Sodium				
120	HX-HPF	0.58	0.58	64
208	HX-HPF	0.35	0.33	64
240	HX-HPF	0.31	0.29	64
277	HX-HPF	0.25	0.25	64
70 Watt High Pressure Sodium				
120	HX-HPF	0.90	0.82	94
208	HX-HPF	0.50	0.48	94
240	HX-HPF	0.44	0.41	94
277	HX-HPF	0.35	0.36	94
480	HX-HPF	0.21	0.21	94
100 Watt High Pressure Sodium				
120	HX-HPF	1.30	1.15	130
208	HX-HPF	0.76	0.67	130
240	HX-HPF	0.66	0.60	130
277	HX-HPF	0.60	0.52	130
480	HX-HPF	0.33	0.31	135
150 Watt High Pressure Sodium ②				
120	HX-HPF	2.00	1.70	188
208	HX-HPF	1.15	0.95	188
240	HX-HPF	1.00	0.85	188
277	HX-HPF	0.85	0.72	188
480	HX-HPF	0.50	0.47	189
70 Watt Pulse Start Metal Halide				
120	HX-HPF	0.80	0.85	95
208	HX-HPF	0.50	0.52	95
240	HX-HPF	0.43	0.44	95
277	HX-HPF	0.39	0.39	95
480	HX-HPF	0.26	0.23	95
100 Watt Pulse Start Metal Halide				
120	HX-HPF	1.20	1.15	130
208	HX-HPF	0.70	0.70	130
240	HX-HPF	0.61	0.58	130
277	HX-HPF	0.55	0.50	130
480	HX-HPF	0.30	0.35	140
150 Watt Pulse Start Metal Halide				
120	HX-HPF	1.75	1.60	188
208	HX-HPF	1.30	1.00	188
240	HX-HPF	0.85	0.80	188
277	HX-HPF	0.77	0.70	188
480	Super C.W.A.	0.45	0.42	185
175 Watt Pulse Start Metal Halide				
120	Super C.W.A.	0.90	1.78	199
208	Super C.W.A.	0.50	1.08	199
240	Super C.W.A.	0.35	0.89	199
277	Super C.W.A.	0.30	0.76	199
480	Super C.W.A.	0.25	0.50	213

① C.W.A. – Constant Wattage Autotransformer. HX-HPF – High Reactance High Power Factor Autotransformer. Super C.W.A. – Super Constant Wattage Autotransformer.
 ② 150 W HPS units equipped with ballasts to operate 55 volt lamps only.

Mercmaster™ III HID 50–250 Watt Luminaires

High Pressure Sodium and Pulse Start Metal Halide

Listed for simultaneous exposure to combustible dusts and flammable gases or vapors.

NEC/CEC:

Class I, Division 2, Groups A, B, C, D
 Class I, Zone 2, AEx nA nR IIC (Z2)
 Class I, Zone 2, AEx nR IIC (ZB)
 Class II, Division 1 and 2, Groups E, F, G
 Class III

NEC/CEC:

Simultaneous Exposure (Class I, Division 2/
 Class II, Division 1)
 Fixtures Outside Type (Salt Water)
 Type 4X
 IP66

Dimensions in Millimeters (Inches)

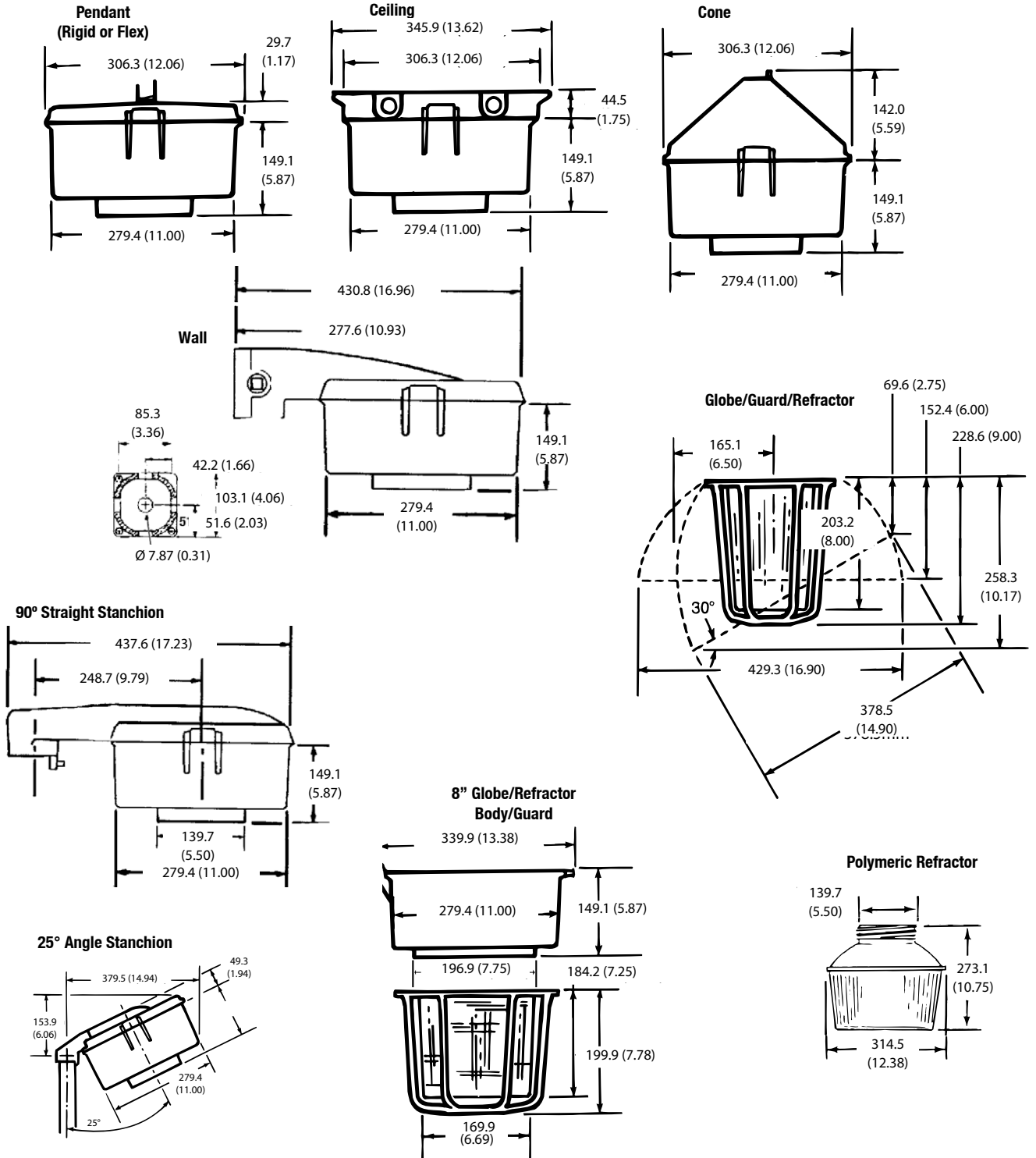

Appleton

HID/AREA: NEC/CEC ENCLOSED AND GASKETED

PCD2 Series Factory Sealed Hazardous Location Photocontrol

For use in Class I, Division 2, Groups A, B, C, D locations

Maintains Class I, Division 2 rating for Mercmaster III – Low Profile, Mercmaster III, and Mercmaster III – 400 Series Luminaires, Mercmaster LED

NEC/CEC:
Class I, Division 2, Groups A, B, C, D
NEMA 4X

Applications

- Encapsulated photocontrol provides automatic dusk-to-dawn lighting control in Class I, Division 2 locations.
- Typical applications include walkways, security areas and any other outdoor lighting application.
- For use with Mercmaster III – Low Profile, Mercmaster III, and Mercmaster III – 400 Series Luminaires.
- For remote mounting in FS Boxes.

- 50-400 W HID, incandescent or fluorescent, 50/60 Hz.
- 1000 V.A. Voltage/Ampere
- Minimum time delay: 15 seconds to eliminate nuisance tripping.
- Provided with (3) 18AWG stranded leads 152.4 mm (6 in) in length.
- Will fit through standard 1/2" knockout.
- Supplied with locknut and gasket.

Features



- Factory sealed design eliminates the need for an explosionproof enclosure.
- Can be easily installed in the field.
- Solid state design for performance and reliability.
- Available for 120, 208, 240, or 277 volts.

Materials

- Encapsulated with epoxy sealing compound
- FS: aluminum

NEC/CEC Certifications and Compliances

- UL Standard: 1604 – Hazardous (Classified) Locations
- cULus Recognized

	Voltage Range	Max VA	Max Current Amps	Suffix Designation Catalog Number
Factory-Installed Photocontrol - Not for ceiling or pendant cone. <i>Add to fixture catalog after voltage; i.e.: KPWBL1075MTH1.</i>				
	120 V, 50/60 Hz	1000	—	H1
	208 V, 50/60 Hz	1000	—	H2
	240 V, 50/60 Hz	1000	—	H3
	277 V, 50/60 Hz	1000	—	H4
Photocontrol for Field Installation				
	120 V, 50/60 Hz	1000	8.3 Amp	PC120D2
	208 V, 50/60 Hz	1000	4.8 Amp	PC247D2
	240 V, 50/60 Hz	1000	4.2 Amp	
	277 V, 50/60 Hz	1000	3.6 Amp	
Photocontrol in FS Cover for Use with FS/FD Box <i>Supplied with two stainless steel screws. For neoprene gasket, order catalog number FS-GKR-1N.</i>				
	120 V, 50/60 Hz	1000	8.3 Amp	FSKA-PC120D2
	208, 50/60 Hz	1000	4.8 Amp	FSKA-PC247D2
	240 V, 50/60 Hz	1000	4.2 Amp	
	277 V, 50/60 Hz	1000	3.6 Amp	

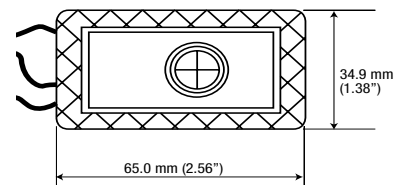
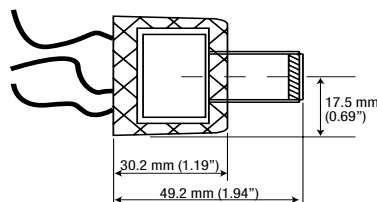
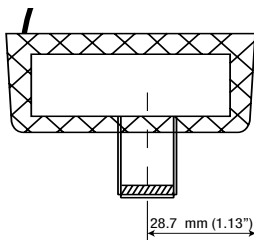

Mercmaster™ III HID 50–250 Watt Luminaires

150 W HPS

* Photometric data is based on fixtures with 150-watt clear High Pressure Sodium lamp (16,000 lumen). For candlepower values of fixtures with other HPS lamps, use the following multipliers: for 70 W (6,400 lumen) HPS lamp – 0.40; for 50 W (4,000 lumen) HPS lamp – 0.25. For candlepower values of fixture with guard, multiply by 0.95.

NEC/CEC:

Class I, Division 2, Groups A, B, C, D
 Class I, Zone 2, AEx nA nR IIC (Z2)
 Class I, Zone 2, AEx nR IIC (ZB)
 Class II, Division 1 and 2, Groups E, F, G
 Class III

NEC/CEC:

Simultaneous Exposure (Class I, Division 2)
 Class II, Division 1)
 Fixtures Outside Type (Salt Water)
 Type 4X
 IP66

Photometric Data

Zone	Lumens	Total Luminaire Efficiency = 86.1%	
0-10	50.74	CIE Type – Semi-Direct	
10-20	164.55	Plane	Spacing Criteria
20-30	310.47	0-180	2.82
30-40	611.05	90-270	2.82
40-50	961.13	Diagonal	2.80
50-60	1308.18	Zonal Lumen Summary	
60-70	1542.35	Zone	Lumens % Lamp % Fixture
70-80	1716.10	0-30	525.75 3.3 3.8
80-90	1799.18	0-40	1136.81 7.1 8.3
90-100	1802.19	0-60	3406.12 21.3 24.7
100-110	1676.86	0-90	8463.75 52.9 61.4
110-120	1379.11	90-120	4858.16 30.4 35.3
120-130	441.46	90-130	5299.62 33.1 38.5
130-140	9.61	90-150	5312.56 33.2 38.5
140-150	3.33	90-180	5313.30 33.2 38.6
150-160	0.74	180-0	13777.05 86.1 100.0
160-170	0.00		
170-180	0.00		

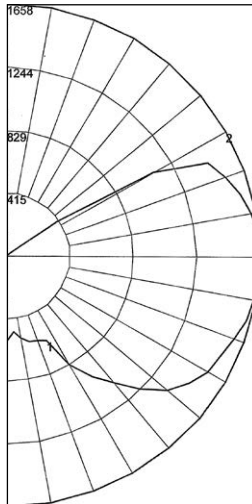

REPORT NUMBER: **KP15LG**

Lamps: 150 W High Pressure Sodium with Globe only *

Coefficients of Utilization – Zonal Cavity Method

Effective Floor Cavity Reflectance 0.20

% Ceiling Rcc	% Walls Rw	80		70		50		30		10		0						
		70	50	30	10	70	50	30	10	50	30		10					
0	95	95	95	95	89	89	89	89	77	77	77	67	67	67	57	57	57	53
1	81	74	69	64	75	69	64	59	59	55	51	50	47	44	42	39	37	33
2	71	62	54	47	65	57	50	44	49	43	38	41	36	32	33	30	27	23
3	64	52	44	37	58	48	41	34	41	35	30	34	29	25	28	24	20	17
4	57	45	36	30	53	42	34	28	35	29	24	29	24	20	24	19	16	13
5	52	40	31	24	48	37	29	23	31	24	19	26	20	16	21	16	13	10
6	48	35	26	20	44	32	25	19	27	21	16	23	17	13	18	14	11	8
7	44	31	23	17	40	29	21	16	24	18	14	20	15	11	16	12	9	7
8	40	28	20	15	37	26	19	14	22	16	12	18	13	10	15	11	8	6
9	38	25	18	13	35	24	17	12	20	14	10	17	12	8	14	10	7	5
10	35	23	16	11	32	22	15	11	18	13	9	15	11	7	13	9	6	4

Zone	Lumens	Total Luminaire Efficiency = 73.6%	
0-10	266.98	CIE Type – Direct	
10-20	799.41	Plane	Spacing Criteria
20-30	1337.05	0-180	1.46
30-40	1732.06	90-270	1.46
40-50	2067.60	Diagonal	1.68
50-60	2317.60	Zonal Lumen Summary	
60-70	2210.81	Zone	Lumens % Lamp % Fixture
70-80	866.77	0-30	2403.44 15.0 20.4
80-90	145.09	0-40	4135.50 25.8 35.1
90-100	14.46	0-60	8520.70 53.3 72.3
100-110	8.75	0-90	11743.37 73.4 99.7
110-120	7.93	90-120	31.14 0.2 0.3
120-130	4.51	90-130	35.65 0.2 0.3
130-140	2.16	90-150	38.29 0.2 0.3
140-150	0.48	90-180	38.29 0.2 0.3
150-160	0.00	180-0	11781.65 73.6 100.0
160-170	0.00		
170-180	0.00		

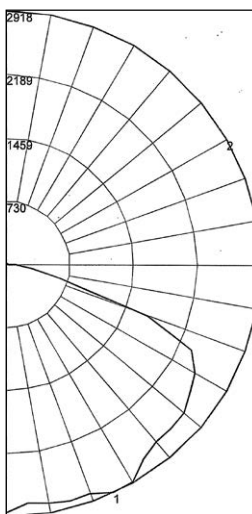

REPORT NUMBER: **KP15LST**

Lamps: 150 W High Pressure Sodium with Standard Dome Reflector *

Coefficients of Utilization – Zonal Cavity Method

Effective Floor Cavity Reflectance 0.20

% Ceiling Rcc	% Walls Rw	80		70		50		30		10		0						
		70	50	30	10	70	50	30	10	50	30		10					
0	88	88	88	88	86	86	86	86	82	82	82	78	78	78	75	75	75	73
1	79	76	72	69	77	74	71	68	71	68	66	68	66	64	65	64	62	60
2	71	65	59	55	69	63	58	54	61	57	53	58	55	52	56	53	50	49
3	64	56	49	44	62	55	49	44	52	47	43	50	46	42	48	45	41	40
4	58	49	42	36	57	48	41	36	46	40	36	44	39	35	42	38	35	33
5	53	43	36	31	52	42	35	30	40	35	30	39	34	30	38	33	29	28
6	49	38	31	26	47	38	31	26	36	30	26	35	30	25	34	29	25	24
7	45	34	27	23	44	34	27	23	33	27	22	31	26	22	30	26	22	20
8	42	31	24	20	40	31	24	20	30	24	20	29	23	19	28	23	19	18
9	39	28	22	18	38	28	22	18	27	21	17	26	21	17	25	21	17	16
10	36	26	20	16	35	26	20	16	25	19	16	24	19	16	23	19	15	14

Mercmaster™ III HID 50–250 Watt Luminaires

150 W HPS

* Photometric data is based on fixtures with 150-watt clear High Pressure Sodium lamp (16,000 lumen). For candlepower values of fixtures with other HPS lamps, use the following multipliers: for 70 W (6,400 lumen) HPS lamp – 0.40; for 50 W (4,000 lumen) HPS lamp – 0.25. For candlepower values of fixture with guard, multiply by 0.95.

NEC/CEC:
 Class I, Division 2, Groups A, B, C, D
 Class I, Zone 2, AEx nA nR IIC (Z2)
 Class I, Zone 2, AEx nR IIC (ZB)
 Class II, Division 1 and 2, Groups E, F, G
 Class III

NEC/CEC:
 Simultaneous Exposure (Class I, Division 2)
 Class II, Division 1)
 Fixtures Outside Type (Salt Water)
 Type 4X
 IP66

Photometric Data

Zone Lumens Total Luminaire Efficiency = 73.1%

Zone	Lumens	CIE Type – Direct	
		Plane	Spacing Criteria
0-10	222.62		
10-20	664.6		
20-30	1084.32		
30-40	1536.55	0-180	2.06
40-50	1771.90	90-270	1.58
50-60	1771.51	Diagonal	1.62

Zonal Lumen Summary			
Zone	Lumens	% Lamp	% Fixture
0-30	1971.54	12.3	16.9
0-40	3508.09	21.9	30.0
0-60	7051.50	44.1	60.3
0-90	11137.33	69.6	95.2
90-120	557.80	3.5	4.8
90-130	559.01	3.5	4.8
90-150	559.04	3.5	4.8
90-180	559.04	3.5	4.8
180-0	11696.38	73.1	100.0

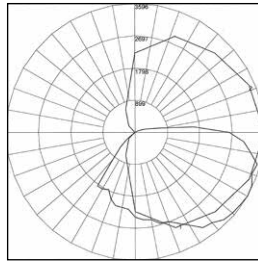

REPORT NUMBER: **KP15LAN**

Lamps: 150 W High Pressure Sodium with
 30° Angle Dome Reflector *

Coefficients of Utilization – Zonal Cavity Method

Effective Floor Cavity Reflectance 0.20

% Ceiling Rcc	% Walls Rw	80		70		50		30		10		0						
		70	50	30	10	70	50	30	10	50	30	10	0					
0	86	86	86	86	84	84	84	84	79	79	79	75	75	75	71	71	71	70
1	76	71	67	63	73	69	65	62	65	62	59	62	59	57	58	56	54	52
2	68	60	54	49	65	58	53	48	55	50	46	52	48	45	49	46	43	41
3	61	52	45	39	59	50	44	39	48	42	37	45	40	36	43	39	35	33
4	55	45	38	32	53	44	37	32	42	36	31	39	34	30	37	33	29	27
5	50	40	33	27	49	39	32	27	37	31	26	35	30	25	33	29	25	23
6	46	36	28	23	45	35	28	23	33	27	22	31	26	22	30	25	21	20
7	43	32	25	20	41	31	25	20	30	24	19	28	23	19	27	22	19	17
8	40	29	22	18	38	28	22	17	27	21	17	26	21	17	25	20	16	15
9	37	26	20	16	36	26	20	16	25	19	15	24	19	15	23	18	15	13
10	35	24	18	14	33	24	18	14	23	17	14	22	17	13	21	16	13	12

Zone Lumens Total Luminaire Efficiency = 81.1%

Zone	Lumens	CIE Type – Semi-Direct	
		Plane	Spacing Criteria
0-10	72.83		
10-20	222.26		
20-30	380.73		
30-40	621.11	0-180	1.98
40-50	852.53	90-270	1.98
50-60	1765.29	Diagonal	3.40

Zonal Lumen Summary			
Zone	Lumens	% Lamp	% Fixture
0-30	675.83	4.2	5.2
0-40	1296.93	8.1	10.0
0-60	3914.76	24.5	30.2
0-90	10704.60	66.9	82.5
90-120	1661.70	10.4	12.8
90-130	1985.14	12.4	15.3
90-150	2251.45	14.1	15.3
90-180	2275.34	14.2	17.5
180-0	12979.94	81.1	100.0

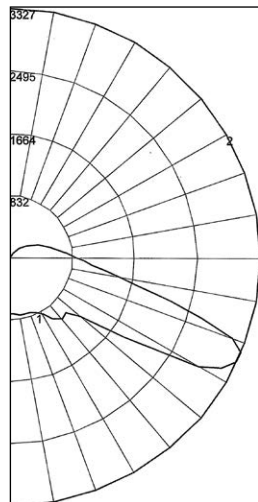

REPORT NUMBER: **KP15LJR5**

Lamps: 150 W High Pressure Sodium with
 8" Prismatic Glass Refractor – NEMA Type V *

Coefficients of Utilization – Zonal Cavity Method

Effective Floor Cavity Reflectance 0.20

% Ceiling Rcc	% Walls Rw	80		70		50		30		10		0						
		70	50	30	10	70	50	30	10	50	30	10	0					
0	93	93	93	93	89	89	89	89	82	82	82	76	76	76	70	70	70	67
1	80	73	68	63	76	70	65	61	64	60	56	58	55	52	53	50	48	45
2	69	59	51	45	65	56	49	43	51	45	40	46	41	37	41	37	34	31
3	61	49	40	33	57	47	38	32	42	35	29	38	32	27	34	29	25	22
4	54	42	32	25	51	40	31	24	35	28	22	32	26	21	28	23	19	16
5	49	36	27	20	46	34	26	19	31	23	18	27	21	16	24	19	15	12
6	45	32	23	16	42	30	22	16	27	20	14	24	18	13	21	16	12	10
7	41	28	20	14	38	27	19	13	24	17	12	21	15	11	19	14	10	8
8	38	25	17	12	36	24	16	11	22	15	10	19	14	9	17	12	8	6
9	35	23	15	10	33	22	15	10	20	13	9	18	12	8	16	11	7	5
10	33	21	14	9	31	20	13	9	18	12	8	16	11	7	15	10	6	5

Mercmaster™ III HID 50–250 Watt Luminaires

175 W PSMH

* Photometric data is based on fixtures with a 175-watt clear Pulse Start Metal Halide lamp (17,500 lumen). For candlepower values of fixtures with other PSMH lamps, use the following multipliers: for a 100 W (8,500 lumen) PSMH lamp – 0.49; for a 70 W (6,200 lumen) PSMH lamp – 0.36; for a 200 W (21,000 lumen) PSMH lamp – 1.2. For candlepower values of fixture with guard, multiply by 0.95.

NEC/CEC:
 Class I, Division 2, Groups A, B, C, D
 Class I, Zone 2, AEx nA nR IIC (Z2)
 Class I, Zone 2, AEx nR IIC (ZB)
 Class II, Division 1 and 2, Groups E, F, G
 Class III

NEC/CEC:
 Simultaneous Exposure (Class I, Division 2)
 Class II, Division 1)
 Fixtures Outside Type (Salt Water)
 Type 4X
 IP66

Photometric Data

Zone Lumens Total Luminaire Efficiency = 75.4%

Zone	Lumens	CIE Type – General Diffuse
0-10	57.98	
10-20	217.30	
20-30	372.71	
30-40	696.29	
40-50	1009.65	
50-60	1226.57	
60-70	1473.76	
70-80	1757.30	
80-90	1902.34	
90-100	1946.09	
100-110	1829.51	
110-120	1657.20	
120-130	750.27	
130-140	14.15	
140-150	4.47	
150-160	0.52	
160-170	1.35	
170-180	0.18	

Zonal Lumen Summary			
Zone	Lumens	% Lamp	% Fixture
0-30	647.99	3.7	4.3
0-40	1344.28	7.7	9.0
0-60	3580.49	20.5	24.0
0-90	8713.89	49.8	58.4
90-120	5432.80	31.0	36.4
90-130	6183.06	35.3	41.4
90-150	6201.69	35.4	41.6
90-180	6203.74	35.4	41.6
180-0	14917.63	85.2	100.0

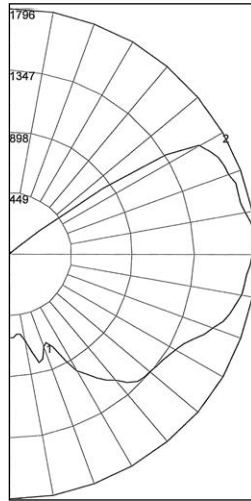

REPORT NUMBER: **KP17PG**

Lamps: 175 W Pulse Start Metal Halide with Globe only *

Coefficients of Utilization – Zonal Cavity Method

Effective Floor Cavity Reflectance 0.20

% Ceiling Rcc	% Walls	Rw	80				70				50				30				10				0
			70	50	30	10	70	50	30	10	50	30	10	0	50	30	10	0	50	30	10	0	
0	93	93	93	93	93	87	87	87	87	75	75	75	64	64	64	54	54	54	50	0			
1	79	73	68	63	58	73	68	63	59	58	54	50	48	45	43	40	37	35	31	0			
2	70	61	54	47	42	65	57	50	44	48	42	38	39	35	32	32	29	26	22	0			
3	63	52	44	37	32	58	48	41	35	40	34	29	33	28	24	27	23	20	16	0			
4	57	45	37	30	26	52	42	34	28	35	29	24	29	24	20	23	19	16	12	0			
5	52	40	31	25	21	47	37	29	23	31	24	20	25	20	16	20	16	13	10	0			
6	47	35	27	21	18	43	32	25	19	27	21	17	22	17	14	18	14	11	8	0			
7	44	31	23	18	15	40	29	22	17	24	18	14	20	15	12	16	12	9	7	0			
8	40	28	21	15	12	37	26	19	14	22	16	12	18	14	10	15	11	8	6	0			
9	37	26	18	13	10	34	24	17	13	20	15	11	17	12	9	13	10	7	5	0			
10	35	23	16	12	9	32	22	15	11	18	13	9	15	11	8	12	9	6	4	0			

Zone Lumens Total Luminaire Efficiency = 72.3%

Zone	Lumens	CIE Type – Direct
0-10	285.95	
10-20	876.46	
20-30	1472.88	
30-40	1924.39	
40-50	2213.42	
50-60	2305.55	
60-70	2256.32	
70-80	1115.75	
80-90	198.05	
90-100	3.56	
100-110	0.00	
110-120	0.00	
120-130	0.00	
130-140	0.00	
140-150	0.00	
150-160	0.00	
160-170	0.00	
170-180	0.00	

Plane	Spacing Criteria
0-180	1.50
90-270	1.50
Diagonal	1.66

Zonal Lumen Summary			
Zone	Lumens	% Lamp	% Fixture
0-30	2635.28	15.1	20.8
0-40	4559.67	26.1	36.0
0-60	9078.64	51.9	71.8
0-90	12648.77	72.3	100.0
90-120	3.56	0.00	0.00
90-130	3.56	0.00	0.00
90-150	3.56	0.00	0.00
90-180	3.56	0.00	0.00
180-0	12652.33	72.3	100.0

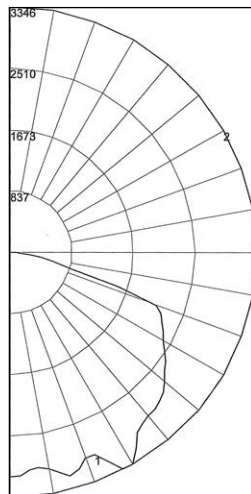

REPORT NUMBER: **KP17PST**

Lamps: 175 W Pulse Start Metal Halide with Standard Dome Reflector *

Coefficients of Utilization – Zonal Cavity Method

Effective Floor Cavity Reflectance 0.20

% Ceiling Rcc	% Walls	Rw	80				70				50				30				10				0
			70	50	30	10	70	50	30	10	50	30	10	0	50	30	10	0	50	30	10	0	
0	86	86	86	86	86	84	84	84	84	80	80	80	77	77	77	74	74	74	72	0			
1	78	74	71	68	65	76	72	69	67	69	67	65	67	64	63	64	62	61	59	0			
2	70	63	58	54	50	68	62	57	53	59	55	52	57	54	50	55	52	49	48	0			
3	63	55	48	43	39	61	54	48	43	51	46	42	49	45	41	47	44	41	39	0			
4	57	48	41	36	32	56	47	40	35	45	39	35	43	38	34	42	37	34	32	0			
5	52	42	35	30	26	51	41	35	30	40	34	30	38	33	29	37	32	29	27	0			
6	48	38	31	26	22	47	37	30	26	36	30	25	34	29	25	33	29	25	23	0			
7	44	34	27	22	18	43	33	27	22	32	26	22	31	26	22	30	25	22	20	0			
8	41	31	24	20	16	40	30	24	20	29	24	19	28	23	19	27	23	19	18	0			
9	38	28	22	18	14	37	28	22	17	27	21	17	26	21	17	25	21	17	16	0			
10	36	26	20	16	12	35	25	20	16	25	19	16	24	19	15	23	19	15	14	0			

HID/AREA: NEC/CEC ENCLOSED AND GASKETED

Mercmaster™ III HID 50–250 Watt Luminaires

175 W PSMH

* Photometric data is based on fixtures with a 175-watt clear Pulse Start Metal Halide lamp (17,500 lumen). For candlepower values of fixtures with other PSMH lamps, use the following multipliers: for a 100 W (8,500 lumen) PSMH lamp – 0.49; for 70 W (6,200 lumen) PSMH lamp – 0.36; for a 200 W (21,000 lumen) PSMH lamp – 1.2. For candlepower values of fixture with guard, multiply by 0.95.

NEC/CEC:
 Class I, Division 2, Groups A, B, C, D
 Class I, Zone 2, AEx nA nR IIC (Z2)
 Class I, Zone 2, AEx nR IIC (ZB)
 Class II, Division 1 and 2, Groups E, F, G
 Class III

NEC/CEC:
 Simultaneous Exposure (Class I, Division 2)
 Class II, Division 1)
 Fixtures Outside Type (Salt Water)
 Type 4X
 IP66

Photometric Data

Zone Lumens Total Luminaire Efficiency = 67.1%

Zone	Lumens	CIE Type – Direct	
		Plane	Spacing Criteria
0-10	240.21		
10-20	750.99		
20-30	1195.39		
30-40	1662.85	0-180	1.96
40-50	1830.67	90-270	1.70
50-60	1740.13	Diagonal	1.56
60-70	1571.75		
70-80	1324.18		
Zonal Lumen Summary			
Zone	Lumens	% Lamp	% Fixture
0-30	2186.59	12.5	18.6
0-40	3849.44	22.0	32.8
0-60	7420.24	42.4	63.2
0-90	11216.82	64.1	95.6
90-100	367.96		
100-110	107.38	0-40	3849.44
110-120	27.79	0-60	7420.24
120-130	5.54	0-90	11216.82
130-140	4.20	90-120	503.12
140-150	4.42	90-130	508.66
150-160	2.00	90-150	517.28
160-170	1.70	90-180	521.31
170-180	0.33	180-0	11738.13
		11738.13	67.1
			100.0

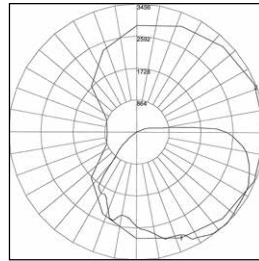

REPORT NUMBER: **KP17PAN**

Lamps: 175 W Pulse Start Metal Halide with
 30° Angle Dome Reflector *

Coefficients of Utilization – Zonal Cavity Method

Effective Floor Cavity Reflectance 0.20

% Ceiling Rcc	% Walls Rw	80		70		50		30		10		0						
		70	50	30	10	70	50	30	10	50	30		10					
0	79	79	79	79	77	77	77	77	73	73	73	69	69	69	66	66	66	64
1	70	66	62	59	68	64	61	58	60	58	55	57	55	53	54	52	51	49
2	63	56	51	46	61	55	49	45	52	47	44	49	45	42	46	43	41	39
3	57	48	42	37	55	47	41	37	45	40	36	42	38	35	40	37	34	32
4	51	42	36	31	50	41	35	30	39	34	30	37	33	29	35	31	28	26
5	47	38	31	26	45	37	30	26	35	29	25	33	28	25	32	27	24	22
6	43	34	27	22	42	33	27	22	31	26	22	30	25	21	28	24	21	19
7	40	30	24	20	39	30	24	19	28	23	19	27	22	19	26	22	18	17
8	37	27	21	17	36	27	21	17	26	20	17	25	20	16	24	19	16	15
9	35	25	19	15	33	25	19	15	24	18	15	23	18	15	22	18	14	13
10	32	23	17	14	31	23	17	14	22	17	13	21	16	13	20	16	13	12

Zone Lumens Total Luminaire Efficiency = 81.1%

Zone	Lumens	CIE Type – Semi-Direct	
		Plane	Spacing Criteria
0-10	22.77		
10-20	171.20		
20-30	325.41		
30-40	531.35	0-180	1.66
40-50	1173.62	90-270	1.64
50-60	1165.11	Diagonal	1.92
60-70	3171.29		
70-80	3719.35		
Zonal Lumen Summary			
Zone	Lumens	% Lamp	% Fixture
0-30	519.38	3.0	3.7
0-40	1050.73	6.0	7.4
0-60	3389.46	19.4	23.9
0-90	12031.16	68.7	84.8
90-100	523.23		
100-110	716.53	0-40	1050.73
110-120	431.18	0-60	3389.46
120-130	265.20	0-90	12031.16
130-140	142.69	90-120	1670.94
140-150	57.09	90-130	1936.15
150-160	13.48	90-150	2135.93
160-170	2.44	90-180	2152.72
170-180	0.88	180-0	14183.88
		14183.88	81.1
			100.0

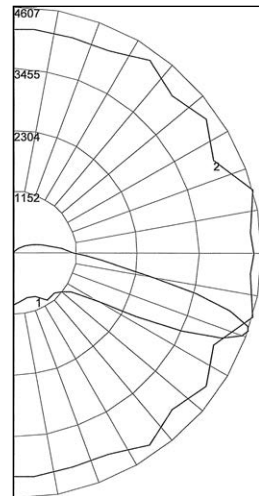

REPORT NUMBER: **KP17PJR5**

Lamps: 175 W Pulse Start Metal Halide with
 8" Prismatic Glass Refractor – NEMA Type V *

Coefficients of Utilization – Zonal Cavity Method

Effective Floor Cavity Reflectance 0.20

% Ceiling Rcc	% Walls Rw	80		70		50		30		10		0						
		70	50	30	10	70	50	30	10	50	30		10					
0	94	94	94	94	90	90	90	90	83	83	83	77	77	77	71	71	71	69
1	78	71	65	60	74	68	62	57	62	57	53	57	53	49	51	48	46	43
2	67	57	48	41	63	54	46	39	49	42	36	44	38	33	39	35	31	28
3	59	46	37	29	55	44	35	28	40	32	26	35	29	24	32	26	22	19
4	52	39	30	22	49	37	28	21	33	26	20	30	23	18	26	21	16	14
5	47	34	24	17	45	32	23	17	29	21	15	26	19	14	23	17	13	10
6	43	30	21	14	41	28	20	14	25	18	12	23	16	11	20	15	10	8
7	40	27	18	12	37	23	17	11	23	16	10	20	14	9	18	13	8	6
8	37	24	16	10	35	23	15	10	20	14	9	18	12	8	16	11	7	5
9	34	22	14	9	32	21	13	8	19	12	8	17	11	7	15	10	6	4
10	32	20	12	8	30	19	12	7	17	11	7	16	10	6	14	9	5	4

Mercmaster™ III HID 50–250 Watt Luminaires

175 W PSMH

* Photometric data is based on fixtures with a 175-watt clear Pulse Start Metal Halide lamp (17,500 lumen). For candlepower values of fixtures with other PSMH lamps, use the following multipliers: for a 100 W (8,500 lumen) PSMH lamp – 0.49; for a 70 W (6,200 lumen) PSMH lamp – 0.36; for a 200 W (21,000 lumen) PSMH lamp – 1.2. For candlepower values of fixture with guard, multiply by 0.95.

NEC/CEC:
 Class I, Division 2, Groups A, B, C, D
 Class I, Zone 2, AEx nA nR IIC (Z2)
 Class I, Zone 2, AEx nR IIC (ZB)
 Class II, Division 1 and 2, Groups E, F, G
 Class III

NEC/CEC:
 Simultaneous Exposure (Class I, Division 2/
 Class II, Division 1)
 Fixtures Outside Type (Salt Water)
 Type 4X
 IP66

Photometric Data

Degree	Candela	Lumens
0	657	
5	668	65
15	784	224
25	966	451
35	1194	705
45	871	711
55	1267	1142
65	1309	1303
75	1430	1509
85	1528	1661
90	1537	
95	1552	1680
105	1452	1532
115	1339	1232
125	68	143
135	19	16
145	13	11
155	7	3
165	1	1
175	2	0
180	7	

TOTAL LUMINAIRE EFFICIENCY = 70.8%
CIE Type – Semi-Direct
 Spacing Criteria: 1.7

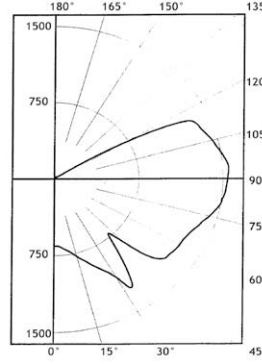

ZONAL LUMEN SUMMARY

ZONE	LUMENS	%LAMP	%FIXT.
0-30	740	4.2	6.0
0-40	1445	8.3	11.7
0-60	3297	18.8	26.6
0-90	7770	44.4	62.7
90-120	4444	25.4	35.9
90-130	4586	26.2	37.0
90-150	4613	26.4	37.2
90-180	4617	26.4	37.3
0-180	12387	70.8	100.0

REPORT NUMBER: KPB175PG3
 Lamps: 175 W Pulse Start Metal Halide ED28 Mogul Base with G3 Globe only

COEFFICIENTS OF UTILIZATION – ZONAL CAVITY METHOD

EFFECTIVE FLOOR CAVITY REFLECTANCE 0.20

RC	80			70			50			30			10			0		
	RW	70	50	30	10	0	RW	70	50	30	10	0	RW	70	50		30	10
0	78	78	78	78	73	73	73	73	64	64	64	56	56	56	48	48	48	44
1	67	61	57	53	62	57	53	49	49	46	43	42	39	37	35	33	31	28
2	59	51	45	40	54	48	42	37	41	36	32	34	31	27	28	26	23	20
3	53	44	37	31	49	40	34	29	34	29	25	29	25	21	24	21	18	15
4	48	38	31	25	44	35	29	24	30	25	20	25	21	17	21	17	14	12
5	43	33	26	21	40	31	24	20	26	21	17	22	18	14	18	15	12	9
6	40	29	23	18	37	27	21	16	23	18	14	20	15	12	16	13	10	8
7	37	26	20	15	34	25	18	14	21	16	12	18	13	10	15	11	9	7
8	34	24	17	13	31	22	16	12	19	14	11	16	12	9	13	10	7	6
9	32	22	16	11	29	20	15	11	17	13	9	15	11	8	12	9	7	5
10	29	20	14	10	27	18	13	9	16	11	8	14	10	7	11	8	6	4

Degree	Candela	Lumens
0	2785	
5	2797	269
15	2902	823
25	2931	1358
35	2979	1821
45	2388	1874
55	2393	2145
65	2044	2034
75	664	856
85	150	183
90	24	
95	5	11
105	16	17
115	91	73
125	5	9
135	7	3
145	8	2
155	2	2
165	2	0
175	2	1
180	11	

TOTAL LUMINAIRE EFFICIENCY = 65.6%
CIE Type – Direct
 Spacing Criteria: 1.5

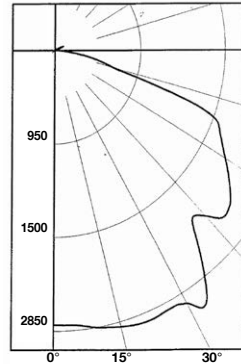

ZONAL LUMEN SUMMARY

ZONE	LUMENS	%LAMP	%FIXT.
0-30	2450	14.0	21.3
0-40	4271	24.4	37.2
0-60	8290	47.4	72.2
0-90	11363	64.9	99.0
90-120	101	0.6	0.9
90-130	110	0.6	1.0
90-150	115	0.7	1.0
90-180	118	0.7	1.0
0-180	11481	65.6	100.0

REPORT NUMBER: KPB175PG3_ST
 Lamps: 175 W Pulse Start Metal Halide ED28 Mogul Base with G3 Globe and Standard Dome Reflector

COEFFICIENTS OF UTILIZATION – ZONAL CAVITY METHOD

EFFECTIVE FLOOR CAVITY REFLECTANCE 0.20

RC	80			70			50			30			10			0		
	RW	70	50	30	10	0	RW	70	50	30	10	0	RW	70	50		30	10
0	78	78	78	78	76	76	76	73	73	73	69	69	69	66	66	66	66	65
1	71	67	64	62	69	66	63	61	63	61	59	60	58	57	58	56	55	53
2	64	58	53	49	62	57	52	48	54	50	47	52	49	46	50	47	45	43
3	58	50	44	40	56	49	44	39	47	42	39	45	41	38	43	40	37	35
4	52	44	38	33	51	43	37	33	41	36	32	39	35	32	38	34	31	29
5	48	39	32	28	46	38	32	28	36	31	27	35	30	27	34	30	26	25
6	44	35	28	24	42	34	28	24	33	27	23	31	27	23	30	26	23	21
7	40	31	25	21	39	30	25	21	29	24	20	28	24	20	27	23	20	19
8	37	28	22	18	36	28	22	18	27	22	18	26	21	18	25	21	18	16
9	35	26	20	16	34	25	20	16	24	19	16	24	19	16	23	19	16	15
10	33	24	18	15	32	23	18	15	23	18	14	22	17	14	21	17	14	13

Candela Distribution

0.0	45.0	90.0	135.0	180.0	Flux	
0	2333	2333	2333	2333	2333	
5	2491	2467	2321	2205	2141	223
15	2904	2753	2337	2160	2099	692
25	3010	2891	2480	2242	2120	1170
35	3471	3100	2544	2027	1367	1512
45	2978	2719	1993	832	546	1427
55	3296	2939	1791	421	154	1533
65	3153	2801	776	74	0	1349
75	3175	2621	392	3	0	1140
85	2729	967	117	5	0	709
90	1601	662	11	5	5	
95	790	461	3	11	16	247
105	413	175	11	19	21	109
115	117	8	8	29	90	56
125	5	11	13	13	11	2
135	0	3	3	3	0	1
145	5	5	11	5	0	4
155	0	3	5	5	0	2
165	5	3	8	5	0	1
175	0	5	3	3	0	0
180	6	6	6	6	6	

TOTAL LUMINAIRE EFFICIENCY = 58.2%
CIE Type – Direct
 Spacing Criteria
 Plane Criteria
 0° 1.8
 90° 1.5
 180° 1.1

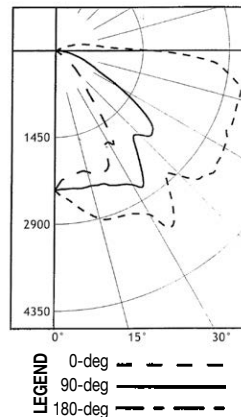

ZONAL LUMEN SUMMARY

ZONE	LUMENS	%LAMP	%FIXT.
0-30	2085	11.9	20.5
0-40	3597	20.6	35.3
0-60	6557	37.5	64.4
0-90	9755	55.7	95.8
90-120	412	2.4	4.1
90-130	415	2.4	4.1
90-150	420	2.4	4.1
90-180	423	2.4	4.2
0-180	10178	58.2	100.0

REPORT NUMBER: KPB175PG3_AN
 Lamps: 175 W Pulse Start Metal Halide ED28 Mogul Base with G3 Globe and 30° Angle Dome Reflector

COEFFICIENTS OF UTILIZATION – ZONAL CAVITY METHOD

EFFECTIVE FLOOR CAVITY REFLECTANCE 0.20

RC	80			70			50			30			10			0		
	RW	70	50	30	10	0	RW	70	50	30	10	0	RW	70	50		30	10
0	69	69	69	69	67	67	67	63	63	63	60	60	60	57	57	57	56	
1	61	57	54	51	59	56	53	50	53	50	48	50	48	46	48	46	45	43
2	55	49	44	40	53	48	43	40	45	42	38	43	40	37	41	38	36	34
3	49	42	37	33	48	41	36	32	39	35	31	37	34	31	35	32	30	28
4	45	37	32	27	43	36	31	27	34	30	26	33	29	26	31	28	25	24
5	41	33	27	23	40	32	27	23	31	26	22	29	25	22	28	24	21	20
6	38	30	24	20	37	29	24	20	28	23	19	26	22	19	25	22	19	17
7	35	27	21	18	34	26	21	17	25	20	17	24	20	17	23	19	16	15
8	33	24	19	16	32	24	19	15	23	18	15	22	18	15	21	17	15	13
9	30	22	17	14	29	22	17	14	21	17	14	20	16	13	19	16	13	12
10	28	20	16	12	28	20	15	12	19	15	12	19	15	12	18	14	12	11

Mercmaster™ III HID 50–250 Watt Luminaires

100 W HPS

* Photometric data is based on fixtures with a 100-watt clear High Pressure Sodium lamp (9,400 lumen). For candlepower values of fixtures with other HPS lamps, use the following multipliers: for a 70 W (6,400 lumen) HPS lamp – 0.68; for 50 W (4,000 lumen) HPS lamp – 0.43; for candlepower values of fixture with guard, multiply by 0.95.

NEC/CEC:

Class I, Division 2, Groups A, B, C, D
 Class I, Zone 2, AEx nA nR IIC (Z2)
 Class I, Zone 2, AEx nR IIC (ZB)
 Class II, Division 1 and 2, Groups E, F, G
 Class III

NEC/CEC:

Simultaneous Exposure (Class I, Division 2/
 Class II, Division 1)
 Fixtures Outside Type (Salt Water)
 Type 4X
 IP66

Photometric Data

Degree	Candela	Lumens
0	269	
5	267	27
15	407	117
25	571	267
35	748	442
45	451	380
55	848	735
65	915	908
75	976	1033
85	1021	1113
90	1027	
95	1019	1109
105	953	1002
115	791	734
125	54	103
135	13	9
145	13	8
155	4	2
165	0	0
175	0	0
180	1	

TOTAL LUMINAIRE EFFICIENCY = 84.1%

CIE Type – Semi-Direct
 Spacing Criteria: 3.1

ZONAL LUMEN SUMMARY

ZONE	LUMENS	%LAMP	%FIXT.
0-30	410	4.3	5.1
0-40	852	9.0	10.7
0-60	1967	20.7	24.6
0-90	5021	52.9	62.9
90-120	2845	29.9	35.6
90-130	2948	31.0	36.9
90-150	2965	31.2	37.1
90-180	2967	31.2	37.1
0-180	7988	84.1	100.0

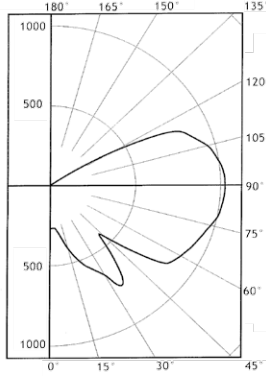

REPORT NUMBER: **KPB100LG3**

Lamps: 100 W High Pressure Sodium C100S54 ED23 – 1/2 Mogul Base with G3 Globe only

COEFFICIENTS OF UTILIZATION – ZONAL CAVITY METHOD
 EFFECTIVE FLOOR CAVITY REFLECTANCE 0.20

RC	80				70				50				30				10				0
	RW	70	50	30	10	70	50	30	10	50	30	10	50	30	10	50	30	10			
0	93	93	93	93	87	87	87	87	76	76	76	66	66	66	57	57	57	57	53		
1	79	72	67	62	73	67	62	58	58	54	50	49	46	43	41	39	36	32	32		
2	69	60	52	46	64	56	49	43	48	42	37	40	36	32	33	30	26	23	23		
3	62	51	43	36	57	47	40	34	40	34	29	34	29	24	28	24	20	17	17		
4	56	44	36	29	51	41	33	27	35	28	23	29	24	20	24	19	16	13	13		
5	51	39	30	24	47	36	28	22	30	24	19	25	20	16	21	17	13	10	10		
6	47	34	26	20	43	32	24	19	27	21	16	23	17	13	19	14	11	8	8		
7	43	31	23	17	40	28	21	16	24	18	14	20	15	13	17	13	9	7	7		
8	40	28	20	15	37	26	19	14	22	16	12	19	14	10	15	11	8	6	6		
9	37	25	18	13	34	23	17	12	20	14	10	17	12	9	14	10	7	5	5		
10	34	23	16	11	32	21	15	11	18	13	9	16	11	8	13	9	6	5	5		

Appleton®

HID/AREA: NEC/CEC ENCLOSED AND GASKETED

Degree	Candela	Lumens
0	1466	
5	1473	142
15	1607	456
25	1675	775
35	1757	1071
45	1316	1047
55	1502	1316
65	1377	1362
75	465	589
85	92	111
90	16	
95	3	5
105	6	6
115	40	33
125	5	8
135	3	2
145	3	1
155	2	1
165	0	1
175	1	0
180	1	

TOTAL LUMINAIRE EFFICIENCY = 72.9%

CIE Type – Direct
 Spacing Criteria: 1.6

ZONAL LUMEN SUMMARY

ZONE	LUMENS	%LAMP	%FIXT.
0-30	1373	14.5	19.8
0-40	2445	25.7	35.3
0-60	4807	50.6	69.4
0-90	6869	72.3	99.2
90-120	45	0.5	0.6
90-130	53	0.6	0.8
90-150	56	0.6	0.8
90-180	58	0.6	0.8
0-180	6927	72.9	100.0

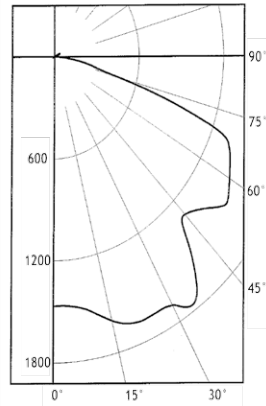

REPORT NUMBER: **KPB100LG3 ST**

Lamps: 100 W High Pressure Sodium C100S54 ED23 – 1/2 Mogul Base with G3 Globe and Standard Dome Reflector

COEFFICIENTS OF UTILIZATION – ZONAL CAVITY METHOD
 EFFECTIVE FLOOR CAVITY REFLECTANCE 0.20

RC	80				70				50				30				10				0
	RW	70	50	30	10	70	50	30	10	50	30	10	50	30	10	50	30	10			
0	87	87	87	87	85	85	85	85	81	81	81	77	77	77	74	74	74	72	72		
1	78	74	71	68	76	73	70	67	70	67	65	67	64	62	64	62	60	59	59		
2	70	64	58	53	68	62	57	53	59	55	51	57	53	50	54	52	49	47	47		
3	63	55	48	43	61	54	47	43	51	46	42	49	45	41	47	43	40	38	38		
4	57	48	41	35	55	47	40	35	45	39	34	43	38	34	41	37	33	32	32		
5	52	42	35	30	51	41	34	29	39	34	29	38	33	29	36	32	28	26	26		
6	48	37	30	25	46	37	30	25	35	29	25	34	29	25	33	28	24	23	23		
7	44	34	27	22	43	33	26	22	32	26	22	31	25	21	29	25	21	20	20		
8	41	30	24	19	40	30	24	19	29	23	19	28	23	19	27	22	19	17	17		
9	38	23	21	17	37	27	21	17	26	21	17	25	20	17	25	20	17	15	15		
10	36	25	19	15	35	25	19	15	24	19	15	23	19	15	23	18	15	14	14		

Candela Distribution

	0.0	45.0	90.0	135.0	180.0	Flux
0	1270	1270	1270	1270	1270	
5	1317	1302	1271	1227	1211	122
15	1554	1471	1384	1341	1298	398
25	1779	1680	1528	1353	1246	694
35	1923	1830	1593	1256	1020	917
45	1715	1564	1163	599	361	848
55	1981	1862	1100	287	122	953
65	1923	1751	869	104	0	869
75	1879	1272	298	9	0	711
85	1371	828	140	1	0	424
90	680	422	89	2	1	
95	416	259	47	4	4	144
105	191	93	4	7	6	59
115	40	18	51	54	92	31
125	1	3	3	3	1	2
135	1	2	3	2	1	1
145	0	1	2	0	0	1
155	0	1	2	1	0	1
165	0	1	1	1	0	0
175	2	2	2	1	0	0
180	2	2	2	2	2	

TOTAL LUMINAIRE EFFICIENCY = 65.0%

CIE Type – Direct
 Spacing Criteria: 1.9
 0° 1.9
 90° 1.7
 180° 1.3

ZONAL LUMEN SUMMARY

ZONE	LUMENS	%LAMP	%FIXT.
0-30	1213	12.8	19.7
0-40	2131	22.4	34.5
0-60	3932	41.4	63.7
0-90	5936	62.5	96.1
90-120	234	2.5	3.8
90-130	236	2.5	3.8
90-150	238	2.5	3.9
90-180	239	2.5	3.9
0-180	6175	65.0	100.0

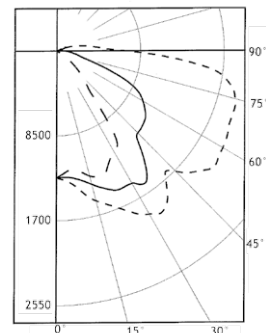

LEGEND
 0-deg - - - - -
 90-deg - - - - -
 180-deg - - - - -

REPORT NUMBER: **KPB100LG3 AN**

Lamps: 100 W High Pressure Sodium C100S54 ED23 – 1/2 Mogul Base with G3 Globe and 30° Angle Reflector

COEFFICIENTS OF UTILIZATION – ZONAL CAVITY METHOD
 EFFECTIVE FLOOR CAVITY REFLECTANCE 0.20

RC	80				70				50				30				10				0
	RW	70	50	30	10	70	50	30	10	50	30	10	50	30	10	50	30	10			
0	77	77	77	77	75	75	75	75	71	71	71	67	67	67	64	64	64	62	62		
1	68	64	61	57	66	62	59	56	59	56	54	56	54	52	53	51	50	48	48		
2	61	55	49	45	59	53	48	44	50	46	43	48	44	41	45	42	40	38	38		
3	55	47	41	36	53	46	40	36	44	39	35	41	37	34	39	36	33	31	31		
4	50	41	35	30	48	40	34	30	38	33	29	36	32	28	35	31	28	26	26		
5	46	37	30	25	44	36	30	25	34	29	25	32	28	24	31	27	24	22	22		
6	42	33	26	22	41	32	26	22	30	25	21	29	24	21	28	24	20	19	19		
7	39	30	23	19	38	29	23	19	28	22	19	26	22	18	25	21	18	17	17		
8	36	27	21	17	35	26	21	17	25	20	16	24	20	16	23	19	16	15	15		
9	34	25	19	15	33	24	19	15	23	18	15	22	18	14	21	17	14	13	13		
10	32	23	17	14	31	22	17	13	21	17	13	20	16	13	20	16	13	12	12		

Mercmaster™ III HID 50–250 Watt Luminaires

150 W HPS

* Photometric data is based on fixtures with a 150-watt clear High Pressure Sodium lamp (16,000 lumen). For candlepower values of fixtures with other HPS lamps, use the following multipliers: for a 70 W (6,400 lumen) HPS lamp – 0.40; for a 50 W (4,000 lumen) HPS lamp – 0.25. For candlepower values of fixture with guard, multiply by 0.95.

NEC/CEC:

Class I, Division 2, Groups A, B, C, D
Class I, Zone 2, AEx nA nR IIC (Z2)
Class I, Zone 2, AEx nR IIC (ZB)
Class II, Division 1 and 2, Groups E, F, G
Class III

NEC/CEC:

Simultaneous Exposure (Class I, Division 2/
Class II, Division 1)
Fixtures Outside Type (Salt Water)
Type 4X
IP66

Photometric Data

Degree	Candela	Lumens
0	488	
5	459	46
15	703	202
25	938	442
35	1107	672
45	892	710
55	1420	1253
65	1542	1529
75	1629	1723
85	1675	1824
90	1665	
95	1643	1788
105	1515	1599
115	1072	1042
125	51	115
135	20	16
145	19	12
155	6	4
165	1	0
175	0	0
180	2	

TOTAL LUMINAIRE EFFICIENCY = 81.1%

CIE Type – Semi-Direct

Spacing Criteria: 3.0

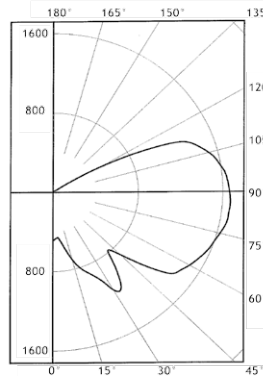

ZONAL LUMEN SUMMARY

ZONE	LUMENS	%LAMP	%FIXT.
0-30	689	4.3	5.3
0-40	1361	8.5	10.5
0-60	3324	20.8	25.6
0-90	8400	52.5	64.7
90-120	4429	27.7	34.1
90-130	4544	28.4	35.0
90-150	4572	28.6	35.2
90-180	4576	28.6	35.3
0-180	12976	81.1	100.0

REPORT NUMBER: KPB150LG3

Lamps: 150 W High Pressure Sodium C100S54 ED23 – 1/2 Mogul Base with G3 Globe only

COEFFICIENTS OF UTILIZATION – ZONAL CAVITY METHOD

		EFFECTIVE FLOOR CAVITY REFLECTANCE 0.20																
RC	RW	80			70			50			30			10			0	
		70	50	30	10	70	50	30	10	50	30	10	50	30	10			
0	90	90	90	90	84	84	84	84	74	74	74	65	65	65	56	56	56	53
1	76	70	65	60	71	65	60	56	56	53	49	48	45	42	41	38	36	32
2	67	58	51	44	62	54	47	42	46	41	36	39	35	31	33	29	26	23
3	60	49	41	34	55	46	38	32	39	33	28	33	28	24	27	23	20	17
4	54	43	34	29	50	40	32	26	34	27	22	28	23	19	23	19	16	13
5	49	37	29	23	45	35	27	21	30	23	18	25	20	16	21	16	13	10
6	45	33	25	19	42	31	23	18	26	20	15	22	17	13	18	14	11	8
7	41	30	22	16	38	27	20	15	24	18	13	20	15	11	16	12	9	7
8	38	27	19	14	35	25	18	13	21	16	11	18	13	10	15	11	8	6
9	36	24	17	12	33	23	16	12	19	14	10	17	12	8	14	10	7	5
10	33	22	15	11	31	21	14	10	18	12	9	15	11	7	13	9	6	4

Degree	Candela	Lumens
0	2403	
5	2391	230
15	2624	744
25	2678	1247
35	2705	1673
45	2250	1754
55	2444	2161
65	2246	2192
75	655	851
85	147	174
90	26	
95	6	8
105	11	13
115	73	71
125	7	12
135	6	3
145	4	2
155	4	2
165	2	1
175	2	0
180	1	

TOTAL LUMINAIRE EFFICIENCY = 69.6%

CIE Type – Direct

Spacing Criteria: 1.6

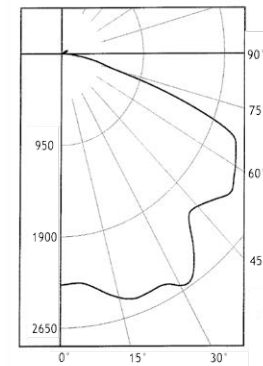

ZONAL LUMEN SUMMARY

ZONE	LUMENS	%LAMP	%FIXT.
0-30	2221	13.9	19.9
0-40	3895	24.3	35.0
0-60	7809	48.8	70.1
0-90	11027	68.9	99.0
90-120	92	0.6	0.8
90-130	104	0.6	0.9
90-150	109	0.7	1.0
90-180	112	0.7	1.0
0-180	11139	69.6	100.0

REPORT NUMBER: KPB150LG3_ST

Lamps: 150 W High Pressure Sodium C100S54 ED23 – 1/2 Mogul Base with G3 Globe and Standard Dome Reflector

COEFFICIENTS OF UTILIZATION – ZONAL CAVITY METHOD

		EFFECTIVE FLOOR CAVITY REFLECTANCE 0.20																
RC	RW	80			70			50			30			10			0	
		70	50	30	10	70	50	30	10	50	30	10	50	30	10			
0	83	83	83	83	81	81	81	81	77	77	77	74	74	74	70	70	70	69
1	75	71	68	65	73	70	67	64	66	64	62	64	62	60	61	59	58	56
2	67	61	56	51	65	60	55	51	57	53	49	54	51	48	52	49	47	45
3	61	52	46	41	59	51	46	41	49	44	40	47	43	39	45	41	38	37
4	55	46	39	34	53	45	38	34	43	37	33	41	36	33	39	35	32	30
5	50	40	33	28	48	39	33	28	38	32	28	36	31	27	35	31	27	25
6	46	36	29	24	44	35	29	24	34	28	24	32	27	24	31	27	23	22
7	42	32	26	21	41	32	25	21	30	25	21	29	24	20	28	24	20	19
8	39	29	23	18	38	29	23	18	28	22	18	27	22	18	26	22	18	16
9	36	27	20	16	35	26	20	16	25	20	16	24	20	16	24	19	16	15
10	34	24	19	15	33	24	18	15	23	18	14	22	18	14	22	17	14	13

Candela Distribution

	0.0	45.0	90.0	135.0	180.0	Flux
0	1964	1964	1964	1964	1964	
5	2035	2007	1941	1871	1838	187
15	2375	2307	2140	2047	2037	619
25	2755	2587	2288	2095	1853	1081
35	2924	2763	2415	1885	1276	1416
45	2790	2552	2015	780	518	1368
55	3166	2937	1945	410	157	1520
65	3188	2913	777	77	0	1380
75	3145	2547	408	1	2	1118
85	2533	927	117	0	2	663
90	1490	640	14	5	9	
95	765	449	5	8	11	239
105	380	163	6	11	15	106
115	114	4	6	18	63	44
125	2	5	7	8	7	5
135	2	6	7	8	6	4
145	0	2	6	4	2	3
155	2	4	6	4	2	3
165	4	3	5	4	2	1
175	0	2	3	3	2	0
180	2	2	2	2	2	

TOTAL LUMINAIRE EFFICIENCY = 61.0%

CIE Type – Direct

Spacing Criteria

Plane	Spacing Criteria
0°	2.0
90°	1.7
180°	1.3

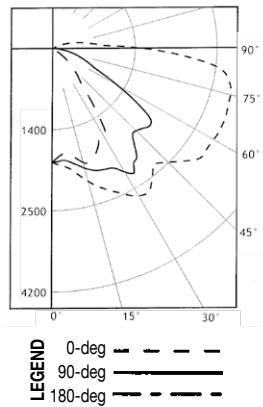

ZONAL LUMEN SUMMARY

ZONE	LUMENS	%LAMP	%FIXT.
0-30	1886	11.8	19.3
0-40	3302	20.6	33.8
0-60	6190	38.7	63.5
0-90	9351	58.4	95.9
90-120	389	2.4	4.0
90-130	395	2.5	4.0
90-150	401	2.5	4.1
90-180	404	2.5	4.1
0-180	9754	61.0	100.0

REPORT NUMBER: KPB150LG3_AN

Lamps: 150 W High Pressure Sodium C100S54 ED23 – 1/2 Mogul Base with G3 Globe and 30° Angle Reflector

COEFFICIENTS OF UTILIZATION – ZONAL CAVITY METHOD

		EFFECTIVE FLOOR CAVITY REFLECTANCE 0.20																
RC	RW	80			70			50			30			10			0	
		70	50	30	10	70	50	30	10	50	30	10	50	30	10			
0	72	72	72	72	70	70	70	70	66	66	66	63	63	63	60	60	60	58
1	64	60	57	54	62	58	55	53	55	53	50	52	50	48	50	48	47	45
2	57	51	46	42	55	50	45	41	47	43	40	45	41	39	42	40	37	36
3	52	44	38	34	50	43	38	33	41	36	33	39	35	32	37	33	31	29
4	47	39	33	28	45	38	32	28	36	31	27	34	30	26	32	29	26	24
5	43	34	28	24	41	33	28	24	32	27	23	30	26	22	29	25	22	21
6	39	31	25	20	38	30	24	20	28	24	20	27	23	19	26	22	19	18
7	36	28	22	18	35	27	22	18	26	21	17	25	20	17	24	20	17	15
8	34	25	20	16	33	24	19	16	23	19	15	22	18	15	22	18	15	14
9	32	23	18	14	30	22	17	14	21	17	14	21	16	13	20	16	13	12
10	30	21	16	13	29	21	16	12	20	15	12	19	15	12	18	15	12	11

Mercmaster™ III HID 50–250 Watt Luminaires

250 W PSMH

* Photometric data is based on fixtures with a 250-watt clear Pulse Start Metal Halide lamp (23,000 lumen). For candlepower values of fixtures with other PSMH lamps, (21,000 lumen) PSMH lamp – 0.913. For candlepower values of fixture with guard, multiply by 0.95.

NEC/CEC:
 Class I, Division 2, Groups A, B, C, D
 Class I, Zone 2, AEx nA nR IIC (Z2)
 Class I, Zone 2, AEx nR IIC (ZB)
 Class II, Division 1 and 2, Groups E, F, G
 Class III

NEC/CEC:
 Simultaneous Exposure (Class I, Division 2)
 Class II, Division 1)
 Fixtures Outside Type (Salt Water)
 Type 4X
 IP66

Photometric Data

Zone	Lumens	TOTAL LUMINAIRE EFFICIENCY = 67.4%
0-10	307.05	CIE Type – Direct
10-20	986.27	Spacing Criteria: 2.16
20-30	1556.63	
30-40	2215.28	
40-50	2539.71	
50-60	2525.66	
60-70	2313.2	
70-80	1992.57	
80-90	1470.76	
90-100	689.06	
100-110	177.72	
110-120	46	
120-130	10.39	
130-140	6.24	
140-150	5.71	
150-160	3.95	
160-170	2.26	
170-180	.8	

ZONAL LUMEN SUMMARY			
ZONE	LUMENS	%LAMP	%FIXT.
0-30	2849.95	11.4	16.9
0-40	5065.22	20.3	30.1
0-60	10130.59	40.5	60.1
0-90	15907	63.6	94.4
90-120	912.78	3.7	5.4
90-130	923.17	3.7	5.5
90-150	935.11	3.7	5.5
90-180	942.12	3.8	5.6
0-180	16849.24	67.4	100.0

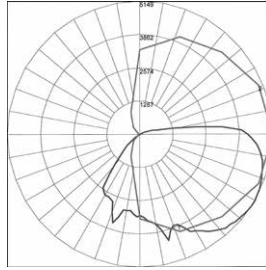

REPORT NUMBER: **KPBG250PAN**
 Lamps: 250 W Metal Halide Pulse Start
 Mogul Base

COEFFICIENTS OF UTILIZATION – ZONAL CAVITY METHOD
 EFFECTIVE FLOOR CAVITY REFLECTANCE 0.20

RC	80				70				50				30				10				0
	RW	70	50	30	10	70	50	30	10	50	30	10	50	30	10	50	30	10	0		
0	79	79	79	79	77	77	77	77	73	73	73	69	69	69	65	65	65	65	64		
1	70	65	62	58	67	63	60	57	60	57	54	56	54	52	53	51	50	48	48		
2	62	55	50	45	60	54	49	44	51	46	43	48	44	41	45	42	39	38	38		
3	56	48	41	36	54	46	40	36	44	39	34	41	37	33	39	35	32	30	30		
4	51	42	35	30	49	41	34	29	38	33	29	36	31	28	34	30	27	25	25		
5	47	37	30	25	45	36	30	25	34	28	24	32	27	23	30	26	23	21	21		
6	43	33	26	21	41	32	26	21	30	25	21	29	24	20	27	23	20	18	18		
7	40	30	23	19	38	29	23	18	27	22	18	26	21	18	25	20	17	16	16		
8	37	27	21	16	35	26	20	16	25	20	16	24	19	16	23	18	15	14	14		
9	34	24	19	15	33	24	18	14	23	18	14	22	17	14	21	17	14	12	12		
10	32	22	17	13	31	22	17	13	21	16	13	20	16	12	19	15	12	11	11		

Zone	Lumens	TOTAL LUMINAIRE EFFICIENCY = 72.6%
0-10	382.83	CIE Type – Direct
10-20	1200.76	Spacing Criteria: 1.58
20-30	1987.77	
30-40	2662.58	
40-50	3136.15	
50-60	3436.26	
60-70	3412.32	
70-80	1660.08	
80-90	278.17	
90-100	3.43	
100-110	0	
110-120	0	
120-130	0	
130-140	0	
140-150	0	
150-160	0	
160-170	0	
170-180	0	

ZONAL LUMEN SUMMARY			
ZONE	LUMENS	%LAMP	%FIXT.
0-30	3571.36	14.3	19.7
0-40	6233.94	24.9	34.3
0-60	12806.35	51.2	70.5
0-90	18156.91	72.6	100
90-120	3.43	0	0
90-130	3.43	0	0
90-150	3.43	0	0
90-180	3.43	0	0
0-180	18160.34	72.6	100.0

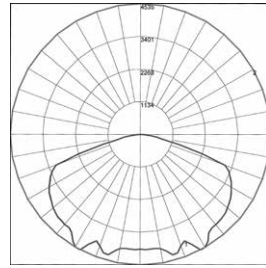

REPORT NUMBER: **KPBG250PST**
 Lamps: 250 W Metal Halide Pulse Start
 Mogul Base

COEFFICIENTS OF UTILIZATION – ZONAL CAVITY METHOD
 EFFECTIVE FLOOR CAVITY REFLECTANCE 0.20

RC	80				70				50				30				10				0
	RW	70	50	30	10	70	50	30	10	50	30	10	50	30	10	50	30	10	0		
0	86	86	86	86	84	84	84	84	81	81	81	77	77	77	74	74	74	73	73		
1	78	74	71	68	76	73	70	67	70	67	65	67	65	63	64	62	61	59	59		
2	70	63	58	53	68	62	57	53	59	55	51	57	53	50	55	52	49	47	47		
3	63	55	48	43	61	53	47	42	51	46	42	49	45	41	47	43	40	38	38		
4	57	48	41	35	55	47	40	35	45	39	34	43	38	34	41	37	33	32	32		
5	52	42	35	30	50	41	34	29	39	34	29	38	33	29	37	32	28	27	27		
6	48	37	30	25	46	37	30	25	35	29	25	34	29	25	33	28	24	23	23		
7	44	33	27	22	43	33	26	22	32	26	22	31	25	21	30	25	21	20	20		
8	41	30	24	19	40	30	23	19	29	23	19	28	23	19	27	22	19	17	17		
9	38	28	21	17	37	27	21	17	26	21	17	25	20	17	25	20	17	15	15		
10	35	25	19	15	35	25	19	15	24	19	15	23	18	15	23	18	15	14	14		

Candela Distribution

Zone	Lumens	TOTAL LUMINAIRE EFFICIENCY = 85.5%
0-10	74.54	CIE Type – General Diffuse
10-20	304.58	
20-30	486.47	
30-40	948.61	
40-50	1471.61	
50-60	1887.31	
60-70	2239.17	
70-80	2561.7	
80-90	2747.67	
90-100	2779.02	
100-110	2564.95	
110-120	2148.15	
120-130	1109.49	
130-140	37.55	
140-150	3.93	
150-160	.76	
160-170	.09	
170-180	.03	

ZONAL LUMEN SUMMARY			
ZONE	LUMENS	%LAMP	%FIXT.
0-30	865.59	3.5	4.1
0-40	1814.2	7.3	8.5
0-60	5173.13	20.7	24.2
0-90	12721.67	50.9	59.5
90-120	7492.124	30	35.1
90-130	8601.61	34.4	40.3
90-150	8643.09	34.6	40.5
90-180	8643.97	34.6	40.5
0-180	21365.63	85.5	100.0

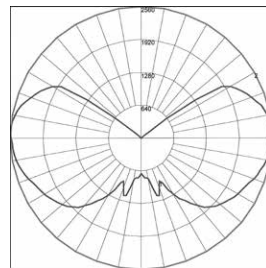

REPORT NUMBER: **KPBG250PG**
 Lamps: 250 W Metal Halide Pulse Start
 Mogul Base

COEFFICIENTS OF UTILIZATION – ZONAL CAVITY METHOD
 EFFECTIVE FLOOR CAVITY REFLECTANCE 0.20

RC	80				70				50				30				10				0
	RW	70	50	30	10	70	50	30	10	50	30	10	50	30	10	50	30	10	0		
0	94	94	94	94	87	87	87	87	76	76	76	65	65	65	55	55	55	55	51		
1	80	74	68	63	74	68	63	59	58	54	51	49	46	43	40	38	36	31	31		
2	71	61	54	47	65	57	50	44	48	42	38	40	36	32	32	29	26	22	22		
3	63	52	44	37	58	48	41	34	41	34	29	33	29	25	27	23	20	16	16		
4	57	45	36	30	52	42	34	28	35	29	24	29	24	20	23	19	16	13	13		
5	52	40	31	25	47	36	29	23	31	24	19	25	20	16	20	16	13	10	10		
6	47	35	27	21	43	32	25	19	27	21	16	22	17	13	18	14	11	8	8		
7	44	31	23	18	40	29	22	16	24	18	14	20	15	11	16	12	9	7	7		
8	40	28	20	15	37	26	19	14	22	16	12	18	13	10	15	11	8	6	6		
9	37	25	18	13	34	24	17	12	20	14	10	17	12	9	13	10	7	5	5		
10	35	23	16	12	32	22	15	11	18	13	9	15	11	8	12	9	6	4	4		

Mercmaster™ III HID 50–250 Watt Luminaires

High Pressure Sodium, Pulse Start Metal Halide and Metal Halide

Listed for simultaneous exposure to combustible dusts and flammable gases or vapors.

CEC:

Class I, Division 2, Groups A, B, C, D
Class I, Zone 2 Ex nR IIC (Z)
Class II, Division 1 and 2, Groups E, F, G
Class III

CEC:

Type 4X
IP66

Applications

- Enclosed and gasketed fixtures suitable for use in:
 - Marine and wet locations
 - A wide range of industrial, chemical processing and other areas where flammable gases and vapors or combustible dusts are present under conditions defined by the National Electrical Code as Class I, Division 2; Class II, Division 1 and 2; and Class III
 - For Zone 2, the method of protection is Ex nR – Restricted Breathing/Nonsparking.
 - Non-hazardous locations where severe weather conditions, excessive moisture, dirt, dust, corrosive atmosphere or high ambient temperatures are encountered. 18% cooler operation allows use in ambient temperatures up to 65 °C (149 °F) depending on fixture component combinations
- Typical applications include:
 - Pulp and paper mills
 - Processing plants
 - Chemical plants
 - Oil refineries
 - Foundries
 - Manufacturing plants
 - Storage areas
 - Marine applications
- Fixtures have NEMA 4X listing.
- Suitability includes listing for use where there may be simultaneous exposure to combustible dusts and flammable gases and vapors. See listing pages for compliance data on specific fixture component combinations.

Features

- Modular design allows scores of fixture component combinations to meet installation and lighting needs. Many most-used combinations are offered prewired and assembled, complete with lamp, packaged in a single carton and ready to install.
- Mogul lamp types and wattages:
 - HPS 50W-150W
 - PSMH 70W-250W ②
- Choice of heat-resistant prismatic glass refractors (NEMA distributions I, III and V), or heat-resistant prismatic glass globes for hazardous area fixtures. Colored and clear polycarbonate globes and Tuff-skin® ① coated glass globes are available but are NOT approved for use in classified areas. Fixtures with these globes do NOT comply with code requirements, and should be used in non-classified areas only. Globes and refractors thread directly into ballast housing.
- Mounting hoods include cone-shaped pendant hood, standard pendant, flexible pendant, ceiling and wall pendants (tapped for 3/4" or 1" NPT), 25° angle stanchion, and 90° (straight) stanchion (both tapped for 1-1/4" or 1-1/2" NPT).
- Cone hood fixtures for pendant mounting shed dust, dirt and combustible fibers. Cone hood inhibits build-up that "insulates" fixture and slows heat transfer, and provides increased surface area for more effective heat dissipation.



Pendant Mount Fixture
with Prismatic Glass Refractor



Straight Stanchion-Mount Fixture
with Prismatic Glass Refractor and
Guard



Pendant Cone Fixture with
Prismatic Glass Globe and Guard



Ceiling Mount Fixture
with Prismatic Glass Globe, Guard
and Polyester 30° Angle Reflector

- Reflector choice includes standard dome and 30° angle types, both made of Fiberglass reinforced white polyester. Highly resistant to unusually corrosive applications. Reflectors are vented for cooler, dirt-free operation and maintained lumen output. They secure to ballast housing with stainless steel screws threading into stainless steel inserts.
- For high corrosion resistance, fixture housing, mounting hoods and guards are copperfree cast aluminum with baked epoxy finish, electrostatically applied for uniformity. All exposed hardware is stainless steel.
- Hinge has high lip for added safety during installation and servicing. Hinge and bolt construction assures 360° compression at all points on ballast housing gasket for positive sealing. Swing-away design of captive bolt and nut simplifies servicing.
- Body gaskets and globe gaskets are high-temperature silicone rubber.
- Capacitors are non-PCB type, thermally isolated from ballast.

① Tuff-skin is a registered trademark of Thomas Manufacturing Corp., Parkton, Maryland.

② Mercury vapor and metal halide luminaires are not available for purchase within the United States. Please check with your countries governing legislation regarding allowable lamp types before ordering.

Mercmaster™ III HID 50–250 Watt Luminaires

High Pressure Sodium, Pulse Start Metal Halide and Metal Halide

Listed for simultaneous exposure to combustible dusts and flammable gases or vapors.

CEC:

Class I, Division 2, Groups A, B, C, D
Class I, Zone 2 Ex nR IIC (Z)
Class II, Division 1 and 2, Groups E, F, G
Class III

CEC:

Type 4X
IP66

- Mogul base porcelain socket with nickel-plated contacts has 200 °C (392 °F) welded leads, prewired to the ballast. Assures trouble-free operation in installations where high ambient temperatures are encountered.
- HPS ballasts are High Power Factor (min. P.F. 90%).
- A wide range of voltages available (120 to 600 Volt) and ballast types (Reactor, CWA, CWI and Super CWA).
- All Mercmaster III mounting hoods have provision for easy field installation of fuses in fixtures (see fuse kit listings in this catalog section).
- For electrical protection, a ground wire is provided on each Mercmaster to bond hood and ballast housing.
- The Ex nR factory sealed Mercmaster III prevents vapors and gases from entering the globe chamber. There are no seals or putty required which will reduce installation time and installation errors.

Standard Materials

- Mounting hoods, ballast bodies and guards: copperfree cast aluminum (less than 4/10 of 1%)
- Exposed hardware: stainless steel; latch assemblies have stainless steel bolt and captive nut; reflectors and guards attach with stainless steel screws threading into stainless steel inserts.
- Reflectors: Fiberglass reinforced white polyester
- Globes: heat-resistant prismatic glass
- Refractors: heat-resistant prismatic glass

Standard Finishes

- Mounting hoods, ballast bodies, guards: epoxy powder coat finish, electrostatically applied for complete, uniform surface protection
- Reflectors: white polyester finish

Options

- Ex nR fixtures, add suffix **-Z**.
- Fuses can be field-installed on Mercmaster III fixtures. Kits include fuse block, wire connectors and screws for attaching to mounting hood. For fuse kits, see *Fuse Kits* page.
- Hot Restrike will restrike HPS lamp immediately when power is restored after a momentary power interruption. Add suffix **-R**.
- Smart Starter incorporates a 1-1/2-minute timer and performs as a conventional starter to normally start lamp. Removes itself from circuit if lamp burns out or is removed from socket. Eliminates starter failures caused by prolonged operation with cycling or failing lamps and simplifies finding their location, reducing maintenance and repair costs. Available for all HPS and PSMH fixtures. Add suffix **-S**.
- Optional photocell for all fixtures except cone and ceiling mount provides automatic “on-off” control.
- Quartz Auxiliary comes to full brightness immediately and remains lit until the HID lamp attains 60-70% of full illumination. Quartz Auxiliary supplied with relay switch and socket to accept 120 V quartz double contact bayonet base lamp (not included). Add suffix **-E** to fixture catalog number. ①

CEC Certifications and Compliances

- CSA Certified: 025428
- CSA Standard: CSA C22.2 No. 9, C22.2 No. 137; CAN/CSA E60079-0, E60079-15
- PSMH 250W MT (120/208/240/277, 60 Hz) Fixtures are not UL Listed

Related Products

- Classified area photo controls are also available.

① Fixtures equipped with a quartz auxiliary lamp do not comply with UL requirements and are not suitable for use in classified locations.

Mercmaster™ III HID 50–250 Watt Luminaires

High Pressure Sodium, Pulse Start Metal Halide and Metal Halide

Listed for simultaneous exposure to combustible dusts and flammable gases or vapors.

CEC:

Class I, Division 2, Groups A, B, C, D
Class I, Zone 2 Ex nR IIC (Z)
Class II, Division 1 and 2, Groups E, F, G
Class III

CEC:

Type 4X
IP66

Illustrated Features



High Temperature Sockets

Mogul base high-temperature porcelain sockets.

Aluminum Inner Reflector

Solid aluminum inner reflector (for refractor ballast housings only) improves photometric efficiency.

Globe Chamber (Zone 2)

Completely sealed from the ballast housing and outside vapors/air (nA nR).



Vented Reflectors

Reflectors are thick, tough fiberglass-reinforced white polyester, vented for cooler operation. Quickly attach with furnished stainless steel screws.

Terminal Blocks (Zone 2)

A seven-point terminal block is provided to facilitate wiring. Terminal block accommodates wire size ranging from #8 to #24 AWG.

Stainless Steel Inserts

Ballast bodies have stainless steel threaded inserts to receive stainless steel screws for reflectors and guard. Prevents "freezing", allowing guards and reflectors to be easily removed and replaced at any time, without damage to the housing.



Ballast Assembly (Zone 2)

Utilizing non-sparking components avoiding the ignition of gases or vapors that may be present (nA).

Mounting Hood and Globe Gaskets

Silicone rubber gasket seals out moisture, dirt and dust. Stays flexible, withstands high temperatures. Closure design assures uniform gasket compression.

Electrical Protection

Ground wire provided to bond mounting hood to ballast housing.



"Safety" High Hinge

Extra-high hinge provides additional protection against accidental ballast housing disengagement during installation or maintenance.



Stainless Steel Latch Assembly

Captive, stainless steel latch assembly bolt and nut closes securely, resists attack of corrosive atmospheres. Swing-away design simplifies servicing.

Epoxy Finish

Ballast housing, hoods and guards are copperfree aluminum with epoxy powder coat finish.

Photocell

Available for all fixtures except cone and ceiling mount. Installs through knock-out in mounting hood. Provides continuous ON-OFF dusk-to-dawn control.

Heat-Resistant Globes and Refractors

Prismatic glass globes and refractors are heat-resistant. They thread directly into the ballast housing and seal against a high-temperature silicone rubber gasket.



Cooler Operating Cone Hood

Larger sloped surface sheds dusts, dirt and combustible fibers providing better heat dissipation.



Fuses

Two screws secure fuse kit to mounting boss in any Mercmaster mounting hood. Fuse included.

Mercmaster™ III HID 50–250 Watt Luminaires

High Pressure Sodium, Pulse Start Metal Halide and Metal Halide

Listed for simultaneous exposure to combustible dusts and flammable gases or vapors.

CEC:
 Class I, Division 2, Groups A, B, C, D
 Class I, Zone 2 Ex nR IIC (Z)
 Class II, Division 1 and 2, Groups E, F, G
 Class III

CEC:
 Type 4X
 IP66

Quartz Emergency Light for Pulse Start Metal Halide or High Pressure Sodium Fixtures ①

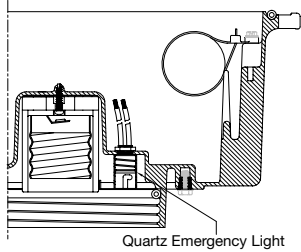

Quartz Emergency Light for PSMH or HPS Fixtures

Mercmaster fixtures for metal halide and high pressure sodium lamps can be supplied with a socket to accept a 150 W or 250 W, 120 V quartz lamp. This D.C. bayonet base socket is in addition to the standard lamp socket. In the event of a momentary power interruption, the quartz lamp is automatically switched on. The single ended quartz lamp remains energized until the HID restrikes and reaches about 60% output.

The quartz emergency lamp socket is wired to a 120 V tap on the ballast and is therefore independent of the lighting fixture voltage. No special field wiring is necessary.

Description	Catalog Suffix
For fixture volts of 120, 208, 240 or 277	-MTE

Accessory Options

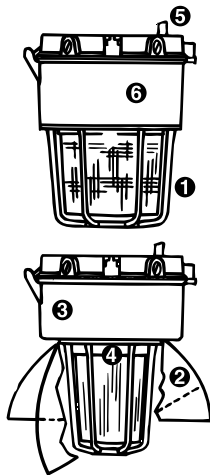

① **Guards:** Guards are die-cast copperfree aluminum with baked epoxy finish to match fixtures. Fixture supplied with stainless steel mounting screws which thread into stainless steel inserts on fixture housing to attach guard. To order fixture with guard, add suffix **-G** to catalog number before adding voltage suffix.

② **Reflectors:** Standard dome and 30° angle polyester reflectors are shown elsewhere in this catalog section.

③ **Hot Restrike:** Instantly restrikes a hot HPS lamp when power is restored after a momentary outage. Available factory-installed only. To order, add suffix **-R** to catalog number.

④ **Quartz Emergency Light:** When ordered, HPS fixtures will be supplied with a prewired special DC bayonet base socket to accept a 150W, 120 V quartz lamp (not furnished) that automatically switches on when a power outage occurs. Fixtures ordered with this quartz emergency lamp feature do NOT comply with requirements for classified areas and should be used only in non-classified locations. To order, add suffix **-E** to catalog number and specify if a relay switch is desired.

⑤ **Photocell and Fuses:** Photocontrols are available.

⑥ **Smart Starter:** Performs as a conventional starter in lamp start-up. Removes itself from circuit at end of lamp life or if lamp is out of socket. Add suffix **-S** to catalog number.

① NOTE: Fixtures equipped with quartz emergency light do not comply with UL requirements and are not suitable for use in classified locations.

Mercmaster™ III HID 50–250 Watt Luminaires

High Pressure Sodium, Pulse Start Metal Halide and Metal Halide

Listed for simultaneous exposure to combustible dusts and flammable gases or vapors.

CEC:
 Class I, Division 2, Groups A, B, C, D
 Class I, Zone 2 Ex nR IIC (Z)
 Class II, Division 1 and 2, Groups E, F, G
 Class III

CEC:
 Type 4X
 IP66

Mercmaster III 50-250 Family Tree

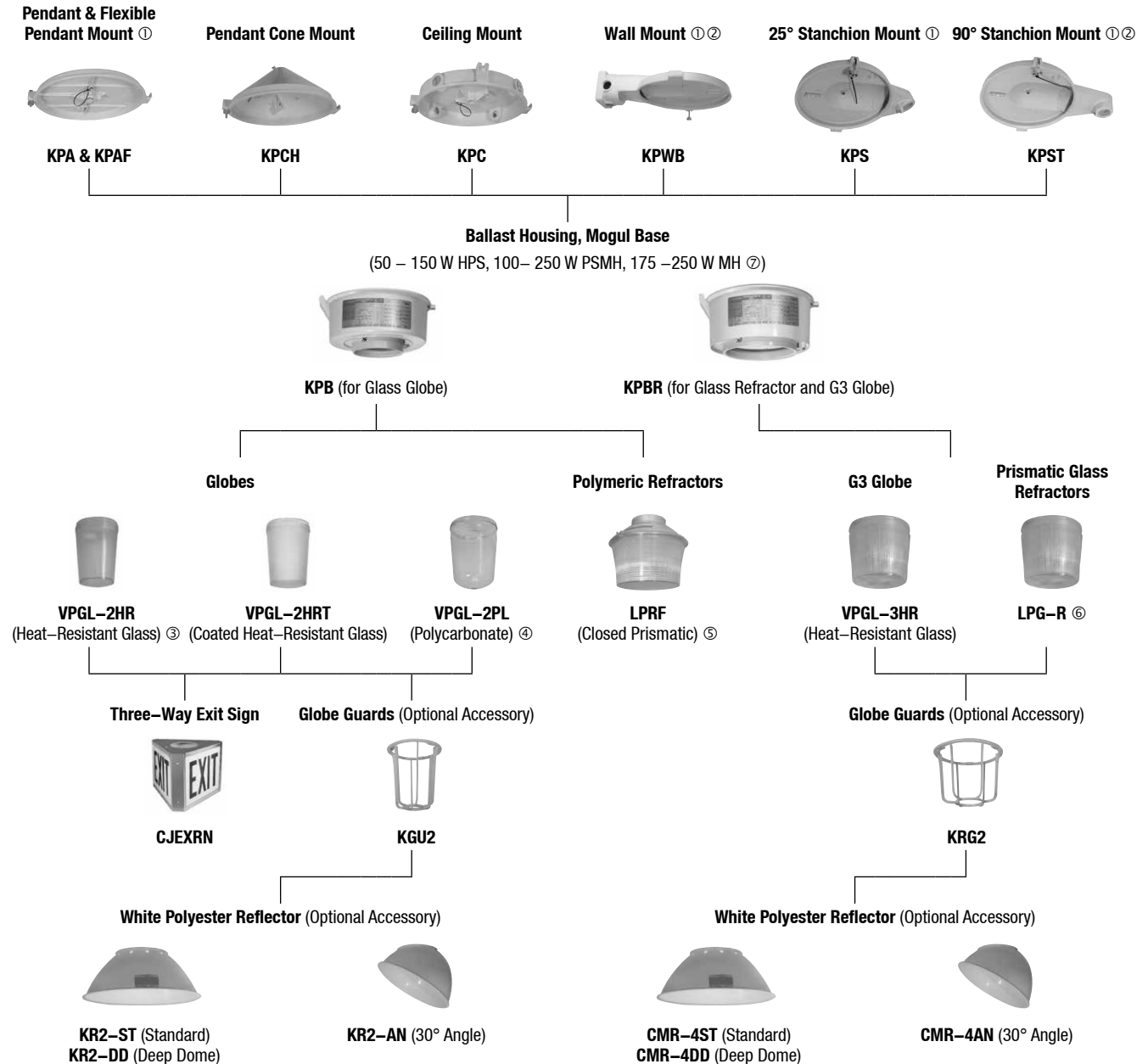

- ① Mounting hood with a 120 V or 208-277 V factory installed photocell is available.
- ② Standard and deep dome reflectors may interfere with bottom conduit entry if used with KPST and KPWB mounting hoods..
- ③ Available in clear, amber, blue, green and red.
- ④ Available in clear, amber, green and red.
- ⑤ Available in NEMA Type II, III, IV and V. Polymeric Refractor suitable for Class II, Groups F and G, NEMA 4X and Marine Type Electric Fixtures Outside Type (Salt Water) only (100 W PSMH Max.).
- ⑥ Available in NEMA Type I, III and V.
- ⑦ Mercury vapor and metal halide luminaires are not available for purchase within the United States. Please check with your countries governing legislation regarding allowable lamp types before ordering.

Mercmaster™ III HID 50–250 Watt Luminaires

High Pressure Sodium, Pulse Start Metal Halide and Metal Halide

Listed for simultaneous exposure to combustible dusts and flammable gases or vapors.

CEC:
 Class I, Division 2, Groups A, B, C, D
 Class I, Zone 2 Ex nR IIC (Z)
 Class II, Division 1 and 2, Groups E, F, G
 Class III

CEC:
 Type 4X
 IP66

Order using catalog numbering guide below or select catalog number from tables on following pages.

Catalog Numbering Guide

<u>KP</u>	<u>A</u>	<u>L</u>	<u>70</u>	<u>10</u>	<u>J5</u>	<u>G</u>	<u>MT</u>	<u>R</u>	<u>ZZ</u>
Series: KP - Mercmaster III 250		Lamp Type: H - Metal Halide (MH) ① L - High Pressure Sodium (HPS) P - Pulse Start Metal Halide (PSMH)		Hub Size: 2 - 3/4" NPT 3 - 1" NPT 4 - 1-1/4" NPT Stanchion 5 - 1-1/2" NPT Stanchion		Guard Options: G - Guard (Not for use on RL Highbay Reflector) N - No Guard		Options: C - Safety Cable Adapted D - E-40 Export Socket E - Emergency Quartz F1 - Single Pole Fuse (Specify Voltage) F2 - Double Pole Fuse (Specify Voltage) PC - Non-Haz. Photocell in hood (specify voltage) PCD2 - Div.2 Haz. Photocell in hood (Specify Voltage) R - Hot Restrike (50-150 W HPS only) S - Smart Starter T - Terminal Blocks V - Anti-Vibration Modifications X - Appledapter ③ Mounting Hood Adapter	
	Mounting:		Wattage:		Optical Assembly:		Voltage: ②		Suffix:
	A - Pendant (rigid mounting) C - Ceiling D - Threaded Dust Cone F - Flexible Pendant R - Right Angled Stanchion (90°) S - Angled Stanchion (25°) W - Wall X - Crouse-Hinds Hood Compatible		10 - 100 W HPS/MH 15 - 150 W HPS/MH 17 - 175 W MH 20 - 200 W PSMH 25 - 250 W MH ④ 50 - 50 W HPS (MT - Voltage Only) 70 - 70 W HPS/MH		J1 - NEMA I Glass Refractor J3 - NEMA III Glass Refractor J5 - NEMA V Glass Refractor G2 - Medium Glass Globe G3 - Large Glass Globe RL - Highbay Reflector/ Lens		C2 - 208 V 60 Hz, CWI C3 - 240 V 60 Hz, CWI C6 - 480 V 60 Hz, CWI C7 - 600 V 60 Hz, CWI MT- 120, 208, 240, 277 V, 60 Hz, CWA TT - 120, 277, 347 V, 60 Hz, CWA XP - 220-240 V, 50 Hz, CWA		Z - Zone 2 suffix (required for Ex nR)

Reflectors are ordered separately – see Accessories page.

① H - Lamp type is for 70W and 100W fixtures only.

P - Lamp type is for 175W, 200W and 250W fixtures only.

② Voltages shown are limited to specific combinations.

③ Appledapter is available for use with the pendant, ceiling and angled stanchion mounting only.

④ Optional fusing is available for use with MT, 5MT and 48 voltage suffixes ONLY.

⑤ PSMH 250 W, MT and TT fixtures are not UL Listed.

⑥ Mercury vapor and metal halide luminaires are not available for purchase within the United States. Please check with your countries governing legislation regarding allowable lamp types before ordering.

Mercmaster™ III HID 50–250 Watt Luminaires

Class I, Division 2; Class II, Division 1; Simultaneous Exposure to Hazardous Conditions of Both Classifications
Temperature Identification Numbers of Mercmaster III fixtures.

CEC:
Class I, Division 2, Groups A, B, C, D
Class I, Zone 2 Ex nR IIC (Z)
Class II, Division 1 and 2, Groups E, F, G
Class III

CEC:
Type 4X
IP66

Mercmaster III fixtures are listed for “Simultaneous Exposure” to combinations of Class I, Division 2 and Class II, Division 1 hazardous conditions.

“T” Numbers for Mercmaster III Fixtures

Watts	Lamp Type	Supply Wire Temp. °C (°F)	Ambient Temp. °C (°F)	Class I, Division 2				Class II, Division 1 Groups E, F and G ①				Simultaneous Exposure Class I, Division 2 / Class II, Division 1			
				Globe	Reflector	G3	8”	Globe	Reflector	G3	8”	Globe	Reflector	G3	8”
50	HPS	90 °C (194 °F)	40 °C (104 °F)	T3C	T3B	—	T3C	T4A	T4	—	T6	T3A	T3	—	T3C
		90 °C (194 °F)	55 °C (131 °F)	T3A	T3A	—	T3A	T4	T3B	—	T5	T3	T3	—	T3A
		90 °C (194 °F)	65 °C (149 °F)	T3A	T3	—	T3A	T3C	T3C	—	T4A	T2D	T2D	—	T3
70	HPS	90 °C (194 °F)	40 °C (104 °F)	T3B	T3A	—	T3C	T4	T3C	—	T6	T3	T3	—	T3A
		90 °C (194 °F)	55 °C (131 °F)	T3A	T3A	—	T3B	T3C	T3C	—	T5	T2D	T2D	—	T3
		90 °C (194 °F)	65 °C (149 °F)	T3	T3A	—	T3A	T3C	T3B	—	T4A	T2C	T2C	—	T3
100	HPS	90 °C (194 °F)	40 °C (104 °F)	T2D	T2D	T3	T3	—	T3A (EF)	T3 (EF)	—	—	—	—	—
		90 °C (194 °F)	40 °C (104 °F)	—	—	—	—	T3B	—	T4A	T4A	T2B	T2B	T2C	T2C
		90 °C (194 °F)	55 °C (131 °F)	T2D	T2D	T3	T3	—	—	T4	T4	—	—	T2B	T2B
		90 °C (194 °F)	65 °C (149 °F)	T2D	T2D	T2D	T2D	—	—	—	—	—	—	—	—
150	HPS	90 °C (194 °F)	40 °C (104 °F)	T2B	T2B	—	T2C	—	—	—	T3C	T2	—	—	T2B
		90 °C (194 °F)	40 °C (104 °F)	—	—	—	—	T3 (EF)	—	—	—	—	—	—	—
		90 °C (194 °F)	55 °C (131 °F)	T2B	T2A	—	T2B	—	—	—	—	—	—	—	—
70	PSMH	90 °C (194 °F)	40 °C (104 °F)	T3A	T3A	—	T3A	—	—	—	T3C	—	—	—	—
		90 °C (194 °F)	55 °C (131 °F)	T3A	T3A	—	T3A	—	—	—	T3C	—	—	—	—
		90 °C (194 °F)	65 °C (149 °F)	T3	T2	—	T3	—	—	—	T3C	—	—	—	—
100	PSMH	90 °C (194 °F)	40 °C (104 °F)	T3	T3	—	T3	—	—	—	T3C	—	—	—	T2B
		90 °C (194 °F)	55 °C (131 °F)	T3	T3	—	T3	—	—	—	T3C	—	—	—	T2A
		90 °C (194 °F)	65 °C (149 °F)	T2D	T2D	—	T2D	—	—	—	T3C	—	—	—	—
150	PSMH	90 °C (194 °F)	40 °C (104 °F)	T2B	T2B	—	T2B	—	—	—	T3C	—	—	—	T2B
		90 °C (194 °F)	55 °C (131 °F)	T2A	T2A	—	T2B	—	—	—	T3C	—	—	—	T2A
		125 °C (257 °F)	65 °C (149 °F)	T2A	T2	—	T2B	—	—	—	T3C	—	—	—	—
		90 °C (194 °F)	40 °C (104 °F)	T2B	T2B	—	T2B	—	—	—	T3C	—	—	—	T2B
175	PSMH	90 °C (194 °F)	55 °C (131 °F)	T2A	T2A	—	T2B	—	—	—	T3C	—	—	—	T2A
		125 °C (257 °F)	65 °C (149 °F)	T2A	T2	—	T2B	—	—	—	—	—	—	—	—
		90 °C (194 °F)	40 °C (104 °F)	T2B	T2B	—	T2B	—	—	—	T3B	—	—	—	—
200	PSMH	90 °C (194 °F)	55 °C (131 °F)	T2B	T2B	—	T2B	—	—	—	—	—	—	—	—
		90 °C (194 °F)	40 °C (104 °F)	T2	T2	—	T2	—	—	—	—	—	—	—	—
250	PSMH	90 °C (194 °F)	40 °C (104 °F)	T2	T2	—	T2	—	—	—	—	—	—	—	—
		90 °C (194 °F)	55 °C (131 °F)	T2	T2	—	T2	—	—	—	—	—	—	—	—
175	MH ②	90 °C (194 °F)	40 °C (104 °F)	T2B	T2B	—	T2B	—	—	—	T3C	—	—	—	—
		90 °C (194 °F)	55 °C (131 °F)	T2A	T2A	—	T2B	—	—	—	T3C	—	—	—	—
250	MH ②	90 °C (194 °F)	40 °C (104 °F)	325	325	—	T2	—	—	—	T3B	—	—	—	—

“T” Numbers Represent the Maximum Lamp Temperature for Class I, Division 2 Locations and Maximum Surface Temperature Under Dust Blanket for Class II, Division 1 Locations.

“T” Number	T1	350	325	T2	T2A	T2B	T2C	T2D	T3	T3A	T3B	T3C	T4	T4A	T5	T6
Temp. Range (°C)	351-450	326-350	301-325	281-300	261-280	231-260	216-230	201-215	181-200	166-180	161-165	136-160	121-135	101-120	86-100	85
Temp. Range (°F)	664-842	619-662	574-617	538-572	502-536	448-500	421-446	394-419	358-392	331-356	322-329	277-320	250-275	214-248	187-212	185

① All Class II T Numbers are E, F, G unless otherwise indicated.

② Mercury vapor and metal halide luminaires are not available for purchase within the United States. Please check with your countries governing legislation regarding allowable lamp types before ordering.

Mercmaster™ III HID 50–250 Watt Luminaires

Class I, Zone 2, Ex nR IIC; IP66; and NEMA 4X

Temperature Identification Numbers of Mercmaster III Fixtures.

CEC:
 Class I, Division 2, Groups A, B, C, D
 Class I, Zone 2 Ex nR IIC (Z)
 Class II, Division 1 and 2, Groups E, F, G
 Class III

CEC:
 Type 4X
 IP66

Operating Temperatures: “T” Numbers for Zone 2 Mercmaster III Fixtures

The “T” number is established by separately determining the maximum temperature of the globe surface and ballast compartment. The hotter of the two is taken to determine the “T” number for the overall fixture.

Lamp		Supply Wire Temp. °C (°F)	Ambient Temp. °C (°F)	Class I, Zone 2 Ex nR IIC			
Watts	Type			Globe	Globe & Reflector	Refractor Only	G3/Refractor & Reflector
50	HPS	90 °C (194 °F)	40 °C (104 °F)	T4	T4	T6	T4
		90 °C (194 °F)	55 °C (131 °F)	T4	T3	T5	T3
		90 °C (194 °F)	65 °C (149 °F)	T3	T3	T4	T3
70	HPS	90 °C (194 °F)	40 °C (104 °F)	T4	T4	T4	T4
		90 °C (194 °F)	55 °C (131 °F)	T4	T4	T4	T3
		90 °C (194 °F)	65 °C (149 °F)	T4	T4	T3	T3
100	HPS	90 °C (194 °F)	40 °C (104 °F)	T4	T4	T4	T4
		90 °C (194 °F)	55 °C (131 °F)	T4	T4	T3	T3
		90 °C (194 °F)	65 °C (149 °F)	T4	T4	T3	T3
150	HPS	90 °C (194 °F)	40 °C (104 °F)	T4	T3	T3	T3
		90 °C (194 °F)	55 °C (131 °F)	T3	T3	T3	T3
		105 °C (221 °F)	65 °C (149 °F)	T3	T3	T3	T3
70	PSMH	90 °C (194 °F)	40 °C (104 °F)	T4	T4	T4	—
		90 °C (194 °F)	55 °C (131 °F)	T3	T3	T3	—
		90 °C (194 °F)	65 °C (149 °F)	T3	T3	T3	—
100	PSMH	90 °C (194 °F)	40 °C (104 °F)	T3	T3	T3	—
		90 °C (194 °F)	55 °C (131 °F)	T3	T3	T3	—
		90 °C (194 °F)	65 °C (149 °F)	T3	T3	T3	—
150	PSMH	90 °C (194 °F)	40 °C (104 °F)	T4	T4	T4	—
		90 °C (194 °F)	55 °C (131 °F)	T3	T3	T3	—
		105 °C (221 °F)	65 °C (149 °F)	T3	T3	T3	—
175	PSMH	90 °C (194 °F)	40 °C (104 °F)	T3	T3	T4	—
		90 °C (194 °F)	55 °C (131 °F)	T3	T3	T3	—
		105 °C (221 °F)	65 °C (149 °F)	T3	T3	T3	—
200	PSMH	90 °C (194 °F)	40 °C (104 °F)	T3	T3	T4	—
		105 °C (221 °F)	55 °C (131 °F)	T3	T3	T3	—
		105 °C (221 °F)	65 °C (149 °F)	T3	T3	T3	—
250	PSMH	90 °C (194 °F)	40 °C (104 °F)	T3	T3	T3	—
		90 °C (194 °F)	55 °C (131 °F)	T3	T3	T3	—

“T” Numbers Represent the Maximum Surface Temperature for Luminaires with Ex nR rating

“T” Number	T1	T2	T3	T4	T5	T6
Temp. Range (°C)	301-450	201-300	136-200	101-135	86-100	85
Temp. Range (°F)	547-842	394-572	277-392	214-275	187-212	185

Mercmaster™ III HID 50–250 Watt Luminaires

Class I, Division 2; Class II, Division 1; Simultaneous Exposure to Hazardous Conditions of Both Classifications

Maximum Temperatures in °C (°F) Obtained from Tests in a 40 °C (104 °F) Ambient, Vertical Position, Lamp Base Up, as per NEC.

CEC:
 Class I, Division 2, Groups A, B, C, D
 Class I, Zone 2 Ex nR IIC (Z)
 Class II, Division 1 and 2, Groups E, F, G
 Class III

CEC:
 Type 4X
 IP66

Fixture Selection Guide Indicates atmosphere for which fixture is suitable.

① Denotes fixture with Globe Only. ② Denotes fixture with Globe and Reflector. ③ Denotes fixture with 8" Refractor / G3 Globe

Class I, Division 2 Chemical	Ignition °C (°F) ④	Minimum Fixture "T" Number for Chemical	HPS (Watts)				PSMH (Watts)					
			50	70	100	150	70	100	175	200	250	
Group A Atmospheres												
acetylene	305 °C (581 °F)	T2	①②③	①②③	①②③	①②③	①②	①②③	①②③	①	③	①②
Group B Atmospheres												
acrolein (inhibited)	220 °C (428 °F)	T2D	①②③	①②③	①②③		①②	①②③				①②
arsine	NA ⑤											
butadiene	420 °C (788 °F)	350	①②③	①②③	①②③	①②③	①②	①②③	①②③	①②③	①②③	①②
ethylene oxide	429 °C (804 °F)	350	①②③	①②③	①②③	①②③	①②	①②③	①②③	①②③	①②③	①②
hydrogen	500 °C (932 °F)	T1	①②③	①②③	①②③	①②③	①②	①②③	①②③	①②③	①②③	①②
propylene oxide	449 °C (840 °F)	350	①②③	①②③	①②③	①②③	①②	①②③	①②③	①②③	①②③	①②
propyl nitrate	175 °C (347 °F)	T3B	①②③	①②③			①②					
Group C Atmospheres												
acetaldehyde	175 °C (347 °F)	T3B	①②③	①	③		①②					
allyl alcohol	378 °C (712 °F)	350	①②③	①②③	①②③	①②③	①②	①②③	①②③	①②③	①②③	①②
n-butylaldehyde	218 °C (424 °F)	T2D	①②③	①②③	①②③		①②	①②③				①②
carbon monoxide	609 °C (1128 °F)	T1	①②③	①②③	①②③	①②③	①②	①②③	①②③	①②③	①②③	①②
crotonaldehyde	232 °C (450 °F)	T2C	①②③	①②③	①②③	③	①②	①②③				①②
cyclopropane	498 °C (928 °F)	T1	①②③	①②③	①②③	①②③	①②	①②③	①②③	①②③	①②③	①②
diethyl ether (ethyl ether)	160 °C (320 °F)	T3C	①	③	③		①②					
diethylamine	312 °C (594 °F)	T2	①②③	①②③	①②③	①②③	①②	①②③	①②③	①	③	①②
ethylene	450 °C (842 °F)	T1	①②③	①②③	①②③	①②③	①②	①②③	①②③	①②③	①②③	①②
ethylenimine	320 °C (608 °F)	T2	①②③	①②③	①②③	①②③	①②	①②③	①②③	①	③	①②
ethyl mercaptan	300 °C (572 °F)	T2	①②③	①②③	①②③	①②③	①②	①②③	①②③	①	③	①②
ethyl sulfide	NA ⑤											
hydrogen cyanide	538 °C (1000 °F)	T1	①②③	①②③	①②③	①②③	①②	①②③	①②③	①②③	①②③	①②
hydrogen sulfide	260 °C (500 °F)	T2B	①②③	①②③	①②③	①②③	①②	①②③	①②③	①		①②
morpholine	310 °C (590 °F)	T2	①②③	①②③	①②③	①②③	①②	①②③	①②③	①	③	①②
2-nitropropane	428 °C (802 °F)	350	①②③	①②③	①②③	①②③	①②	①②③	①②③	①②③	①②③	①②
tetrahydrofuran	321 °C (610 °F)	T2	①②③	①②③	①②③	①②③	①②	①②③	①②③	①	③	①②
unsymmetrical dimethyl hydrazine	249 °C (480 °F)	T2C	①②③	①②③	①②③	③	①②	①②③				①②
Group D Atmospheres												
acetic acid (glacial)	464 °C (867 °F)	T1	①②③	①②③	①②③	①②③	①②	①②③	①②③	①②③	①②③	①②
acetone	465 °C (869 °F)	T1	①②③	①②③	①②③	①②③	①②	①②③	①②③	①②③	①②③	①②
acrylonitrile	481 °C (898 °F)	T1	①②③	①②③	①②③	①②③	①②	①②③	①②③	①②③	①②③	①②
ammonia	651 °C (1204 °F)	T1	①②③	①②③	①②③	①②③	①②	①②③	①②③	①②③	①②③	①②
benzene	498 °C (928 °F)	T1	①②③	①②③	①②③	①②③	①②	①②③	①②③	①②③	①②③	①②
butane	287 °C (549 °F)	T2A	①②③	①②③	①②③	①②③	①②	①②③	①②③	①		①②
1-butanol (butyl alcohol)	343 °C (649 °F)	325	①②③	①②③	①②③	①②③	①②	①②③	①②③	①②③	①②③	①②

This classified area suitability chart is based on NEC requirements and Appleton and UL testing. However, the ultimate decision on suitability of these fixtures for classified areas depends solely on the judgement of the owner, insurance company, inspector and/or authority having jurisdiction.

④ Ignition temperatures shown should be regarded as approximations only. Per NFPA Bulletin 325M, ignition temperatures may vary according to such factors as vapor/air mixture, size and space where ignition may occur, rate and duration of heating, oxygen concentration and other materials present.

⑤ Not Available.

Mercmaster™ III HID 50–250 Watt Luminaires

Class I, Division 2; Class II, Division 1; Simultaneous Exposure to Hazardous Conditions of Both Classifications

Maximum Temperatures in °C (°F) Obtained from Tests in a 40 °C (104 °F) Ambient, Vertical Position, Lamp Base Up, as per NEC.

CEC:
Class I, Division 2, Groups A, B, C, D
Class I, Zone 2 Ex nR IIC (Z)
Class II, Division 1 and 2, Groups E, F, G
Class III

CEC:
Type 4X
IP66

Fixture Selection Guide Indicates atmosphere for which fixture is suitable.

① Denotes fixture with Globe Only. ② Denotes fixture with Globe and Reflector. ③ Denotes fixture with 8" Refractor / G3 Globe

Class I, Division 2 Chemical	Ignition °C (°F) ④	Minimum Fixture "T" Number for Chemical	HPS (Watts)				PSMH (Watts)				
			50	70	100	150	70	100	175	200	250
Group D Atmospheres											
2-butanol (secondary butyl alcohol)	405 °C (761 °F)	350	①②③	①②③	①②③	①②③	①②	①②③	①②③	①②③	①②
n-butyl acetate	425 °C (797 °F)	350	①②③	①②③	①②③	①②③	①②	①②③	①②③	①②③	①②
isobutyl acetate	421 °C (790 °F)	350	①②③	①②③	①②③	①②③	①②	①②③	①②③	①②③	①②
sec-butyl alcohol	343 °C (649 °F)	325	①②③	①②③	①②③	①②③	①②	①②③	①②③	①②③	①②
di-isobutylene	391 °C (736 °F)	350	①②③	①②③	①②③	①②③	①②	①②③	①②③	①②③	①②
ethane	472 °C (882 °F)	T1	①②③	①②③	①②③	①②③	①②	①②③	①②③	①②③	①②
ethanol (ethyl alcohol)	363 °C (685 °F)	350	①②③	①②③	①②③	①②③	①②	①②③	①②③	①②③	①②
ethyl acetate	426 °C (799 °F)	350	①②③	①②③	①②③	①②③	①②	①②③	①②③	①②③	①②
ethylene diamine (anhydrous)	385 °C (725 °F)	350	①②③	①②③	①②③	①②③	①②	①②③	①②③	①②③	①②
ethylene dichloride	413 °C (775 °F)	350	①②③	①②③	①②③	①②③	①②	①②③	①②③	①②③	①②
gasoline (56-60 octane)	280 °C (536 °F)	T2A	①②③	①②③	①②③	①②③	①②	①②③	①②③	①	①②
heptanes	204 °C (399 °F)	T3	①②③	①②③	①②③		①②	①②③			
hexanes	223 °C (433 °F)	T2D	①②③	①②③	①②③		①②	①②③			
isoprene	395 °C (743 °F)	350	①②③	①②③	①②③	①②③	①②	①②③	①②③	①②③	①②
isopropyl ether	443 °C (829 °F)	350	①②③	①②③	①②③	①②③	①②	①②③	①②③	①②③	①②
mesityl oxide	344 °C (651 °F)	325	①②③	①②③	①②③	①②③	①②	①②③	①②③	①②③	①②
methane (natural gas)	537 °C (999 °F)	T1	①②③	①②③	①②③	①②③	①②	①②③	①②③	①②③	①②
methanol (methyl alcohol)	385 °C (725 °F)	350	①②③	①②③	①②③	①②③	①②	①②③	①②③	①②③	①②
3-methyl-1-butanol (isoamyl alcohol)	350 °C (662 °F)	350	①②③	①②③	①②③	①②③	①②	①②③	①②③	①②③	①②
methyl ethyl ketone	404 °C (759 °F)	350	①②③	①②③	①②③	①②③	①②	①②③	①②③	①②③	①②
methyl isobutyl ketone	448 °C (838 °F)	350	①②③	①②③	①②③	①②③	①②	①②③	①②③	①②③	①②
2-methyl-1-propanol (isobutyl alcohol)	415 °C (779 °F)	350	①②③	①②③	①②③	①②③	①②	①②③	①②③	①②③	①②
2-methyl-1-propanol (tertiary butyl alcohol)	478 °C (892 °F)	T1	①②③	①②③	①②③	①②③	①②	①②③	①②③	①②③	①②
petroleum naphtha ⑥	288 °C (550 °F)	T2A	①②③	①②③	①②③	①②③	①②	①②③	①②③	①	①②
pyridine	482 °C (900 °F)	T1	①②③	①②③	①②③	①②③	①②	①②③	①②③	①②③	①②
octanes	206 °C (403 °F)	T3	①②③	①②③	①②③		①②	①②③			
pentanes	260 °C (500 °F)	T2B	①②③	①②③	①②③	①②③	①②	①②③	①②③	①	①②
1-pentanol (amyl alcohol)	300 °C (572 °F)	T2	①②③	①②③	①②③	①②③	①②	①②③	①②③	①	① ③ ①②
propane	432 °C (810 °F)	350	①②③	①②③	①②③	①②③	①②	①②③	①②③	①②③	①②
1-propanol (propyl alcohol)	412 °C (774 °F)	350	①②③	①②③	①②③	①②③	①②	①②③	①②③	①②③	①②
2-propanol (isopropyl alcohol)	399 °C (750 °F)	350	①②③	①②③	①②③	①②③	①②	①②③	①②③	①②③	①②
propylene	455 °C (851 °F)	T1	①②③	①②③	①②③	①②③	①②	①②③	①②③	①②③	①②
styrene	490 °C (914 °F)	T1	①②③	①②③	①②③	①②③	①②	①②③	①②③	①②③	①②
toluene	480 °C (896 °F)	T1	①②③	①②③	①②③	①②③	①②	①②③	①②③	①②③	①②
vinyl acetate	402 °C (756 °F)	350	①②③	①②③	①②③	①②③	①②	①②③	①②③	①②③	①②
vinyl chloride	472 °C (882 °F)	T1	①②③	①②③	①②③	①②③	①②	①②③	①②③	①②③	①②
xylenes (o-xylene)	463 °C (865 °F)	T1	①②③	①②③	①②③	①②③	①②	①②③	①②③	①②③	①②

This classified area suitability chart is based on NEC requirements and Appleton and UL testing. However, the ultimate decision on suitability of these fixtures for classified areas depends solely on the judgement of the owner, insurance company, inspector and/or authority having jurisdiction.

④ Ignition temperatures shown should be regarded as approximations only. Per NFPA Bulletin 325M, ignition temperatures may vary according to such factors as vapor/air mixture, size and space where ignition may occur, rate and duration of heating, oxygen concentration and other materials present.

⑥ A saturated hydrocarbon mixture. Also known by synonyms benzine, ligroin, petroleum, ether and naptha.

Mercmaster™ III HID 50–250 Watt Luminaires

Class I, Zone 2, AEx nA nR IIC; Class 1 Zone 2, AEx nR IIC; IP66; and NEMA 4X

Maximum Temperatures in °C (°F) Obtained from Tests in a 40 °C (104 °F) Ambient, Vertical Position, Lamp Base Up.

CEC:
 Class I, Division 2, Groups A, B, C, D
 Class I, Zone 2 Ex nR IIC (Z)
 Class II, Division 1 and 2, Groups E, F, G
 Class III

CEC:
 Type 4X
 IP66

Fixture Selection Guide Indicates atmosphere for which fixture is suitable.

② Denotes fixture with Globe and Reflector. ③ Denotes fixture with 8" Refractor.

Class I, Division 2 Chemical	Ignition °C (°F) ④	Minimum Fixture "T" Number for Chemical	HPS (Watts)				PSMH (Watts)				
			50	70	100	150	70	100	175	200	250
Group IIC											
acetylene	305 °C (581 °F)	T2	②③	②③	②③	②③	②③	②③	②③	②③	②③
acetylene	300 °C (572 °F)	T2	②③	②③	②③	②③	②③	②③	②③	②③	②③
hydrogen	500 °C (932 °F)	T1	②③	②③	②③	②③	②③	②③	②③	②③	②③
Group IIB											
ethylene	490 °C (914 °F)	T1	②③	②③	②③	②③	②③	②③	②③	②③	②③
butadiene 1.3	425 °C (797 °F)	T2	②③	②③	②③	②③	②③	②③	②③	②③	②③
carbon monoxide coke oven gas	560 °C (1040 °F)	T1	②③	②③	②③	②③	②③	②③	②③	②③	②③
diethyl ether (ethyl ether)	160 °C (320 °F)	T4	②③	②③	②③	②③	②③				
ethylene	450 °C (842 °F)	T1	②③	②③	②③	②③	②③	②③	②③	②③	②③
ethylenimine ethylene oxide	425 °C (797 °F)	T2	②③	②③	②③	②③	②③	②③	②③	②③	②③
Group IIA											
acetone	465 °C (869 °F)	T1	②③	②③	②③	②③	②③	②③	②③	②③	②③
amyl acetate	375 °C (707 °F)	T2	②③	②③	②③	②③	②③	②③	②③	②③	②③
ammonia	651 °C (1204 °F)	T1	②③	②③	②③	②③	②③	②③	②③	②③	②③
benzene	498 °C (928 °F)	T1	②③	②③	②③	②③	②③	②③	②③	②③	②③
butane	287 °C (549 °F)	T3	②③	②③	②③	②③	②③	②③	②③	②③	
1-butanol (butyl alcohol)	343 °C (649 °F)	T2	②③	②③	②③	②③	②③	②③	②③	②③	②③
n-butyl acetate cyclohexane	260 °C (500 °F)	T3	②③	②③	②③	②③	②③	②③	②③	②③	
ethyl methyl ketone	515 °C (959 °F)	T1	②③	②③	②③	②③	②③	②③	②③	②③	②③
ethanol (ethyl alcohol)	363 °C (685 °F)	T2	②③	②③	②③	②③	②③	②③	②③	②③	②③
ethyl acetate	426 °C (799 °F)	T1	②③	②③	②③	②③	②③	②③	②③	②③	②③
heptanes	204 °C (399 °F)	T3	②③	②③	②③	②③	②③	②③	②③	②③	
hexanes	223 °C (433 °F)	T3	②③	②③	②③	②③	②③	②③	②③	②③	
isoprene isobutanol	430 °C (806 °F)	T2	②③	②③	②③	②③	②③	②③	②③	②③	②③
mesityl oxide methyl acetate	500 °C (932 °F)	T1	②③	②③	②③	②③	②③	②③	②③	②③	②③
methanol (methyl alcohol)	385 °C (725 °F)	T2	②③	②③	②③	②③	②③	②③	②③	②③	②③
n-propyl acetate	500 °C (932 °F)	T1	②③	②③	②③	②③	②③	②③	②③	②③	②③
n-butyl acetate	420 °C (788 °F)	T2	②③	②③	②③	②③	②③	②③	②③	②③	②③
pentanes	260 °C (500 °F)	T3	②③	②③	②③	②③	②③	②③	②③	②③	
propane	432 °C (810 °F)	T2	②③	②③	②③	②③	②③	②③	②③	②③	②③
xylenes (o-xylene)	463 °C (865 °F)	T1	②③	②③	②③	②③	②③	②③	②③	②③	②③

This classified area suitability chart is based on NEC requirements and Appleton and UL testing. However, the ultimate decision on suitability of these fixtures for classified areas depends solely on the judgement of the owner, insurance company, inspector and/or authority having jurisdiction.

④ Ignition temperatures shown should be regarded as approximations only. Per NFPA Bulletin 325M, ignition temperatures may vary according to such factors as vapor/air mixture, size and space where ignition may occur, rate and duration of heating, oxygen concentration and other materials present.



Mercmaster™ III HID 50–250 Watt Luminaires

50 W, 70 W, 100 W, 150 W HPS

High Reactance, High Power Factor (min. P.F. 90%). Heat-Resistant Prismatic Glass Globe or Closed Prismatic Glass Refractor. Mogul Base Lamps.

CEC:
Class I, Division 2, Groups A, B, C, D
Class I, Zone 2 Ex nR IIC (Z)
Class II, Division 1 and 2, Groups E, F, G
Class III

CEC:
Type 4X
IP66

Lamp Type	Lamp Watts	Hub Size (Inches)	Catalog Numbers ③④⑤		
			with Globe	with Type V 8" Refractor or G3 Globe ②	
Pendant — One Hub, Rigid Mounting ①					
	HPS	50	3/4 1	KPAL5075 KPAL5010	KPAL5075J5 KPAL5010J5
	HPS	70	3/4 1	KPAL7075 KPAL7010	KPAL7075J5 KPAL7010J5
	HPS	100	3/4 1	KPAL1075 KPAL1010	KPAL1075J5 KPAL1010J5
	HPS	150	3/4 1	KPAL1575 KPAL1510	KPAL1575J5 KPAL1510J5
Pendant Cone — One Hub, Rigid Mounting					
	HPS	50	3/4 1	KPDL5075 KPDL5010	KPDL5075J5 KPDL5010J5
	HPS	70	3/4 1	KPDL7075 KPDL7010	KPDL7075J5 KPDL7010J5
	HPS	100	3/4 1	KPDL1075 KPDL1010	KPDL1075J5 KPDL1010J5
	HPS	150	3/4 1	KPDL1575 KPDL1510	KPDL1575J5 KPDL1510J5
Ceiling — Five Hubs, Four Close-Up Plugs					
	HPS	50	3/4 1	KPCL5075 KPCL5010	KPCL5075J5 KPCL5010J5
	HPS	70	3/4 1	KPCL7075 KPCL7010	KPCL7075J5 KPCL7010J5
	HPS	100	3/4 1	KPCL1075 KPCL1010	KPCL1075J5 KPCL1010J5
	HPS	150	3/4 1	KPCL1575 KPCL1510	KPCL1575J5 KPCL1510J5

① For Flexible Pendant Mount, change **A** to **F** in catalog number (except 50 W HPS).

② To order fixtures with large globe change **J5** to **G3**; for fixture with NEMA Type I or NEMA Type III refractor, change final digit **5** in catalog number to **1** or **3**.

③ Add the following voltage and frequency designation before **Z** suffix:

Lamp Type	Lamp Watts	Voltage Suffixes						
		C2	C3	C6	C7	MT	TT	XP
HPS	50	—	—	—	—	X	X	X
HPS	70	—	—	—	—	X	X	X
HPS	100	—	—	X	X	X	X	X
HPS	150	X	X	X	X	X	X	X
PSMH	70	—	—	—	—	X	X	X
PSMH	100	—	—	—	—	X	X	X
PSMH	150	—	—	—	—	X	X	X
PSMH	175	—	—	—	—	X	X	X
PSMH	200	—	—	—	—	X	X	X
PSMH	250	—	—	—	—	X	X	X
MH ⑥	175	X	X	X	X	—	X	—
MH ⑥	250	X	X	X	X	—	X	—

Voltages:

C2 - 208 V 60 Hz, CWI

C6 - 480 V 60 Hz, CWI

MT - 120/208/240/277 V 60 Hz

C3 - 240 V 60 Hz, CWI

C7 - 600 V 60 Hz, CWI

TT - 120/277/347 V 60 Hz, CWA

LB - Incandescent, 120 V 60 Hz

XP - 220-240 V, 50Hz, CWA

④ Add **Z** for factory sealed restricted breathing protection (Ex nR)

⑤ For fixtures with guards, add letter **G** before adding voltage designation.

⑥ Mercury vapor and metal halide luminaires are not available for purchase within the United States. Please check with your countries governing legislation regarding allowable lamp types before ordering.

Mercmaster™ III HID 50–250 Watt Luminaires

50 W, 70 W, 100 W, 150 W HPS

High Reactance, High Power Factor (min. P.F. 90%). Heat-Resistant Prismatic Glass Globe or Closed Prismatic Glass Refractor. Mogul Base Lamps.

CEC:
Class I, Division 2, Groups A, B, C, D
Class I, Zone 2 Ex nR IIC (Z)
Class II, Division 1 and 2, Groups E, F, G
Class III

CEC:
Type 4X
IP66

Lamp Type	Lamp Watts	Hub Size (Inches)	Catalog Numbers ③④⑤ with Type V 8" Refractor with Globe or G3 Globe ②		
			with Globe	with G3 Globe ②	
Wall — Five Hubs, Four Close-Up Plugs					
	HPS	50	3/4	KPWL5075	KPWL5075J5
			1	KPWL5010	KPWL5010J5
	HPS	70	3/4	KPWL7075	KPWL7075J5
			1	KPWL7010	KPWL7010J5
HPS	100	3/4	KPWL1075	KPWL1075J5	
		1	KPWL1010	KPWL1010J5	
HPS	150	3/4	KPWL1575	KPWL1575J5	
		1	KPWL1510	KPWL1510J5	
25° Stanchion — One Hub					
	HPS	50	1-1/4	KPSL50125	KPSL50125J5
			1-1/2	KPSL50150	KPSL50150J5
	HPS	70	1-1/4	KPSL70125	KPSL70125J5
			1-1/2	KPSL70150	KPSL70150J5
HPS	100	1-1/4	KPSL10125	KPSL10125J5	
		1-1/2	KPSL10150	KPSL10150J5	
HPS	150	1-1/4	KPSL15125	KPSL15125J5	
		1-1/2	KPSL15150	KPSL15150J5	
90° Stanchion — One Hub					
	HPS	50	1-1/4	KPRL50125	KPRL50125J5
			1-1/2	KPRL50150	KPRL50150J5
	HPS	70	1-1/4	KPRL70125	KPRL70125J5
			1-1/2	KPRL70150	KPRL70150J5
HPS	100	1-1/4	KPRL10125	KPRL10125J5	
		1-1/2	KPRL10150	KPRL10150J5	
HPS	150	1-1/4	KPRL15125	KPRL15125J5	
		1-1/2	KPRL15150	KPRL15150J5	

② To order fixtures with large globe change **J5** to **G3**; for fixture with NEMA Type I or NEMA Type III refractor, change final digit 5 in catalog number to 1 or 3.
③ Add the following voltage and frequency designation before **Z** suffix:

Lamp Type	Lamp Watts	Voltage Suffixes						
		C2	C3	C6	C7	MT	TT	XP
HPS	50	—	—	—	—	X	X	X
HPS	70	—	—	—	—	X	X	X
HPS	100	—	—	X	X	X	X	X
HPS	150	X	X	X	X	X	X	X
PSMH	70	—	—	—	—	X	X	X
PSMH	100	—	—	—	—	X	X	X
PSMH	150	—	—	—	—	X	X	X
PSMH	175	—	—	—	—	X	X	X
PSMH	200	—	—	—	—	X	X	X
PSMH	250	—	—	—	—	X	X	X
MH ⑥	175	X	X	X	X	—	X	—
MH ⑥	250	X	X	X	X	—	X	—

Voltagess:
C2 - 208 V 60 Hz, CWI
C3 - 240 V 60 Hz, CWI
C6 - 480 V 60 Hz, CWI
C7 - 600 V 60 Hz, CWI
LB - Incandescent, 120 V 60 Hz
MT - 120/208/240/277 V 60 Hz
TT - 120/277/347 V 60 Hz, CWA
XP - 220-240 V, 50Hz, CWA

④ Add **Z** for factory sealed restricted breathing protection (Ex nR)

⑤ For fixtures with guards, add letter **G** before adding voltage designation.

⑥ Mercury vapor and metal halide luminaires are not available for purchase within the United States. Please check with your countries governing legislation regarding allowable lamp types before ordering.

Mercmaster™ III HID 50–250 Watt Luminaires

70 W, 100 W, 150 W, 175 W, 200 W, 250 W PSMH



High Reactance, High Power Factor (min. P.F. 90%). Heat-Resistant Prismatic Glass Globe or Closed Prismatic Glass Refractor. Mogul Base Lamps

CEC:
Class I, Division 2, Groups A, B, C, D
Class I, Zone 2 Ex nR IIC (Z)
Class II, Division 1 and 2, Groups E, F, G
Class III

CEC:
Type 4X
IP66

Appleton®

HID/AREA: NEC/CEC ENCLOSED AND GASKETED

	Lamp Type	Lamp Watts	Hub Size (Inches)	Catalog Numbers ③④⑤	
				with Globe	with Type V 8" Refractor ②
Pendant — One Hub, Rigid Mounting ①					
	PSMH	70	3/4 1	KPAH7075 KPAH7010	KPAH7075J5 KPAH7010J5
	PSMH	100	3/4 1	KPAH1075 KPAH1010	KPAH1075J5 KPAH1010J5
	PSMH	150	3/4 1	KPAP1575 KPAP1510	KPAP1575J5 KPAP1510J5
	PSMH	175	3/4 1	KPAP1775 KPAP1710	KPAP1775J5 KPAP1710J5
	PSMH	200	3/4 1	KPAP2075 KPAP2010	KPAP2075J5 KPAP2010J5
	PSMH	250 ⑥	3/4 1	KPAP2575 KPAP2510	KPAP2575J5 KPAP2510J5
Pendant Cone — One Hub, Rigid Mounting					
	PSMH	70	3/4 1	KPDH7075 KPDH7010	KPDH7075J5 KPDH7010J5
	PSMH	100	3/4 1	KPDH1075 KPDH1010	KPDH1075J5 KPDH1010J5
	PSMH	150	3/4 1	KPDP1575 KPDP1510	KPDP1575J5 KPDP1510J5
	PSMH	175	3/4 1	KPDP1775 KPDP1710	KPDP1775J5 KPDP1710J5
	PSMH	200	3/4 1	KPDP2075 KPDP2010	KPDP2075J5 KPDP2010J5
	PSMH	250 ⑥	3/4 1	KPDP2575 KPDP2510	KPDP2575J5 KPDP2510J5
Ceiling — Five Hubs, Four Close-Up Plugs					
	PSMH	70	3/4 1	KPCH7075 KPCH7010	KPCH7075J5 KPCH7010J5
	PSMH	100	3/4 1	KPCH1075 KPCH1010	KPCH1075J5 KPCH1010J5
	PSMH	150	3/4 1	KPCP1575 KPCP1510	KPCP1575J5 KPCP1510J5
	PSMH	175	3/4 1	KPCP1775 KPCP1710	KPCP1775J5 KPCP1710J5
	PSMH	200	3/4 1	KPCP2075 KPCP2010	KPCP2075J5 KPCP2010J5
	PSMH	250 ⑥	3/4 1	KPCP2575 KPCP2510	KPCP2575J5 KPCP2510J5

① For Flexible Pendant Mount, change **A** to **F** in catalog number (except 50 W HPS).

② To order fixtures with large globe change **J5** to **G3**; for fixture with NEMA Type I or NEMA Type III refractor, change final digit **5** in catalog number to **1** or **3**.

③ Add the following voltage and frequency designation before **Z** suffix:

Lamp Type	Lamp Watts	Voltage Suffixes							
		C2	C3	C6	C7	MT	TT	XP	
HPS	50	—	—	—	—	X	X	X	
HPS	70	—	—	—	—	X	X	X	
HPS	100	—	—	X	X	X	X	X	
HPS	150	X	X	X	X	X	X	X	
PSMH	70	—	—	—	—	X	X	X	
PSMH	100	—	—	—	—	X	X	X	
PSMH	150	—	—	—	—	X	X	X	
PSMH	175	—	—	—	—	X	X	X	
PSMH	200	—	—	—	—	X	X	X	
PSMH	250	—	—	—	—	X	X	X	
MH ⑦	175	X	X	X	X	—	X	—	
MH ⑦	250	X	X	X	X	—	X	—	

Voltages:

C2 - 208 V 60 Hz, CWI

C3 - 240 V 60 Hz, CWI

C6 - 480 V 60 Hz, CWI

C7 - 600 V 60 Hz, CWI

LB - Incandescent, 120 V 60 Hz

MT - 120/208/240/277 V 60 Hz

TT - 120/277/347 V 60 Hz, CWA

XP - 220-240 V, 50Hz, CWA

④ Add **Z** for factory sealed restricted breathing protection (Ex nR)

⑤ For fixtures with guards, add letter **G** before adding voltage designation.

⑥ Available in MT and TT only. MT and TT fixtures are not UL Listed.

⑦ Mercury vapor and metal halide luminaires are not available for purchase within the United States. Please check with your countries governing legislation regarding allowable lamp types before ordering.



Mercmaster™ III HID 50–250 Watt Luminaires

70 W, 100 W, 150 W, 175 W, 200 W, 250 W PSMH

High Reactance, High Power Factor (min. P.F. 90%). Heat-Resistant Prismatic Glass Globe or Closed Prismatic Glass Refractor. Mogul Base Lamps.

CEC:
Class I, Division 2, Groups A, B, C, D
Class I, Zone 2 Ex nR IIC (Z)
Class II, Division 1 and 2, Groups E, F, G
Class III

CEC:
Type 4X
IP66

	Lamp Type	Lamp Watts	Hub Size (Inches)	Catalog Numbers ③④⑤	
				with Globe	with Type V 8" Refractor ②
Wall — Five Hubs, Four Close-Up Plugs					
	PSMH	70	3/4 1	KPWH7075 KPWH7010	KPWH7075J5 KPWH7010J5
	PSMH	100	3/4 1	KPWH1075 KPWH1010	KPWH1075J5 KPWH1010J5
	PSMH	150	3/4 1	KPWP1575 KPWP1510	KPWP1575J5 KPWP1510J5
	PSMH	175	3/4 1	KPWP1775 KPWP1710	KPWP1775J5 KPWP1710J5
	PSMH	200	3/4 1	KPWP2075 KPWP2010	KPWP2075J5 KPWP2010J5
	PSMH	250 ⑥	3/4 1	KPWP2575 KPWP2510	KPWP2575J5 KPWP2510J5
25° Stanchion — One Hub					
	PSMH	70	1-1/4 1-1/2	KPSH70125 KPSH70150	KPSH70125J5 KPSH70150J5
	PSMH	100	1-1/4 1-1/2	KPSH10125 KPSH10150	KPSH10125J5 KPSH10150J5
	PSMH	150	1-1/4 1-1/2	KPSP15125 KPSP15150	KPSP15125J5 KPSP15150J5
	PSMH	175	1-1/4 1-1/2	KPSP17125 KPSP17150	KPSP17125J5 KPSP17150J5
	PSMH	200	1-1/4 1-1/2	KPSP20125 KPSP20150	KPSP20125J5 KPSP20150J5
	PSMH	250 ⑥	1-1/4 1-1/2	KPSP25125 KPSP25150	KPSP25125J5 KPSP25150J5
90° Stanchion — One Hub					
	PSMH	70	1-1/4 1-1/2	KPRH70125 KPRH70150	KPRH70125J5 KPRH70150J5
	PSMH	100	1-1/4 1-1/2	KPRH10125 KPRH10150	KPRH10125J5 KPRH10150J5
	PSMH	150	1-1/4 1-1/2	KPRP15125 KPRP15150	KPRP15125J5 KPRP15150J5
	PSMH	175	1-1/4 1-1/2	KPRP17125 KPRP17150	KPRP17125J5 KPRP17150J5
	PSMH	200	1-1/4 1-1/2	KPRP20125 KPRP20150	KPRP20125J5 KPRP20150J5
	PSMH	250 ⑥	1-1/4 1-1/2	KPRP25125 KPRP25150	KPRP25125J5 KPRP25150J5

② To order fixtures with large globe change **J5** to **G3**; for fixture with NEMA Type I or NEMA Type III refractor, change final digit 5 in catalog number to 1 or 3.

③ Add the following voltage and frequency designation before **Z** suffix:

Lamp Type	Lamp Watts	Voltage Suffixes						
		C2	C3	C6	C7	MT	TT	XP
HPS	50	—	—	—	—	X	X	X
HPS	70	—	—	—	—	X	X	X
HPS	100	—	—	X	X	X	X	X
HPS	150	X	X	X	X	X	X	X
PSMH	70	—	—	—	—	X	X	X
PSMH	100	—	—	—	—	X	X	X
PSMH	150	—	—	—	—	X	X	X
PSMH	175	—	—	—	—	X	X	X
PSMH	200	—	—	—	—	X	X	X
PSMH	250	—	—	—	—	X	X	X
MH ⑦	175	X	X	X	X	—	X	—
MH ⑦	250	X	X	X	X	—	X	—

Voltages:

C2 - 208 V 60 Hz, CWI

C3 - 240 V 60 Hz, CWI

C6 - 480 V 60 Hz, CWI

C7 - 600 V 60 Hz, CWI

LB - Incandescent, 120 V 60 Hz

MT - 120/208/240/277 V 60 Hz

TT - 120/277/347 V 60 Hz, CWA

XP - 220-240 V, 50Hz, CWA

④ Add **Z** for factory sealed restricted breathing protection (Ex nR)

⑤ For fixtures with guards, add letter **G** before adding voltage designation.

⑥ Available in MT and TT only. MT and TT fixtures are not UL Listed.

⑦ Mercury vapor and metal halide luminaires are not available for purchase within the United States. Please check with your countries governing legislation regarding allowable lamp types before ordering.

Mercmaster™ III HID 50–250 Watt Luminaires

175 W, 250 W MH

High Reactance, High Power Factor (min. P.F. 90%). Heat-Resistant Prismatic Glass Globe or Closed Prismatic Glass Refractor. Mogul Base Lamps

CEC:
Class I, Division 2, Groups A, B, C, D
Class I, Zone 2 Ex nR IIC (Z)
Class II, Division 1 and 2, Groups E, F, G
Class III

CEC:
Type 4X
IP66

Lamp Type ⑦	Lamp Watts	Hub Size (Inches)	Catalog Numbers ③④⑤	
			with Globe	with Type V 8" Refractor ②

Pendant – One Hub, Rigid Mounting ①



MH	175	3/4	KPAH1775	KPAH1775J5
		1	KPAH1710	KPAH1710J5
MH	250 ⑥	3/4	KPAH2575	KPAH2575J5
		1	KPAH2510	KPAH2510J5

Pendant Cone – One Hub, Rigid Mounting



MH	175	3/4	KPDH1775	KPDH1775J5
		1	KPDH1710	KPDH1710J5
MH	250 ⑥	3/4	KPDH2575	KPDH2575J5
		1	KPDH2510	KPDH2510J5

Ceiling – Five Hubs, Four Close-Up Plugs



MH	175	3/4	KPCH1775	KPCH1775J5
		1	KPCH1710	KPCH1710J5
MH	250 ⑥	3/4	KPCH2575	KPCH2575J5
		1	KPCH2510	KPCH2510J5

① For Flexible Pendant Mount, change **A** to **F** in catalog number (except 50 W HPS).

② To order fixtures with large globe change **J5** to **G3**; for fixture with NEMA Type I or NEMA Type III refractor, change final digit **5** in catalog number to **1** or **3**.

③ Add the following voltage and frequency designation before **Z** suffix:

Lamp Type	Lamp Watts	Voltage Suffixes						
		C2	C3	C6	C7	MT	TT	XP
HPS	50	—	—	—	—	X	X	X
HPS	70	—	—	—	—	X	X	X
HPS	100	—	—	X	X	X	X	X
HPS	150	X	X	X	X	X	X	X
PSMH	70	—	—	—	—	X	X	X
PSMH	100	—	—	—	—	X	X	X
PSMH	150	—	—	—	—	X	X	X
PSMH	175	—	—	—	—	X	X	X
PSMH	200	—	—	—	—	X	X	X
PSMH	250	—	—	—	—	X	X	X
MH ⑦	175	X	X	X	X	—	X	—
MH ⑦	250	X	X	X	X	—	X	—

Voltages:

C2 - 208 V 60 Hz, CWI

C3 - 240 V 60 Hz, CWI

C6 - 480 V 60 Hz, CWI

C7 - 600 V 60 Hz, CWI

LB - Incandescent, 120 V 60 Hz

MT - 120/208/240/277 V 60 Hz

TT - 120/277/347 V 60 Hz, CWA

XP - 220-240 V, 50Hz, CWA

④ Add **Z** for factory sealed restricted breathing protection (Ex nR)

⑤ For fixtures with guards, add letter **G** before adding voltage designation.

⑥ Available in MT and TT only. MT and TT fixtures are not UL Listed.

⑦ Mercury vapor and metal halide luminaires are not available for purchase within the United States. Please check with your countries governing legislation regarding allowable lamp types before ordering.

Mercmaster™ III HID 50–250 Watt Luminaires

175 W, 250 W MH

High Reactance, High Power Factor (min. P.F. 90%). Heat-Resistant Prismatic Glass Globe or Closed Prismatic Glass Refractor. Mogul Base Lamps

CEC:
Class I, Division 2, Groups A, B, C, D
Class I, Zone 2 Ex nR IIC (Z)
Class II, Division 1 and 2, Groups E, F, G
Class III

CEC:
Type 4X
IP66

Lamp Type ⑦	Lamp Watts	Hub Size (Inches)	Catalog Numbers ③④⑤	
			with Globe	with Type V 8" Refractor ②

Wall — Five Hubs, Four Close-Up Plugs



MH	175	3/4	KPWH1775	KPWH1775J5
		1	KPWH1710	KPWH1710J5
MH	250 ⑥	3/4	KPWH2575	KPWH2575J5
		1	KPWH2510	KPWH2510J5

25° Stanchion — One Hub



MH	175	1-1/4	KPSH17125	KPSH17125J5
		1-1/2	KPSH17150	KPSH17150J5
MH	250 ⑥	1-1/4	KPSH25125	KPSH25125J5
		1-1/2	KPSH25150	KPSH25150J5

90° Stanchion — One Hub



MH	175	1-1/4	KPRH17125	KPRH17125J5
		1-1/2	KPRH17150	KPRH17150J5
MH	250 ⑥	1-1/4	KPRH25125	KPRH25125J5
		1-1/2	KPRH25150	KPRH25150J5

Shown with Globe and Optional Guard

② To order fixtures with large globe change **J5** to **G3**; for fixture with NEMA Type I or NEMA Type III refractor, change final digit **5** in catalog number to **1** or **3**.

③ Add the following voltage and frequency designation before **Z** suffix:

Lamp Type	Lamp Watts	C2	C3	C6	Voltage Suffixes				XP
					C7	MT	TT		
HPS	50	—	—	—	—	X	X	X	
HPS	70	—	—	—	—	X	X	X	
HPS	100	—	—	X	X	X	X	X	
HPS	150	X	X	X	X	X	X	X	
PSMH	70	—	—	—	—	X	X	X	
PSMH	100	—	—	—	—	X	X	X	
PSMH	150	—	—	—	—	X	X	X	
PSMH	175	—	—	—	—	X	X	X	
PSMH	200	—	—	—	—	X	X	X	
PSMH	250	—	—	—	—	X	X	X	
MH ⑦	175	X	X	X	X	—	X	—	
MH ⑦	250	X	X	X	X	—	X	—	

Voltages:

C2 - 208 V 60 Hz, CWI

C3 - 240 V 60 Hz, CWI

C6 - 480 V 60 Hz, CWI

C7 - 600 V 60 Hz, CWI

LB - Incandescent, 120 V 60 Hz

MT - 120/208/240/277 V 60 Hz

TT - 120/277/347 V 60 Hz, CWA

XP - 220-240 V, 50Hz, CWA

④ Add **Z** for factory sealed restricted breathing protection (Ex nR)

⑤ For fixtures with guards, add letter **G** before adding voltage designation.

⑥ Available in MT and TT only. MT and TT fixtures are not UL Listed.

⑦ Mercury vapor and metal halide luminaires are not available for purchase within the United States. Please check with your countries governing legislation regarding allowable lamp types before ordering.

Mercmaster™ III HID 50–250 Watt PRE-PAK Luminaires

Factory-Assembled Fixtures

For 70 W, 100 W or 150 W High Pressure Sodium Lamps, or 100 W or 175 W Pulse Start Metal Halide Lamps. Mogul Base Lamps.

CEC:
 Class I, Division 2, Groups A, B, C, D
 Class I, Zone 2 Ex nR IIC (Z)
 Class II, Division 1 and 2, Groups E, F, G
 Class III

CEC:
 Type 4X
 IP66

These pre-packaged fixture component combinations are delivered fully assembled and packed in a single carton. They are available with or without lamp, and with choice of globe or NEMA Type I, III or V refractors – all with or without guards. PRE-PAK units simplify ordering, stocking and shipping, and result in savings on job-site assembly and installation time and costs.

Catalog numbers do not include mounting hood or reflector. For mounting hood and reflectors selection, see below and order separately. Hood and Reflector will be packaged separately.



PRE-PAK Fixtures ①

Lamp Type and Watts	Ballast Assembly with Globe Only	Ballast Assembly with Globe and Guard	Ballast Assembly with G3 Globe Only	Ballast Assembly with Refractor Only ③	Ballast Assembly with Refractor and Guard
100 W PSMH ②	KPBU17P-G2N-TT-L	KPBU17P-G2G-TT-L	—	KPBU17P-J5N-TT-L	KPBU17P-J5G-TT-L
175 W PSMH	KPBU20P-G2N-TT-L	KPBU20P-G2G-TT-L	—	KPBU20P-J5N-TT-L	KPBU20P-J5G-TT-L
70 W HPS	KPBU70L-G2N-TT-L	KPBU70L-G2G-TT-L	—	KPBU70L-J5N-TT-L	KPBU70L-J5G-TT-L
100 W HPS	KPBU10L-G2N-TT-L	KPBU10L-G2G-TT-L	KPBU10L-G3N-TT-L	KPBU10L-J5N-TT-L	KPBU10L-J5G-TT-L
150 W HPS	KPBU15L-G2N-TT-L	KPBU15L-G2G-TT-L	—	KPBU15L-J5N-TT-L	KPBU15L-J5G-TT-L
175 W MH ④	KPBU17H-G2N-TT-L	KPBU17H-G2G-TT-L	—	KPBU17H-J5N-TT-L	KPBU17H-J5G-TT-L
250 W MH ④	KPBU25H-G2N-TT-L	KPBU25H-G2G-TT-L	—	KPBU25H-J5N-TT-L	KPBU25H-J5G-TT-L

Mounting Hoods

Description	Hub Size (Inches)	Catalog Number
Pendant One Hub, Rigid Mounting	3/4 1	KPA-75 KPA-100
Pendant – Flexible One Hub, Flexible Mounting	3/4 1	KPAF-75 KPAF-100
Pendant Cone One Hub, Rigid	3/4 1	KPCH-75 KPCH-100
Ceiling Five Hubs, Four Close-Up Plugs	3/4 1	KPC-75 KPC-100
Wall Five Hubs, Four Close-Up Plugs	3/4 1	KPWB-75 KPWB-100
25° Stanchion One Hub	1-1/4 1-1/2	KPS-125 KPS-150
90° Stanchion One Hub	1-1/4 1-1/2	KPST-125 KPST-150

White Polyester Reflectors

Description	Catalog Number
Standard Dome For Globe Fixtures	KR2-ST
30° Angle For Globe Fixtures	KR2-AN
Standard Dome For Glass Refractor Fixtures	CMR-4ST
30° Angle For Glass Refractor Fixtures	CMR-4AN

① All catalog numbers above are fixtures without lamp. To order fixture complete with appropriate installed lamp, add suffix L to catalog number. All PRE-PAK fixtures include multi-tap ballast for operation on 120 V, 277 V OR 347 V lines. Fixture component combinations listed are furnished completely assembled in a single carton.

② 100 W fixtures use ED-28 mogul base lamps.

③ Refractor catalog numbers listed are for NEMA Type V. To order fixture with Type III refractor, change J5 in catalog number to J3; for Type I refractor, change J5 to J1.

④ Mercury vapor and metal halide luminaires are not available for purchase within the United States. Please check with your countries governing legislation regarding allowable lamp types before ordering.

Mercmaster™ III HID 50–250 Watt Luminaires

High Pressure Sodium, Pulse Start Metal Halide and Metal Halide

Listed for simultaneous exposure to combustible dusts and flammable gases or vapors.

CEC:

Class I, Division 2, Groups A, B, C, D
 Class I, Zone 2 Ex nR IIC (Z)
 Class II, Division 1 and 2, Groups E, F, G
 Class III

CEC:

Type 4X
 IP66

Mounting Hoods			
	Description	Hub Size (Inches)	Catalog Number
Pendant		One Hub, Rigid Mounting	KPA-75
			KPA-100
Pendant – Flexible		One Hub, Flexible Mounting	KPAF-75
			KPAF-100
Pendant Cone		One Hub, Rigid	KPCH-75
			KPCH-100
Ceiling		Five Hubs, Four Close-Up Plugs	KPC-75
			KPC-100
Wall		Five Hubs, Four Close-Up Plugs	KPWB-75
			KPWB-100
25° Stanchion		One Hub	KPS-125
			KPS-150
90° Stanchion		One Hub	KPST-125
			KPST-150

 **Appleton**

HID/AREA: NEC/CEC ENCLOSED AND GASKETED

Mercmaster™ III HID 50–250 Watt Luminaires

High Pressure Sodium, Pulse Start Metal Halide and Metal Halide

Listed for simultaneous exposure to combustible dusts and flammable gases or vapors.

CEC:
 Class I, Division 2, Groups A, B, C, D
 Class I, Zone 2 Ex nR IIC (Z)
 Class II, Division 1 and 2, Groups E, F, G
 Class III

CEC:
 Type 4X
 IP66

Ballast Bodies



Ballast Body for Glass Globe (shown)

High Pressure Sodium
 High Power Factor (Min. P.F. 90%)



Ballast Body for Glass Refractor or G3 Globe (shown)

Pulse Start Metal Halide
 Super Constant Wattage Autotransformer (Min. P.F. 90%)

Lamp Type	Lamp Watts	Catalog Number ②④⑤		Voltage Suffixes							
		For Globe	For G3 Globe ①/ Refractor	C2	C3	C6	C7	LB	MT	TT	XP
HPS	50 ③	KPB50L	KPBR50L	—	—	—	—	—	X	X	X
HPS	70 ③	KPB70L	KPBR70L	—	—	—	—	—	X	X	X
HPS	100 ③	KPB100L	KPBR100L	—	—	X	X	—	X	X	X
HPS	150 ③	KPB150L	KPBR150L	X	X	X	X	—	X	X	X
PSMH	70	KPB70H	KPBR70H	—	—	—	—	—	X	X	X
PSMH	100	KPB100H	KPBR100H	—	—	—	—	—	X	X	X
PSMH	150	KPB150P	KPBR150P	—	—	—	—	—	X	X	X
PSMH	175	KPB175P	KPBR175P	—	—	—	—	—	X	X	X
PSMH	200	KPB200P	KPBR200P	—	—	—	—	—	X	X	X
PSMH ⑥	250	KPBG250P	KPBR250P	—	—	—	—	—	X	X	X
MH ⑦	175	KPB175H	KPBR175H	X	X	X	X	—	—	X	—
MH ⑦	250	KPB250H	KPBR250H	X	X	X	X	—	—	X	—

Voltages:

- C2** - 208 V 60 Hz, CWI
- C3** - 240 V 60 Hz, CWI
- C6** - 480 V 60 Hz, CWI
- C7** - 600 V 60 Hz, CWI
- LB** - Incandescent, 120 V 60 Hz
- MT** - 120/208/240/277 V 60 Hz
- TT** - 120/277/347 V 60 Hz, CWA
- XP** - 220-240 V, 50Hz, CWA

- ① For HPS version fixtures only.
- ② After voltage suffix add: **-S** for Smart Starter.
- ③ After voltage suffix add: **-R** for ballast body with Hot Restrike Ignitor.
- ④ Add **-E** after voltage suffix for ballast body with provision for Quartz Emergency Light. Not suitable for hazardous locations.
- ⑤ Add **Z** for factory sealed restricted breathing protection (Ex nR)
- ⑥ MT and TT ballast bodies are not UL Listed for 250W PSMH version fixtures only.
- ⑦ Mercury vapor and metal halide luminaires are not available for purchase within the United States. Please check with your countries governing legislation regarding allowable lamp types before ordering.

Mercmaster™ III HID 50–250 Watt Luminaires

High Pressure Sodium, Pulse Start Metal Halide and Metal Halide





Listed for simultaneous exposure to combustible dusts and flammable gases or vapors.

CEC:

Class I, Division 2, Groups A, B, C, D
 Class I, Zone 2 Ex nR IIC (Z)
 Class II, Division 1 and 2, Groups E, F, G
 Class III

CEC:

Type 4X
 IP66

		Description	Catalog Number
Prismatic Glass Globes — Heat-Resistant			
 Glass Globe	For use in areas where fixture is subject to extreme thermal shock Heat-Resistant	Clear	VPGL-2HR
		Amber	VPGL-2AM
		Blue	VPGL-2BL
		Green	VPGL-2GR
		Red	VPGL-2RE
 G3 Glass Globe		Clear	VPGL3HR
Tuff-Skin® Coated Prismatic Glass Globes — For Non-Classified Areas			
 Tuff-Skin® Glass Globe		Clear	VPGL-2HRT
Polycarbonate Globes — Impact-Resistant ①			
 Polycarbonate Globe	Use 100 watt lamp max. Do not use in ambients exceeding 25 °C (77 °F).	Clear	VPGL-2PL
		Amber	VPGL-2AMPL
		Green	VPGL-2GRPL
		Red	VPGL-2REPL

Appleton®

HID/AREA: NEC/CEC ENCLOSED AND GASKETED

① Polycarbonate globes are shatter-resistant – for use in processing plants, canneries, dairies, bakeries or anywhere broken glass would prove a hazard. Ideally suited for areas where vandalism, high replacement and high maintenance costs are a problem. Do not use in ambients exceeding +25 °C (+77 °F). For burning in vertical base-up positions only.

Mercmaster™ III HID 50–250 Watt Luminaires

High Pressure Sodium, Pulse Start Metal Halide and Metal Halide

Listed for simultaneous exposure to combustible dusts and flammable gases or vapors.

CEC:
 Class I, Division 2, Groups A, B, C, D
 Class I, Zone 2 Ex nR IIC (Z)
 Class II, Division 1 and 2, Groups E, F, G
 Class III

CEC:
 Type 4X
 IP66

	Light Distribution	IES/NEMA Distribution Curves	Catalog Number
--	--------------------	------------------------------	----------------

Closed Prismatic Glass Refractors — Heat-Resistant



Glass Refractor

NEMA Type I

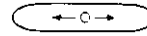

LPG-R1

NEMA Type III

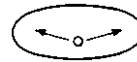

LPG-R3

NEMA Type V



LPG-R5

Closed Prismatic Polymeric Refractors

For use with PSMH lamps, 100 W max. +40 °C (+104 °F) max. ambient temperature.

Suitable for Class II, Division 1 and 2, Groups F, G; NEMA 4X, UL 1598A Marine Type Electric Fixtures Outside Type (Salt Water)



Polymeric Refractor

NEMA Type II

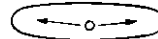

LPRF-2CP

NEMA Type III



LPRF-3CP

NEMA Type IV



LPRF-4CP

NEMA Type V



LPRF-5CP







Mercmaster™ III HID 50–250 Watt Luminaires

High Pressure Sodium, Pulse Start Metal Halide and Metal Halide

Listed for simultaneous exposure to combustible dusts and flammable gases or vapors.

CEC:
 Class I, Division 2, Groups A, B, C, D
 Class I, Zone 2 Ex nR IIC (Z)
 Class II, Division 1 and 2, Groups E, F, G
 Class III

CEC:
 Type 4X
 IP66

Item		Description	Catalog Number
White Polyester Reflectors			
 Standard Dome	 30° Angle	For Globe Fixtures	Standard Dome KR2-ST
			Deep Dome KR2-DD ①
			30° Angle KR2-AN
		For Glass Refractor Fixtures ②	Standard Dome CMR-4ST
			Deep Dome CMR-4DD ①
			30° Angle CMR-4AN
Guards			
 Globe Guard	 Refractor Guard	Globe Guard	KGU2
		G3 Globe/Refractor Guard	KRG2
Replacement Globe Gaskets – Silicone Rubber			
 Globe Gaskets		Globe Gasket	VPGL-GK
		G3 Globe/Refractor Gasket	KRF-GK
Retrofit Pendant Mounting Adapter			
 Mounting Adapter		Permits use of Mercmaster III pendant hood with 3/4" hub on existing V-51 mounting hood.	LPAD-1

① Dark Skies Compliant.

② Fixtures with refractors are not UL Listed when used with reflectors.

Mercmaster™ III HID 50–250 Watt Luminaires

High Pressure Sodium, Pulse Start Metal Halide and Metal Halide

Listed for simultaneous exposure to combustible dusts and flammable gases or vapors.

CEC:
 Class I, Division 2, Groups A, B, C, D
 Class I, Zone 2 Ex nR IIC (Z)
 Class II, Division 1 and 2, Groups E, F, G
 Class III

CEC:
 Type 4X
 IP66

Ballast Housing Weights

Lamp Watts	HPS — Wt. kg (lb) ①②	PSMH — Wt. kg (lb) ①②
Globe Housing with Ballast		
50	5.7 (12.6)	—
70	6.8 (15.0)	6.9 (15.2)
100	7.3 (16.0)	7.4 (16.3)
150	7.7 (17.0)	7.6 (16.8)
175	—	7.8 (17.2)
200	—	8.2 (18.0)
250	—	8.4 (18.5)
Reflector Housing with Ballast		
50	5.9 (13.0)	—
70	7.0 (15.4)	7.1 (15.7)
100	7.5 (16.5)	7.6 (16.8)
150	7.9 (17.4)	7.8 (17.2)
175	—	8.1 (17.9)
200	—	8.4 (18.5)
250	—	8.6 (19.0)

Component and Accessory Weights

Item	Wt. kg (lb) ①
Mounting Hoods	
Pendant	1.0 (2.20)
Pendant Cone	1.1 (2.43)
Ceiling	1.4 (3.09)
Wall	1.8 (3.97)
25° Stanchion	1.5 (3.31)
Straight Stanchion	1.7 (3.75)
Refractors, Globes and Guards	
8" Glass Refractor/G3 Globe	2.4 (5.29)
Glass Globe	1.7 (3.75)
Globe Guard	0.5 (1.10)
Refractor Guard	0.5 (1.10)
Reflectors	
Standard Dome	1.1 (2.43)
30° Angle	1.1 (2.43)

① Weights are approximate.

② Add 0.5 kg (1 lbs) for HPS fixtures with Hot Restrike. Add 0.1 kg (0.25 lbs) for Quartz Emergency Light.

Mercmaster™ III HID 50–250 Watt Luminaires

High Pressure Sodium, Pulse Start Metal Halide and Metal Halide

Listed for simultaneous exposure to combustible dusts and flammable gases or vapors.

CEC:
Class I, Division 2, Groups A, B, C, D
Class I, Zone 2 Ex nR IIC (Z)
Class II, Division 1 and 2, Groups E, F, G
Class III

CEC:
Type 4X
IP66

Electrical Specifications

Line Voltage	Type of Ballast ①	Starting Amps	Operating Amps	Total Watts
50 Watt High Pressure Sodium				
120	HX-HPF	0.58	0.58	64
208	HX-HPF	0.35	0.33	64
240	HX-HPF	0.31	0.29	64
277	HX-HPF	0.25	0.25	64
347	HX-HPF	0.26	0.21	68
70 Watt High Pressure Sodium				
120	HX-HPF	0.90	0.82	94
208	HX-HPF	0.50	0.48	94
240	HX-HPF	0.44	0.41	94
277	HX-HPF	0.35	0.36	94
347	HX-HPF	0.30	0.30	94
480	HX-HPF	0.21	0.21	94
100 Watt High Pressure Sodium				
120	HX-HPF	1.30	1.15	130
208	HX-HPF	0.76	0.67	130
240	HX-HPF	0.66	0.60	130
277	HX-HPF	0.60	0.52	130
347	HX-HPF	0.45	0.39	130
480	HX-HPF	0.33	0.31	135
480	C.W.I.	0.17	0.30	130
600	C.W.I.	0.14	0.24	130
150 Watt High Pressure Sodium ②				
120	HX-HPF	2.00	1.70	188
208	HX-HPF	1.15	0.95	188
240	HX-HPF	1.00	0.85	188
277	HX-HPF	0.85	0.72	188
347	HX-HPF	0.52	0.56	188
480	HX-HPF	0.50	0.47	189
480	C.W.I.	0.25	0.42	190
600	C.W.I.	0.19	0.35	190
70 Watt Pulse Start Metal Halide				
120	HX-HPF	0.80	0.85	95
208	HX-HPF	0.50	0.52	95
240	HX-HPF	0.43	0.44	95
277	HX-HPF	0.39	0.39	95
347	HX-HPF	0.20	0.28	88
480	HX-HPF	0.26	0.23	95
100 Watt Pulse Start Metal Halide				
120	HX-HPF	1.20	1.15	130
208	HX-HPF	0.70	0.70	130
240	HX-HPF	0.61	0.58	130
277	HX-HPF	0.55	0.50	130
347	HX-HPF	0.40	0.40	129
480	HX-HPF	0.30	0.35	140

Line Voltage	Type of Ballast ①	Starting Amps	Operating Amps	Total Watts
150 Watt Pulse Start Metal Halide				
120	HX-HPF	1.75	1.60	188
208	HX-HPF	1.30	1.00	188
240	HX-HPF	0.85	0.80	188
277	HX-HPF	0.77	0.70	188
347 ③	Super C.W.A.	0.65	0.55	185
480	Super C.W.A.	0.45	0.42	185
175 Watt Pulse Start Metal Halide				
120	Super C.W.A.	0.90	1.78	199
208	Super C.W.A.	0.50	1.08	199
240	Super C.W.A.	0.35	0.89	199
277	Super C.W.A.	0.30	0.76	199
347 ③	Super C.W.A.	0.25	0.65	208
480	Super C.W.A.	0.25	0.50	213
175 Watt Metal Halide ④				
120	C.W.A.	1.30	1.80	210
208	C.W.A.	0.75	1.04	210
240	C.W.A.	0.65	0.90	210
277	C.W.A.	0.55	0.80	210
347	C.W.A.	0.50	0.65	210
480	C.W.I.	0.20	0.45	215
600	C.W.I.	0.16	0.37	215
175 Watt Metal Halide ④				
120	Super C.W.A.	1.30	1.80	213
208	Super C.W.A.	0.75	1.10	213
240	Super C.W.A.	0.65	0.90	213
277	Super C.W.A.	0.55	0.80	213
480	Super C.W.A.	0.35	0.45	213
250 Watt Metal Halide ④				
120	Super C.W.A.	1.20	2.60	298
208	Super C.W.A.	0.65	1.50	298
240	Super C.W.A.	0.60	1.30	298
277	Super C.W.A.	0.50	1.12	298
480	Super C.W.A.	0.30	0.65	298

① C.W.A. – Constant Wattage Autotransformer. HX-HPF – High Reactance High Power Factor Autotransformer. Super C.W.A. – Super Constant Wattage Autotransformer.

② 150 W HPS units equipped with ballasts to operate 55 volt lamps only.

③ Certified to meet the Canadian Electrical Code (CEC) only.

④ Mercury vapor and metal halide luminaires are not available for purchase within the United States. Please check with your countries governing legislation regarding allowable lamp types before ordering.

Mercmaster™ III HID 50–250 Watt Luminaires

High Pressure Sodium, Pulse Start Metal Halide and Metal Halide

Listed for simultaneous exposure to combustible dusts and flammable gases or vapors.

CEC:
 Class I, Division 2, Groups A, B, C, D
 Class I, Zone 2 Ex nR IIC (Z)
 Class II, Division 1 and 2, Groups E, F, G
 Class III

CEC:
 Type 4X
 IP66

Dimensions in Millimeters (Inches)

**Pendant
(Rigid or Flex)**

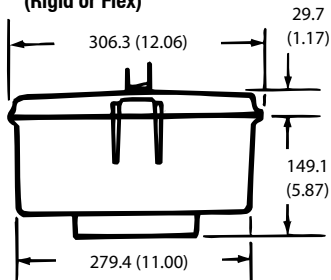

Ceiling

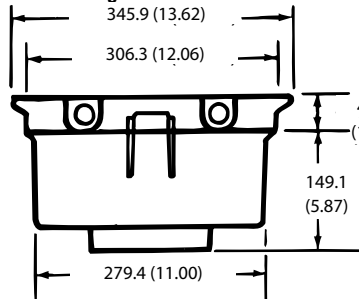

Cone

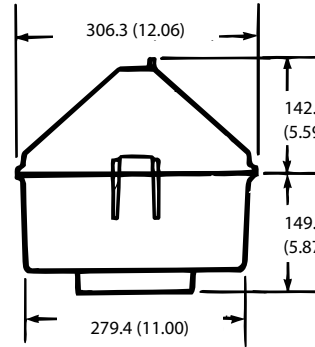

Wall

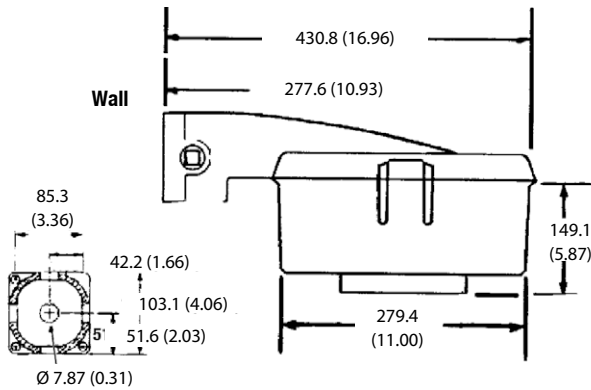

Globe/Guard/Reflector

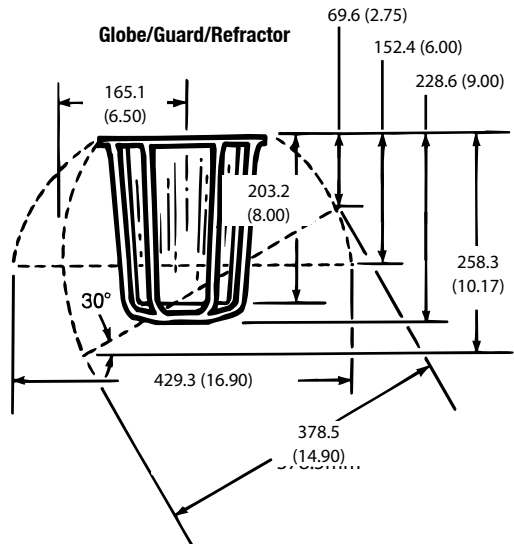

90° Straight Stanchion

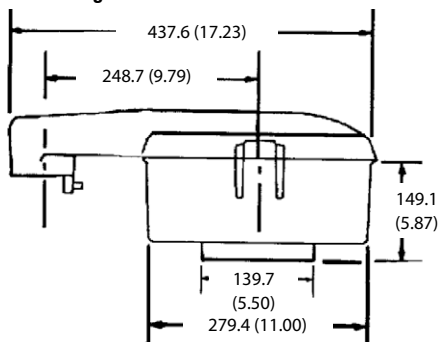

**8" Globe/Reflector
Body/Guard**

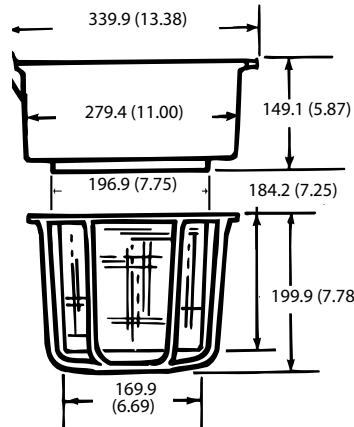

Polymeric Refractor

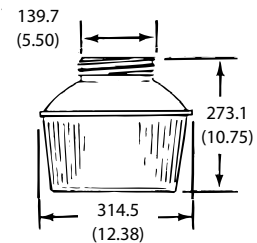

25° Angle Stanchion

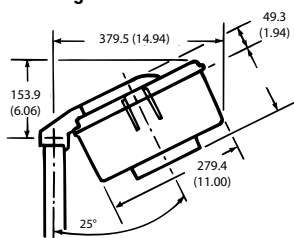

Appleton

HID/AREA: NEC/CEC ENCLOSED AND GASKETED

PCD2 Series Factory Sealed Hazardous Location Photocontrol

For use in Class I, Division 2, Groups A, B, C, D locations

Maintains Class I, Division 2 rating for Mercmaster III – Low Profile, Mercmaster III, and Mercmaster III – 400 Series Luminaires, Mercmaster LED

NEC/CEC:
Class I, Division 2, Groups A, B, C, D
NEMA 4X

Applications

- Encapsulated photocontrol provides automatic dusk-to-dawn lighting control in Class I, Division 2 locations.
- Typical applications include walkways, security areas and any other outdoor lighting application.
- For use with Mercmaster III – Low Profile, Mercmaster III, and Mercmaster III – 400 Series Luminaires.
- For remote mounting in FS Boxes.

- 50-400 W HID, incandescent or fluorescent, 50/60 Hz.
- 1000 V.A. Voltage/Ampere
- Minimum time delay: 15 seconds to eliminate nuisance tripping.
- Provided with (3) 18AWG stranded leads 152.4 mm (6 in) in length.
- Will fit through standard 1/2" knockout.
- Supplied with locknut and gasket.

Features



- Factory sealed design eliminates the need for an explosionproof enclosure.
- Can be easily installed in the field.
- Solid state design for performance and reliability.
- Available for 120, 208, 240, or 277 volts.

Materials

- Encapsulated with epoxy sealing compound
- FS: aluminum

NEC/CEC Certifications and Compliances

- UL Standard: 1604 – Hazardous (Classified) Locations
- cULus Recognized

	Voltage Range	Max VA	Max Current Amps	Suffix Designation Catalog Number
Factory-Installed Photocontrol - Not for ceiling or pendant cone. <i>Add to fixture catalog after voltage; i.e.: KPWBL1075MTH1.</i>				
	120 V, 50/60 Hz	1000	—	H1
	208 V, 50/60 Hz	1000	—	H2
	240 V, 50/60 Hz	1000	—	H3
	277 V, 50/60 Hz	1000	—	H4
Photocontrol for Field Installation				
	120 V, 50/60 Hz	1000	8.3 Amp	PC120D2
	208 V, 50/60 Hz	1000	4.8 Amp	PC247D2
	240 V, 50/60 Hz	1000	4.2 Amp	
	277 V, 50/60 Hz	1000	3.6 Amp	
Photocontrol in FS Cover for Use with FS/FD Box <i>Supplied with two stainless steel screws. For neoprene gasket, order catalog number FS-GKR-1N.</i>				
	120 V, 50/60 Hz	1000	8.3 Amp	FSKA-PC120D2
	208, 50/60 Hz	1000	4.8 Amp	FSKA-PC247D2
	240 V, 50/60 Hz	1000	4.2 Amp	
	277 V, 50/60 Hz	1000	3.6 Amp	

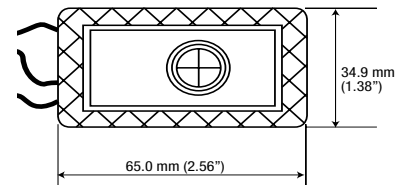
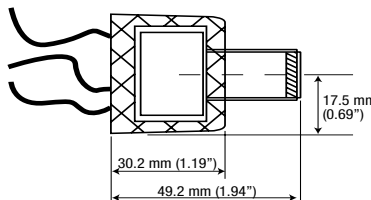
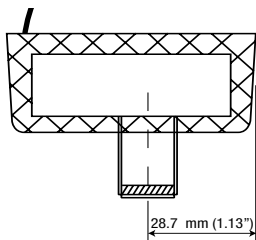

Mercmaster™ III HID 50–250 Watt Luminaires

150 W HPS

* Photometric data is based on fixtures with 150-watt clear High Pressure Sodium lamp (16,000 lumen). For candlepower values of fixtures with other HPS lamps, use the following multipliers: for 70 W (6,400 lumen) HPS lamp – 0.40; for 50 W (4,000 lumen) HPS lamp – 0.25. For candlepower values of fixture with guard, multiply by 0.95.

CEC:
 Class I, Division 2, Groups A, B, C, D
 Class I, Zone 2 Ex nR IIC (Z)
 Class II, Division 1 and 2, Groups E, F, G
 Class III

CEC:
 Type 4X
 IP66

Photometric Data

Zone	Lumens	Total Luminaire Efficiency = 86.1%			
0-10	50.74	CIE Type – Semi-Direct			
10-20	164.55	Plane		Spacing Criteria	
20-30	310.47				
30-40	611.05	0-180	2.82		
40-50	961.13	90-270	2.82		
50-60	1308.18	Diagonal	2.80		
60-70	1542.35	Zonal Lumen Summary			
70-80	1716.10				
80-90	1799.18	Zone	Lumens	% Lamp	% Fixture
90-100	1802.19	0-30	525.75	3.3	3.8
100-110	1676.86	0-40	1136.81	7.1	8.3
110-120	1379.11	0-60	3406.12	21.3	24.7
120-130	441.46	0-90	8463.75	52.9	61.4
130-140	9.61	90-120	4858.16	30.4	35.3
140-150	3.33	90-130	5299.62	33.1	38.5
150-160	0.74	90-150	5312.56	33.2	38.5
160-170	0.00	90-180	5313.30	33.2	38.6
170-180	0.00	180-0	13777.05	86.1	100.0

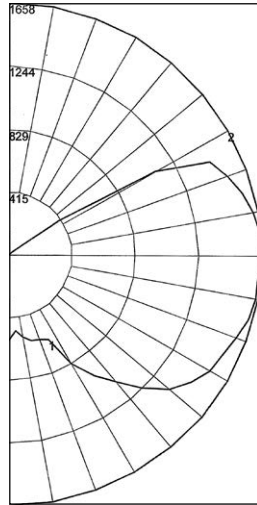

REPORT NUMBER: **KP15LG**

Lamps: 150 W High Pressure Sodium with Globe only *

Coefficients of Utilization – Zonal Cavity Method

Effective Floor Cavity Reflectance 0.20

% Ceiling Rcc	% Walls Rw	80		70		50		30		10		0						
		70	50	30	10	70	50	30	10	50	30		10					
0	95	95	95	95	89	89	89	89	77	77	77	67	67	67	57	57	57	53
1	81	74	69	64	75	69	64	59	59	55	51	50	47	44	42	39	37	33
2	71	62	54	47	65	57	50	44	49	43	38	41	36	32	33	30	27	23
3	64	52	44	37	58	48	41	34	41	35	30	34	29	25	28	24	20	17
4	57	45	36	30	53	42	34	28	35	29	24	29	24	20	24	19	16	13
5	52	40	31	24	48	37	29	23	31	24	19	26	20	16	21	16	13	10
6	48	35	26	20	44	32	25	19	27	21	16	23	17	13	18	14	11	8
7	44	31	23	17	40	29	21	16	24	18	14	20	15	11	16	12	9	7
8	40	28	20	15	37	26	19	14	22	16	12	18	13	10	15	11	8	6
9	38	25	18	13	35	24	17	12	20	14	10	17	12	8	14	10	7	5
10	35	23	16	11	32	22	15	11	18	13	9	15	11	7	13	9	6	4

Zone	Lumens	Total Luminaire Efficiency = 73.6%			
0-10	266.98	CIE Type – Direct			
10-20	799.41	Plane		Spacing Criteria	
20-30	1337.05				
30-40	1732.06	0-180	1.46		
40-50	2067.60	90-270	1.46		
50-60	2317.60	Diagonal	1.68		
60-70	2210.81	Zonal Lumen Summary			
70-80	866.77				
80-90	145.09	Zone	Lumens	% Lamp	% Fixture
90-100	14.46	0-30	2403.44	15.0	20.4
100-110	8.75	0-40	4135.50	25.8	35.1
110-120	7.93	0-60	8520.70	53.3	72.3
120-130	4.51	0-90	11743.37	73.4	99.7
130-140	2.16	90-120	31.14	0.2	0.3
140-150	0.48	90-130	35.65	0.2	0.3
150-160	0.00	90-150	38.29	0.2	0.3
160-170	0.00	90-180	38.29	0.2	0.3
170-180	0.00	180-0	11781.65	73.6	100.0

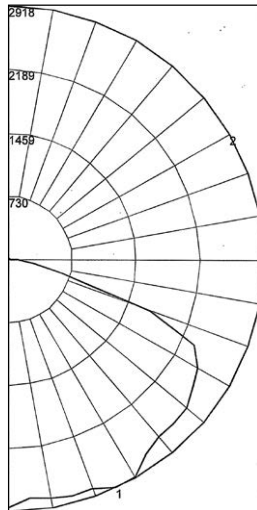

REPORT NUMBER: **KP15LST**

Lamps: 150 W High Pressure Sodium with Standard Dome Reflector *

Coefficients of Utilization – Zonal Cavity Method

Effective Floor Cavity Reflectance 0.20

% Ceiling Rcc	% Walls Rw	80		70		50		30		10		0						
		70	50	30	10	70	50	30	10	50	30		10					
0	88	88	88	88	86	86	86	86	82	82	82	78	78	78	75	75	75	73
1	79	76	72	69	77	74	71	68	71	68	66	68	66	64	65	64	62	60
2	71	65	59	55	69	63	58	54	61	57	53	58	55	52	56	53	50	49
3	64	56	49	44	62	55	49	44	52	47	43	50	46	42	48	45	41	40
4	58	49	42	36	57	48	41	36	46	40	36	44	39	35	42	38	35	33
5	53	43	36	31	52	42	35	30	40	35	30	39	34	30	38	33	29	28
6	49	38	31	26	47	38	31	26	36	30	26	35	30	25	34	29	25	24
7	45	34	27	23	44	34	27	23	33	27	22	31	26	22	30	26	22	20
8	42	31	24	20	40	31	24	20	30	24	20	29	23	19	28	23	19	18
9	39	28	22	18	38	28	22	18	27	21	17	26	21	17	25	21	17	16
10	36	26	20	16	35	26	20	16	25	19	16	24	19	16	23	19	15	14

Mercmaster™ III HID 50–250 Watt Luminaires

150 W HPS

* Photometric data is based on fixtures with 150-watt clear High Pressure Sodium lamp (16,000 lumen). For candlepower values of fixtures with other HPS lamps, use the following multipliers: for 70 W (6,400 lumen) HPS lamp – 0.40; for 50 W (4,000 lumen) HPS lamp – 0.25. For candlepower values of fixture with guard, multiply by 0.95.

CEC:
 Class I, Division 2, Groups A, B, C, D
 Class I, Zone 2 Ex nR IIC (Z)
 Class II, Division 1 and 2, Groups E, F, G
 Class III

CEC:
 Type 4X
 IP66

Photometric Data

Zone	Lumens	Total Luminaire Efficiency = 73.1%	
0-10	222.62	CIE Type – Direct	
10-20	664.6	Plane	Spacing Criteria
20-30	1084.32		
30-40	1536.55	0-180	2.06
40-50	1771.90	90-270	1.58
50-60	1771.51	Diagonal	1.62
60-70	1668.93		
70-80	1422.36	Zonal Lumen Summary	
80-90	994.54	Zone	Lumens % Lamp % Fixture
90-100	432.23	0-30	1971.54 12.3 16.9
100-110	104.58	0-40	3508.09 21.9 30.0
110-120	20.99	0-60	7051.50 44.1 60.3
120-130	1.21	0-90	11137.33 69.6 95.2
130-140	0.04	90-120	557.80 3.5 4.8
140-150	0.00	90-130	559.01 3.5 4.8
150-160	0.00	90-150	559.04 3.5 4.8
160-170	0.00	90-180	559.04 3.5 4.8
170-180	0.00	180-0	11696.38 73.1 100.0

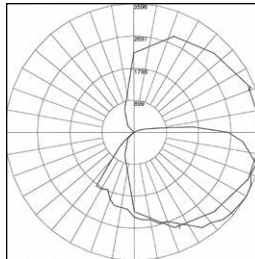

REPORT NUMBER: **KP15LAN**

Lamps: 150 W High Pressure Sodium with
 30° Angle Dome Reflector *

Coefficients of Utilization – Zonal Cavity Method

Effective Floor Cavity Reflectance 0.20

% Ceiling Rcc	% Walls Rw	80		70		50		30		10		0						
		70	50	30	10	70	50	30	10	50	30	10	50	30	10	0		
0	86	86	86	86	84	84	84	84	79	79	79	75	75	75	71	71	71	70
1	76	71	67	63	73	69	65	62	65	62	59	62	59	57	58	56	54	52
2	68	60	54	49	65	58	53	48	55	50	46	52	48	45	49	46	43	41
3	61	52	45	39	59	50	44	39	48	42	37	45	40	36	43	39	35	33
4	55	45	38	32	53	44	37	32	42	36	31	39	34	30	37	33	29	27
5	50	40	33	27	49	39	32	27	37	31	26	35	30	25	33	29	25	23
6	46	36	28	23	45	35	28	23	33	27	22	31	26	22	30	25	21	20
7	43	32	25	20	41	31	25	20	30	24	19	28	23	19	27	22	19	17
8	40	29	22	18	38	28	22	17	27	21	17	26	21	17	25	20	16	15
9	37	26	20	16	36	26	20	16	25	19	15	24	19	15	23	18	15	13
10	35	24	18	14	33	24	18	14	23	17	14	22	17	13	21	16	13	12

Zone	Lumens	Total Luminaire Efficiency = 81.1%	
0-10	72.83	CIE Type – Semi- Direct	
10-20	222.26	Plane	Spacing Criteria
20-30	380.73		
30-40	621.11	0-180	1.98
40-50	852.53	90-270	1.98
50-60	1765.29	Diagonal	3.40
60-70	3192.58		
70-80	2366.61	Zonal Lumen Summary	
80-90	1230.65	Zone	Lumens % Lamp % Fixture
90-100	450.14	0-30	675.83 4.2 5.2
100-110	712.41	0-40	1296.93 8.1 10.0
110-120	499.15	0-60	3914.76 24.5 30.2
120-130	323.44	0-90	10704.60 66.9 82.5
130-140	185.00	90-120	1661.70 10.4 12.8
140-150	81.31	90-130	1985.14 12.4 15.3
150-160	21.08	90-150	2251.45 14.1 15.3
160-170	2.81	90-180	2275.34 14.2 17.5
170-180	0.00	180-0	12979.94 81.1 100.0

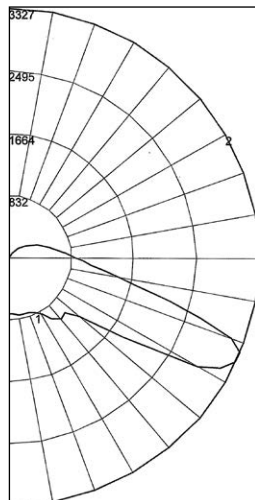

REPORT NUMBER: **KP15LJR5**

Lamps: 150 W High Pressure Sodium with
 8" Prismatic Glass Refractor – NEMA Type V *

Coefficients of Utilization – Zonal Cavity Method

Effective Floor Cavity Reflectance 0.20

% Ceiling Rcc	% Walls Rw	80		70		50		30		10		0						
		70	50	30	10	70	50	30	10	50	30	10	50	30	10	0		
0	93	93	93	93	89	89	89	89	82	82	82	76	76	76	70	70	70	67
1	80	73	68	63	76	70	65	61	64	60	56	58	55	52	53	50	48	45
2	69	59	51	45	65	56	49	43	51	45	40	46	41	37	41	37	34	31
3	61	49	40	33	57	47	38	32	42	35	29	38	32	27	34	29	25	22
4	54	42	32	25	51	40	31	24	35	28	22	32	26	21	28	23	19	16
5	49	36	27	20	46	34	26	19	31	23	18	27	21	16	24	19	15	12
6	45	32	23	16	42	30	22	16	27	20	14	24	18	13	21	16	12	10
7	41	28	20	14	38	27	19	13	24	17	12	21	15	11	19	14	10	8
8	38	25	17	12	36	24	16	11	22	15	10	19	14	9	17	12	8	6
9	35	23	15	10	33	22	15	10	20	13	9	18	12	8	16	11	7	5
10	33	21	14	9	31	20	13	9	18	12	8	16	11	7	15	10	6	5

Mercmaster™ III HID 50–250 Watt Luminaires

175 W PSMH

* Photometric data is based on fixtures with a 175-watt clear Pulse Start Metal Halide lamp (17,500 lumen). For candlepower values of fixtures with other PSMH lamps, use the following multipliers: for a 100 W (8,500 lumen) PSMH lamp – 0.49; for a 70 W (6,200 lumen) PSMH lamp – 0.36; for a 200 W (21,000 lumen) PSMH lamp – 1.2. For candlepower values of fixture with guard, multiply by 0.95.

CEC:
 Class I, Division 2, Groups A, B, C, D
 Class I, Zone 2 Ex nR IIC (Z)
 Class II, Division 1 and 2, Groups E, F, G
 Class III

CEC:
 Type 4X
 IP66

Photometric Data

Zone	Lumens	Total Luminaire Efficiency = 75.4%
0-10	57.98	CIE Type – General Diffuse
10-20	217.30	
20-30	372.71	
30-40	696.29	
40-50	1009.65	
50-60	1226.57	
60-70	1473.76	
70-80	1757.30	
80-90	1902.34	
90-100	1946.09	
100-110	1829.51	
110-120	1657.20	
120-130	750.27	
130-140	14.15	
140-150	4.47	
150-160	0.52	
160-170	1.35	
170-180	0.18	

Zonal Lumen Summary			
Zone	Lumens	% Lamp	% Fixture
0-30	647.99	3.7	4.3
0-40	1344.28	7.7	9.0
0-60	3580.49	20.5	24.0
0-90	8713.89	49.8	58.4
90-120	5432.80	31.0	36.4
90-130	6183.06	35.3	41.4
90-150	6201.69	35.4	41.6
90-180	6203.74	35.4	41.6
180-0	14917.63	85.2	100.0

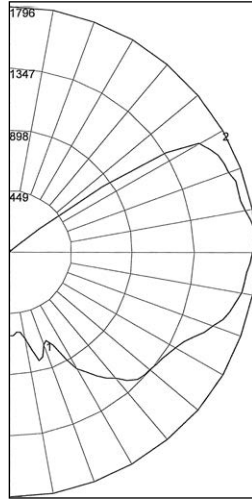

REPORT NUMBER: **KP17PG**

Lamps: 175 W Pulse Start Metal Halide with Globe only *

Coefficients of Utilization – Zonal Cavity Method

Effective Floor Cavity Reflectance 0.20

% Ceiling Rcc	80	70				50				30				10				0
		70	50	30	10	70	50	30	10	70	50	30	10	70	50	30	10	
0	93	93	93	93	87	87	87	87	75	75	75	64	64	64	54	54	54	50
1	79	73	68	63	73	68	63	59	58	54	50	48	45	43	40	37	35	31
2	70	61	54	47	65	57	50	44	48	42	38	39	35	32	32	29	26	22
3	63	52	44	37	58	48	41	35	40	34	29	33	28	24	27	23	20	16
4	57	45	37	30	52	42	34	28	35	29	24	29	24	20	23	19	16	12
5	52	40	31	25	47	37	29	23	31	24	20	25	20	16	20	16	13	10
6	47	35	27	21	43	32	25	19	27	21	17	22	17	14	18	14	11	8
7	44	31	23	18	40	29	22	17	24	18	14	20	15	12	16	12	9	7
8	40	28	21	15	37	26	19	14	22	16	12	18	14	10	15	11	8	6
9	37	26	18	13	34	24	17	13	20	15	11	17	12	9	13	10	7	5
10	35	23	16	12	32	22	15	11	18	13	9	15	11	8	12	9	6	4

Zone	Lumens	Total Luminaire Efficiency = 72.3%
0-10	285.95	CIE Type – Direct
10-20	876.46	
20-30	1472.88	
30-40	1924.39	
40-50	2213.42	
50-60	2305.55	
60-70	2256.32	
70-80	1115.75	
80-90	198.05	
90-100	3.56	
100-110	0.00	
110-120	0.00	
120-130	0.00	
130-140	0.00	
140-150	0.00	
150-160	0.00	
160-170	0.00	
170-180	0.00	

Plane	Spacing Criteria
0-180	1.50
90-270	1.50
Diagonal	1.66

Zonal Lumen Summary			
Zone	Lumens	% Lamp	% Fixture
0-30	2635.28	15.1	20.8
0-40	4559.67	26.1	36.0
0-60	9078.64	51.9	71.8
0-90	12648.77	72.3	100.0
90-120	3.56	0.00	0.00
90-130	3.56	0.00	0.00
90-150	3.56	0.00	0.00
90-180	3.56	0.00	0.00
180-0	12652.33	72.3	100.0

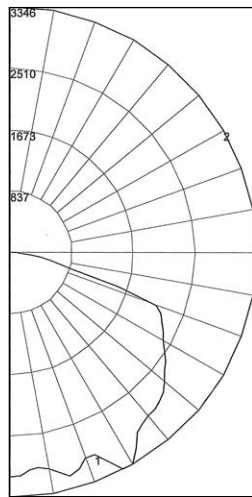

REPORT NUMBER: **KP17PST**

Lamps: 175 W Pulse Start Metal Halide with Standard Dome Reflector *

Coefficients of Utilization – Zonal Cavity Method

Effective Floor Cavity Reflectance 0.20

% Ceiling Rcc	80	70				50				30				10				0
		70	50	30	10	70	50	30	10	70	50	30	10	70	50	30	10	
0	86	86	86	86	84	84	84	84	80	80	80	77	77	77	74	74	74	72
1	78	74	71	68	76	72	69	67	69	67	65	67	64	63	64	62	61	59
2	70	63	58	54	68	62	57	53	59	55	52	57	54	50	55	52	49	48
3	63	55	48	43	61	54	48	43	51	46	42	49	45	41	47	44	41	39
4	57	48	41	36	56	47	40	35	45	39	35	43	38	34	42	37	34	32
5	52	42	35	30	51	41	35	30	40	34	30	38	33	29	37	32	29	27
6	48	38	31	26	47	37	30	26	36	30	25	34	29	25	33	29	25	23
7	44	34	27	22	43	33	27	22	32	26	22	31	26	22	30	25	22	20
8	41	31	24	20	40	30	24	20	29	24	19	28	23	19	27	23	19	18
9	38	28	22	18	37	28	22	17	27	21	17	26	21	17	25	21	17	16
10	36	26	20	16	35	25	20	16	25	19	16	24	19	15	23	19	15	14

Mercmaster™ III HID 50–250 Watt Luminaires

175 W PSMH

* Photometric data is based on fixtures with a 175-watt clear Pulse Start Metal Halide lamp (17,500 lumen). For candlepower values of fixtures with other PSMH lamps, use the following multipliers: for a 100 W (8,500 lumen) PSMH lamp – 0.49; for 70 W (6,200 lumen) PSMH lamp – 0.36; for a 200 W (21,000 lumen) PSMH lamp – 1.2. For candlepower values of fixture with guard, multiply by 0.95.

CEC:
 Class I, Division 2, Groups A, B, C, D
 Class I, Zone 2 Ex nR IIC (Z)
 Class II, Division 1 and 2, Groups E, F, G
 Class III

CEC:
 Type 4X
 IP66

Photometric Data

Zone	Lumens	Total Luminaire Efficiency = 67.1%			
0-10	240.21	CIE Type – Direct			
10-20	750.99	Plane	Spacing Criteria		
20-30	1195.39				
30-40	1662.85	0-180	1.96		
40-50	1830.67	90-270	1.70		
50-60	1740.13	Diagonal	1.56		
60-70	1571.75				
70-80	1324.18	Zonal Lumen Summary			
80-90	900.65	Zone	Lumens	% Lamp	% Fixture
90-100	367.96	0-30	2186.59	12.5	18.6
100-110	107.38	0-40	3849.44	22.0	32.8
110-120	27.79	0-60	7420.24	42.4	63.2
120-130	5.54	0-90	11216.82	64.1	95.6
130-140	4.20	90-120	503.12	2.9	4.3
140-150	4.42	90-130	508.66	2.9	4.3
150-160	2.00	90-150	517.28	3.0	4.4
160-170	1.70	90-180	521.31	3.0	4.4
170-180	0.33	180-0	11738.13	67.1	100.0

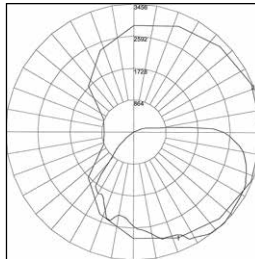

REPORT NUMBER: **KP17PAN**

Lamps: 175 W Pulse Start Metal Halide with
 30° Angle Dome Reflector *

Coefficients of Utilization – Zonal Cavity Method

Effective Floor Cavity Reflectance 0.20

% Ceiling Rcc	% Walls	Rw	80		70		50		30		10		0							
			70	50	30	10	70	50	30	10	50	30	10	0						
0			79	79	79	79	77	77	77	77	73	73	73	69	69	69	66	66	66	64
1			70	66	62	59	68	64	61	58	60	58	55	57	55	53	54	52	51	49
2			63	56	51	46	61	55	49	45	52	47	44	49	45	42	46	43	41	39
3			57	48	42	37	55	47	41	37	45	40	36	42	38	35	40	37	34	32
4			51	42	36	31	50	41	35	30	39	34	30	37	33	29	35	31	28	26
5			47	38	31	26	45	37	30	26	35	29	25	33	28	25	32	27	24	22
6			43	34	27	22	42	33	27	22	31	26	22	30	25	21	28	24	21	19
7			40	30	24	20	39	30	24	19	28	23	19	27	22	19	26	22	18	17
8			37	27	21	17	36	27	21	17	26	20	17	25	20	16	24	19	16	15
9			35	25	19	15	33	25	19	15	24	18	15	23	18	15	22	18	14	13
10			32	23	17	14	31	23	17	14	22	17	13	21	16	13	20	16	13	12

Zone	Lumens	Total Luminaire Efficiency = 81.1%			
0-10	22.77	CIE Type – Semi-Direct			
10-20	171.20	Plane	Spacing Criteria		
20-30	325.41				
30-40	531.35	0-180	1.66		
40-50	1173.62	90-270	1.64		
50-60	1165.11	Diagonal	1.92		
60-70	3171.29				
70-80	3719.35	Zonal Lumen Summary			
80-90	1751.05	Zone	Lumens	% Lamp	% Fixture
90-100	523.23	0-30	519.38	3.0	3.7
100-110	716.53	0-40	1050.73	6.0	7.4
110-120	431.18	0-60	3389.46	19.4	23.9
120-130	265.20	0-90	12031.16	68.7	84.8
130-140	142.69	90-120	1670.94	9.5	11.8
140-150	57.09	90-130	1936.15	11.1	13.7
150-160	13.48	90-150	2135.93	12.2	15.1
160-170	2.44	90-180	2152.72	12.3	15.2
170-180	0.88	180-0	14183.88	81.1	100.0

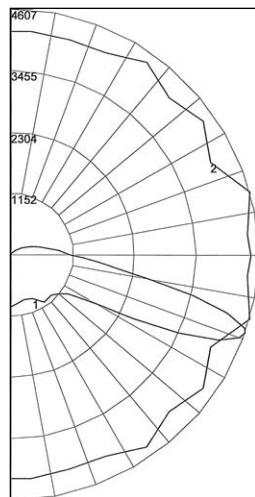

REPORT NUMBER: **KP17PJR5**

Lamps: 175 W Pulse Start Metal Halide with
 8" Prismatic Glass Refractor – NEMA Type V *

Coefficients of Utilization – Zonal Cavity Method

Effective Floor Cavity Reflectance 0.20

% Ceiling Rcc	% Walls	Rw	80		70		50		30		10		0							
			70	50	30	10	70	50	30	10	50	30	10	0						
0			94	94	94	94	90	90	90	90	83	83	83	77	77	77	71	71	71	69
1			78	71	65	60	74	68	62	57	62	57	53	57	53	49	51	48	46	43
2			67	57	48	41	63	54	46	39	49	42	36	44	38	33	39	35	31	28
3			59	46	37	29	55	44	35	28	40	32	26	35	29	24	32	26	22	19
4			52	39	30	22	49	37	28	21	33	26	20	30	23	18	26	21	16	14
5			47	34	24	17	45	32	23	17	29	21	15	26	19	14	23	17	13	10
6			43	30	21	14	41	28	20	14	25	18	12	23	16	11	20	15	10	8
7			40	27	18	12	37	23	17	11	23	16	10	20	14	9	18	13	8	6
8			37	24	16	10	35	23	15	10	20	14	9	18	12	8	16	11	7	5
9			34	22	14	9	32	21	13	8	19	12	8	17	11	7	15	10	6	4
10			32	20	12	8	30	19	12	7	17	11	7	16	10	6	14	9	5	4

HID/AREA: NEC/CEC ENCLOSED AND GASKETED

Mercmaster™ III HID 50–250 Watt Luminaires

175 W PSMH

* Photometric data is based on fixtures with a 175-watt clear Pulse Start Metal Halide lamp (17,500 lumen). For candlepower values of fixtures with other PSMH lamps, use the following multipliers: for a 100 W (8,500 lumen) PSMH lamp – 0.49; for a 70 W (6,200 lumen) PSMH lamp – 0.36; for a 200 W (21,000 lumen) PSMH lamp – 1.2. For candlepower values of fixture with guard, multiply by 0.95.

CEC:
Class I, Division 2, Groups A, B, C, D
Class I, Zone 2 Ex nR IIC (Z)
Class II, Division 1 and 2, Groups E, F, G
Class III

CEC:
Type 4X
IP66

Photometric Data

Degree	Candela	Lumens
0	657	
5	668	65
15	784	224
25	966	451
35	1194	705
45	871	711
55	1267	1142
65	1309	1303
75	1430	1509
85	1528	1661
90	1537	
95	1552	1680
105	1452	1532
115	1339	1232
125	68	143
135	19	16
145	13	11
155	7	3
165	1	1
175	2	0
180	7	

TOTAL LUMINAIRE EFFICIENCY = 70.8%
CIE Type – Semi-Direct
Spacing Criteria: 1.7

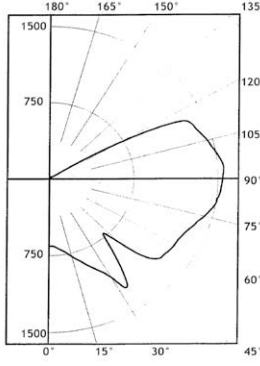

ZONAL LUMEN SUMMARY

ZONE	LUMENS	%LAMP	%FIXT.
0-30	740	4.2	6.0
0-40	1445	8.3	11.7
0-60	3297	18.8	26.6
0-90	7770	44.4	62.7
90-120	4444	25.4	35.9
90-130	4586	26.2	37.0
90-150	4613	26.4	37.2
90-180	4617	26.4	37.3
0-180	12387	70.8	100.0

REPORT NUMBER: **KPB175PG3**

Lamps: 175 W Pulse Start Metal Halide ED28 Mogul Base with G3 Globe only

COEFFICIENTS OF UTILIZATION – ZONAL CAVITY METHOD

EFFECTIVE FLOOR CAVITY REFLECTANCE 0.20

RC	80			70			50			30			10			0		
	RW	70	50	30	10	70	50	30	10	50	30	10	50	30	10			
0	78	78	78	78	73	73	73	64	64	64	56	56	56	48	48	48	44	
1	67	61	57	53	62	57	53	49	49	46	43	42	39	37	35	33	31	28
2	59	51	45	40	54	48	42	37	41	36	32	34	31	27	28	26	23	20
3	53	44	37	31	49	40	34	29	34	29	25	29	25	21	24	21	18	15
4	48	38	31	25	44	35	29	24	30	25	20	25	21	17	21	17	14	12
5	43	33	26	21	40	31	24	20	26	21	17	22	18	14	18	15	12	9
6	40	29	23	18	37	27	21	16	23	18	14	20	15	12	16	13	10	8
7	37	26	20	15	34	25	18	14	21	16	12	18	13	10	15	11	9	7
8	34	24	17	13	31	22	16	12	19	14	11	16	12	9	13	10	7	6
9	32	22	16	11	29	20	15	11	17	13	9	15	11	8	12	9	7	5
10	29	20	14	10	27	18	13	9	16	11	8	14	10	7	11	8	6	4

Degree	Candela	Lumens
0	2785	
5	2797	269
15	2902	823
25	2931	1358
35	2979	1821
45	2388	1874
55	2393	2145
65	2044	2034
75	664	856
85	150	183
90	24	
95	5	11
105	16	17
115	91	73
125	5	9
135	7	3
145	8	2
155	2	2
165	2	0
175	2	1
180	11	

TOTAL LUMINAIRE EFFICIENCY = 65.6%
CIE Type – Direct
Spacing Criteria: 1.5

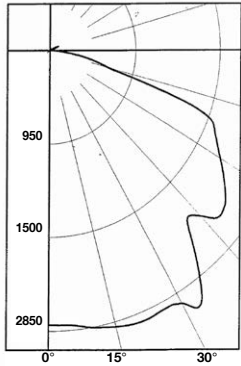

ZONAL LUMEN SUMMARY

ZONE	LUMENS	%LAMP	%FIXT.
0-30	2450	14.0	21.3
0-40	4271	24.4	37.2
0-60	8290	47.4	72.2
0-90	11363	64.9	99.0
90-120	101	0.6	0.9
90-130	110	0.6	1.0
90-150	115	0.7	1.0
90-180	118	0.7	1.0
0-180	11481	65.6	100.0

REPORT NUMBER: **KPB175PG3_ST**

Lamps: 175 W Pulse Start Metal Halide ED28 Mogul Base with G3 Globe and Standard Dome Reflector

COEFFICIENTS OF UTILIZATION – ZONAL CAVITY METHOD

EFFECTIVE FLOOR CAVITY REFLECTANCE 0.20

RC	80			70			50			30			10			0		
	RW	70	50	30	10	70	50	30	10	50	30	10	50	30	10			
0	78	78	78	78	76	76	76	73	73	73	69	69	69	66	66	66	65	
1	71	67	64	62	69	66	63	61	63	61	59	60	58	57	58	56	55	53
2	64	58	53	49	62	57	52	48	54	50	47	52	49	46	50	47	45	43
3	58	50	44	40	56	49	44	39	47	42	39	45	41	38	43	40	37	35
4	52	44	38	33	51	43	37	33	41	36	32	39	35	32	38	34	31	29
5	48	39	32	28	46	38	32	28	36	31	27	35	30	27	34	30	26	25
6	44	35	28	24	42	34	28	24	33	27	23	31	27	23	30	26	23	21
7	40	31	25	21	39	30	25	21	29	24	20	28	24	20	27	23	20	19
8	37	28	22	18	36	28	22	18	27	22	18	26	21	18	25	21	18	16
9	35	26	20	16	34	25	20	16	24	19	16	24	19	16	23	19	16	15
10	33	24	18	15	32	23	18	15	23	18	14	22	17	14	21	17	14	13

Candela Distribution

	0.0	45.0	90.0	135.0	180.0	Flux
0	2333	2333	2333	2333	2333	2333
5	2491	2467	2321	2205	2141	223
15	2904	2753	2337	2160	2099	692
25	3010	2891	2480	2242	2120	1170
35	3471	3100	2544	2027	1367	1512
45	2978	2719	1993	832	546	1427
55	3296	2939	1791	421	154	1533
65	3153	2801	776	74	0	1349
75	3175	2621	392	3	0	1140
85	2729	967	117	5	0	709
90	1601	662	11	5	5	
95	790	461	3	11	16	247
105	413	175	11	19	21	109
115	117	8	8	29	90	56
125	5	11	13	13	11	2
135	0	3	3	3	0	1
145	5	5	11	5	0	4
155	0	3	5	5	0	2
165	5	3	8	5	0	1
175	0	5	3	3	0	0
180	6	6	6	6	6	

TOTAL LUMINAIRE EFFICIENCY = 58.2%
CIE Type – Direct

Spacing Criteria

Plane	Criteria
0°	1.8
90°	1.5
180°	1.1

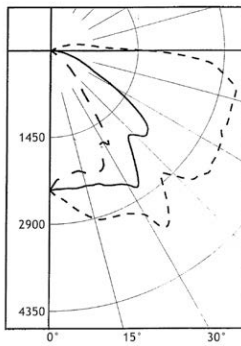

ZONAL LUMEN SUMMARY

ZONE	LUMENS	%LAMP	%FIXT.
0-30	2085	11.9	20.5
0-40	3597	20.6	35.3
0-60	6557	37.5	64.4
0-90	9755	55.7	95.8
90-120	412	2.4	4.1
90-130	415	2.4	4.1
90-150	420	2.4	4.1
90-180	423	2.4	4.2
0-180	10178	58.2	100.0

REPORT NUMBER: **KPB175PG3_AN**

Lamps: 175 W Pulse Start Metal Halide ED28 Mogul Base with G3 Globe and 30° Angle Dome Reflector

COEFFICIENTS OF UTILIZATION – ZONAL CAVITY METHOD

EFFECTIVE FLOOR CAVITY REFLECTANCE 0.20

RC	80			70			50			30			10			0		
	RW	70	50	30	10	70	50	30	10	50	30	10	50	30	10			
0	69	69	69	69	67	67	67	63	63	63	60	60	60	57	57	57	56	
1	61	57	54	51	59	56	53	50	53	50	48	50	48	46	48	46	45	43
2	55	49	44	40	53	48	43	40	45	42	38	43	40	37	41	38	36	34
3	49	42	37	33	48	41	36	32	39	35	31	37	34	31	35	32	30	28
4	45	37	32	27	43	36	31	27	34	30	26	33	29	26	31	28	25	24
5	41	33	27	23	40	32	27	23	31	26	22	29	25	22	28	24	21	20
6	38	30	24	20	37	29	24	20	28	23	19	26	22	19	25	22	19	17
7	35	27	21	18	34	26	21	17	25	20	17	24	20	17	23	19	16	15
8	33	24	19	16	32	24	19	15	23	18	15	22	18	15	21	17	15	13
9	30	22	17	14	29	22	17	14	21	17	14	20	16	13	19	16	13	12
10	28	20	16	12	28	20	15	12	19	15	12	19	15	12	18	14	12	11

Mercmaster™ III HID 50–250 Watt Luminaires

100 W HPS

* Photometric data is based on fixtures with a 100-watt clear High Pressure Sodium lamp (9,400 lumen). For candlepower values of fixtures with other HPS lamps, use the following multipliers: for a 70 W (6,400 lumen) HPS lamp – 0.68; for 50 W (4,000 lumen) HPS lamp – 0.43; for candlepower values of fixture with guard, multiply by 0.95.

CEC:
Class I, Division 2, Groups A, B, C, D
Class I, Zone 2 Ex nR IIC (Z)
Class II, Division 1 and 2, Groups E, F, G
Class III

CEC:
Type 4X
IP66

Photometric Data

Degree	Candela	Lumens
0	269	
5	267	27
15	407	117
25	571	267
35	748	442
45	451	380
55	848	735
65	915	908
75	976	1033
85	1021	1113
90	1027	
95	1019	1109
105	953	1002
115	791	734
125	54	103
135	13	9
145	13	8
155	4	2
165	0	0
175	0	0
180	1	

TOTAL LUMINAIRE EFFICIENCY = 84.1%
CIE Type – Semi-Direct
Spacing Criteria: 3.1

ZONAL LUMEN SUMMARY

ZONE	LUMENS	%LAMP	%FIXT.
0-30	410	4.3	5.1
0-40	852	9.0	10.7
0-60	1967	20.7	24.6
0-90	5021	52.9	62.9
90-120	2845	29.9	35.6
90-130	2948	31.0	36.9
90-150	2965	31.2	37.1
90-180	2967	31.2	37.1
0-180	7988	84.1	100.0

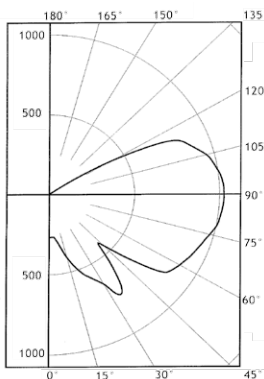

REPORT NUMBER: **KPB100LG3**
Lamps: 100 W High Pressure Sodium C100S54 ED23 – 1/2 Mogul Base with G3 Globe only

COEFFICIENTS OF UTILIZATION – ZONAL CAVITY METHOD
EFFECTIVE FLOOR CAVITY REFLECTANCE 0.20

RC	80			70			50			30			10			0		
	RW	70	50	30	10	70	50	30	10	50	30	10	50	30	10			
0	93	93	93	93	87	87	87	87	76	76	76	66	66	66	57	57	57	53
1	79	72	67	62	73	67	62	58	58	54	50	49	46	43	41	39	36	32
2	69	60	52	46	64	56	49	43	48	42	37	40	36	32	33	30	26	23
3	62	51	43	36	57	47	40	34	40	34	29	34	29	24	28	24	20	17
4	56	44	36	29	51	41	33	27	35	28	23	29	24	20	24	19	16	13
5	51	39	30	24	47	36	28	22	30	24	19	25	20	16	21	17	13	10
6	47	34	26	20	43	32	24	19	27	21	16	23	17	13	19	14	11	8
7	43	31	23	17	40	28	21	16	24	18	14	20	15	13	17	13	9	7
8	40	28	20	15	37	26	19	14	22	16	12	19	14	10	15	11	8	6
9	37	25	18	13	34	23	17	12	20	14	10	17	12	9	14	10	7	5
10	34	23	16	11	32	21	15	11	18	13	9	16	11	8	13	9	6	5

Degree	Candela	Lumens
0	1466	
5	1473	142
15	1607	456
25	1675	775
35	1757	1071
45	1316	1047
55	1502	1316
65	1377	1362
75	465	589
85	92	111
90	16	
95	3	5
105	6	6
115	40	33
125	5	8
135	3	2
145	3	1
155	2	1
165	0	1
175	1	0
180	1	

TOTAL LUMINAIRE EFFICIENCY = 72.9%
CIE Type – Direct
Spacing Criteria: 1.6

ZONAL LUMEN SUMMARY

ZONE	LUMENS	%LAMP	%FIXT.
0-30	1373	14.5	19.8
0-40	2445	25.7	35.3
0-60	4807	50.6	69.4
0-90	6869	72.3	99.2
90-120	45	0.5	0.6
90-130	53	0.6	0.8
90-150	56	0.6	0.8
90-180	58	0.6	0.8
0-180	6927	72.9	100.0

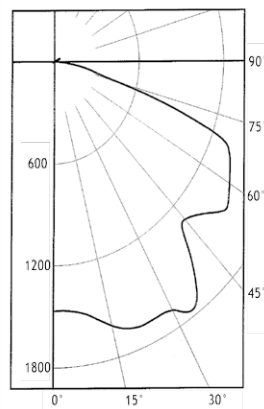

REPORT NUMBER: **KPB100LG3 ST**
Lamps: 100 W High Pressure Sodium C100S54 ED23 – 1/2 Mogul Base with G3 Globe and Standard Dome Reflector

COEFFICIENTS OF UTILIZATION – ZONAL CAVITY METHOD
EFFECTIVE FLOOR CAVITY REFLECTANCE 0.20

RC	80			70			50			30			10			0		
	RW	70	50	30	10	70	50	30	10	50	30	10	50	30	10			
0	87	87	87	87	85	85	85	85	81	81	81	77	77	77	74	74	74	72
1	78	74	71	68	76	73	70	67	70	67	65	67	64	62	64	62	60	59
2	70	64	58	53	68	62	57	53	59	55	51	57	53	50	54	52	49	47
3	63	55	48	43	61	54	47	43	51	46	42	49	45	41	47	43	40	38
4	57	48	41	35	55	47	40	35	45	39	34	43	38	34	41	37	33	32
5	52	42	35	30	51	41	34	29	39	34	29	38	33	29	36	32	28	26
6	48	37	30	25	46	37	30	25	35	29	25	34	29	25	33	28	24	23
7	44	34	27	22	43	33	26	22	32	26	22	31	25	21	29	25	21	20
8	41	30	24	19	40	30	24	19	29	23	19	28	23	19	27	22	19	17
9	38	23	21	17	37	27	21	17	26	21	17	25	20	17	25	20	17	15
10	36	25	19	15	35	25	19	15	24	19	15	23	19	15	23	18	15	14

Candela Distribution

	0.0	45.0	90.0	135.0	180.0	Flux
0	1270	1270	1270	1270	1270	
5	1317	1302	1271	1227	1211	122
15	1554	1471	1384	1341	1298	398
25	1779	1680	1528	1353	1246	694
35	1923	1830	1593	1256	1020	917
45	1715	1564	1163	599	361	848
55	1981	1862	1100	287	122	953
65	1923	1751	869	104	0	869
75	1879	1272	298	9	0	711
85	1371	828	140	1	0	424
90	680	422	89	2	1	
95	416	259	47	4	4	144
105	191	93	4	7	6	59
115	40	18	51	54	92	31
125	1	3	3	3	1	2
135	1	2	3	2	1	1
145	0	1	2	0	0	1
155	0	1	2	1	0	1
165	0	1	1	1	0	0
175	2	2	2	1	0	0
180	2	2	2	2	2	

TOTAL LUMINAIRE EFFICIENCY = 65.0%
CIE Type – Direct

Plane	Spacing Criteria
0°	1.9
90°	1.7
180°	1.3

ZONAL LUMEN SUMMARY

ZONE	LUMENS	%LAMP	%FIXT.
0-30	1213	12.8	19.7
0-40	2131	22.4	34.5
0-60	3932	41.4	63.7
0-90	5936	62.5	96.1
90-120	234	2.5	3.8
90-130	236	2.5	3.8
90-150	238	2.5	3.9
90-180	239	2.5	3.9
0-180	6175	65.0	100.0

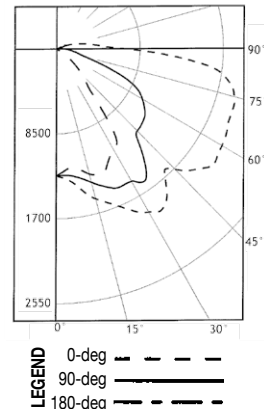

REPORT NUMBER: **KPB100LG3 AN**
Lamps: 100 W High Pressure Sodium C100S54 ED23 – 1/2 Mogul Base with G3 Globe and 30° Angle Reflector

COEFFICIENTS OF UTILIZATION – ZONAL CAVITY METHOD
EFFECTIVE FLOOR CAVITY REFLECTANCE 0.20

RC	80			70			50			30			10			0		
	RW	70	50	30	10	70	50	30	10	50	30	10	50	30	10			
0	77	77	77	77	75	75	75	75	71	71	71	67	67	67	64	64	64	62
1	68	64	61	57	66	62	59	56	59	56	54	56	54	52	53	51	50	48
2	61	55	49	45	59	53	48	44	50	46	43	48	44	41	45	42	40	38
3	55	47	41	36	53	46	40	36	44	39	35	41	37	34	39	36	33	31
4	50	41	35	30	48	40	34	30	38	33	29	36	32	28	35	31	28	26
5	46	37	30	25	44	36	30	25	34	29	25	32	28	24	31	27	24	22
6	42	33	26	22	41	32	26	22	30	25	21	29	24	21	28	24	20	19
7	39	30	23	19	38	29	23	19	28	22	19	26	22	18	25	21	18	17
8	36	27	21	17	35	26	21	17	25	20	16	24	20	16	23	19	16	15
9	34	25	19	15	33	24	19	15	23	18	15	22	18	14	21	17	14	13
10	32	23	17	14	31	22	17	13	21	17	13	20	16	13	20	16	13	12

Mercmaster™ III HID 50–250 Watt Luminaires

150 W HPS

* Photometric data is based on fixtures with a 150-watt clear High Pressure Sodium lamp (16,000 lumen). For candlepower values of fixtures with other HPS lamps, use the following multipliers: for a 70 W (6,400 lumen) HPS lamp – 0.40; for a 50 W (4,000 lumen) HPS lamp – 0.25. For candlepower values of fixture with guard, multiply by 0.95.

CEC:
Class I, Division 2, Groups A, B, C, D
Class I, Zone 2 Ex nR IIC (Z)
Class II, Division 1 and 2, Groups E, F, G
Class III

CEC:
Type 4X
IP66

Photometric Data

Degree	Candela	Lumens
0	488	
5	459	46
15	703	202
25	938	442
35	1107	672
45	892	710
55	1420	1253
65	1542	1529
75	1629	1723
85	1675	1824
90	1665	
95	1643	1788
105	1515	1599
115	1072	1042
125	51	115
135	20	16
145	19	12
155	6	4
165	1	0
175	0	0
180	2	

TOTAL LUMINAIRE EFFICIENCY = 81.1%
CIE Type – Semi-Direct
Spacing Criteria: 3.0

ZONAL LUMEN SUMMARY			
ZONE	LUMENS	%LAMP	%FIXT.
0-30	689	4.3	5.3
0-40	1361	8.5	10.5
0-60	3324	20.8	25.6
0-90	8400	52.5	64.7
90-120	4429	27.7	34.1
90-130	4544	28.4	35.0
90-150	4572	28.6	35.2
90-180	4576	28.6	35.3
0-180	12976	81.1	100.0

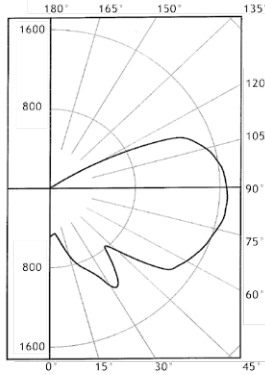

REPORT NUMBER: KP150LG3
Lamps: 150 W High Pressure Sodium C100S54 ED23 – 1/2 Mogul Base with G3 Globe only

COEFFICIENTS OF UTILIZATION – ZONAL CAVITY METHOD															
EFFECTIVE FLOOR CAVITY REFLECTANCE 0.20															
RC	80				70				50				0		
RW	70	50	30	10	70	50	30	10	50	30	10	50	30	10	0
0	90	90	90	90	84	84	84	84	74	74	74	65	65	65	56
1	76	70	65	60	71	65	60	56	56	53	49	48	45	42	41
2	67	58	51	44	62	54	47	42	46	41	36	39	35	31	33
3	60	49	41	34	55	46	38	32	39	33	28	33	28	24	27
4	54	43	34	29	50	40	32	26	34	27	22	28	23	19	23
5	49	37	29	23	45	35	27	21	30	23	18	25	20	16	21
6	45	33	25	19	42	31	23	18	26	20	15	22	17	13	18
7	41	30	22	16	38	27	20	15	24	18	13	20	15	11	16
8	38	27	19	14	35	25	18	13	21	16	11	18	13	10	15
9	36	24	17	12	33	23	16	12	19	14	10	17	12	8	14
10	33	22	15	11	31	21	14	10	18	12	9	15	11	7	13

Appleton

Degree	Candela	Lumens
0	2403	
5	2391	230
15	2624	744
25	2678	1247
35	2705	1673
45	2250	1754
55	2444	2161
65	2246	2192
75	655	851
85	147	174
90	26	
95	6	8
105	11	13
115	73	71
125	7	12
135	6	3
145	4	2
155	4	2
165	2	1
175	2	0
180	1	

TOTAL LUMINAIRE EFFICIENCY = 69.6%
CIE Type – Direct
Spacing Criteria: 1.6

ZONAL LUMEN SUMMARY			
ZONE	LUMENS	%LAMP	%FIXT.
0-30	2221	13.9	19.9
0-40	3895	24.3	35.0
0-60	7809	48.8	70.1
0-90	11027	68.9	99.0
90-120	92	0.6	0.8
90-130	104	0.6	0.9
90-150	109	0.7	1.0
90-180	112	0.7	1.0
0-180	11139	69.6	100.0

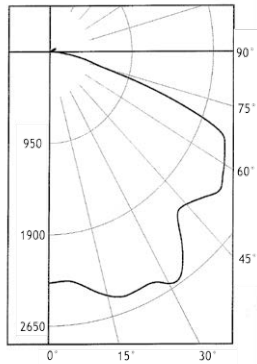

REPORT NUMBER: KP150LG3_ST
Lamps: 150 W High Pressure Sodium C100S54 ED23 – 1/2 Mogul Base with G3 Globe and Standard Dome Reflector

COEFFICIENTS OF UTILIZATION – ZONAL CAVITY METHOD															
EFFECTIVE FLOOR CAVITY REFLECTANCE 0.20															
RC	80				70				50				0		
RW	70	50	30	10	70	50	30	10	50	30	10	50	30	10	0
0	83	83	83	83	81	81	81	81	77	77	77	74	74	74	70
1	75	71	68	65	73	70	67	64	66	64	62	64	62	60	61
2	67	61	56	51	65	60	55	51	57	53	49	54	51	48	52
3	61	52	46	41	59	51	46	41	49	44	40	47	43	39	45
4	55	46	39	34	53	45	38	34	43	37	33	41	36	33	39
5	50	40	33	28	48	39	33	28	38	32	28	36	31	27	35
6	46	36	29	24	44	35	29	24	34	28	24	32	27	24	31
7	42	32	26	21	41	32	25	21	30	25	21	29	24	20	28
8	39	29	23	18	38	29	23	18	28	22	18	27	22	18	26
9	36	27	20	16	35	26	20	16	25	20	16	24	20	16	24
10	34	24	19	15	33	24	18	15	23	18	14	22	18	14	22

HID/AREA: NEC/CEC ENCLOSED AND GASKETED

Candela Distribution					
0.0	45.0	90.0	135.0	180.0	Flux
0	1964	1964	1964	1964	1964
5	2035	2007	1941	1871	1838
15	2375	2307	2140	2047	2037
25	2755	2587	2288	2095	1853
35	2924	2763	2415	1885	1276
45	2790	2552	2015	780	518
55	3166	2937	1945	410	157
65	3188	2913	777	77	0
75	3145	2547	408	1	2
85	2533	927	117	0	2
90	1490	640	14	5	9
95	765	449	5	8	11
105	380	163	6	11	15
115	114	4	6	18	63
125	2	5	7	8	7
135	2	6	7	8	6
145	0	2	6	4	2
155	2	4	6	4	2
165	4	3	5	4	2
175	0	2	3	3	2
180	2	2	2	2	2

TOTAL LUMINAIRE EFFICIENCY = 61.0%
CIE Type – Direct
Spacing Criteria: 1.3

ZONAL LUMEN SUMMARY			
ZONE	LUMENS	%LAMP	%FIXT.
0-30	1886	11.8	19.3
0-40	3302	20.6	33.8
0-60	6190	38.7	63.5
0-90	9351	58.4	95.9
90-120	389	2.4	4.0
90-130	395	2.5	4.0
90-150	401	2.5	4.1
90-180	404	2.5	4.1
0-180	9754	61.0	100.0

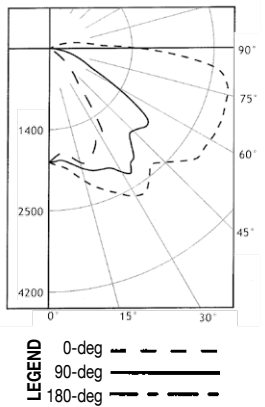

REPORT NUMBER: KP150LG3_AN
Lamps: 150 W High Pressure Sodium C100S54 ED23 – 1/2 Mogul Base with G3 Globe and 30° Angle Reflector

COEFFICIENTS OF UTILIZATION – ZONAL CAVITY METHOD															
EFFECTIVE FLOOR CAVITY REFLECTANCE 0.20															
RC	80				70				50				0		
RW	70	50	30	10	70	50	30	10	50	30	10	50	30	10	0
0	72	72	72	72	70	70	70	70	66	66	66	63	63	63	60
1	64	60	57	54	62	58	55	53	55	53	50	52	50	48	50
2	57	51	46	42	55	50	45	41	47	43	40	45	41	39	42
3	52	44	38	34	50	43	38	33	41	36	33	39	35	32	37
4	47	39	33	28	45	38	32	28	36	31	27	34	30	26	32
5	43	34	28	24	41	33	28	24	32	27	23	30	26	22	29
6	39	31	25	20	38	30	24	20	28	24	20	27	23	19	26
7	36	28	22	18	35	27	22	18	26	21	17	25	20	17	24
8	34	25	20	16	33	24	19	16	23	19	15	22	18	15	22
9	32	23	18	14	30	22	17	14	21	17	14	21	16	13	20
10	30	21	16	13	29	21	16	12	20	15	12	19	15	12	18

Mercmaster™ III HID 50–250 Watt Luminaires

250 W PSMH

* Photometric data is based on fixtures with a 250-watt clear Pulse Start Metal Halide lamp (23,000 lumen). For candlepower values of fixtures with other PSMH lamps, (21,000 lumen) PSMH lamp – 0.913. For candlepower values of fixture with guard, multiply by 0.95.

CEC:
 Class I, Division 2, Groups A, B, C, D
 Class I, Zone 2 Ex nR IIC (Z)
 Class II, Division 1 and 2, Groups E, F, G
 Class III

CEC:
 Type 4X
 IP66

Photometric Data

Zone	Lumens
0-10	307.05
10-20	986.27
20-30	1556.63
30-40	2215.28
40-50	2539.71
50-60	2525.66
60-70	2313.2
70-80	1992.57
80-90	1470.76
90-100	689.06
100-110	177.72
110-120	46
120-130	10.39
130-140	6.24
140-150	5.71
150-160	3.95
160-170	2.26
170-180	.8

TOTAL LUMINAIRE EFFICIENCY = 67.4%
 CIE Type – Direct
 Spacing Criteria: 2.16

ZONAL LUMEN SUMMARY			
ZONE	LUMENS	%LAMP	%FIXT.
0-30	2849.95	11.4	16.9
0-40	5065.22	20.3	30.1
0-60	10130.59	40.5	60.1
0-90	15907	63.6	94.4
90-120	912.78	3.7	5.4
90-130	923.17	3.7	5.5
90-150	935.11	3.7	5.5
90-180	942.12	3.8	5.6
0-180	16849.24	67.4	100.0

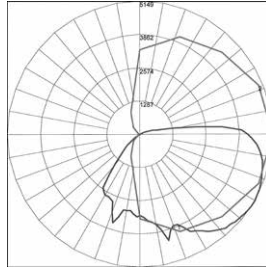

REPORT NUMBER: KPBG250PAN
 Lamps: 250 W Metal Halide Pulse Start
 Mogul Base

COEFFICIENTS OF UTILIZATION – ZONAL CAVITY METHOD

EFFECTIVE FLOOR CAVITY REFLECTANCE 0.20

RC	80			70			50			30			10			0		
	70	50	30	10	70	50	30	10	50	30	10	50	30	10	0			
0	79	79	79	79	77	77	77	77	73	73	73	69	69	69	65	65	65	64
1	70	65	62	58	67	63	60	57	60	57	54	56	54	52	53	51	50	48
2	62	55	50	45	60	54	49	44	51	46	43	48	44	41	45	42	39	38
3	56	48	41	36	54	46	40	36	44	39	34	41	37	33	39	35	32	30
4	51	42	35	30	49	41	34	29	38	33	29	36	31	28	34	30	27	25
5	47	37	30	25	45	36	30	25	34	28	24	32	27	23	30	26	23	21
6	43	33	26	21	41	32	26	21	30	25	21	29	24	20	27	23	20	18
7	40	30	23	19	38	29	23	18	27	22	18	26	21	18	25	20	17	16
8	37	27	21	16	35	26	20	16	25	20	16	24	19	16	23	18	15	14
9	34	24	19	15	33	24	18	14	23	18	14	22	17	14	21	17	14	12
10	32	22	17	13	31	22	17	13	21	16	13	20	16	12	19	15	12	11

Zone	Lumens
0-10	382.83
10-20	1200.76
20-30	1987.77
30-40	2662.58
40-50	3136.15
50-60	3436.26
60-70	3412.32
70-80	1660.08
80-90	278.17
90-100	3.43
100-110	0
110-120	0
120-130	0
130-140	0
140-150	0
150-160	0
160-170	0
170-180	0

TOTAL LUMINAIRE EFFICIENCY = 72.6%
 CIE Type – Direct
 Spacing Criteria: 1.58

ZONAL LUMEN SUMMARY			
ZONE	LUMENS	%LAMP	%FIXT.
0-30	3571.36	14.3	19.7
0-40	6233.94	24.9	34.3
0-60	12806.35	51.2	70.5
0-90	18156.91	72.6	100
90-120	3.43	0	0
90-130	3.43	0	0
90-150	3.43	0	0
90-180	3.43	0	0
0-180	18160.34	72.6	100.0

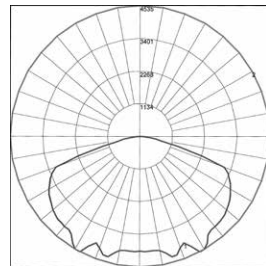

REPORT NUMBER: KPBG250PST
 Lamps: 250 W Metal Halide Pulse Start
 Mogul Base

COEFFICIENTS OF UTILIZATION – ZONAL CAVITY METHOD

EFFECTIVE FLOOR CAVITY REFLECTANCE 0.20

RC	80			70			50			30			10			0		
	70	50	30	10	70	50	30	10	50	30	10	50	30	10	0			
0	86	86	86	86	84	84	84	84	81	81	81	77	77	77	74	74	74	73
1	78	74	71	68	76	73	70	67	70	67	65	67	65	63	64	62	61	59
2	70	63	58	53	68	62	57	53	59	55	51	57	53	50	55	52	49	47
3	63	55	48	43	61	53	47	42	51	46	42	49	45	41	47	43	40	38
4	57	48	41	35	55	47	40	35	45	39	34	43	38	34	41	37	33	32
5	52	42	35	30	50	41	34	29	39	34	29	38	33	29	37	32	28	27
6	48	37	30	25	46	37	30	25	35	29	25	34	29	25	33	28	24	23
7	44	33	27	22	43	33	26	22	32	26	22	31	25	21	30	25	21	20
8	41	30	24	19	40	30	23	19	29	23	19	28	23	19	27	22	19	17
9	38	28	21	17	37	27	21	17	26	21	17	25	20	17	25	20	17	15
10	35	25	19	15	35	25	19	15	24	19	15	23	18	15	23	18	15	14

Candela Distribution	
Zone	
0-10	74.54
10-20	304.58
20-30	486.47
30-40	948.61
40-50	1471.61
50-60	1887.31
60-70	2239.17
70-80	2561.7
80-90	2747.67
90-100	2779.02
100-110	2564.95
110-120	2148.15
120-130	1109.49
130-140	37.55
140-150	3.93
150-160	.76
160-170	.09
170-180	.03

TOTAL LUMINAIRE EFFICIENCY = 85.5%
 CIE Type – General Diffuse

ZONAL LUMEN SUMMARY			
ZONE	LUMENS	%LAMP	%FIXT.
0-30	865.59	3.5	4.1
0-40	1814.2	7.3	8.5
0-60	5173.13	20.7	24.2
0-90	12721.67	50.9	59.5
90-120	7492.124	30	35.1
90-130	8601.61	34.4	40.3
90-150	8643.09	34.6	40.5
90-180	8643.97	34.6	40.5
0-180	21365.63	85.5	100.0

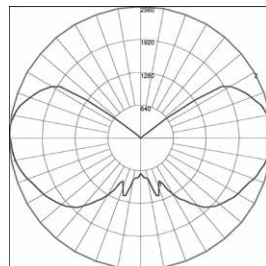

REPORT NUMBER: KPBG250PG
 Lamps: 250 W Metal Halide Pulse Start
 Mogul Base

COEFFICIENTS OF UTILIZATION – ZONAL CAVITY METHOD

EFFECTIVE FLOOR CAVITY REFLECTANCE 0.20

RC	80			70			50			30			10			0		
	70	50	30	10	70	50	30	10	50	30	10	50	30	10	0			
0	94	94	94	94	87	87	87	87	76	76	76	65	65	65	55	55	55	51
1	80	74	68	63	74	68	63	59	58	54	51	49	46	43	40	38	36	31
2	71	61	54	47	65	57	50	44	48	42	38	40	36	32	32	29	26	22
3	63	52	44	37	58	48	41	34	41	34	29	33	29	25	27	23	20	16
4	57	45	36	30	52	42	34	28	35	29	24	29	24	20	23	19	16	13
5	52	40	31	25	47	36	29	23	31	24	19	25	20	16	20	16	13	10
6	47	35	27	21	43	32	25	19	27	21	16	22	17	13	18	14	11	8
7	44	31	23	18	40	29	22	16	24	18	14	20	15	11	16	12	9	7
8	40	28	20	15	37	26	19	14	22	16	12	18	13	10	15	11	8	6
9	37	25	18	13	34	24	17	12	20	14	10	17	12	9	13	10	7	5
10	35	23	16	12	32	22	15	11	18	13	9	15	11	8	12	9	6	4

Mercmaster™ III HID 50–250 Watt Luminaires

250 W PSMH

* Photometric data is based on fixtures with a 250-watt clear Pulse Start Metal Halide lamp (23,000 lumen). For candlepower values of fixtures with other PSMH lamps, (21,000 lumen) PSMH lamp – 0.913. For candlepower values of fixture with guard, multiply by 0.95.

CEC:
 Class I, Division 2, Groups A, B, C, D
 Class I, Zone 2 Ex nR IIC (Z)
 Class II, Division 1 and 2, Groups E, F, G
 Class III

CEC:
 Type 4X
 IP66

Photometric Data

Zone	Lumens	TOTAL LUMINAIRE EFFICIENCY = 79%	
0-10	28.46	CIE Type – Semi-Direct	
10-20	222.99	Spacing Criteria: 1.64	
20-30	438.39		
30-40	727.7		
40-50	1709.75		
50-60	2094.28		
60-70	4828.69		
70-80	4189.12		
80-90	2131.34		
90-100	748.43		
100-110	1109.54		
110-120	701.88		
120-130	410.51		
130-140	237.73		
140-150	123.53		
150-160	37.79		
160-170	3.51		
170-180	.32		

ZONAL LUMEN SUMMARY			
ZONE	LUMENS	%LAMP	%FIXT.
0-30	689.84	2.8	3.5
0-40	1417.54	5.7	7.2
0-60	5221.56	20.9	26.4
0-90	16370.71	65.5	82.9
90-120	2559.84	10.2	13
90-130	2970.35	11.9	15
90-150	3331.61	13.3	16.9
90-180	3373.23	13.5	17.1
0-180	19743.94	79	100.0

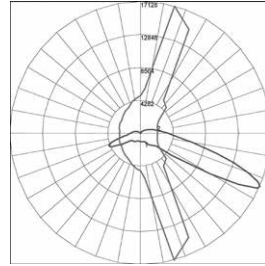

REPORT NUMBER: **KPBR250PJ3**
 Lamps: 250 W Metal Halide Pulse Start
 Mogul Base

COEFFICIENTS OF UTILIZATION – ZONAL CAVITY METHOD
 EFFECTIVE FLOOR CAVITY REFLECTANCE 0.20

RC	80				70				50				30				10				0
	RW	70	50	30	10	70	50	30	10	50	30	10	50	30	10	50	30	10	0		
0	91	91	91	91	87	87	87	87	80	80	80	74	74	74	68	68	68	65			
1	77	70	65	60	73	67	62	57	61	57	53	55	52	49	50	48	45	42			
2	66	56	48	42	62	54	46	40	48	42	37	43	38	34	39	35	31	28			
3	58	46	37	30	55	44	36	29	39	32	27	35	29	24	31	26	22	19			
4	52	39	30	23	49	37	29	22	33	26	20	30	23	18	26	21	17	14			
5	47	34	25	18	44	32	24	17	29	21	16	25	19	14	22	17	13	10			
6	43	30	21	15	40	28	20	14	25	18	13	22	16	12	20	14	10	8			
7	39	26	18	12	37	25	17	12	22	16	11	20	14	9	18	12	8	6			
8	36	24	16	10	34	22	15	10	20	14	9	18	12	8	16	11	7	5			
9	33	21	14	9	32	20	13	8	18	12	8	16	11	7	15	10	6	4			
10	31	19	12	8	29	18	12	7	17	11	7	15	10	6	13	9	5	4			

Zone	Lumens	TOTAL LUMINAIRE EFFICIENCY = 84%	
0-10	28.96	CIE Type – Semi-Direct	
10-20	214.01	Spacing Criteria: 1.64	
20-30	402.91		
30-40	678.83		
40-50	1539.03		
50-60	1537.39		
60-70	4450.44		
70-80	5789.28		
80-90	3160.26		
90-100	855.15		
100-110	1095.13		
110-120	596.59		
120-130	345.11		
130-140	189.6		
140-150	82.84		
150-160	22.91		
160-170	2.78		
170-180	.71		

ZONAL LUMEN SUMMARY			
ZONE	LUMENS	%LAMP	%FIXT.
0-30	645.89	2.6	3.1
0-40	1324.72	5.3	6.3
0-60	4401.15	17.6	21
0-90	17801.14	71.2	84.8
90-120	2546.87	10.2	12.1
90-130	2891.98	11.6	13.8
90-150	3164.41	12.7	15.1
90-180	3190.80	12.8	15.2
0-180	20991.94	84	100.0

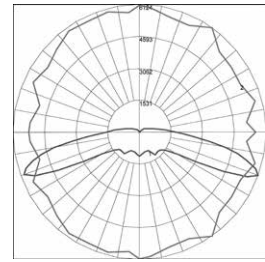

REPORT NUMBER: **KPBR250PJ5**
 Lamps: 250 W Metal Halide Pulse Start
 Mogul Base

COEFFICIENTS OF UTILIZATION – ZONAL CAVITY METHOD
 EFFECTIVE FLOOR CAVITY REFLECTANCE 0.20

RC	80				70				50				30				10				0
	RW	70	50	30	10	70	50	30	10	50	30	10	50	30	10	50	30	10	0		
0	97	97	97	97	93	93	93	93	86	86	86	80	80	80	74	74	74	71			
1	80	72	66	60	76	69	63	57	63	58	53	57	53	49	52	48	45	42			
2	68	57	48	40	65	54	46	38	49	42	35	44	38	33	39	34	30	27			
3	60	47	37	29	56	44	35	27	40	32	25	35	29	23	31	26	21	18			
4	54	40	29	22	50	37	28	21	33	25	19	30	23	17	26	20	15	13			
5	48	34	24	17	45	32	23	16	29	21	15	26	19	13	23	17	12	9			
6	44	30	21	14	41	28	20	13	25	18	12	23	16	11	20	14	10	7			
7	41	27	18	11	38	25	17	11	23	15	10	20	14	9	18	12	8	6			
8	38	24	16	10	35	23	15	9	21	14	8	18	12	8	16	11	7	5			
9	35	22	14	8	33	21	13	8	19	12	7	17	11	7	15	10	6	4			
10	33	20	12	7	31	19	12	7	17	11	6	16	10	6	14	9	5	3			

Appleton

HID/AREA: NEC/CEC ENCLOSED AND GASKETED

Mercmaster™ III 400 Luminaire for Hazardous and Wet Locations

High Pressure Sodium and Pulse Start Metal Halide

Listed for simultaneous exposure to combustible dusts and flammable gases or vapors.

NEC/CEC:

Class I, Division 2, Groups A, B, C, D
Class I, Zone 2, AEx nA nR IIC (Z2)
Class I, Zone 2, AEx nR IIC (ZB)
Class II, Division 1 and 2, Groups E, F, G
Class III

NEC/CEC:

Simultaneous Exposure (Class I, Division 2/
Class II, Division 1)
Fixtures Outside Type (Salt Water)
Type 4X
IP66

Applications

- Enclosed and gasketed fixtures suitable for use in:
 - Marine and wet locations
 - A wide range of industrial, chemical processing and other areas where flammable gases and vapors or combustible dusts are present under conditions defined by the National Electrical Code as Class I, Division 2; Class II, Division 1 and 2; and Class III
 - In applications involving medium and high mounting heights
 - In applications where energy efficient, high lumen output is required
 - The AEx nA nR Mercmaster III fixture is factory sealed and prevents vapors and gases from entering the globe chamber. There are no seals or putty required.
 - The AEx nR Mercmaster III fixture requires all wiring entries to be sealed.
 - Non-hazardous locations where severe weather conditions, excessive moisture, dirt, dust, corrosive atmosphere or high ambient temperatures are encountered
- Typical applications include:
 - Pulp and paper mills
 - Processing plants
 - Chemical plants
 - Oil refineries
 - Foundries
 - Manufacturing plants
 - Storage areas
 - Waste and sewage treatment
 - Other areas where dust, water, dirt and rough usage are a problem

Features

- Superior corrosion resistance.
- Choice of light sources: high pressure sodium, and pulse start metal halide.
- Six mounting arrangements to suit any lighting layout: pendant, ceiling, wall bracket, 25° (angle) stanchion, 90° (straight) stanchion and cone.
- Hinge has high lip for added safety during installation and servicing. Hinge and bolt construction assures 360° compression at all points on ballast housing gasket for positive sealing. Swing away design of captive bolt and nut simplifies servicing.
- Choice of optical assemblies: prismatic globe; enclosed reflector with sealed lens; or Type V or Type II closed prismatic glass refractor, with or without guards.
- Wide choice of photometric distributions.
- All fixtures designed to perform in a 40 °C (104 °F) ambient temperature. Selected fixtures are suitable for ambient temperatures up to 65 °C (149 °F) .
- Mogul base porcelain lamp holder with nickel-plated contacts has 200 °C (392 °F) rated welded leads, pre-wired to the ballast. Assures trouble-free operation in installations where high ambient temperatures are encountered.
- For electrical protection, a ground wire is provided on each Mercmaster to bond hood and ballast housing.
- Terminal blocks are provided for Zone 2 fixtures to facilitate wiring.
- Standard dome of 30° angle reflectors made of fiberglass reinforced white polyester. Highly resistant to corrosive atmospheres.
- A wide range of voltages available (120 to 600 Volt) and ballast types (CWA and Super CWA).
- One-piece ballast housing for each component provides even



Enclosed Reflector

Prismatic Glass Globe

12" Glass Refractor

- heat dissipation for cooler operation and longer ballast life.
- All Mercmaster mounting hoods have provision for easy field installation of fuses in fixtures (see fuse kit listings).

Standard Materials

- Mounting hoods and ballast bodies: cast copperfree (less than 4/10 of 1% copper) aluminum
- Reflectors: Fiberglass reinforced white polyester
- Guards, hardware and catch assemblies: stainless steel
- Globe: heat- and impact-resistant internally fluted glass
- Refractors: prismatic glass
- Enclosed reflector: etched Alzak aluminum with sealed, tempered heat- and impact-resistant lens
- Body and globe gaskets: high-temperature silicone rubber

Standard Finishes

- Mounting hoods and guards: epoxy powder coat, electrostatically applied for complete and uniform protection

Options

- AEx nA nR fixtures are available with a Class I, Zone 2 rating. Add suffix **-Z2**.
- AEx nR fixtures are available with a Class I, Zone 2 rating. Add suffix **-ZB**.
- Quartz Auxiliary comes to full brightness immediately and remains lit until the HID lamp attains 60-70% of full illumination. Quartz Auxiliary supplied with relay switch and socket to accept 120 V quartz double-contact bayonet base lamp (not included). (Not suitable for hazardous locations.) Add suffix **-E**.
- Factory sealed photocontrol available. See PCD2 Series.
- Smart Starter incorporates a 1-1/2-minute timer and performs as a conventional starter to normally start lamp. Removes itself from circuit if lamp burns out or is removed from socket. Eliminates starter failures caused by prolonged operation with cycling or failing lamps and simplifies finding their location, reducing maintenance and repair costs. Available for all HPS and PSMH fixtures. Add suffix **-S**.

NEC/CEC Certifications and Compliances

- cULus Listed: E10444
- UL Standard: ANSI/UL 844, 1598, 60079-0, 60079-15, Marine Type Electric Fixtures Outside Type (Salt Water)
- CSA Certified: 025428
- CSA Standard: CSA C22.2 No. 9, C22.2 No. 137; CAN/CSA E60079-0, E60079-15
- 250 W PSMH not available in MT ballast. See Mercmaster III, 50-250 Luminaires.

Mercmaster™ III 400 Luminaire for Hazardous and Wet Locations

High Pressure Sodium and Pulse Start Metal Halide

Listed for simultaneous exposure to combustible dusts and flammable gases or vapors.

NEC/CEC:

Class I, Division 2, Groups A, B, C, D
Class I, Zone 2, AEx nA nR IIC (Z2)
Class I, Zone 2, AEx nR IIC (ZB)
Class II, Division 1 and 2, Groups E, F, G
Class III

NEC/CEC:

Simultaneous Exposure (Class I, Division 2/
Class II, Division 1)
Fixtures Outside Type (Salt Water)
Type 4X
IP66

Illustrated Features



High Temperature Sockets

Mogul base high-temperature porcelain sockets.

Aluminum Inner Reflector

Solid aluminum inner reflector (for refractor ballast housings only) improves photometric efficiency.

Globe Chamber

Completely sealed from the ballast housing and outside vapors/air (nR).



Vented Reflectors

Reflectors are thick, tough fiberglass-reinforced white polyester, vented for cooler operation. Quickly attach with furnished stainless steel screws.

Terminal Blocks (Zone 2)

A seven-point terminal block is provided to facilitate wiring. Terminal block accommodates wire size ranging from #8 to #24 AWG.

Stainless Steel Inserts

Ballast bodies have stainless steel threaded inserts to receive stainless steel screws for reflectors and guard. Prevents "freezing", allowing guards and reflectors to be easily removed and replaced at any time, without damage to the housing.



Ballast Assembly

Utilizing non-sparking components avoiding the ignition of gases or vapors that may be present (nA).

Mounting Hood and Globe Gaskets

Silicone rubber gasket seals out moisture, dirt and dust. Stays flexible, withstands high temperatures. Closure design assures uniform gasket compression.

Electrical Protection

Ground wire provided to bond mounting hood to ballast housing.



"Safety" High Hinge

Extra-high hinge provides additional protection against accidental ballast housing disengagement during installation or maintenance.

Epoxy Finish

Ballast housing, hoods and guards are copperfree aluminum with epoxy powder coat finish.

Photocell

Available for all fixtures except cone and ceiling mount. Installs through knock-out in mounting hood. Provides continuous ON-OFF dusk-to-dawn control.



Cooler Operating Cone Hood

Larger sloped surface sheds dusts, dirt and combustible fibers providing better heat dissipation.



Stainless Steel Latch Assembly

Captive, stainless steel latch assembly bolt and nut closes securely, resists attack of corrosive atmospheres. Swing-away design simplifies servicing.

Prismatic Glass Globes, Reflectors and Enclosed Reflector

Heat-resistant globes, reflectors and enclosed reflector thread into ballast housing and seal against a high temperature silicone rubber gasket.



Fuses

Two screws secure fuse kit to mounting boss in any Mercmaster mounting hood. Fuse included.

Mercmaster™ III 400 Luminaire for Hazardous and Wet Locations

High Pressure Sodium and Pulse Start Metal Halide

Listed for simultaneous exposure to combustible dusts and flammable gases or vapors.

NEC/CEC:

Class I, Division 2, Groups A, B, C, D
 Class I, Zone 2, AEx nA nR IIC (Z2)
 Class I, Zone 2, AEx nR IIC (ZB)
 Class II, Division 1 and 2, Groups E, F, G
 Class III

NEC/CEC:

Simultaneous Exposure (Class I, Division 2/
 Class II, Division 1)
 Fixtures Outside Type (Salt Water)
 Type 4X
 IP66

Mercmaster III 400 Family Tree

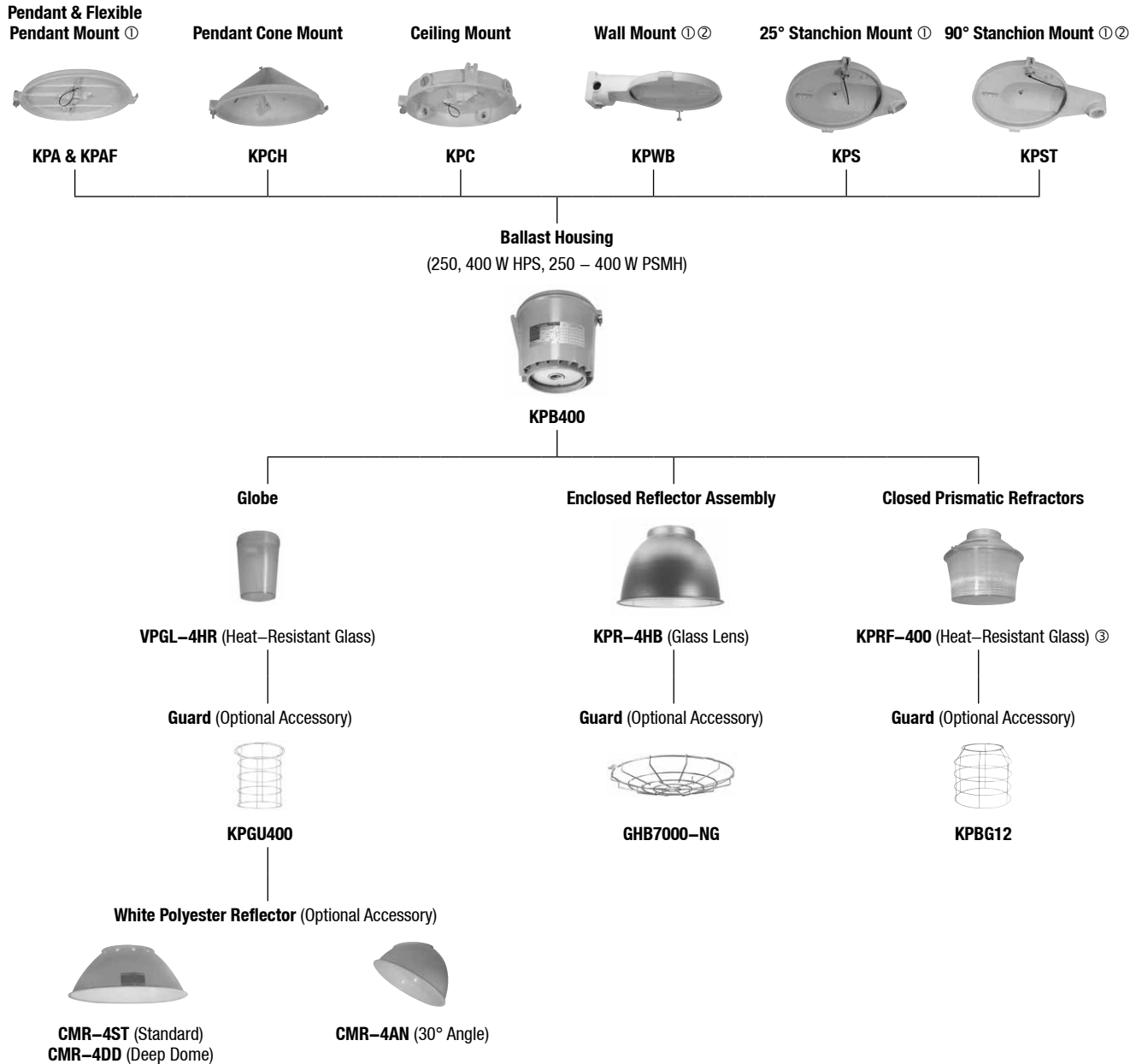

① Mounting hood with a 120 V or 208-277 V factory installed photocell is available.

② Standard and deep dome reflectors may interfere with bottom conduit entry if used with KPST and KPWB mounting hoods.

③ Available in NEMA Type II and V.

Mercmaster™ III 400 Luminaire for Hazardous and Wet Locations

High Pressure Sodium and Pulse Start Metal Halide

Listed for simultaneous exposure to combustible dusts and flammable gases or vapors.

NEC/CEC:

Class I, Division 2, Groups A, B, C, D
 Class I, Zone 2, AEx nA nR IIC (Z2)
 Class I, Zone 2, AEx nR IIC (ZB)
 Class II, Division 1 and 2, Groups E, F, G
 Class III

NEC/CEC:

Simultaneous Exposure (Class I, Division 2/
 Class II, Division 1)
 Fixtures Outside Type (Salt Water)
 Type 4X
 IP66

Order using catalog numbering guide below or select catalog number from tables on following pages.

Catalog Numbering Guide

<p>KP</p> <p>Series: KP - Mercmaster III 400</p>	<p>A</p> <p>Mounting: A - Pendant (rigid mounting) C - Ceiling CH - Pendant Cone Hood F - Pendant (flexible mounting) ST - 90° Stanchion S - 25° Stanchion WB - Wall</p>	<p>L</p> <p>Lamp Type: L - High Pressure Sodium P - Pulse Start Metal Halide</p>	<p>40</p> <p>Wattage: 25 - 250 W HPS, PSMH ⑤ 32 - 320 W PSMH 35 - 350 W PSMH 40 - 400 W PSMH & HPS</p>	<p>10</p> <p>Hub Size: 75 - 3/4" NPT 10 - 1" NPT 125 - 1-1/4" NPT stanchion 150 - 1-1/2" NPT stanchion</p>	<p>J5</p> <p>Optical Assembly: ① Blank - Glass Globe J2 - NEMA II Glass Refractor ④ J5 - NEMA V Glass Refractor ④ R - Enclosed Refractor with Sealed Lens</p>	<p>G</p> <p>Guard Options: ② G - Globe Guard BG - Refractor Guard Blank - No Guard</p>	<p>MT</p> <p>Voltage: ③ MT - 120/208/240/277, 60 Hz 5MT - 120/208/240/ 277/480, 60 Hz 48 - 480, 60 Hz 125 - 120, 50Hz 226 - 220, 60 Hz 235 - 230, 50Hz 245 - 240, 50 Hz</p>	<p>S</p> <p>Options: E - Emergency Quartz F - Fuse Kit (Specify Voltage) S - Smart Starter H1 - Photocontrol 120 V H2 - Photocontrol 208 V H3 - Photocontrol 240 V H4 - Photocontrol 277 V E40 - Export Socket</p> <p>Optional Fusing ⑥ FN - 120 V FP - 208 V FS - 240 V FT - 277 V FF - 480 V</p>	<p>Z2</p> <p>Suffix: Z2 - Zone 2 suffix (required for AEx nA nR rating) ZB - Zone 2 suffix (required for AEx nR rating)</p>
--	--	---	---	---	---	---	---	---	---

Refer to "Mounting Hoods and Ballast" page for available Voltage Configuration.

① NO DESIGNATION is required for fixtures with standard type globe.

② NO DESIGNATION is required for fixtures without guards.

③ Other voltages available. Contact your local sales representative.

④ J2 and J5 refractors are not available with Z2 or ZB suffix.

⑤ Available for 480 V, 50 Hz and 5MT ballast options. For MT and TT voltage suffix, see Mercmaster III 50-250 Luminaires.

⑥ Optional fusing is available for use with MT, 5MT and 48 voltage suffixes ONLY.

Mercmaster™ III 400 Luminaire for Hazardous and Wet Locations

Class I, Division 2; Class II, Division 1; Simultaneous Exposure to Hazardous Conditions on Both Classifications

Temperature identification numbers of Mercmaster III – 400 Fixtures.

NEC/CEC:

Class I, Division 2, Groups A, B, C, D
 Class I, Zone 2, AEx nA nR IIC (Z2)
 Class I, Zone 2, AEx nR IIC (ZB)
 Class II, Division 1 and 2, Groups E, F, G
 Class III

NEC/CEC:

Simultaneous Exposure (Class I, Division 2/
 Class II, Division 1)
 Fixtures Outside Type (Salt Water)
 Type 4X
 IP66

“T” Numbers

Lamp Watts	Supply Wire Temp. °C (°F) ①	Ambient Temp. °C (°F) ①	Class I, Division 2				Class II, Division 1 Groups E, F and G				Simultaneous Exposure Class I, Division 2 / Class II, Division 1				
			Globe	Globe & Reflector	Reflector	Enclosed Reflector	Globe	Globe & Reflector	Reflector	Enclosed Reflector	Globe	Globe & Reflector	Reflector	Enclosed Reflector	
250	HPS	125 °C (257 °F)	40 °C (104 °F)	T2	T2	T2	T2	T3B	T3B	T4	T4A	325	325	325	325
		125 °C (257 °F)	55 °C (131 °F)	325	325	T2	T2	—	—	T3B	T4A	—	—	T1	325
		125 °C (257 °F)	65 °C (149 °F)	—	—	T2	T2	—	—	T3B	T4	—	—	T1	350
400	HPS	90 °C (194 °F)	40 °C (104 °F)	350	T1	T1	350	T3 ②	T3 ②	T3C	T3C	T1	T1	T1	350
		90 °C (194 °F)	40 °C (104 °F)	T2A	T2A	T2B	T2C	T3 (EF)	T3 (EF)	T4	T4A	—	—	—	—
250	PSMH	90 °C (194 °F)	55 °C (131 °F)	T2A	T2A	T2B	T2C	—	—	—	—	—	—	—	—
		90 °C (194 °F)	65 °C (149 °F)	—	—	—	T2C	—	—	—	—	—	—	—	—
		90 °C (194 °F)	40 °C (104 °F)	T2B	T2B	T2B	T2B	—	—	T3C	T3C	—	—	—	—
320	PSMH	90 °C (194 °F)	55 °C (131 °F)	T2A	T2A	T2A	T2B	—	—	—	—	—	—	—	—
		90 °C (194 °F)	40 °C (104 °F)	T2B	T2B	T2B	T2B	—	—	T3C	T3C	—	—	—	—
350	PSMH	90 °C (194 °F)	55 °C (131 °F)	T2A	T2A	T2A	T2B	—	—	—	—	—	—	—	—
		90 °C (194 °F)	40 °C (104 °F)	T2A	T2A	T2A	T2B	—	—	—	—	—	—	—	—
400	PSMH	90 °C (194 °F)	40 °C (104 °F)	T2A	T2A	T2B	T2B	—	—	T3C	T3C	—	—	—	—
		90 °C (194 °F)	40 °C (104 °F)	T2A	T2A	T2B	T2B	—	—	T3C	T3C	—	—	—	—

“T” Numbers Represent the Maximum Lamp Temperature for Class I, Division 2 Locations and Maximum Surface Temperature Under Dust Blanket for Class II, Division 1 Locations

“T” Number	T1	350	325	T2	T2A	T2B	T2C	T2D	T3	T3A	T3B	T3C	T4	T4A	T5	T6
Temp Range (°C)	351-450	326-350	301-325	281-300	261-280	231-260	216-230	201-215	181-200	166-180	161-165	136-160	121-135	101-120	86-100	85
Temp. Range (°F)	664-842	619-662	574-617	538-572	502-536	448-500	421-446	394-419	358-392	331-356	322-329	277-320	250-275	214-248	187-212	185

① Use +90 °C (+194 °F) rated supply wire.
 ② “T” numbers are for Groups E and F only.

Mercmaster™ III 400 Luminaire for Hazardous and Wet Locations

Class I, Zone 2, AEx nR IIC, AEx nA nR IIC, IP66, NEMA 4X

Temperature identification numbers of Mercmaster III – 400 Fixtures.

NEC/CEC:
 Class I, Division 2, Groups A, B, C, D
 Class I, Zone 2, AEx nA nR IIC (Z2)
 Class I, Zone 2, AEx nR IIC (ZB)
 Class II, Division 1 and 2, Groups E, F, G
 Class III

NEC/CEC:
 Simultaneous Exposure (Class I, Division 2/
 Class II, Division 1)
 Fixtures Outside Type (Salt Water)
 Type 4X
 IP66

“T” Numbers

Lamp Watts	Type	Supply Wire Temp. °C (°F) ①	Ambient Temp. °C (°F) ①	Class 1, Zone 2 AEx nA nR			Class 1, Zone 2 AEx nR		
				Globe	Globe & Reflector	Enclosed Reflector	Globe	Globe & Reflector	Enclosed Reflector
250	HPS	125 (257)	40 (104)	T4	T4	T5	T4	T4	T5
	HPS	125 (257)	55 (131)	T3	T3	T3	T3	T3	T3
	HPS	125 (257)	65 (149)	—	—	T3	—	—	T3
400	HPS	90 (194)	40 (104)	T4	T4	T5	T4	T4	T5
	PSMH	90 (194)	40 (104)	T3	T3	T3	—	—	—
	PSMH	90 (194)	55 (131)	T3	T3	T3	—	—	—
320	PSMH	90 (194)	40 (104)	T4	T4	T4	T4	T4	T4
	PSMH	90 (194)	55 (131)	T3	T3	T4	T3	T3	T4
	PSMH	90 (194)	40 (104)	T4	T4	T4	T4	T4	T4
350	PSMH	90 (194)	40 (104)	T4	T4	T4	T4	T4	T4
	PSMH	90 (194)	55 (131)	T3	T3	T4	T3	T3	T4
400	PSMH	75 (167)	40 (104)	T3	T3	T3	T3	T3	T3
400	MH	75 (167)	40 (104)	T3	T3	T3	—	—	—

“T” Numbers represent the maximum surface temperature for luminaires with AEx nA nR and AEx nR rating:

To comply with AEx nR Requirements, all wiring entries must be sealed.

“T” Number	T1	T2	T3	T4	T5	T6
Temp. Range (°C)	301-450	201-300	136-200	101-135	86-100	85
Temp. Range (°F)	547-842	394-572	277-392	214-275	187-212	185

① Use +90 °C (+194 °F) rated supply wire.

Mercmaster™ III 400 Luminaire for Hazardous and Wet Locations

250 W, 400 W HPS

Listed for simultaneous exposure to combustible dusts and flammable gases or vapors.

NEC/CEC:

Class I, Division 2, Groups A, B, C, D
 Class I, Zone 2, AEx nA nR IIC (Z2)
 Class I, Zone 2, AEx nR IIC (ZB)
 Class II, Division 1 and 2, Groups E, F, G
 Class III

NEC/CEC:

Simultaneous Exposure (Class I, Division 2/
 Class II, Division 1)
 Fixtures Outside Type (Salt Water)
 Type 4X
 IP66

Type Mounting	Lamp Type	Lamp Watts	Hub Size (Inches)	With Globe	Catalog Numbers ③④⑤	
					With Type V 12" Refractor ②	With Enclosed Reflector

Pendant — One Hub, Rigid Mounting ①



Shown with Globe

HPS	250	3/4	1	KPAL2575	KPAL2575J5	KPAL2575R
			1	KPAL2510	KPAL2510J5	KPAL2510R
HPS	400	3/4	1	KPAL4075	KPAL4075J5	KPAL4075R
			1	KPAL4010	KPAL4010J5	KPAL4010R

Pendant Cone — One Hub, Rigid Mounting



Shown with 12" Glass Refractor

HPS	250	3/4	1	KPCHL2575	KPCHL2575J5	KPCHL2575R
			1	KPCHL2510	KPCHL2510J5	KPCHL2510R
HPS	400	3/4	1	KPCHL4075	KPCHL4075J5	KPCHL4075R
			1	KPCHL4010	KPCHL4010J5	KPCHL4010R

Ceiling — Five Hubs, Four Close-Up Plugs



Shown with Enclosed Reflector

HPS	250	3/4	1	KPCL2575	KPCL2575J5	KPCL2575R
			1	KPCL2510	KPCL2510J5	KPCL2510R
HPS	400	3/4	1	KPCL4075	KPCL4075J5	KPCL4075R
			1	KPCL4010	KPCL4010J5	KPCL4010R

① For Flexible Pendant Mount, change **A** to **F** in catalog number.

② To order fixture with NEMA Type II refractor, change digits **J5** in catalog number to **J2**. Refractor not available for Z, Z2 or ZB suffix.

③ For fixtures with guards, add suffix **G** before adding voltage suffix. **BG** for refractor. **NG** for enclosed reflector.

④ Add the following voltage and frequency designations before Z2 or ZB suffix:

Lamp Type	Lamp Watts	Voltage Suffixes							
		MT	5MT	48	125	225	226	235	245
HPS	250	X	X	X	X	—	X	X	—
HPS	400	X	X	X	X	—	—	X	—
PSMH	250	—	X	X	X	—	—	X	—
PSMH	320	X	X	X	X	—	—	X	—
PSMH	350	X	X	X	X	—	—	X	—
PSMH	400	X	X	X	—	—	—	X	—

Voltages:
MT - 120/208/240/277 V 60 Hz
5MT - 120/208/240/277/480 V 60 Hz
48 - 480 V 60 Hz
125 - 120 V 50 Hz
225 - 225 V 50 Hz
226 - 220 V 60 Hz
235 - 230 V 50 Hz
245 - 240 V 50 Hz

⑤ Add **Z2** suffix for factory sealed non-sparking/restricted breathing protection (AEx nA nR). Add **ZB** suffix for restricted breathing protection (AEx nR).

Mercmaster™ III 400 Luminaire for Hazardous and Wet Locations

250 W, 400 W HPS

Listed for simultaneous exposure to combustible dusts and flammable gases or vapors.

NEC/CEC:
 Class I, Division 2, Groups A, B, C, D
 Class I, Zone 2, AEx nA nR IIC (Z2)
 Class I, Zone 2, AEx nR IIC (ZB)
 Class II, Division 1 and 2, Groups E, F, G
 Class III

NEC/CEC:
 Simultaneous Exposure (Class I, Division 2/
 Class II, Division 1)
 Fixtures Outside Type (Salt Water)
 Type 4X
 IP66

Type Mounting	Lamp Type	Lamp Watts	Hub Size (Inches)	With Globe	Catalog Numbers ③④⑤		
					With Type V 12" Refractor ②	With Enclosed Reflector	

Wall Five Hubs, Four Close-Up Plugs



HPS	250	3/4	KPWBL2575	KPWBL2575J5	KPWBL2575R
		1	KPWBL2510	KPWBL2510J5	KPWBL2510R
HPS	400	3/4	KPWBL4075	KPWBL4075J5	KPWBL4075R
		1	KPWBL4010	KPWBL4010J5	KPWBL4010R

Shown with 12" Glass Refractor

25° Stanchion One Hub



HPS	250	1-1/4	KPSL25125	KPSL25125J5	KPSL25125R
		1-1/2	KPSL25150	KPSL25150J5	KPSL25150R
HPS	400	1-1/4	KPSL40125	KPSL40125J5	KPSL40125R
		1-1/2	KPSL40150	KPSL40150J5	KPSL40150R

Shown with Prismatic Glass Globe and Optional Guard

90° Stanchion One Hub



HPS	250	1-1/4	KPSTL25125	KPSTL25125J5	KPSTL25125R
		1-1/2	KPSTL25150	KPSTL25150J5	KPSTL25150R
HPS	400	1-1/4	KPSTL40125	KPSTL40125J5	KPSTL40125R
		1-1/2	KPSTL40150	KPSTL40150J5	KPSTL40150R

Shown with Prismatic Glass Globe and Optional Guard

② To order fixture with NEMA Type II refractor, change digits **J5** in catalog number to **J2**. Refractor not available for Z, Z2 or ZB suffix.

③ For fixtures with guards, add suffix **G** before adding voltage suffix. **BG** for refractor. **NG** for enclosed reflector.

④ Add the following voltage and frequency designations before Z2 or ZB suffix:

Lamp Type	Lamp Watts	Voltage Suffixes							
		MT	5MT	48	125	225	226	235	245
HPS	250	X	X	X	X	—	X	X	—
HPS	400	X	X	X	X	—	—	X	—
PSMH	250	—	X	X	X	—	—	X	—
PSMH	320	X	X	X	X	—	—	X	—
PSMH	350	X	X	X	X	—	—	X	—
PSMH	400	X	X	X	—	—	—	X	—

Voltages:
MT - 120/208/240/277 V 60 Hz
5MT - 120/208/240/277/480 V 60 Hz
48 - 480 V 60 Hz
125 - 120 V 50 Hz
225 - 225 V 50 Hz
226 - 220 V 60 Hz
235 - 230 V 50 Hz
245 - 240 V 50 Hz

⑤ Add **Z2** suffix for factory sealed non-sparking/restricted breathing protection (AEx nA nR). Add **ZB** suffix for restricted breathing protection (AEx nR).

Mercmaster™ III 400 Luminaire for Hazardous and Wet Locations

250 W, 320 W, 350 W, 400 W PSMH



Listed for simultaneous exposure to combustible dusts and flammable gases or vapors.

NEC/CEC:

Class I, Division 2, Groups A, B, C, D
 Class I, Zone 2, AEx nA nR IIC (Z2)
 Class I, Zone 2, AEx nR IIC (ZB)
 Class II, Division 1 and 2, Groups E, F, G
 Class III

NEC/CEC:

Simultaneous Exposure (Class I, Division 2/
 Class II, Division 1)
 Fixtures Outside Type (Salt Water)
 Type 4X
 IP66

Type Mounting	Lamp Type	Lamp Watts	Hub Size (Inches)	Catalog Numbers ③④⑤		
				With Globe	With Type V 12" Refractor ②	With Enclosed Reflector
Pendant One Hub, Rigid Mounting ①						
 Shown with Globe	PSMH	250 ⑥	3/4	KPAP2575	KPAP2575J5	KPAP2575R
			1	KPAP2510	KPAP2510J5	KPAP2510R
	PSMH	320	3/4	KPAP3275	KPAP3275J5	KPAP3275R
			1	KPAP3210	KPAP3210J5	KPAP3210R
	PSMH	350	3/4	KPAP3575	KPAP3575J5	KPAP3575R
			1	KPAP3510	KPAP3510J5	KPAP3510R
	PSMH	400	3/4	KPAP4075	KPAP4075J5	KPAP4075R
			1	KPAP4010	KPAP4010J5	KPAP4010R
Pendant Cone One Hub, Rigid Mounting						
 Shown with 12" Glass Refractor	PSMH	250 ⑥	3/4	KPCHP2575	KPCHP2575J5	KPCHP2575R
			1	KPCHP2510	KPCHP2510J5	KPCHP2510R
	PSMH	320	3/4	KPCHP3275	KPCHP3275J5	KPCHP3275R
			1	KPCHP3210	KPCHP3210J5	KPCHP3210R
	PSMH	350	3/4	KPCHP3575	KPCHP3575J5	KPCHP3575R
			1	KPCHP3510	KPCHP3510J5	KPCHP3510R
	PSMH	400	3/4	KPCHP4075	KPCHP4075J5	KPCHP4075R
			1	KPCHP4010	KPCHP4010J5	KPCHP4010R
Ceiling Five Hubs, Four Close-Up Plugs						
 Shown with Enclosed Refractor	PSMH	250 ⑥	3/4	KPCP2575	KPCP2575J5	KPCP2575R
			1	KPCP2510	KPCP2510J5	KPCP2510R
	PSMH	320	3/4	KPCP3275	KPCP3275J5	KPCP3275R
			1	KPCP3210	KPCP3210J5	KPCP3210R
	PSMH	350	3/4	KPCP3575	KPCP3575J5	KPCP3575R
			1	KPCP3510	KPCP3510J5	KPCP3510R
	PSMH	400	3/4	KPCP4075	KPCP4075J5	KPCP4075R
			1	KPCP4010	KPCP4010J5	KPCP4010R

① For Flexible Pendant Mount, change **A** to **F** in catalog number.

② To order fixture with NEMA Type II refractor, change digits **J5** in catalog number to **J2**. Refractor not available for Z, Z2 or ZB suffix.

③ For fixtures with guards, add suffix **G** before adding voltage suffix. **BG** for refractor. **NG** for enclosed reflector.

④ Add the following voltage and frequency designations before Z2 or ZB suffix:

Lamp Type	Lamp Watts	Voltage Suffixes							
		MT	5MT	48	125	225	226	235	245
HPS	250	X	X	X	X	—	X	X	—
HPS	400	X	X	X	X	—	—	X	—
PSMH	250	—	X	X	X	—	—	X	—
PSMH	320	X	X	X	X	—	—	X	—
PSMH	350	X	X	X	X	—	—	X	—
PSMH	400	X	X	X	—	—	—	X	—
Voltages:		48 - 480 V 60 Hz			226 - 220 V 60 Hz				
MT - 120/208/240/277 V 60 Hz		125 - 120 V 50 Hz			235 - 230 V 50 Hz				
5MT - 120/208/240/277/480 V 60 Hz		225 - 225 V 50 Hz			245 - 240 V 50 Hz				

⑤ Add **Z2** suffix for factory sealed non-sparking/restricted breathing protection (AEx nA nR). Add **ZB** suffix for restricted breathing protection (AEx nR).

⑥ Available for 480 V, 50 Hz and 5MT ballast options. For MT and TT voltage suffix, see Mercmaster III 50-250 Luminaires.



Mercmaster™ III 400 Luminaire for Hazardous and Wet Locations

250 W, 320 W, 350 W, 400 W PSMH

Listed for simultaneous exposure to combustible dusts and flammable gases or vapors.

NEC/CEC:
 Class I, Division 2, Groups A, B, C, D
 Class I, Zone 2, AEx nA nR IIC (Z2)
 Class I, Zone 2, AEx nR IIC (ZB)
 Class II, Division 1 and 2, Groups E, F, G
 Class III

NEC/CEC:
 Simultaneous Exposure (Class I, Division 2)
 Class II, Division 1)
 Fixtures Outside Type (Salt Water)
 Type 4X
 IP66

Type Mounting	Lamp Type	Lamp Watts	Hub Size (Inches)	With Globe	Catalog Numbers ③④⑤		
					With Type V 12" Refractor ②	With Enclosed Reflector	
Wall Five Hubs, Four Close-Up Plugs							
	PSMH	250 ⑥	3/4	KPWPB2575	KPWPB2575J5	KPWPB2575R	
			1	KPWPB2510	KPWPB2510J5	KPWPB2510R	
	PSMH	320	3/4	KPWPB3275	KPWPB3275J5	KPWPB3275R	
			1	KPWPB3210	KPWPB3210J5	KPWPB3210R	
	PSMH	350	3/4	KPWPB3575	KPWPB3575J5	KPWPB3575R	
			1	KPWPB3510	KPWPB3510J5	KPWPB3510R	
	PSMH	400	3/4	KPWPB4075	KPWPB4075J5	KPWPB4075R	
			1	KPWPB4010	KPWPB4010J5	KPWPB4010R	
25° Stanchion One Hub							
	PSMH	250 ⑥	1-1/4	KPSP25125	KPSP25125J5	KPSP25125R	
			1-1/2	KPSP25150	KPSP25150J5	KPSP25150R	
	PSMH	320	1-1/4	KPSP32125	KPSP32125J5	KPSP32125R	
			1-1/2	KPSP32150	KPSP32150J5	KPSP32150R	
	PSMH	350	1-1/4	KPSP35125	KPSP35125J5	KPSP35125R	
			1-1/2	KPSP35150	KPSP35150J5	KPSP35150R	
	PSMH	400	1-1/4	KPSP40125	KPSP40125J5	KPSP40125R	
			1-1/2	KPSP40150	KPSP40150J5	KPSP40150R	
90° Stanchion One Hub							
	PSMH	250 ⑥	1-1/4	KPSTP25125	KPSTP25125J5	KPSTP25125R	
			1-1/2	KPSTP25150	KPSTP25150J5	KPSTP25150R	
	PSMH	320	1-1/4	KPSTP32125	KPSTP32125J5	KPSTP32125R	
			1-1/2	KPSTP32150	KPSTP32150J5	KPSTP32150R	
	PSMH	350	1-1/4	KPSTP35125	KPSTP35125J5	KPSTP35125R	
			1-1/2	KPSTP35150	KPSTP35150J5	KPSTP35150R	
	PSMH	400	1-1/4	KPSTP40125	KPSTP40125J5	KPSTP40125R	
			1-1/2	KPSTP40150	KPSTP40150J5	KPSTP40150R	

Shown with 12" Glass Refractor

25° Stanchion One Hub

Shown with Prismatic Glass Globe and Optional Guard

90° Stanchion One Hub

Shown with Prismatic Glass Globe and Optional Guard

② To order fixture with NEMA Type II refractor, change digits **J5** in catalog number to **J2**. Refractor not available for Z, Z2 or ZB suffix.

③ For fixtures with guards, add suffix **G** before adding voltage suffix. **BG** for refractor. **NG** for enclosed reflector.

④ Add the following voltage and frequency designations before Z2 or ZB suffix:

Lamp Type	Lamp Watts	Voltage Suffixes							
		MT	5MT	48	125	225	226	235	245
HPS	250	X	X	X	X	—	X	X	—
HPS	400	X	X	X	X	—	—	X	—
PSMH	250	—	X	X	X	—	—	X	—
PSMH	320	X	X	X	X	—	—	X	—
PSMH	350	X	X	X	X	—	—	X	—
PSMH	400	X	X	X	—	—	—	X	—

Voltages:

MT - 120/208/240/277 V 60 Hz

5MT - 120/208/240/277/480 V 60 Hz

48 - 480 V 60 Hz

125 - 120 V 50 Hz

225 - 225 V 50 Hz

226 - 220 V 60 Hz

235 - 230 V 50 Hz

245 - 240 V 50 Hz

⑤ Add **Z2** suffix for factory sealed non-sparking/restricted breathing protection (AEx nA nR). Add **ZB** suffix for restricted breathing protection (AEx nR).

⑥ Available for 480 V, 50 Hz and 5MT ballast options. For MT and TT voltage suffix, see Mercmaster III 50-250 Luminaires.

Mercmaster™ III 400 Luminaire for Hazardous and Wet Locations







High Pressure Sodium and Pulse Start Metal Halide - Hazardous and Wet Locations

Listed for simultaneous exposure to combustible dusts and flammable gases or vapors.

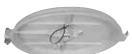
NEC/CEC:
 Class I, Division 2, Groups A, B, C, D
 Class I, Zone 2, AEx nA nR IIC (Z2)
 Class I, Zone 2, AEx nR IIC (ZB)
 Class II, Division 1 and 2, Groups E, F, G
 Class III

NEC/CEC:
 Simultaneous Exposure (Class I, Division 2/
 Class II, Division 1)
 Fixtures Outside Type (Salt Water)
 Type 4X
 IP66

Mounting Hoods

	Description	Hub Size (Inches)	Catalog Number
Pendant 	One Hub, Rigid Mounting	3/4	KPA-75
		1	KPA-100
Pendant – Flexible 	One Hub, Flexible Mounting	3/4	KPAF-75
		1	KPAF-100
Pendant Cone 	One Hub, Rigid	3/4	KPCH-75
		1	KPCH-100
Ceiling 	Five Hubs, Four Close-Up Plugs	3/4	KPC-75
		1	KPC-100
Wall 	Five Hubs, Four Close-Up Plugs	3/4	KPWB-75
		1	KPWB-100
25° Stanchion 	One Hub	1-1/4	KPS-125
		1-1/2	KPS-150
90° Stanchion 	One Hub	1-1/4	KPST-125
		1-1/2	KPST-150

Ballast Bodies



High Pressure Sodium – Constant Wattage (Min. P.F. 90%)
Pulse Start Metal Halide – Super Constant Wattage (Min. P.F. 90%)

Lamp Type	Lamp Watts	Catalog Numbers ②④	Voltage Suffixes							
			MT	5MT	48	125	225	226	235	245
HPS	250	KPB250L ①③	X	X	X	X	—	X	X	—
HPS	400	KPB400L ①③	X	X	X	X	—	—	X	—
PSMH	250	KPB250P ①③④	—	X	X	X	—	—	X	—
PSMH	320	KPB320P ①③	X	X	X	X	—	—	X	—
PSMH	350	KPB350P ①③	X	X	X	X	—	—	X	—
PSMH	400	KPB400P ①③	X	X	X	—	—	—	X	—

Voltages:

MT - 120/208/240/277 V 60 Hz

5MT - 120/208/240/277/480 V 60 Hz

48 - 480 V 60 Hz

125 - 120 V 50 Hz

225 - 225 V 50 Hz

226 - 220 V 60 Hz

235 - 230 V 50 Hz

245 - 240 V 50 Hz

① Add **-S** after voltage designation for ballast body with Smart Starter (HPS and PSMH only).

② Add **-E** after voltage designation for ballast body with provision for Quartz Emergency Light (not suitable for hazardous location).

③ Add **Z2** suffix for factory sealed non-sparking/restricted breathing protection (AEx nA nR). Add **ZB** suffix for restricted breathing protection (AEx nR).

④ Not available in MT. See Mercmaster III 50-250 Luminaires.

Mercmaster™ III 400 Luminaire for Hazardous and Wet Locations

High Pressure Sodium and Pulse Start Metal Halide - Hazardous and Wet Locations

Listed for simultaneous exposure to combustible dusts and flammable gases or vapors.

NEC/CEC:
 Class I, Division 2, Groups A, B, C, D
 Class I, Zone 2, AEx nA nR IIC (Z2)
 Class I, Zone 2, AEx nR IIC (ZB)
 Class II, Division 1 and 2, Groups E, F, G
 Class III

NEC/CEC:
 Simultaneous Exposure (Class I, Division 2/
 Class II, Division 1)
 Fixtures Outside Type (Salt Water)
 Type 4X
 IP66

Description	Catalog Number
-------------	----------------

Prismatic Glass Globes — Heat-Resistant



Glass Globe

Clear

VPGL-4HR

Enclosed Reflector Assembly



Enclosed Reflector

Heat- and impact-resistant glass lens

KPR-4HB

Light Distribution	IES/NEMA Distribution Curves	Catalog Number
--------------------	------------------------------	----------------

Closed Prismatic Glass Refractors ② — All Heat-Resistant



Glass Refractor

NEMA Type II

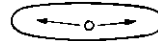

KPRF400-2

NEMA Type V



KPRF400-5

Item	Description	Catalog Number
------	-------------	----------------

White Polyester Reflectors



Standard and Deep Dome



30° Angle

For use with globe fixtures

Standard Dome

CMR-4ST①

30° Angle

CMR-4AN

Deep Dome

CMR-4DD①

Guards



Globe Guard



Refractor Guard



Enclosed Refractor Guard

Globe Guard

KPGU400

Refractor Guard

KPBG12

Enclosed Refractor Guard

G-HB7000-NG

① Contact your local sales representative if used with KPWB or KPST mounting hoods.

② Not suitable for use with Z2 or ZB suffixes (Zone 2).

Mercmaster™ III 400 Luminaire for Hazardous and Wet Locations

High Pressure Sodium and Pulse Start Metal Halide - Hazardous and Wet Locations

Listed for simultaneous exposure to combustible dusts and flammable gases or vapors.

NEC/CEC:

Class I, Division 2, Groups A, B, C, D
 Class I, Zone 2, AEx nA nR IIC (Z2)
 Class I, Zone 2, AEx nR IIC (ZB)
 Class II, Division 1 and 2, Groups E, F, G
 Class III

NEC/CEC:

Simultaneous Exposure (Class I, Division 2)
 Class II, Division 1)
 Fixtures Outside Type (Salt Water)
 Type 4X
 IP66

Electrical Specifications

Line Voltage	Type of Ballast ①	Frequency	Starting Amps	Operating Amps	Total Watts
250 Watt High Pressure Sodium					
120	C.W.A.	60	2.00	2.50	295
208	C.W.A.	60	1.20	1.50	295
240	C.W.A.	60	1.00	1.30	295
277	C.W.A.	60	0.85	1.10	295
480	C.W.A.	60	0.40	0.65	295
120	C.W.A.	50	1.85	2.75	300
230	C.W.A.	50	0.95	1.44	300
400 Watt High Pressure Sodium					
120	C.W.A.	60	3.30	3.80	465
208	C.W.A.	60	1.80	2.20	465
240	C.W.A.	60	1.60	1.90	465
277	C.W.A.	60	1.40	1.70	465
480	C.W.A.	60	0.80	1.00	465
120	C.W.A.	50	3.70	4.00	465
230	C.W.A.	50	1.85	2.00	465
250 Watt Pulse Start Metal Halide					
120	C.W.A.	60	1.96	2.50	291
208	C.W.A.	60	1.13	1.45	291
240	C.W.A.	60	0.98	1.25	291
277	C.W.A.	60	0.85	1.10	291
480	C.W.A.	60	0.32	0.69	298
480	Super C.W.A.	60	0.45	0.60	285
120	Super C.W.A.	50	1.90	2.60	288
230	Super C.W.A.	50	1.00	1.35	288
320 Watt Pulse Start Metal Halide					
120	Super C.W.A.	60	2.60	3.25	368
208	Super C.W.A.	60	1.50	1.90	368
240	Super C.W.A.	60	1.30	1.65	368
277	Super C.W.A.	60	1.15	1.40	368
480	Super C.W.A.	60	0.60	0.80	368
120	Super C.W.A.	50	2.28	3.05	365
230	Super C.W.A.	50	1.14	1.60	365
350 Watt Pulse Start Metal Halide					
120	Super C.W.A.	60	3.30	3.60	400
208	Super C.W.A.	60	1.90	2.10	400
240	Super C.W.A.	60	1.65	1.80	400
277	Super C.W.A.	60	1.40	1.55	400
480	Super C.W.A.	60	0.75	0.90	400
120	Super C.W.A.	50	2.45	3.34	394
230	Super C.W.A.	50	1.26	1.74	394
400 Watt Pulse Start Metal Halide					
120	Super C.W.A.	60	3.50	4.00	454
208	Super C.W.A.	60	2.00	2.30	454
240	Super C.W.A.	60	1.75	2.00	454
277	Super C.W.A.	60	1.50	1.25	454
480	Super C.W.A.	60	0.90	1.00	454
120	Super C.W.A.	50	3.17	3.90	454
230	Super C.W.A.	50	1.65	2.00	454

Fuse Kit

Order fuses as a separate item by catalog number from right columns.

Lamp Watts	Volts	Fuse Quantity Required	Fuse Catalog Number	
			HPS	PSMH
250	120	1	F7	—
	208	2	F4	—
	240	2	F4	—
	277	1	F3	—
	480	2	F2	—
	120	1	F7	—
	230	2	F4	—
250	480	2	—	F2
	230	1	—	F3
	120	1	—	F9
320	208	2	—	F6
	240	2	—	F5
	277	1	—	F4
	480	2	—	F3
	120	1	—	F10
	230	2	—	F5
	120	1	—	F10
350	208	2	—	F7
	240	2	—	F5
	277	1	—	F5
	480	2	—	F3
	120	1	—	F10
	230	2	—	F5
	120	1	—	F15
400	208	2	F8	F7
	240	2	F8	F5
	277	1	F5	F5
	480	2	F5	F3
	120	1	F10	F10
	230	2	F6	F5

Appleton

HID/AREA: NEC/CEC ENCLOSED AND GASKETED

① C.W.A. – Constant Wattage Autotransformer. HX-HPF – High Reactance High Power Factor Autotransformer.
 Super C.W.A. – Super Constant Wattage Autotransformer.

Mercmaster™ III 400 Luminaire for Hazardous and Wet Locations

High Pressure Sodium and Pulse Start Metal Halide - Hazardous and Wet Locations

Listed for simultaneous exposure to combustible dusts and flammable gases or vapors.

NEC/CEC:
 Class I, Division 2, Groups A, B, C, D
 Class I, Zone 2, AEx nA nR IIC (Z2)
 Class I, Zone 2, AEx nR IIC (ZB)
 Class II, Division 1 and 2, Groups E, F, G
 Class III

NEC/CEC:
 Simultaneous Exposure (Class I, Division 2/
 Class II, Division 1)
 Fixtures Outside Type (Salt Water)
 Type 4X
 IP66

Dimensions in Millimeters (Inches)

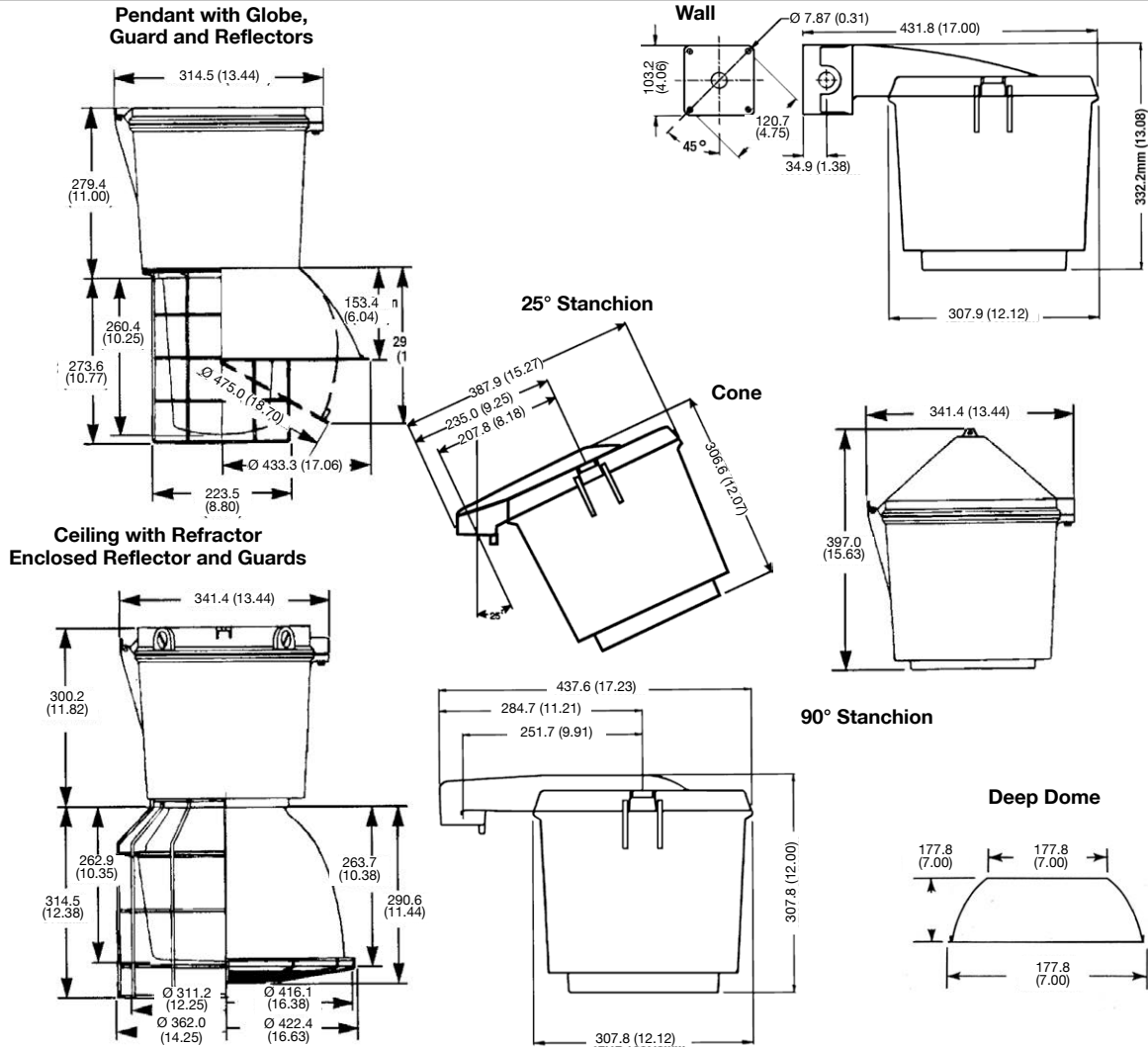

Mercmaster III – 400 Ballast and Accessory Weights

Lamp Watts	Ballast Housing Wt. kg (lb)		Mounting Hoods and Reflectors	Wt. kg (lb)	Globe Refractor, Enclosed Reflector and Guards	
	HPS	PSMH			Reflector and Guards	Wt. kg (lb)
250	11.1 (24.5)	—	Pendant	1.0 (2.25)	Glass Globe	3.2 (7.0)
320	—	12.7 (28.0)	Pendant Cone	1.1 (2.50)	Globe Guard	1.4 (3.0)
			Ceiling	1.4 (3.00)	12" Glass Refractor	5.4 (12.0)
350	—	12.9 (28.5)	Wall	1.8 (4.00)	Refractor Guard	2.0 (4.5)
			25° Stanchion	1.5 (3.25)	Enclosed Reflector	5.0 (11.0)
400	12.9 (28.5)	12.9 (28.5)	90° Stanchion	1.7 (3.75)	Enclosed Reflector Guard	0.9 (2.0)
			Standard Dome	1.6 (3.50)		
			30° Angle	1.6 (3.50)		

Weights are approximate. Add 0.11 kg (0.25 lb). for Quartz option.

PCD2 Series Factory Sealed Hazardous Location Photocontrol

For use in Class I, Division 2, Groups A, B, C, D locations

Maintains Class I, Division 2 rating for Mercmaster III – Low Profile, Mercmaster III, and Mercmaster III – 400 Series Luminaires, Mercmaster LED

NEC/CEC:
Class I, Division 2, Groups A, B, C, D
NEMA 4X

Applications

- Encapsulated photocontrol provides automatic dusk-to-dawn lighting control in Class I, Division 2 locations.
- Typical applications include walkways, security areas and any other outdoor lighting application.
- For use with Mercmaster III – Low Profile, Mercmaster III, and Mercmaster III – 400 Series Luminaires.
- For remote mounting in FS Boxes.

Features

- Factory sealed design eliminates the need for an explosionproof enclosure.
- Can be easily installed in the field.
- Solid state design for performance and reliability.
- Available for 120, 208, 240, or 277 volts.



- 50-400 W HID, incandescent or fluorescent, 50/60 Hz.
- 1000 V.A. Voltage/Ampere
- Minimum time delay: 15 seconds to eliminate nuisance tripping.
- Provided with (3) 18AWG stranded leads 152.4 mm (6 in) in length.
- Will fit through standard 1/2" knockout.
- Supplied with locknut and gasket.

Materials

- Encapsulated with epoxy sealing compound
- FS: aluminum

NEC/CEC Certifications and Compliances

- UL Standard: 1604 – Hazardous (Classified) Locations
- cULus Recognized

	Voltage Range	Max VA	Max Current Amps	Suffix Designation Catalog Number
Factory-Installed Photocontrol - Not for ceiling or pendant cone.				
<i>Add to fixture catalog after voltage; i.e.: KPWBL1075MTH1.</i>				
	120 V, 50/60 Hz	1000	—	H1
	208 V, 50/60 Hz	1000	—	H2
	240 V, 50/60 Hz	1000	—	H3
	277 V, 50/60 Hz	1000	—	H4
Photocontrol for Field Installation				
	120 V, 50/60 Hz	1000	8.3 Amp	PC120D2
	208 V, 50/60 Hz	1000	4.8 Amp	PC247D2
	240 V, 50/60 Hz	1000	4.2 Amp	
	277 V, 50/60 Hz	1000	3.6 Amp	
Photocontrol in FS Cover for Use with FS/FD Box				
<i>Supplied with two stainless steel screws. For neoprene gasket, order catalog number FS-GKR-1N.</i>				
	120 V, 50/60 Hz	1000	8.3 Amp	FSKA-PC120D2
	208, 50/60 Hz	1000	4.8 Amp	FSKA-PC247D2
	240 V, 50/60 Hz	1000	4.2 Amp	
	277 V, 50/60 Hz	1000	3.6 Amp	

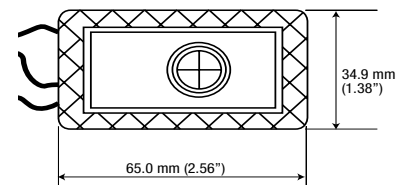
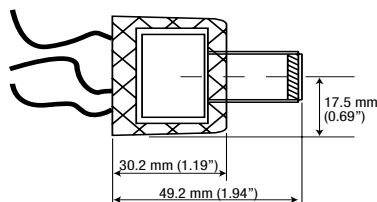
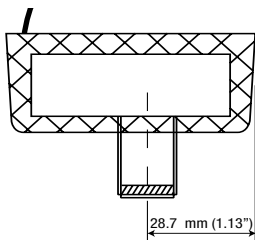

Mercmaster™ III 400 Luminaire for Hazardous and Wet Locations

400 W PSMH

* Photometric data is based on a fixture with a 400-watt clear Pulse Start Metal Halide lamp (44,000 lumen). For candlepower values of fixtures with other PSMH lamps, use the following multipliers: for a 320 W (33,000 lumen) PSMH lamp – .750; for a 350 W (37,000 lumen) PSMH lamp – .840. For candlepower values of fixture with guard, multiply by – 0.95.

NEC/CEC:

Class I, Division 2, Groups A, B, C, D
 Class I, Zone 2, AEx nA nR IIC (Z2)
 Class I, Zone 2, AEx nR IIC (ZB)
 Class II, Division 1 and 2, Groups E, F, G
 Class III

NEC/CEC:

Simultaneous Exposure (Class I, Division 2)
 Class II, Division 1)
 Fixtures Outside Type (Salt Water)
 Type 4X
 IP66

Photometric Data

Zone Lumens TOTAL LUMINAIRE EFFICIENCY = 92.6%

Zone	Lumens	CIE Type – General Diffuse
0-10	118.85	
10-20	488.36	
20-30	948.99	
30-40	1678.84	
40-50	2714.15	
50-60	3299.55	
60-70	3919.47	
70-80	4497.45	
80-90	4892.41	
90-100	4803.79	
100-110	4404.56	
110-120	3849.71	
120-130	3078.18	
130-140	1852.83	
140-150	185.86	
150-160	14.88	
160-170	1.78	
170-180	0.12	

ZONAL LUMEN SUMMARY

Zone	Lumens	% Lamp	% Fixture
0-30	1556.19	3.5	3.8
0-40	3235.03	7.4	7.9
0-60	9248.74	21.0	22.7
0-90	22558.07	51.3	55.4
90-120	13058.07	29.7	32.0
90-130	16136.25	36.7	39.6
90-150	18174.93	41.3	44.6
90-180	18191.71	41.3	44.6
0-180	40749.78	92.6	100.0

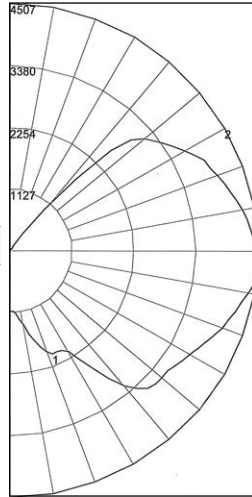

REPORT NUMBER: **KP40PG**

Lamps: 400 W Pulse Start Metal Halide with Globe *

Coefficients of Utilization – Zonal Cavity Method

Effective Floor Cavity Reflectance 0.20

% Ceiling	Rcc	80			70			50			30			10			0	
		70	50	30	10	70	50	30	10	50	30	10	50	30	10			
0	100	100	100	100	93	93	93	93	80	80	80	68	68	68	57	57	57	51
1	86	80	74	69	79	73	68	64	62	58	54	51	48	45	41	39	37	32
2	76	67	59	52	70	61	54	48	51	45	41	42	37	33	33	30	27	22
3	68	57	48	41	62	52	44	38	45	37	32	35	30	26	28	24	20	16
4	62	49	40	33	56	45	37	30	37	31	26	30	25	21	24	20	16	13
5	56	43	34	27	51	40	31	25	33	26	21	27	21	17	21	17	13	10
6	51	38	29	23	47	35	27	21	29	23	18	24	18	14	18	14	11	8
7	47	34	25	20	43	31	24	18	26	20	15	21	16	12	17	12	9	7
8	44	31	22	17	40	28	21	16	24	17	13	19	14	10	15	11	8	6
9	41	28	20	15	37	26	18	14	21	15	11	18	13	9	14	10	7	5
10	38	25	18	13	35	23	16	12	20	14	10	16	11	8	13	9	6	4

Zone Lumens TOTAL LUMINAIRE EFFICIENCY = 81.4%

Zone	Lumens	CIE Type – Direct
0-10	561.93	
10-20	1748.92	
20-30	2859.54	
30-40	4018.21	
40-50	5254.58	
50-60	5772.38	
60-70	6052.84	
70-80	5887.04	
80-90	3512.71	
90-100	137.17	
100-110	0.00	
110-120	0.00	
120-130	0.00	
130-140	0.00	
140-150	0.00	
150-160	0.00	
160-170	0.00	
170-180	0.00	

ZONAL LUMEN SUMMARY

Zone	Lumens	% Lamp	% Fixture
0-30	5170.39	11.8	14.4
0-40	9188.60	20.9	25.7
0-60	20215.55	45.9	56.5
0-90	35668.14	81.1	99.6
90-120	137.17	0.3	0.4
90-130	137.17	0.3	0.4
90-150	137.17	0.3	0.4
90-180	137.17	0.3	0.4
0-180	35805.32	81.4	100.0

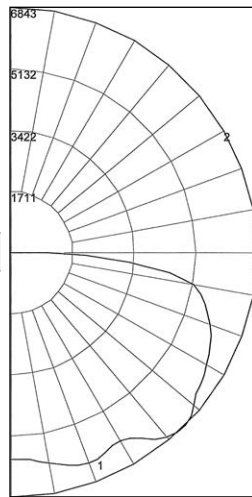

REPORT NUMBER: **KP40PST**

Lamps: 400 W Pulse Start Metal Halide with Standard Dome Reflector *

Coefficients of Utilization – Zonal Cavity Method

Effective Floor Cavity Reflectance 0.20

% Ceiling	Rcc	80			70			50			30			10			0	
		70	50	30	10	70	50	30	10	50	30	10	50	30	10			
0	97	97	97	97	95	95	95	95	90	90	90	86	86	86	83	83	83	81
1	84	78	73	68	81	76	71	67	72	69	65	69	66	63	66	63	61	59
2	74	65	58	51	72	63	57	51	60	54	49	57	52	48	55	51	47	45
3	66	55	47	40	64	54	46	40	51	44	39	49	43	38	46	42	37	35
4	60	48	39	32	58	47	39	32	44	37	32	42	36	31	40	35	31	28
5	55	42	33	27	53	41	33	27	39	32	26	37	31	26	36	30	26	24
6	50	37	29	23	48	36	28	23	35	28	22	33	27	22	32	26	22	20
7	46	33	25	20	44	33	25	19	31	24	19	30	24	19	29	23	19	17
8	43	30	22	17	41	30	22	17	28	22	17	27	21	17	26	21	17	15
9	40	28	20	15	38	27	20	15	26	19	15	25	19	15	24	19	15	13
10	37	25	18	13	36	25	18	13	24	18	13	23	17	13	22	17	13	12

Mercmaster™ III 400 Luminaire for Hazardous and Wet Locations

400 W PSMH

* Photometric data is based on a fixture with a 400-watt clear Pulse Start Metal Halide lamp (44,000 lumen). For candlepower values of fixtures with other PSMH lamps, use the following multipliers: for a 320 W (33,000 lumen) PSMH lamp – .750; for a 350 W (37,000 lumen) PSMH lamp – .840. For candlepower values of fixture with guard, multiply by – 0.95.

NEC/CEC:

Class I, Division 2, Groups A, B, C, D
Class I, Zone 2, AEx nA nR IIC (Z2)
Class I, Zone 2, AEx nR IIC (ZB)
Class II, Division 1 and 2, Groups E, F, G
Class III

NEC/CEC:

Simultaneous Exposure (Class I, Division 2/
Class II, Division 1)
Fixtures Outside Type (Salt Water)
Type 4X
IP66

Photometric Data

Zone Lumens TOTAL LUMINAIRE EFFICIENCY = 76%

Zone	Lumens	CIE Type – Direct	
		Plane	Spacing Criteria
0-10	499.96		
10-20	1605.38		
20-30	2680.72		
30-40	3841.49	0-180	2.28
40-50	4899.23	90-270	1.92
50-60	4819.21	Diagonal	1.84
60-70	4564.58		
70-80	4063.65		
80-90	3258.13		

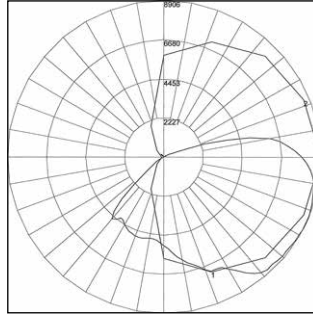

REPORT NUMBER: **KP40PAN**
 Lamps: 400 W Pulse Start Metal Halide with
 30° Angle Dome Reflector *

Coefficients of Utilization – Zonal Cavity Method

Effective Floor Cavity Reflectance 0.20

% Ceiling	Rcc	80				70				50				30				10				0
		70	50	30	10	70	50	30	10	50	30	10	50	30	10	50	30	10				
% Walls	Rw																					
	0	89	89	89	89	86	86	86	86	80	80	80	75	75	75	71	71	71	69			
	1	78	72	68	64	75	70	66	62	65	62	59	61	58	56	57	55	53	50			
	2	69	61	55	49	66	59	53	48	55	50	46	51	47	43	48	44	41	39			
	3	62	52	45	39	59	51	44	38	47	41	37	44	39	35	41	37	33	31			
	4	56	46	38	32	54	44	37	31	41	35	30	38	33	29	36	31	28	26			
	5	51	40	33	27	49	39	32	26	36	30	25	34	29	24	32	27	23	21			
	6	47	36	28	23	45	35	28	22	32	26	22	30	25	21	29	24	20	18			
	7	43	32	25	20	42	31	24	19	29	23	19	27	22	18	26	21	17	16			
	8	40	29	22	17	39	28	22	17	27	21	16	25	20	16	24	19	15	14			
	9	37	26	20	15	36	26	19	15	24	19	15	23	18	14	22	17	14	12			
	10	35	24	18	14	34	24	17	13	22	17	13	21	16	13	20	15	12	11			

ZONAL LUMEN SUMMARY

Zone	Lumens	% Lamp	% Fixture
100-110	762.24		
110-120	138.12	0-30	4786.06 10.9 14.3
120-130	77.59	0-40	8627.55 19.6 25.8
130-140	73.07	0-60	18345.99 41.7 54.9
140-150	25.07	0-90	30232.35 68.7 90.4
150-160	10.91	90-120	3005.49 6.8 9.0
160-170	5.30	90-130	3083.09 7.0 9.2
170-180	1.45	90-150	3181.23 7.2 9.5
		90-180	3198.89 7.3 9.6
		0-180	33431.25 76.0 100.0



HID/AREA: NEC/CEC ENCLOSED AND GASKETED

Mercmaster™ III 400 Luminaire for Hazardous and Wet Locations

400 W PSMH

* Photometric data is based on a fixture with a 400-watt clear Pulse Start Metal Halide lamp (44,000 lumen). For candlepower values of fixtures with other PSMH lamps, use the following multipliers: for a 320 W (33,000 lumen) PSMH lamp – .750; for a 350 W (37,000 lumen) PSMH lamp – .840. For candlepower values of fixture with guard, multiply by – 0.95.

NEC/CEC:
 Class I, Division 2, Groups A, B, C, D
 Class I, Zone 2, AEx nA nR IIC (Z2)
 Class I, Zone 2, AEx nR IIC (ZB)
 Class II, Division 1 and 2, Groups E, F, G
 Class III

NEC/CEC:
 Simultaneous Exposure (Class I, Division 2)
 Class II, Division 1)
 Fixtures Outside Type (Salt Water)
 Type 4X
 IP66

Photometric Data

Zone Lumens TOTAL LUMINAIRE EFFICIENCY = 78.4%

Zone	Lumens	TOTAL LUMINAIRE EFFICIENCY = 78.4%		
0-10	77.24	CIE Type – Semi-Direct		
10-20	575.14	Plane	Spacing Criteria	
20-30	1061.45			
30-40	1581.40	0-180	1.36	
40-50	4468.52	90-270	1.40	
50-60	4938.88	Diagonal	2.42	
60-70	6338.26	ZONAL LUMEN SUMMARY		
70-80	5875.90	Zone	Lumens	% Lamp % Fixture
80-90	3886.90	0-30	1713.83	3.9 5.0
90-100	1318.17	0-40	3295.23	7.5 9.6
100-110	1872.98	0-60	12702.64	28.9 36.8
110-120	1122.17	0-90	28803.69	65.5 83.5
120-130	616.83	90-120	4313.33	9.8 12.5
130-140	358.56	90-130	4930.15	11.2 14.3
140-150	224.03	90-150	5512.75	12.5 16.0
150-160	128.38	90-180	5699.61	13.0 16.5
160-170	50.79	0-180	34503.3	78.4 100.0
170-180	7.69			

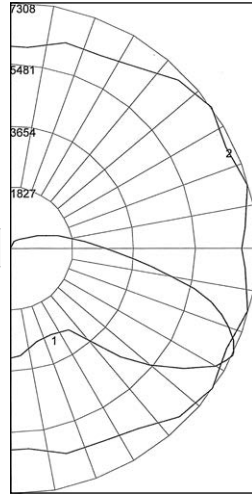

REPORT NUMBER: **KP40PJ5**

Lamps: 400 W Pulse Start Metal Halide with
 8" Prismatic Glass Refractor – NEMA Type V *

Coefficients of Utilization – Zonal Cavity Method

Effective Floor Cavity Reflectance 0.20

% Floors Rfc	% Ceiling Rcc	% Walls Rw	20															
			80			70			50			30			10			0
0	90	90	90	90	87	87	87	87	80	80	80	74	74	74	68	68	68	65
1	77	71	66	61	73	68	63	59	62	58	54	57	53	50	52	49	47	44
2	67	58	50	44	64	55	48	42	50	44	39	45	41	37	41	37	34	31
3	59	48	40	33	56	46	38	32	42	35	30	38	32	27	34	29	25	23
4	53	41	33	26	50	39	31	25	35	29	23	32	26	21	29	24	20	17
5	48	36	27	21	45	34	26	20	31	24	18	28	22	17	25	20	16	13
6	44	31	23	17	41	30	22	16	27	20	15	24	18	14	22	17	13	11
7	40	28	20	14	38	26	19	14	24	17	13	22	16	12	19	14	11	9
8	37	25	17	12	35	24	17	11	22	15	11	19	14	10	18	13	9	7
9	34	22	15	10	32	21	15	10	20	13	9	18	12	8	16	11	8	6
10	32	20	14	9	30	20	13	9	18	12	8	16	11	7	15	10	7	5

Zone Lumens TOTAL LUMINAIRE EFFICIENCY = 64.2%

Zone	Lumens	TOTAL LUMINAIRE EFFICIENCY = 64.2%		
0-10	514.26	CIE Type – Direct		
10-20	1734.49	Plane	Spacing Criteria	
20-30	3370.99			
30-40	5333.06	0-180	2.32	
40-50	7165.13	90-270	2.32	
50-60	6195.93	Diagonal	2.04	
60-70	2879.28	ZONAL LUMEN SUMMARY		
70-80	921.95	Zone	Lumens	% Lamp % Fixture
80-90	111.28	0-30	5619.74	12.8 19.9
90-100	0.14	0-40	10952.81	24.9 38.8
100-110	0.00	0-60	24313.86	55.3 86.1
110-120	0.00	0-90	28226.37	64.2 100.0
120-130	0.00	90-120	0.14	0.0 0.0
130-140	0.00	90-130	0.14	0.0 0.0
140-150	0.00	90-150	0.14	0.0 0.0
150-160	0.00	90-180	0.14	0.0 0.0
160-170	0.00	0-180	28226.50	64.2 100.0
170-180	0.00			

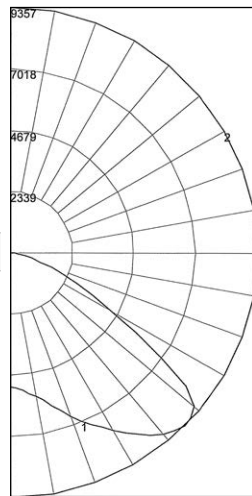

REPORT NUMBER: **KP40PHB**

Lamps: 400 W Pulse Start Metal Halide with
 Enclosed Reflector (**KPR-4HB**) *

Coefficients of Utilization – Zonal Cavity Method

Effective Floor Cavity Reflectance 0.20

% Floors Rfc	% Ceiling Rcc	% Walls Rw	20															
			80			70			50			30			10			0
0	76	76	76	76	75	75	75	75	71	71	71	68	68	68	65	65	65	64
1	70	67	65	63	69	66	64	62	63	61	60	61	59	58	59	57	56	55
2	64	59	55	51	62	58	54	50	55	52	49	53	51	48	51	49	47	46
3	58	51	46	42	56	50	46	42	48	44	41	47	43	40	45	42	40	38
4	53	45	39	35	51	44	39	35	43	38	34	41	37	34	40	36	33	32
5	48	40	34	30	47	39	34	29	38	33	29	36	32	29	35	31	28	27
6	44	35	29	25	43	35	29	25	34	29	25	32	28	25	31	28	24	23
7	41	32	26	22	39	31	26	22	30	25	22	29	25	21	28	24	21	20
8	37	29	23	19	36	28	23	19	27	22	19	26	22	19	26	22	19	17
9	35	26	20	17	34	25	20	17	25	20	17	24	20	16	23	19	16	15
10	32	24	18	15	32	23	18	15	23	18	15	22	18	15	21	17	15	13

Mercmaster™ III 400 Luminaire for Hazardous and Wet Locations

High Pressure Sodium, Pulse Start Metal Halide and Metal Halide

Listed for simultaneous exposure to combustible dusts and flammable gases or vapors.

CEC:

Class I, Division 2, Groups A, B, C, D
Class I, Zone 2, Ex nR IIC (Z)
Class II, Division 1 and 2, Groups E, F, G
Class III

CEC:

Type 4X
IP66

Applications

- Enclosed and gasketed fixtures suitable for use in:
 - Marine and wet locations
 - A wide range of industrial, chemical processing and other areas where flammable gases and vapors or combustible dusts are present under conditions defined by the National Electrical Code as Class I, Division 2; Class II, Division 1 and 2; and Class III
 - In applications involving medium and high mounting heights
 - In applications where energy efficient, high lumen output is required
 - The Ex nR Mercmaster III fixture requires all wiring entries to be sealed.
 - Non-hazardous locations where severe weather conditions, excessive moisture, dirt, dust, corrosive atmosphere or high ambient temperatures are encountered
- Typical applications include:
 - Pulp and paper mills
 - Processing plants
 - Chemical plants
 - Oil refineries
 - Foundries
 - Manufacturing plants
 - Storage areas
 - Waste and sewage treatment
 - Other areas where dust, water, dirt and rough usage are a problem

Features

- Superior corrosion resistance.
- Choice of light sources: high pressure sodium, and pulse start metal halide.
- Six mounting arrangements to suit any lighting layout: pendant, ceiling, wall bracket, 25° (angle) stanchion, 90° (straight) stanchion and cone.
- Hinge has high lip for added safety during installation and servicing. Hinge and bolt construction assures 360° compression at all points on ballast housing gasket for positive sealing. Swing away design of captive bolt and nut simplifies servicing.
- Choice of optical assemblies: prismatic globe; enclosed reflector with sealed lens; or Type V or Type II closed prismatic glass refractor, with or without guards.
- Wide choice of photometric distributions.
- All fixtures designed to perform in a 40 °C (104 °F) ambient temperature. Selected fixtures are suitable for ambient temperatures up to 65 °C (149 °F).
- Mogul base porcelain lamp holder with nickel-plated contacts has 200 °C (392 °F) rated welded leads, pre-wired to the ballast. Assures trouble-free operation in installations where high ambient temperatures are encountered.
- For electrical protection, a ground wire is provided on each Mercmaster to bond hood and ballast housing.
- Terminal blocks are provided for Zone 2 fixtures to facilitate wiring.
- Standard dome of 30° angle reflectors made of fiberglass reinforced white polyester. Highly resistant to corrosive atmospheres.
- A wide range of voltages available (120 to 600 Volt) and ballast types (CWA, CWI and Super CWA).
- One-piece ballast housing for each component provides even heat dissipation for cooler operation and longer ballast life.
- All Mercmaster mounting hoods have provision for easy field installation of fuses in fixtures (see fuse kit listings).



Enclosed Reflector



Prismatic Glass Globe



12" Glass Refractor

Standard Materials

- Mounting hoods and ballast bodies: cast copperfree (less than 4/10 of 1% copper) aluminum
- Reflectors: Fiberglass reinforced white polyester
- Guards, hardware and catch assemblies: stainless steel
- Globe: heat- and impact-resistant internally fluted glass
- Refractors: prismatic glass
- Enclosed reflector: etched Alzak aluminum with sealed, tempered heat- and impact-resistant lens
- Body and globe gaskets: high-temperature silicone rubber

Standard Finishes

- Mounting hoods and guards: epoxy powder coat, electrostatically applied for complete and uniform protection

Options

- Ex nR fixtures are available with a Class I, Zone 2 rating. Add suffix **-Z**
- Quartz Auxiliary comes to full brightness immediately and remains lit until the HID lamp attains 60-70% of full illumination. Quartz Auxiliary supplied with relay switch and socket to accept 120 V quartz double-contact bayonet base lamp (not included). (Not suitable for hazardous locations.) Add suffix **-E**.
- Factory sealed photocontrol available. See PCD2 Series.
- Smart Starter incorporates a 1-1/2-minute timer and performs as a conventional starter to normally start lamp. Removes itself from circuit if lamp burns out or is removed from socket. Eliminates starter failures caused by prolonged operation with cycling or failing lamps and simplifies finding their location, reducing maintenance and repair costs. Available for all HPS and PSMH fixtures. Add suffix **-S**.

CEC Certifications and Compliances

- CSA Certified: 025428
- CSA Standard: CSA C22.2 No. 9, C22.2 No. 137; CAN/CSA E60079-0, E60079-15
- 250 W PSMH not available in MT ballast. See Mercmaster III, 50-250 Luminaires.

Appleton

HID/AREA: NEC/CEC ENCLOSED AND GASKETED

Mercmaster™ III 400 Luminaire for Hazardous and Wet Locations

High Pressure Sodium, Pulse Start Metal Halide and Metal Halide

Listed for simultaneous exposure to combustible dusts and flammable gases or vapors.

CEC:
Class I, Division 2, Groups A, B, C, D
Class I, Zone 2, Ex nR IIC (Z)
Class II, Division 1 and 2, Groups E, F, G
Class III

CEC:
Type 4X
IP66

Illustrated Features



High Temperature Sockets

Mogul base high-temperature porcelain sockets.

Aluminum Inner Reflector

Solid aluminum inner reflector (for refractor ballast housings only) improves photometric efficiency.

Globe Chamber

Completely sealed from the ballast housing and outside vapors/air (nR).



Vented Reflectors

Reflectors are thick, tough fiberglass-reinforced white polyester, vented for cooler operation. Quickly attach with furnished stainless steel screws.

Terminal Blocks (Zone 2)

A seven-point terminal block is provided to facilitate wiring. Terminal block accommodates wire size ranging from #8 to #24 AWG.

Stainless Steel Inserts

Ballast bodies have stainless steel threaded inserts to receive stainless steel screws for reflectors and guard. Prevents "freezing", allowing guards and reflectors to be easily removed and replaced at any time, without damage to the housing.



Ballast Assembly

Utilizing non-sparking components avoiding the ignition of gases or vapors that may be present (nA).

Mounting Hood and Globe Gaskets

Silicone rubber gasket seals out moisture, dirt and dust. Stays flexible, withstands high temperatures. Closure design assures uniform gasket compression.

Electrical Protection

Ground wire provided to bond mounting hood to ballast housing.



"Safety" High Hinge

Extra-high hinge provides additional protection against accidental ballast housing disengagement during installation or maintenance.

Epoxy Finish

Ballast housing, hoods and guards are copperfree aluminum with epoxy powder coat finish.

Photocell

Available for all fixtures except cone and ceiling mount. Installs through knock-out in mounting hood. Provides continuous ON-OFF dusk-to-dawn control.



Cooler Operating Cone Hood

Larger sloped surface sheds dusts, dirt and combustible fibers providing better heat dissipation.



Stainless Steel Latch Assembly

Captive, stainless steel latch assembly bolt and nut closes securely, resists attack of corrosive atmospheres. Swing-away design simplifies servicing.

Prismatic Glass Globes, Reflectors and Enclosed Reflector

Heat-resistant globes, reflectors and enclosed reflector thread into ballast housing and seal against a high temperature silicone rubber gasket.



Fuses

Two screws secure fuse kit to mounting boss in any Mercmaster mounting hood. Fuse included.

Mercmaster™ III 400 Luminaire for Hazardous and Wet Locations

High Pressure Sodium, Pulse Start Metal Halide and Metal Halide

Listed for simultaneous exposure to combustible dusts and flammable gases or vapors.

CEC:
 Class I, Division 2, Groups A, B, C, D
 Class I, Zone 2, Ex nR IIC (Z)
 Class II, Division 1 and 2, Groups E, F, G
 Class III

CEC:
 Type 4X
 IP66
 IP66

Mercmaster III 400 Family Tree

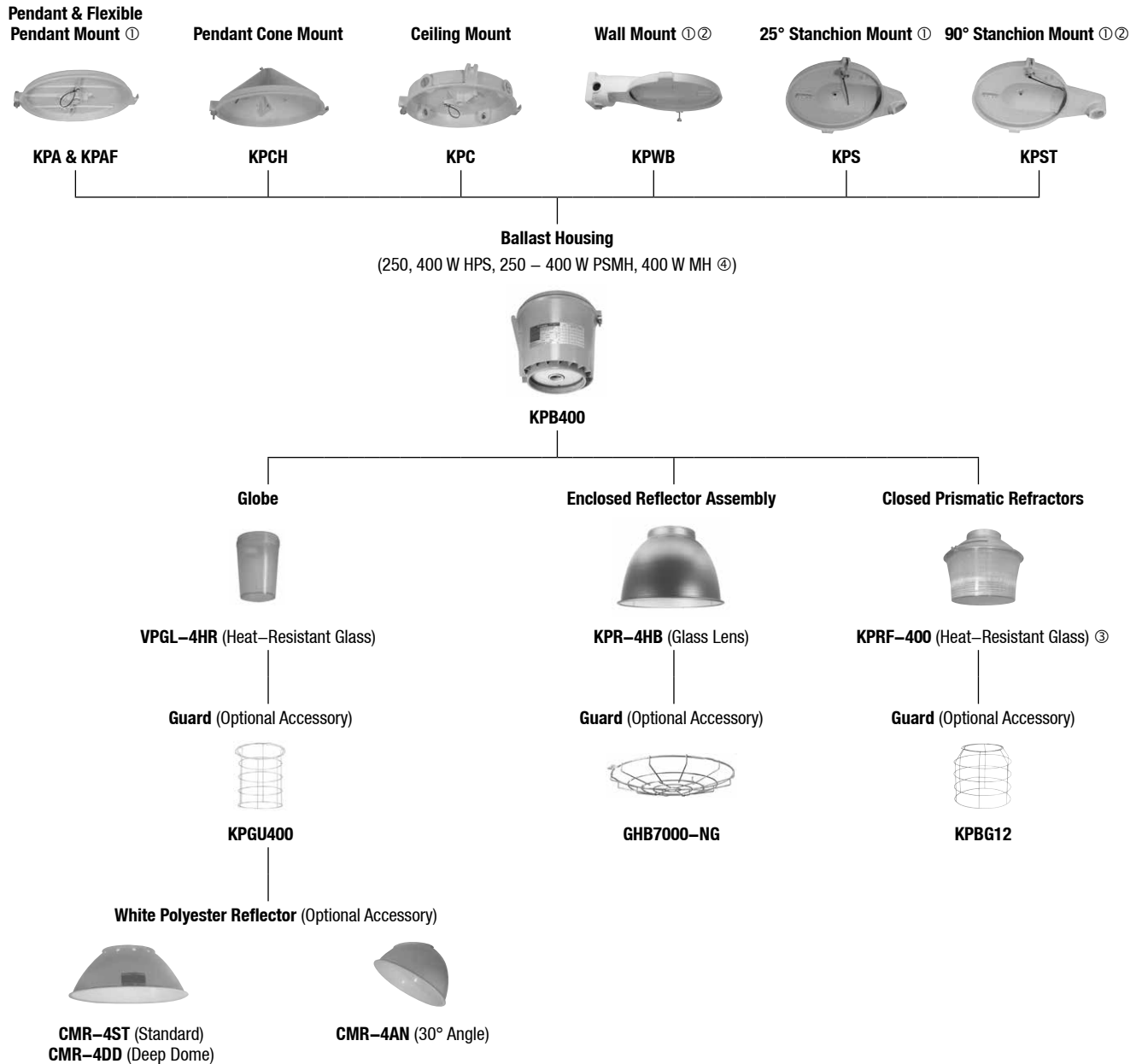

① Mounting hood with a 120 V or 208-277 V factory installed photocell is available.
 ② Standard and deep dome reflectors may interfere with bottom conduit entry if used with KPST and KPWB mounting hoods.
 ③ Available in NEMA Type II and V.
 ④ Mercury vapor and metal halide luminaires are not available for purchase within the United States. Please check with your countries governing legislation regarding allowable lamp types before ordering.

 HID/AREA: NEC/CEC ENCLOSED AND GASKETED

Mercmaster™ III 400 Luminaire for Hazardous and Wet Locations

High Pressure Sodium, Pulse Start Metal Halide and Metal Halide

Listed for simultaneous exposure to combustible dusts and flammable gases or vapors.

CEC:
 Class I, Division 2, Groups A, B, C, D
 Class I, Zone 2, Ex nR IIC (Z)
 Class II, Division 1 and 2, Groups E, F, G
 Class III

CEC:
 Type 4X
 IP66
 IP66

Order using catalog numbering guide below or select catalog number from tables on following pages.

Catalog Numbering Guide

<p>KP</p> <p>Series: KP - Mercmaster III 400</p>	<p>A</p> <p>Mounting: A - Pendant (rigid mounting) C - Ceiling D - Threaded Dust Cone R - Right Angled Stanchion (90°) S - Angled Stanchion (25°) W - Wall</p>	<p>L</p> <p>Lamp Type: H - Metal Halide (MH) ⑥ L - High Pressure Sodium (HPS) P - Pulse Start Metal Halide (PS)</p>	<p>40</p> <p>Wattage: 25 - 250 W HPS/MH ④ 40 - 400 W HPS/MH</p>	<p>10</p> <p>Hub Size: 2 - 3/4" NPT 3 - 1" NPT 4 - 1-1/4" NPT stanchion 5 - 1-1/2" NPT stanchion</p>	<p>J5</p> <p>Optical Assembly: ① J2 - NEMA II Glass Refractor J5 - NEMA V Glass Refractor ORL - Highbay Reflector/ Lens G4 - Globe</p>	<p>G</p> <p>Guard Options: ② G - Globe Guard (Not for use on RL Highbay Reflector) N - No Guard</p>	<p>MT</p> <p>Voltage: ③ C2 - 208 V 60 Hz, CWI C3 - 240 V 60 Hz, CWI C6 - 480 V 60 Hz, CWI C7 - 600 V 60 Hz, CWI MT- 120, 208, 240, 277 V, 60 Hz, CWA TT - 120, 277, 347 V, 60 Hz, CWA XP - 220-240 V, 50 Hz, CWA</p>	<p>S</p> <p>Options: E - Emergency Quartz F - Fuse (Specify Voltage) S - Smart Starter C - Safety Cable Adapted D - E-40 Export Socket T - Terminal Blocks V - Anti-Vibration Modifications X - Appledapter ⑤ Mounting Hood Adapter</p>	<p>Z2</p> <p>Suffix: Z - Zone 2 suffix (required for Ex nR)</p>
--	---	---	--	---	--	---	---	--	---

Refer to "Mounting Hoods and Ballast" page for available Voltage Configuration.

① NO DESIGNATION is required for fixtures with standard type globe.

② NO DESIGNATION is required for fixtures without guards.

③ Other voltages available. Contact your local sales representative.

④ Available for 480 V, 50 Hz and 5MT ballast options. For MT and TT voltage suffix, see Mercmaster III 50-250 Luminaires.

⑤ Appledapter is available for use with the pendant, ceiling and angled stanchion mounting only.

⑥ Mercury vapor and metal halide luminaires are not available for purchase within the United States. Please check with your countries governing legislation regarding allowable lamp types before ordering.

Mercmaster™ III 400 Luminaire for Hazardous and Wet Locations

Class I, Division 2; Class II, Division 1; Simultaneous Exposure to Hazardous Conditions on Both Classifications

Temperature identification numbers of Mercmaster III – 400 Fixtures.

CEC:

Class I, Division 2, Groups A, B, C, D
 Class I, Zone 2, Ex nR IIC (Z)
 Class II, Division 1 and 2, Groups E, F, G
 Class III

CEC:

Type 4X
 IP66

“T” Numbers

Lamp Watts	Supply Wire Temp. °C Type (°F) ①	Ambient Temp. °C (°F) ①	Class I, Division 2				Class II, Division 1 Groups E, F and G				Simultaneous Exposure Class I, Division 2 / Class II, Division 1				
			Globe	Reflector	Reflector	Enclosed Reflector	Globe	Reflector	Reflector	Enclosed Reflector	Globe	Reflector	Reflector	Enclosed Reflector	
250	HPS	125 °C (257 °F)	40 °C (104 °F)	T2	T2	T2	T2	T3B	T3B	T4	T4A	325	325	325	325
		125 °C (257 °F)	55 °C (131 °F)	325	325	T2	T2	—	—	T3B	T4A	—	—	T1	325
		125 °C (257 °F)	65 °C (149 °F)	—	—	T2	T2	—	—	T3B	T4	—	—	T1	350
400	HPS	90 °C (194 °F)	40 °C (104 °F)	350	T1	T1	350	T3 ②	T3 ②	T3C	T3C	T1	T1	T1	350
		90 °C (194 °F)	40 °C (104 °F)	T2A	T2A	T2B	T2C	T3 (EF)	T3 (EF)	T4	T4A	—	—	—	—
250	PSMH	90 °C (194 °F)	55 °C (131 °F)	T2A	T2A	T2B	T2C	—	—	—	—	—	—	—	—
		90 °C (194 °F)	65 °C (149 °F)	—	—	—	T2C	—	—	—	—	—	—	—	—
		90 °C (194 °F)	40 °C (104 °F)	T2B	T2B	T2B	T2B	—	—	T3C	T3C	—	—	—	—
320	PSMH	90 °C (194 °F)	55 °C (131 °F)	T2A	T2A	T2A	T2B	—	—	—	—	—	—	—	—
		90 °C (194 °F)	40 °C (104 °F)	T2B	T2B	T2B	T2B	—	—	T3C	T3C	—	—	—	—
350	PSMH	90 °C (194 °F)	55 °C (131 °F)	T2A	T2A	T2A	T2B	—	—	—	—	—	—	—	—
		90 °C (194 °F)	40 °C (104 °F)	T2B	T2B	T2B	T2B	—	—	T3C	T3C	—	—	—	—
400	PSMH	90 °C (194 °F)	40 °C (104 °F)	T2A	T2A	T2B	T2B	—	—	T3C	T3C	—	—	—	—
400	MH ③	90 °C (194 °F)	40 °C (104 °F)	T2	T2	T2A	T2A	—	—	T3A	T4	—	—	—	—

“T” Numbers Represent the Maximum Lamp Temperature for Class I, Division 2 Locations and Maximum Surface Temperature Under Dust Blanket for Class II, Division 1 Locations

“T” Number	T1	350	325	T2	T2A	T2B	T2C	T2D	T3	T3A	T3B	T3C	T4	T4A	T5	T6
Temp Range (°C)	351-450	326-350	301-325	281-300	261-280	231-260	216-230	201-215	181-200	166-180	161-165	136-160	121-135	101-120	86-100	85
Temp. Range (°F)	664-842	619-662	574-617	538-572	502-536	448-500	421-446	394-419	358-392	331-356	322-329	277-320	250-275	214-248	187-212	185

① Use +90 °C (+194 °F) rated supply wire.

② “T” numbers are for Groups E and F only.

③ Mercury vapor and metal halide luminaires are not available for purchase within the United States. Please check with your countries governing legislation regarding allowable lamp types before ordering.

Mercmaster™ III 400 Luminaire for Hazardous and Wet Locations

Class I, Zone 2, Ex nR IIC, IP66, NEMA 4X

Temperature identification numbers of Mercmaster III – 400 Fixtures.

CEC:
 Class I, Division 2, Groups A, B, C, D
 Class I, Zone 2, Ex nR IIC (Z)
 Class II, Division 1 and 2, Groups E, F, G
 Class III

CEC:
 Type 4X
 IP66
 IP66

“T” Numbers

Watts	Lamp Type	Supply Wire Temp. °C (°F) ①	Ambient Temp. °C (°F) ①	Class 1, Zone 2 Ex nR		
				Globe	Globe & Reflector	Enclosed Reflector
250	HPS	125 (257)	40 (104)	T4	T4	T5
	HPS	125 (257)	55 (131)	T3	T3	T3
	HPS	125 (257)	65 (149)	—	—	T3
400	HPS	90 (194)	40 (104)	T4	T4	T5
	PSMH	90 (194)	40 (104)	T3	T3	T3
	PSMH	90 (194)	55 (131)	T3	T3	T3
320	PSMH	90 (194)	40 (104)	—	—	T3
	PSMH	90 (194)	40 (104)	T4	T4	T4
	PSMH	90 (194)	55 (131)	T3	T3	T4
350	PSMH	90 (194)	40 (104)	T4	T4	T4
	PSMH	90 (194)	55 (131)	T3	T3	T4
400	PSMH	75 (167)	40 (104)	T3	T3	T3
400	MH ②	75 (167)	40 (104)	T3	T3	T3

“T” Numbers represent the maximum surface temperature for luminaires with Ex nR rating:

To comply with AEx nR Requirements, all wiring entries must be sealed.

“T” Number	T1	T2	T3	T4	T5	T6
Temp. Range (°C)	301-450	201-300	136-200	101-135	86-100	85
Temp. Range (°F)	547-842	394-572	277-392	214-275	187-212	185

① Use +90 °C (+194 °F) rated supply wire.

② Mercury vapor and metal halide luminaires are not available for purchase within the United States. Please check with your countries governing legislation regarding allowable lamp types before ordering.

Mercmaster™ III 400 Luminaire for Hazardous and Wet Locations

250 W, 400 W HPS

Listed for simultaneous exposure to combustible dusts and flammable gases or vapors.

CEC:
Class I, Division 2, Groups A, B, C, D
Class I, Zone 2, Ex nR IIC (Z)
Class II, Division 1 and 2, Groups E, F, G
Class III

CEC:
Type 4X
IP66

Type Mounting	Lamp Type	Lamp Watts	Hub Size (Inches)	With Globe	Catalog Numbers ③④⑤	
					With Type V 12" Refractor ②	With Enclosed Reflector

Pendant — One Hub, Rigid Mounting ①



Shown with Globe

HPS	250	3/4	1	KPAL2575	KPAL2575J5	KPAL2575R
			1	KPAL2510	KPAL2510J5	KPAL2510R
HPS	400	3/4	1	KPAL4075	KPAL4075J5	KPAL4075R
			1	KPAL4010	KPAL4010J5	KPAL4010R

Pendant Cone — One Hub, Rigid Mounting



Shown with 12" Glass Refractor

HPS	250	3/4	1	KPDL2575	KPDL2575J5	KPDL2575R
			1	KPDL2510	KPDL2510J5	KPDL2510R
HPS	400	3/4	1	KPDL4075	KPDL4075J5	KPDL4075R
			1	KPDL4010	KPDL4010J5	KPDL4010R

Ceiling — Five Hubs, Four Close-Up Plugs



Shown with Enclosed Reflector

HPS	250	3/4	1	KPCL2575	KPCL2575J5	KPCL2575R
			1	KPCL2510	KPCL2510J5	KPCL2510R
HPS	400	3/4	1	KPCL4075	KPCL4075J5	KPCL4075R
			1	KPCL4010	KPCL4010J5	KPCL4010R

① For Flexible Pendant Mount, change **A** to **F** in catalog number.

② To order fixture with NEMA Type II refractor, change digits **J5** in catalog number to **J2**. Refractor not available for Z, Z2 or ZB suffix.

③ For fixtures with guards, add suffix **G** before adding voltage suffix. **BG** for refractor. **NG** for enclosed reflector.

④ Add the following voltage and frequency designations before Z suffix:

Lamp Type	Lamp Watts	Voltage Suffixes						
		C2	C3	C6	C7	MT	TT	XP
HPS	250	X	X	X	X	X	X	X
HPS	400	X	X	X	X	X	X	X
PSMH	250	—	—	—	—	—	—	X
PSMH	320	—	—	—	—	X	X	X
PSMH	350	—	—	—	—	X	X	X
PSMH	400	—	—	—	—	X	X	X
MH ⑥	400	—	—	—	—	X	X	—
MH ⑥	400	X	X	X	X	X	X	—

Voltages:

C2 - 208 V 60 Hz, CWI

C3 - 240 V 60 Hz, CWI

C6 - 480 V 60 Hz, CWI

C7 - 600 V 60 Hz, CWI

LB - Incandescent, 120 V 60 Hz

MT - 120/208/240/277 V 60 Hz

TT - 120/277/347 V 60 Hz, CWA

XP - 220-240 V, 50Hz, CWA

⑤ Add **Z** for factory sealed restricted breathing protection (Ex nR)

⑥ Mercury vapor and metal halide luminaires are not available for purchase within the United States. Please check with your countries governing legislation regarding allowable lamp types before ordering.

Mercmaster™ III 400 Luminaire for Hazardous and Wet Locations

250 W, 400 W HPS

Listed for simultaneous exposure to combustible dusts and flammable gases or vapors.

CEC:
Class I, Division 2, Groups A, B, C, D
Class I, Zone 2, Ex nR IIC (Z)
Class II, Division 1 and 2, Groups E, F, G
Class III

CEC:
Type 4X
IP66

Type Mounting	Lamp Type	Lamp Watts	Hub Size (Inches)	With Globe	Catalog Numbers ③④⑤	
					With Type V 12" Refractor ②	With Enclosed Reflector

Wall Five Hubs, Four Close-Up Plugs



HPS	250	3/4	KPWL2575	KPWL2575J5	KPWL2575R
		1	KPWL2510	KPWL2510J5	KPWL2510R
HPS	400	3/4	KPWL4075	KPWL4075J5	KPWL4075R
		1	KPWL4010	KPWL4010J5	KPWL4010R

Shown with 12" Glass Refractor

25° Stanchion One Hub



HPS	250	1-1/4	KPSL25125	KPSL25125J5	KPSL25125R
		1-1/2	KPSL25150	KPSL25150J5	KPSL25150R
HPS	400	1-1/4	KPSL40125	KPSL40125J5	KPSL40125R
		1-1/2	KPSL40150	KPSL40150J5	KPSL40150R

Shown with Prismatic Glass Globe and Optional Guard

90° Stanchion One Hub



HPS	250	1-1/4	KPRL25125	KPRL25125J5	KPRL25125R
		1-1/2	KPRL25150	KPRL25150J5	KPRL25150R
HPS	400	1-1/4	KPRL40125	KPRL40125J5	KPRL40125R
		1-1/2	KPRL40150	KPRL40150J5	KPRL40150R

Shown with Prismatic Glass Globe and Optional Guard

② To order fixture with NEMA Type II refractor, change digits **J5** in catalog number to **J2**. Refractor not available for Z, Z2 or ZB suffix.

③ For fixtures with guards, add suffix **G** before adding voltage suffix. **BG** for refractor. **NG** for enclosed reflector.

④ Add the following voltage and frequency designations before Z suffix:

Lamp Type	Lamp Watts	Voltage Suffixes						
		C2	C3	C6	C7	MT	TT	XP
HPS	250	X	X	X	X	X	X	X
HPS	400	X	X	X	X	X	X	X
PSMH	250	—	—	—	—	—	—	X
PSMH	320	—	—	—	—	X	X	X
PSMH	350	—	—	—	—	X	X	X
PSMH	400	—	—	—	—	X	X	X
MH ⑥	400	—	—	—	—	X	X	—
MH ⑥	400	X	X	X	X	X	X	—

Voltages:

C2 - 208 V 60 Hz, CWI

C3 - 240 V 60 Hz, CWI

C6 - 480 V 60 Hz, CWI

C7 - 600 V 60 Hz, CWI

LB - Incandescent, 120 V 60 Hz

MT - 120/208/240/277 V 60 Hz

TT - 120/277/347 V 60 Hz, CWA

XP - 220-240 V, 50Hz, CWA

⑤ Add **Z** for factory sealed restricted breathing protection (Ex nR)

⑥ Mercury vapor and metal halide luminaires are not available for purchase within the United States. Please check with your countries governing legislation regarding allowable lamp types before ordering.



Mercmaster™ III 400 Luminaire for Hazardous and Wet Locations

250 W, 320 W, 350 W, 400 W PSMH

Listed for simultaneous exposure to combustible dusts and flammable gases or vapors.

CEC:
Class I, Division 2, Groups A, B, C, D
Class I, Zone 2, Ex nR IIC (Z)
Class II, Division 1 and 2, Groups E, F, G
Class III

CEC:
Type 4X
IP66

Type Mounting	Lamp Type	Lamp Watts	Hub Size (Inches)	Catalog Numbers ③④⑤		
				With Globe	With Type V 12" Refractor ②	With Enclosed Reflector
Pendant One Hub, Rigid Mounting ①						
 Shown with Globe	PSMH	250 ⑥	3/4	KPAP2575	KPAP2575J5	KPAP2575R
			1	KPAP2510	KPAP2510J5	KPAP2510R
	PSMH	320	3/4	KPAP3275	KPAP3275J5	KPAP3275R
			1	KPAP3210	KPAP3210J5	KPAP3210R
	PSMH	350	3/4	KPAP3575	KPAP3575J5	KPAP3575R
			1	KPAP3510	KPAP3510J5	KPAP3510R
	PSMH	400	3/4	KPAP4075	KPAP4075J5	KPAP4075R
			1	KPAP4010	KPAP4010J5	KPAP4010R
Pendant Cone One Hub, Rigid Mounting						
 Shown with 12" Glass Refractor	PSMH	250 ⑥	3/4	KPDP2575	KPDP2575J5	KPDP2575R
			1	KPDP2510	KPDP2510J5	KPDP2510R
	PSMH	320	3/4	KPDP3275	KPDP3275J5	KPDP3275R
			1	KPDP3210	KPDP3210J5	KPDP3210R
	PSMH	350	3/4	KPDP3575	KPDP3575J5	KPDP3575R
			1	KPDP3510	KPDP3510J5	KPDP3510R
	PSMH	400	3/4	KPDP4075	KPDP4075J5	KPDP4075R
			1	KPDP4010	KPDP4010J5	KPDP4010R
Ceiling Five Hubs, Four Close-Up Plugs						
 Shown with Enclosed Refractor	PSMH	250 ⑥	3/4	KPCP2575	KPCP2575J5	KPCP2575R
			1	KPCP2510	KPCP2510J5	KPCP2510R
	PSMH	320	3/4	KPCP3275	KPCP3275J5	KPCP3275R
			1	KPCP3210	KPCP3210J5	KPCP3210R
	PSMH	350	3/4	KPCP3575	KPCP3575J5	KPCP3575R
			1	KPCP3510	KPCP3510J5	KPCP3510R
	PSMH	400	3/4	KPCP4075	KPCP4075J5	KPCP4075R
			1	KPCP4010	KPCP4010J5	KPCP4010R

① For Flexible Pendant Mount, change **A** to **F** in catalog number.

② To order fixture with NEMA Type II refractor, change digits **J5** in catalog number to **J2**. Refractor not available for Z, Z2 or ZB suffix.

③ For fixtures with guards, add suffix **G** before adding voltage suffix. **BG** for refractor. **NG** for enclosed reflector.

④ Add the following voltage and frequency designations before Z suffix:

Lamp Type	Lamp Watts	Voltage Suffixes						
		C2	C3	C6	C7	MT	TT	XP
HPS	250	X	X	X	X	X	X	X
HPS	400	X	X	X	X	X	X	X
PSMH	250	—	—	—	—	—	—	X
PSMH	320	—	—	—	—	X	X	X
PSMH	350	—	—	—	—	X	X	X
PSMH	400	—	—	—	—	X	X	X
MH ⑥	400	—	—	—	—	X	X	—
MH ⑥	400	X	X	X	X	X	X	—

Voltages:
C2 - 208 V 60 Hz, CWI
C3 - 240 V 60 Hz, CWI
C6 - 480 V 60 Hz, CWI
C7 - 600 V 60 Hz, CWI
LB - Incandescent, 120 V 60 Hz
MT - 120/208/240/277 V 60 Hz
TT - 120/277/347 V 60 Hz, CWA
XP - 220-240 V, 50Hz, CWA

⑤ Add **Z** for factory sealed restricted breathing protection (Ex nR)

⑥ Mercury vapor and metal halide luminaires are not available for purchase within the United States. Please check with your countries governing legislation regarding allowable lamp types before ordering.



Mercmaster™ III 400 Luminaire for Hazardous and Wet Locations

250 W, 320 W, 350 W, 400 W PSMH

Listed for simultaneous exposure to combustible dusts and flammable gases or vapors.

CEC:
Class I, Division 2, Groups A, B, C, D
Class I, Zone 2, Ex nR IIC (Z)
Class II, Division 1 and 2, Groups E, F, G
Class III

CEC:
Type 4X
IP66

Type Mounting	Lamp Type	Lamp Watts	Hub Size (Inches)	With Globe	Catalog Numbers ③④⑤		
					With Type V 12" Refractor ②	With Enclosed Reflector	
Wall Five Hubs, Four Close-Up Plugs							
	PSMH	250 ⑥	3/4	KPWP2575	KPWP2575J5	KPWP2575R	
			1	KPWP2510	KPWP2510J5	KPWP2510R	
	PSMH	320	3/4	KPWP3275	KPWP3275J5	KPWP3275R	
			1	KPWP3210	KPWP3210J5	KPWP3210R	
	PSMH	350	3/4	KPWP3575	KPWP3575J5	KPWP3575R	
			1	KPWP3510	KPWP3510J5	KPWP3510R	
	PSMH	400	3/4	KPWP4075	KPWP4075J5	KPWP4075R	
			1	KPWP4010	KPWP4010J5	KPWP4010R	
25° Stanchion One Hub							
	PSMH	250 ⑥	1-1/4	KPSP25125	KPSP25125J5	KPSP25125R	
			1-1/2	KPSP25150	KPSP25150J5	KPSP25150R	
	PSMH	320	1-1/4	KPSP32125	KPSP32125J5	KPSP32125R	
			1-1/2	KPSP32150	KPSP32150J5	KPSP32150R	
	PSMH	350	1-1/4	KPSP35125	KPSP35125J5	KPSP35125R	
			1-1/2	KPSP35150	KPSP35150J5	KPSP35150R	
	PSMH	400	1-1/4	KPSP40125	KPSP40125J5	KPSP40125R	
			1-1/2	KPSP40150	KPSP40150J5	KPSP40150R	
90° Stanchion One Hub							
	PSMH	250 ⑥	1-1/4	KPRP25125	KPRP25125J5	KPRP25125R	
			1-1/2	KPRP25150	KPRP25150J5	KPRP25150R	
	PSMH	320	1-1/4	KPRP32125	KPRP32125J5	KPRP32125R	
			1-1/2	KPRP32150	KPRP32150J5	KPRP32150R	
	PSMH	350	1-1/4	KPRP35125	KPRP35125J5	KPRP35125R	
			1-1/2	KPRP35150	KPRP35150J5	KPRP35150R	
	PSMH	400	1-1/4	KPRP40125	KPRP40125J5	KPRP40125R	
			1-1/2	KPRP40150	KPRP40150J5	KPRP40150R	

Shown with 12" Glass Refractor

25° Stanchion One Hub

Shown with Prismatic Glass Globe and Optional Guard

90° Stanchion One Hub

Shown with Prismatic Glass Globe and Optional Guard

② To order fixture with NEMA Type II refractor, change digits J5 in catalog number to J2. Refractor not available for Z, Z2 or ZB suffix.

③ For fixtures with guards, add suffix G before adding voltage suffix. BG for refractor. NG for enclosed reflector.

④ Add the following voltage and frequency designations before Z suffix:

Lamp Type	Lamp Watts	Voltage Suffixes							
		C2	C3	C6	C7	MT	TT	XP	
HPS	250	X	X	X	X	X	X	X	
HPS	400	X	X	X	X	X	X	X	
PSMH	250	—	—	—	—	—	—	X	
PSMH	320	—	—	—	—	X	X	X	
PSMH	350	—	—	—	—	X	X	X	
PSMH	400	—	—	—	—	X	X	X	
MH ⑥	400	—	—	—	—	X	X	—	
MH ⑥	400	X	X	X	X	X	X	—	

Voltages:

C2 - 208 V 60 Hz, CWI

C3 - 240 V 60 Hz, CWI

C6 - 480 V 60 Hz, CWI

C7 - 600 V 60 Hz, CWI

LB - Incandescent, 120 V 60 Hz

MT - 120/208/240/277 V 60 Hz

TT - 120/277/347 V 60 Hz, CWA

XP - 220-240 V, 50Hz, CWA

⑤ Add Z for factory sealed restricted breathing protection (Ex nR)

⑥ Mercury vapor and metal halide luminaires are not available for purchase within the United States. Please check with your countries governing legislation regarding allowable lamp types before ordering.

Mercmaster™ III 400 Luminaire for Hazardous and Wet Locations

400 W MH

Listed for simultaneous exposure to combustible dusts and flammable gases or vapors.

CEC:
Class I, Division 2, Groups A, B, C, D
Class I, Zone 2, Ex nR IIC (Z)
Class II, Division 1 and 2, Groups E, F, G
Class III

CEC:
Type 4X
IP66

Type Mounting	Lamp Type ⑥	Lamp Watts	Hub Size (Inches)	With Globe	Catalog Numbers ③④⑤		
					With Type V 12" Refractor ②	With Enclosed Reflector	

Pendant One Hub, Rigid Mounting ①



Shown with Globe

MH	400	3/4	KPAH4075	KPAH4075J5	KPAH4075R
		1	KPAH4010	KPAH4010J5	KPAH4010R

Pendant Cone One Hub, Rigid Mounting



Shown with 12" Glass Refractor

MH	400	3/4	KPDH4075	KPDH4075J5	KPDH4075R
		1	KPDH4010	KPDH4010J5	KPDH4010R

Ceiling Five Hubs, Four Close-Up Plugs



Shown with Enclosed Refractor

MH	400	3/4	KPCH4075	KPCH4075J5	KPCH4075R
		1	KPCH4010	KPCH4010J5	KPCH4010R

① For Flexible Pendant Mount, change **A** to **F** in catalog number.

② To order fixture with NEMA Type II refractor, change digits **J5** in catalog number to **J2**. Refractor not available for Z, Z2 or ZB suffix.

③ For fixtures with guards, add suffix **G** before adding voltage suffix. **BG** for refractor. **NG** for enclosed reflector.

④ Add the following voltage and frequency designations before Z suffix:

Lamp Type	Lamp Watts	Voltage Suffixes						
		C2	C3	C6	C7	MT	TT	XP
HPS	250	X	X	X	X	X	X	X
HPS	400	X	X	X	X	X	X	X
PSMH	250	—	—	—	—	—	—	X
PSMH	320	—	—	—	—	X	X	X
PSMH	350	—	—	—	—	X	X	X
PSMH	400	—	—	—	—	X	X	X
MH ⑥	400	—	—	—	—	X	X	—
MH ⑥	400	X	X	X	X	X	X	—

Voltages:

C2 - 208 V 60 Hz, CWI

C3 - 240 V 60 Hz, CWI

C6 - 480 V 60 Hz, CWI

C7 - 600 V 60 Hz, CWI

LB - Incandescent, 120 V 60 Hz

MT - 120/208/240/277 V 60 Hz

TT - 120/277/347 V 60 Hz, CWA

XP - 220-240 V, 50Hz, CWA

⑤ Add **Z** for factory sealed restricted breathing protection (Ex nR)

⑥ Mercury vapor and metal halide luminaires are not available for purchase within the United States. Please check with your countries governing legislation regarding allowable lamp types before ordering.

Mercmaster™ III 400 Luminaire for Hazardous and Wet Locations

400 W MH

Listed for simultaneous exposure to combustible dusts and flammable gases or vapors.

CEC:
 Class I, Division 2, Groups A, B, C, D
 Class I, Zone 2, Ex nR IIC (Z)
 Class II, Division 1 and 2, Groups E, F, G
 Class III

CEC:
 Type 4X
 IP66

Type Mounting	Lamp Type ⑥	Lamp Watts	Hub Size (Inches)	With Globe	Catalog Numbers ③④⑤		
					With Type V 12" Refractor ②	With Enclosed Reflector	

Wall Five Hubs, Four Close-Up Plugs



MH	400	3/4 1	KPWH4075	KPWH4075J5	KPWH4075R
			KPWH4010	KPWH4010J5	KPWH4010R

Shown with 12" Glass Refractor

25° Stanchion One Hub



MH	400	1-1/4	KPSH40125	KPSH40125J5	KPSH40125R
		1-1/2	KPSH40150	KPSH40150J5	KPSH40150R

Shown with Prismatic Glass Globe and Optional Guard

90° Stanchion One Hub



MH	400	1-1/4	KPRH40125	KPRH40125J5	KPRH40125R
		1-1/2	KPRH40150	KPRH40150J5	KPRH40150R

Shown with Prismatic Glass Globe and Optional Guard

② To order fixture with NEMA Type II refractor, change digits **J5** in catalog number to **J2**. Refractor not available for Z, Z2 or ZB suffix.

③ For fixtures with guards, add suffix **G** before adding voltage suffix. **BG** for refractor. **NG** for enclosed reflector.

④ Add the following voltage and frequency designations before Z suffix:

Lamp Type	Lamp Watts	Voltage Suffixes							
		C2	C3	C6	C7	MT	TT	XP	
HPS	250	X	X	X	X	X	X	X	
HPS	400	X	X	X	X	X	X	X	
PSMH	250	—	—	—	—	—	—	X	
PSMH	320	—	—	—	—	X	X	X	
PSMH	350	—	—	—	—	X	X	X	
PSMH	400	—	—	—	—	X	X	X	
MH	400	—	—	—	—	X	X	—	
MH	400	X	X	X	X	X	X	—	

Voltages:

C2 - 208 V 60 Hz, CWI

C3 - 240 V 60 Hz, CWI

C6 - 480 V 60 Hz, CWI

C7 - 600 V 60 Hz, CWI

LB - Incandescent, 120 V 60 Hz

MT - 120/208/240/277 V 60 Hz

TT - 120/277/347 V 60 Hz, CWA

XP - 220-240 V, 50Hz, CWA

⑤ Add **Z** for factory sealed restricted breathing protection (Ex nR)

⑥ Mercury vapor and metal halide luminaires are not available for purchase within the United States. Please check with your countries governing legislation regarding allowable lamp types before ordering.

Mercmaster™ III 400 Luminaire for Hazardous and Wet Locations







High Pressure Sodium, Pulse Start Metal Halide and Metal Halide - Hazardous and Wet Locations

Listed for simultaneous exposure to combustible dusts and flammable gases or vapors.

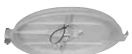
CEC:
Class I, Division 2, Groups A, B, C, D
Class I, Zone 2, Ex nR IIC (Z)
Class II, Division 1 and 2, Groups E, F, G
Class III

CEC:
Type 4X
IP66

Mounting Hoods

	Description	Hub Size (Inches)	Catalog Number
Pendant 	One Hub, Rigid Mounting	3/4	KPA-75
		1	KPA-100
Pendant – Flexible 	One Hub, Flexible Mounting	3/4	KPAF-75
		1	KPAF-100
Pendant Cone 	One Hub, Rigid	3/4	KPCH-75
		1	KPCH-100
Ceiling 	Five Hubs, Four Close-Up Plugs	3/4	KPC-75
		1	KPC-100
Wall 	Five Hubs, Four Close-Up Plugs	3/4	KPWB-75
		1	KPWB-100
25° Stanchion 	One Hub	1-1/4	KPS-125
		1-1/2	KPS-150
90° Stanchion 	One Hub	1-1/4	KPST-125
		1-1/2	KPST-150

Ballast Bodies



High Pressure Sodium – Constant Wattage (Min. P.F. 90%)
Pulse Start Metal Halide – Super Constant Wattage (Min. P.F. 90%)

Lamp Type	Lamp Watts	Catalog Numbers ②	Voltage Suffixes						
			C2	C3	C6	C7	MT	TT	XP
HPS	250	KPB250L ①③	X	X	X	X	X	X	X
HPS	400	KPB400L ①③	X	X	X	X	X	X	X
PSMH	250	KPB250P ①③④	–	–	–	–	–	–	X
PSMH	320	KPB320P ①③	–	–	–	–	X	X	X
PSMH	350	KPB350P ①③	–	–	–	–	X	X	X
PSMH	400	KPB400P ①③	–	–	–	–	X	X	X
MH ⑤	400	KPB400H	X	X	X	X	X	X	–

Voltages:

C2 - 208, 60 Hz, CWI
C3 - 240, 60 Hz, CWI

C6 - 480, 60 Hz, CWI

C7 - 600, 60 Hz, CWI

MT - 120/208/240/277, 60 Hz

TT - 120/277/347, 60 Hz

XP - 220-240, 50 Hz

① Add **-S** after voltage designation for ballast body with Smart Starter (HPS and PSMH only).

② Add **-E** after voltage designation for ballast body with provision for Quartz Emergency Light (not suitable for hazardous location).

③ Add **Z** for factory sealed restricted breathing protection (Ex nR).

④ Not available in MT. See Mercmaster III 50-250 Luminaires.

⑤ Mercury vapor and metal halide luminaires are not available for purchase within the United States. Please check with your countries governing legislation regarding allowable lamp types before ordering.

Visit our website at www.emerson.com or contact us at (800) 621-1506.

© May 2016

Appleton®

HID/AREA: NEC/CEC ENCLOSED AND GASKETED

Mercmaster™ III 400 Luminaire for Hazardous and Wet Locations

High Pressure Sodium, Pulse Start Metal Halide and Metal Halide - Hazardous and Wet Locations

Listed for simultaneous exposure to combustible dusts and flammable gases or vapors.

CEC:
 Class I, Division 2, Groups A, B, C, D
 Class I, Zone 2, Ex nR IIC (Z)
 Class II, Division 1 and 2, Groups E, F, G
 Class III

CEC:
 Type 4X
 IP66

Description	Catalog Number
-------------	----------------

Prismatic Glass Globes — Heat-Resistant



Glass Globe

Clear

VPGL-4HR

Enclosed Reflector Assembly



Enclosed Reflector

Heat- and impact-resistant glass lens

KPR-4HB

Light Distribution	IES/NEMA Distribution Curves	Catalog Number
--------------------	------------------------------	----------------

Closed Prismatic Glass Refractors ② — All Heat-Resistant



Glass Refractor

NEMA Type II

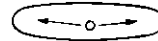

KPRF400-2

NEMA Type V



KPRF400-5

Item	Description	Catalog Number
------	-------------	----------------

White Polyester Reflectors



Standard and Deep Dome



30° Angle

For use with globe fixtures

Standard Dome

CMR-4ST①

30° Angle

CMR-4AN

Deep Dome

CMR-4DD①

Guards



Globe Guard



Refractor Guard



Enclosed Refractor Guard

Globe Guard

KPGU400

Refractor Guard

KPBG12

Enclosed Refractor Guard

G-HB7000-NG

① Contact your local sales representative if used with KPWB or KPST mounting hoods.

② Not suitable for use with Z suffix (Zone 2).

Mercmaster™ III 400 Luminaire for Hazardous and Wet Locations

High Pressure Sodium, Pulse Start Metal Halide and Metal Halide - Hazardous and Wet Locations

Listed for simultaneous exposure to combustible dusts and flammable gases or vapors.

CEC:
 Class I, Division 2, Groups A, B, C, D
 Class I, Zone 2, Ex nR IIC (Z)
 Class II, Division 1 and 2, Groups E, F, G
 Class III

CEC:
 Type 4X
 IP66

Electrical Specifications

Line Voltage	Type of Ballast ①	Frequency	Starting Amps	Operating Amps	Total Watts
250 Watt High Pressure Sodium					
120	C.W.A.	60	2.00	2.50	295
208	C.W.A.	60	1.20	1.50	295
240	C.W.A.	60	1.00	1.30	295
277	C.W.A.	60	0.85	1.10	295
347	C.W.A.	60	0.60	0.93	295
480	C.W.A.	60	0.40	0.65	295
120	C.W.A.	50	1.85	2.75	300
230	C.W.A.	50	0.95	1.44	300
400 Watt High Pressure Sodium					
120	C.W.A.	60	3.30	3.80	465
208	C.W.A.	60	1.80	2.20	465
240	C.W.A.	60	1.60	1.90	465
277	C.W.A.	60	1.40	1.70	465
347	C.W.A.	60	1.00	1.32	464
480	C.W.A.	60	0.80	1.00	465
120	C.W.A.	50	3.70	4.00	465
230	C.W.A.	50	1.85	2.00	465
250 Watt Pulse Start Metal Halide					
120	C.W.A.	60	1.96	2.50	291
208	C.W.A.	60	1.13	1.45	291
240	C.W.A.	60	0.98	1.25	291
277	C.W.A.	60	0.85	1.10	291
347	C.W.A.	60	0.62	0.90	291
480	C.W.A.	60	0.32	0.69	298
480	Super C.W.A.	60	0.45	0.60	285
120	Super C.W.A.	50	1.90	2.60	288
230	Super C.W.A.	50	1.00	1.35	288
320 Watt Pulse Start Metal Halide					
120	Super C.W.A.	60	2.60	3.25	368
208	Super C.W.A.	60	1.50	1.90	368
240	Super C.W.A.	60	1.30	1.65	368
277	Super C.W.A.	60	1.15	1.40	368
347	Super C.W.A.	60	0.70	1.10	368
480	Super C.W.A.	60	0.60	0.80	368
120	Super C.W.A.	50	2.28	3.05	365
230	Super C.W.A.	50	1.14	1.60	365
350 Watt Pulse Start Metal Halide					
120	Super C.W.A.	60	3.30	3.60	400
208	Super C.W.A.	60	1.90	2.10	400
240	Super C.W.A.	60	1.65	1.80	400
277	Super C.W.A.	60	1.40	1.55	400
347	Super C.W.A.	60	0.85	1.20	400
480	Super C.W.A.	60	0.75	0.90	400
120	Super C.W.A.	50	2.45	3.34	394
230	Super C.W.A.	50	1.26	1.74	394

Electrical Specifications

Line Voltage	Type of Ballast ①	Frequency	Starting Amps	Operating Amps	Total Watts
400 Watt Pulse Start Metal Halide					
120	Super C.W.A.	60	3.50	4.00	454
208	Super C.W.A.	60	2.00	2.30	454
240	Super C.W.A.	60	1.75	2.00	454
277	Super C.W.A.	60	1.50	1.25	454
347	Super C.W.A.	60	1.10	1.35	452
480	Super C.W.A.	60	0.90	1.00	454
120	Super C.W.A.	50	3.17	3.90	454
230	Super C.W.A.	50	1.65	2.00	454
400 Watt Metal Halide ②					
120	C.W.A.	60	3.25	4.00	458
208	C.W.A.	60	1.90	2.30	458
240	C.W.A.	60	1.80	2.00	458
277	C.W.A.	60	1.70	1.75	458
347	C.W.A.	60	1.40	1.75	458
480	C.W.I.	60	0.85	1.00	462
600	C.W.I.	60	0.30	0.70	475
120	C.W.A.	50	2.70	4.10	462
220	C.W.A.	50	1.50	2.10	462
240	C.W.A.	50	1.50	2.10	462

① C.W.A. – Constant Wattage Autotransformer. HX-HPF – High Reactance High Power Factor Autotransformer.
 Super C.W.A. – Super Constant Wattage Autotransformer.

② Mercury vapor and metal halide luminaires are not available for purchase within the United States. Please check with your countries governing legislation regarding allowable lamp types before ordering.

Mercmaster™ III 400 Luminaire for Hazardous and Wet Locations

High Pressure Sodium, Pulse Start Metal Halide and Metal Halide - Hazardous and Wet Locations

Listed for simultaneous exposure to combustible dusts and flammable gases or vapors.

CEC:
 Class I, Division 2, Groups A, B, C, D
 Class I, Zone 2, Ex nR IIC (Z)
 Class II, Division 1 and 2, Groups E, F, G
 Class III

CEC:
 Type 4X
 IP66

Dimensions in Millimeters (Inches)

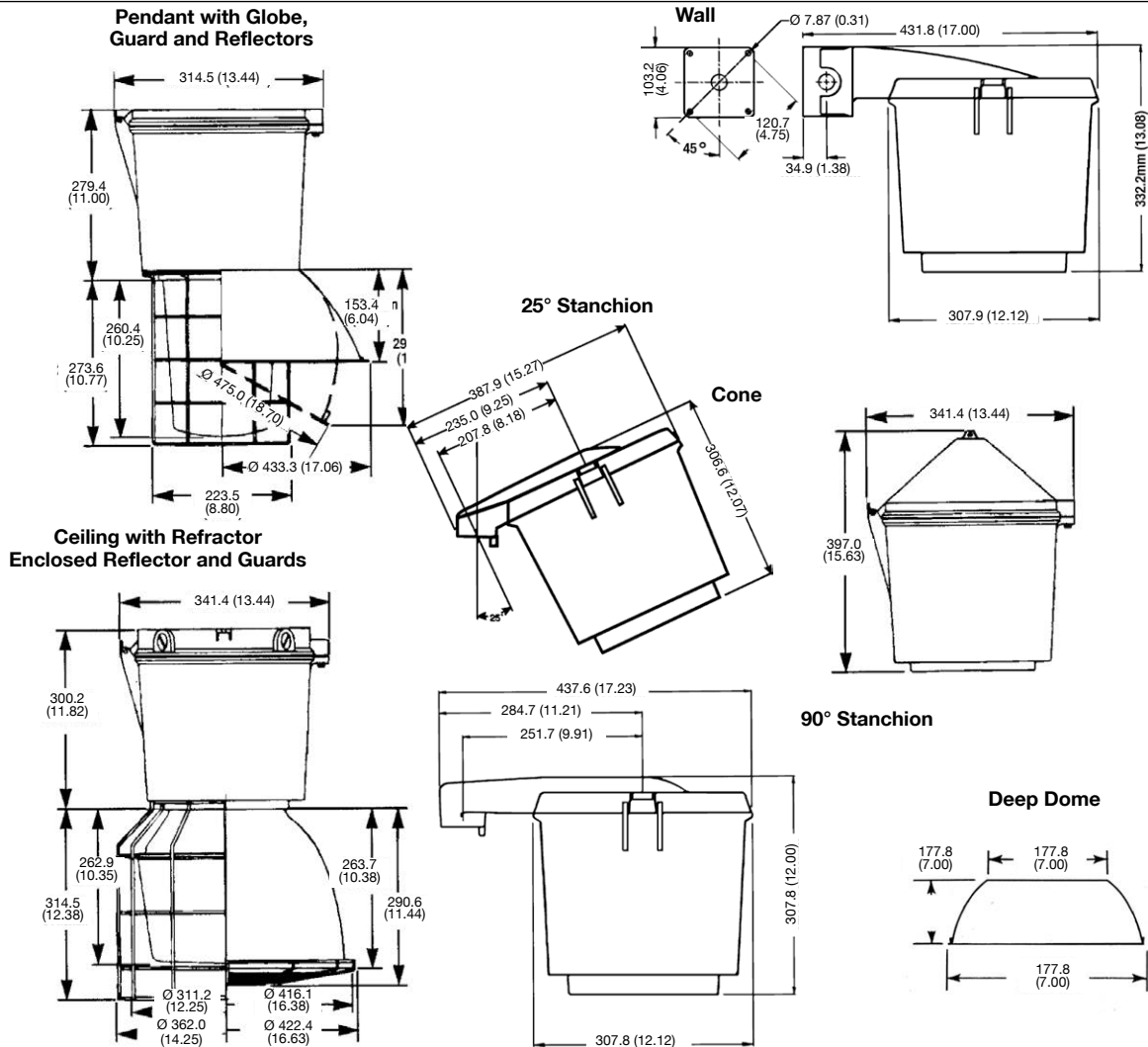

Mercmaster III – 400 Ballast and Accessory Weights

Lamp Watts	Ballast Housing Wt. kg (lb)		Mounting Hoods and Reflectors	Wt. kg (lb)	Globe Refractor, Enclosed Reflector and Guards	
	HPS	PSMH			Reflector and Guards	Wt. kg (lb)
250	11.1 (24.5)	—	Pendant	1.0 (2.25)	Glass Globe	3.2 (7.0)
			Pendant Cone	1.1 (2.50)	Globe Guard	1.4 (3.0)
320	—	12.7 (28.0)	Ceiling	1.4 (3.00)	12" Glass Refractor	5.4 (12.0)
			Wall	1.8 (4.00)	Refractor Guard	2.0 (4.5)
350	—	12.9 (28.5)	25° Stanchion	1.5 (3.25)	Enclosed Reflector	5.0 (11.0)
			90° Stanchion	1.7 (3.75)	Enclosed Reflector Guard	0.9 (2.0)
400	12.9 (28.5)	12.9 (28.5)	Standard Dome	1.6 (3.50)		
			30° Angle	1.6 (3.50)		

Weights are approximate. Add 0.11 kg (0.25 lb). for Quartz option.

PCD2 Series Factory Sealed Hazardous Location Photocontrol

For use in Class I, Division 2, Groups A, B, C, D locations

Maintains Class I, Division 2 rating for Mercmaster III – Low Profile, Mercmaster III, and Mercmaster III – 400 Series Luminaires, Mercmaster LED

NEC/CEC:
Class I, Division 2, Groups A, B, C, D
NEMA 4X

Applications

- Encapsulated photocontrol provides automatic dusk-to-dawn lighting control in Class I, Division 2 locations.
- Typical applications include walkways, security areas and any other outdoor lighting application.
- For use with Mercmaster III – Low Profile, Mercmaster III, and Mercmaster III – 400 Series Luminaires.
- For remote mounting in FS Boxes.

- 50-400 W HID, incandescent or fluorescent, 50/60 Hz.
- 1000 V.A. Voltage/Ampere
- Minimum time delay: 15 seconds to eliminate nuisance tripping.
- Provided with (3) 18AWG stranded leads 152.4 mm (6 in) in length.
- Will fit through standard 1/2" knockout.
- Supplied with locknut and gasket.

Features



- Factory sealed design eliminates the need for an explosionproof enclosure.
- Can be easily installed in the field.
- Solid state design for performance and reliability.
- Available for 120, 208, 240, or 277 volts.

Materials

- Encapsulated with epoxy sealing compound
- FS: aluminum

NEC/CEC Certifications and Compliances

- UL Standard: 1604 – Hazardous (Classified) Locations
- cULus Recognized

	Voltage Range	Max VA	Max Current Amps	Suffix Designation Catalog Number
Factory-Installed Photocontrol - Not for ceiling or pendant cone.				
<i>Add to fixture catalog after voltage; i.e.: KPWBL1075MTH1.</i>				
	120 V, 50/60 Hz	1000	—	H1
	208 V, 50/60 Hz	1000	—	H2
	240 V, 50/60 Hz	1000	—	H3
	277 V, 50/60 Hz	1000	—	H4
Photocontrol for Field Installation				
	120 V, 50/60 Hz	1000	8.3 Amp	PC120D2
	208 V, 50/60 Hz	1000	4.8 Amp	PC247D2
	240 V, 50/60 Hz	1000	4.2 Amp	
	277 V, 50/60 Hz	1000	3.6 Amp	
Photocontrol in FS Cover for Use with FS/FD Box				
<i>Supplied with two stainless steel screws. For neoprene gasket, order catalog number FS-GKR-1N.</i>				
	120 V, 50/60 Hz	1000	8.3 Amp	FSKA-PC120D2
	208, 50/60 Hz	1000	4.8 Amp	FSKA-PC247D2
	240 V, 50/60 Hz	1000	4.2 Amp	
	277 V, 50/60 Hz	1000	3.6 Amp	

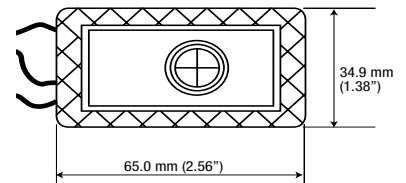
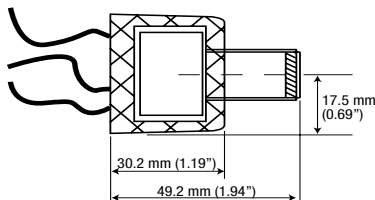
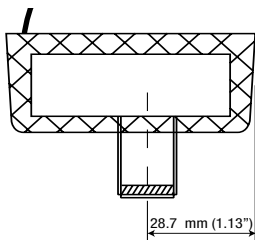

Mercmaster™ III 400 Luminaire for Hazardous and Wet Locations

400 W PSMH

* Photometric data is based on a fixture with a 400-watt clear Pulse Start Metal Halide lamp (44,000 lumen). For candlepower values of fixtures with other PSMH lamps, use the following multipliers: for a 320 W (33,000 lumen) PSMH lamp – .750; for a 350 W (37,000 lumen) PSMH lamp – .840. For candlepower values of fixture with guard, multiply by – 0.95.

CEC:
 Class I, Division 2, Groups A, B, C, D
 Class I, Zone 2, Ex nR IIC (Z)
 Class II, Division 1 and 2, Groups E, F, G
 Class III

CEC:
 Type 4X
 IP66

Photometric Data

Zone Lumens TOTAL LUMINAIRE EFFICIENCY = 92.6%

CIE Type – General Diffuse

0-10	118.85
10-20	488.36
20-30	948.99
30-40	1678.84
40-50	2714.15
50-60	3299.55
60-70	3919.47
70-80	4497.45
80-90	4892.41
90-100	4803.79
100-110	4404.56
110-120	3849.71
120-130	3078.18
130-140	1852.83
140-150	185.86
150-160	14.88
160-170	1.78
170-180	0.12

ZONAL LUMEN SUMMARY

Zone	Lumens	% Lamp	% Fixture
0-30	1556.19	3.5	3.8
0-40	3235.03	7.4	7.9
0-60	9248.74	21.0	22.7
0-90	22558.07	51.3	55.4
90-120	13058.07	29.7	32.0
90-130	16136.25	36.7	39.6
90-150	18174.93	41.3	44.6
90-180	18191.71	41.3	44.6
0-180	40749.78	92.6	100.0

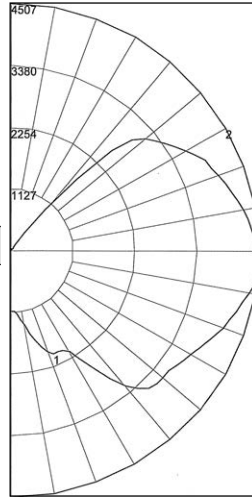

REPORT NUMBER: **KP40PG**

Lamps: 400 W Pulse Start Metal Halide with Globe *

Coefficients of Utilization – Zonal Cavity Method

Effective Floor Cavity Reflectance 0.20

% Ceiling	Rcc	80				70				50				30				10				0
		70	50	30	10	70	50	30	10	50	30	10	50	30	10	50	30	10	0			
0	100	100	100	100	100	93	93	93	93	80	80	80	68	68	68	57	57	57	57	0		
1	86	80	74	69	79	73	68	64	62	58	54	51	48	45	41	39	37	32	32	0		
2	76	67	59	52	70	61	54	48	51	45	41	42	37	33	33	30	27	22	22	0		
3	68	57	48	41	62	52	44	38	45	37	32	35	30	26	28	24	20	16	16	0		
4	62	49	40	33	56	45	37	30	37	31	26	30	25	21	24	20	16	13	13	0		
5	56	43	34	27	51	40	31	25	33	26	21	27	21	17	21	17	13	10	10	0		
6	51	38	29	23	47	35	27	21	29	23	18	24	18	14	18	14	11	8	8	0		
7	47	34	25	20	43	31	24	18	26	20	15	21	16	12	17	12	9	7	7	0		
8	44	31	22	17	40	28	21	16	24	17	13	19	14	10	15	11	8	6	6	0		
9	41	28	20	15	37	26	18	14	21	15	11	18	13	9	14	10	7	5	5	0		
10	38	25	18	13	35	23	16	12	20	14	10	16	11	8	13	9	6	4	4	0		

Zone Lumens TOTAL LUMINAIRE EFFICIENCY = 81.4%

CIE Type – Direct

0-10	561.93
10-20	1748.92
20-30	2859.54
30-40	4018.21
40-50	5254.58
50-60	5772.38
60-70	6052.84
70-80	5887.04
80-90	3512.71
90-100	137.17
100-110	0.00
110-120	0.00
120-130	0.00
130-140	0.00
140-150	0.00
150-160	0.00
160-170	0.00
170-180	0.00

Plane	Spacing Criteria
0-180	1.76
90-270	1.76
Diagonal	1.86

ZONAL LUMEN SUMMARY

Zone	Lumens	% Lamp	% Fixture
0-30	5170.39	11.8	14.4
0-40	9188.60	20.9	25.7
0-60	20215.55	45.9	56.5
0-90	35668.14	81.1	99.6
90-120	137.17	0.3	0.4
90-130	137.17	0.3	0.4
90-150	137.17	0.3	0.4
90-180	137.17	0.3	0.4
0-180	35805.32	81.4	100.0

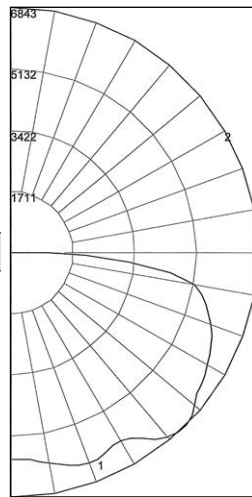

REPORT NUMBER: **KP40PST**

Lamps: 400 W Pulse Start Metal Halide with Standard Dome Reflector *

Coefficients of Utilization – Zonal Cavity Method

Effective Floor Cavity Reflectance 0.20

% Ceiling	Rcc	80				70				50				30				10				0
		70	50	30	10	70	50	30	10	50	30	10	50	30	10	50	30	10	0			
0	97	97	97	97	95	95	95	95	90	90	90	86	86	86	83	83	83	81	81	0		
1	84	78	73	68	81	76	71	67	72	69	65	69	66	63	66	63	61	59	59	0		
2	74	65	58	51	72	63	57	51	60	54	49	57	52	48	55	51	47	45	45	0		
3	66	55	47	40	64	54	46	40	51	44	39	49	43	38	46	42	37	35	35	0		
4	60	48	39	32	58	47	39	32	44	37	32	42	36	31	40	35	31	28	28	0		
5	55	42	33	27	53	41	33	27	39	32	26	37	31	26	36	30	26	24	24	0		
6	50	37	29	23	48	36	28	23	35	28	22	33	27	22	32	26	22	20	20	0		
7	46	33	25	20	44	33	25	19	31	24	19	30	24	19	29	23	19	17	17	0		
8	43	30	22	17	41	30	22	17	28	22	17	27	21	17	26	21	17	15	15	0		
9	40	28	20	15	38	27	20	15	26	19	15	25	19	15	24	19	15	13	13	0		
10	37	25	18	13	36	25	18	13	24	18	13	23	17	13	22	17	13	12	12	0		

Mercmaster™ III 400 Luminaire for Hazardous and Wet Locations

400 W PSMH

* Photometric data is based on a fixture with a 400-watt clear Pulse Start Metal Halide lamp (44,000 lumen). For candlepower values of fixtures with other PSMH lamps, use the following multipliers: for a 320 W (33,000 lumen) PSMH lamp – .750; for a 350 W (37,000 lumen) PSMH lamp – .840. For candlepower values of fixture with guard, multiply by – 0.95.

CEC:

Class I, Division 2, Groups A, B, C, D
Class I, Zone 2, Ex nR IIC (Z)
Class II, Division 1 and 2, Groups E, F, G
Class III

CEC:

Type 4X
IP66

Photometric Data

Zone Lumens TOTAL LUMINAIRE EFFICIENCY = 76%

Zone	Lumens	CIE Type – Direct	
		Plane	Spacing Criteria
0-10	499.96		
10-20	1605.38		
20-30	2680.72		
30-40	3841.49	0-180	2.28
40-50	4899.23	90-270	1.92
50-60	4819.21	Diagonal	1.84
60-70	4564.58		
70-80	4063.65		
80-90	3258.13		

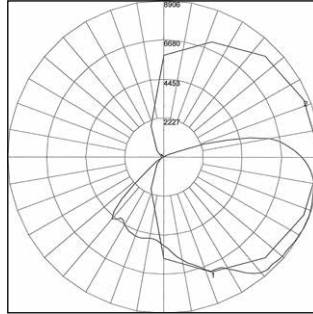

REPORT NUMBER: **KP40PAN**

Lamps: 400 W Pulse Start Metal Halide with 30° Angle Dome Reflector *

Coefficients of Utilization – Zonal Cavity Method

Effective Floor Cavity Reflectance 0.20

% Ceiling	Rcc	80				70				50				30				10				0
		70	50	30	10	70	50	30	10	50	30	10	50	30	10	50	30	10				
% Walls	Rw																					
	0	89	89	89	89	86	86	86	86	80	80	80	75	75	75	71	71	71	69			
	1	78	72	68	64	75	70	66	62	65	62	59	61	58	56	57	55	53	50			
	2	69	61	55	49	66	59	53	48	55	50	46	51	47	43	48	44	41	39			
	3	62	52	45	39	59	51	44	38	47	41	37	44	39	35	41	37	33	31			
	4	56	46	38	32	54	44	37	31	41	35	30	38	33	29	36	31	28	26			
	5	51	40	33	27	49	39	32	26	36	30	25	34	29	24	32	27	23	21			
	6	47	36	28	23	45	35	28	22	32	26	22	30	25	21	29	24	20	18			
	7	43	32	25	20	42	31	24	19	29	23	19	27	22	18	26	21	17	16			
	8	40	29	22	17	39	28	22	17	27	21	16	25	20	16	24	19	15	14			
	9	37	26	20	15	36	26	19	15	24	19	15	23	18	14	22	17	14	12			
	10	35	24	18	14	34	24	17	13	22	17	13	21	16	13	20	15	12	11			

ZONAL LUMEN SUMMARY

Zone	Lumens	% Lamp	% Fixture
100-110	762.24		
110-120	138.12	0-30	4786.06 10.9 14.3
120-130	77.59	0-40	8627.55 19.6 25.8
130-140	73.07	0-60	18345.99 41.7 54.9
140-150	25.07	0-90	30232.35 68.7 90.4
150-160	10.91	90-120	3005.49 6.8 9.0
160-170	5.30	90-130	3083.09 7.0 9.2
170-180	1.45	90-150	3181.23 7.2 9.5
		90-180	3198.89 7.3 9.6
		0-180	33431.25 76.0 100.0



HID/AREA: NEC/CEC ENCLOSED AND GASKETED

Mercmaster™ III 400 Luminaire for Hazardous and Wet Locations

400 W PSMH

* Photometric data is based on a fixture with a 400-watt clear Pulse Start Metal Halide lamp (44,000 lumen). For candlepower values of fixtures with other PSMH lamps, use the following multipliers: for a 320 W (33,000 lumen) PSMH lamp – .750; for a 350 W (37,000 lumen) PSMH lamp – .840. For candlepower values of fixture with guard, multiply by – 0.95.

CEC:
 Class I, Division 2, Groups A, B, C, D
 Class I, Zone 2, Ex nR IIC (Z)
 Class II, Division 1 and 2, Groups E, F, G
 Class III

CEC:
 Type 4X
 IP66

Photometric Data

Zone Lumens TOTAL LUMINAIRE EFFICIENCY = 78.4%

Zone	Lumens	TOTAL LUMINAIRE EFFICIENCY = 78.4%		
0-10	77.24	CIE Type – Semi-Direct		
10-20	575.14	Plane	Spacing Criteria	
20-30	1061.45			
30-40	1581.40	0-180	1.36	
40-50	4468.52	90-270	1.40	
50-60	4938.88	Diagonal	2.42	
60-70	6338.26	ZONAL LUMEN SUMMARY		
70-80	5875.90			
80-90	3886.90	Zone	Lumens	% Lamp % Fixture
90-100	1318.17	0-30	1713.83	3.9 5.0
100-110	1872.98	0-40	3295.23	7.5 9.6
110-120	1122.17	0-60	12702.64	28.9 36.8
120-130	616.83	0-90	28803.69	65.5 83.5
130-140	358.56	90-120	4313.33	9.8 12.5
140-150	224.03	90-130	4930.15	11.2 14.3
150-160	128.38	90-150	5512.75	12.5 16.0
160-170	50.79	90-180	5699.61	13.0 16.5
170-180	7.69	0-180	34503.3	78.4 100.0

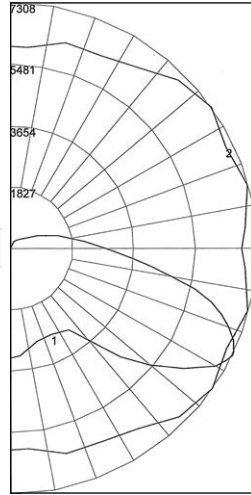

REPORT NUMBER: **KP40PJ5**

Lamps: 400 W Pulse Start Metal Halide with
 8" Prismatic Glass Refractor – NEMA Type V *

Coefficients of Utilization – Zonal Cavity Method

Effective Floor Cavity Reflectance 0.20

% Floors Rfc	% Ceiling Rcc	% Walls Rw	20															
			80			70			50			30			10			0
0	90	90	90	90	87	87	87	87	80	80	80	74	74	74	68	68	68	65
1	77	71	66	61	73	68	63	59	62	58	54	57	53	50	52	49	47	44
2	67	58	50	44	64	55	48	42	50	44	39	45	41	37	41	37	34	31
3	59	48	40	33	56	46	38	32	42	35	30	38	32	27	34	29	25	23
4	53	41	33	26	50	39	31	25	35	29	23	32	26	21	29	24	20	17
5	48	36	27	21	45	34	26	20	31	24	18	28	22	17	25	20	16	13
6	44	31	23	17	41	30	22	16	27	20	15	24	18	14	22	17	13	11
7	40	28	20	14	38	26	19	14	24	17	13	22	16	12	19	14	11	9
8	37	25	17	12	35	24	17	11	22	15	11	19	14	10	18	13	9	7
9	34	22	15	10	32	21	15	10	20	13	9	18	12	8	16	11	8	6
10	32	20	14	9	30	20	13	9	18	12	8	16	11	7	15	10	7	5

Zone Lumens TOTAL LUMINAIRE EFFICIENCY = 64.2%

Zone	Lumens	TOTAL LUMINAIRE EFFICIENCY = 64.2%		
0-10	514.26	CIE Type – Direct		
10-20	1734.49	Plane	Spacing Criteria	
20-30	3370.99			
30-40	5333.06	0-180	2.32	
40-50	7165.13	90-270	2.32	
50-60	6195.93	Diagonal	2.04	
60-70	2879.28	ZONAL LUMEN SUMMARY		
70-80	921.95			
80-90	111.28	Zone	Lumens	% Lamp % Fixture
90-100	0.14	0-30	5619.74	12.8 19.9
100-110	0.00	0-40	10952.81	24.9 38.8
110-120	0.00	0-60	24313.86	55.3 86.1
120-130	0.00	0-90	28226.37	64.2 100.0
130-140	0.00	90-120	0.14	0.0 0.0
140-150	0.00	90-130	0.14	0.0 0.0
150-160	0.00	90-150	0.14	0.0 0.0
160-170	0.00	90-180	0.14	0.0 0.0
170-180	0.00	0-180	28226.50	64.2 100.0

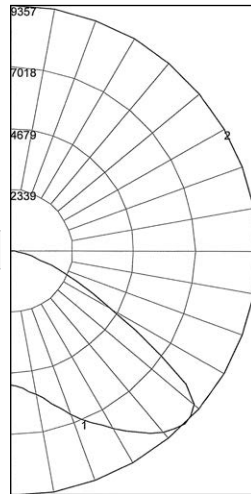

REPORT NUMBER: **KP40PHB**

Lamps: 400 W Pulse Start Metal Halide with
 Enclosed Reflector (**KPR-4HB**) *

Coefficients of Utilization – Zonal Cavity Method

Effective Floor Cavity Reflectance 0.20

% Floors Rfc	% Ceiling Rcc	% Walls Rw	20															
			80			70			50			30			10			0
0	76	76	76	76	75	75	75	75	71	71	71	68	68	68	65	65	65	64
1	70	67	65	63	69	66	64	62	63	61	60	61	59	58	59	57	56	55
2	64	59	55	51	62	58	54	50	55	52	49	53	51	48	51	49	47	46
3	58	51	46	42	56	50	46	42	48	44	41	47	43	40	45	42	40	38
4	53	45	39	35	51	44	39	35	43	38	34	41	37	34	40	36	33	32
5	48	40	34	30	47	39	34	29	38	33	29	36	32	29	35	31	28	27
6	44	35	29	25	43	35	29	25	34	29	25	32	28	25	31	28	24	23
7	41	32	26	22	39	31	26	22	30	25	22	29	25	21	28	24	21	20
8	37	29	23	19	36	28	23	19	27	22	19	26	22	19	26	22	19	17
9	35	26	20	17	34	25	20	17	25	20	17	24	20	16	23	19	16	15
10	32	24	18	15	32	23	18	15	23	18	15	22	18	15	21	17	15	13

Mercmaster™ II HID Luminaires

High Pressure Sodium and Pulse Start Metal Halide. Mogul Base

UNILETS® for Use with Threaded Metal Conduit.

NEC:

- Class I, Division 2, Groups A, B, C, D ①
- Class II, Division 1 and 2, Groups E, F, G ②
- Class III
- Fixtures Outside Type (Salt Water)

Applications

- Enclosed and gasketed HID lighting fixtures for use in tunnels, walkways, bridges, storage facilities, processing plants, parking lots, foundries, manufacturing plants, power plants and other locations where moisture, dirt, dust or corrosive atmospheres are encountered.
- Fixtures suited for Class I, Division 2; Class II, Division 1 and 2; and Class III. Suitable for use in wet and outdoor saltwater locations.
- Wide range of wattages and voltages. Choice of ballasts for 100 W-200 W PSMH; and 50 W-150 W HPS lamps in 120, 208, 240, 277 and 480 voltages.
- Choice of light sources: high pressure sodium and pulse start metal halide.
- Choice of optical assemblies: (1) prismatic globe with or without guard through 200 W; or (2) Type V closed prismatic glass refractor through 200 W. (Types II, III and IV also available through 200 W. Also polycarbonate globes for 100 W max.)
- Choice of mounting hoods: pendant (rigid or flexible), 25° (angle) stanchion, ceiling and wall mounting.
- Porcelain reflector for standard applications and Fiberglass reinforced polyester reflector for installations where luminaire is subject to exceptionally severe corrosive atmospheres.

Features

- Superior corrosion-resistance: copperfree aluminum mounting hoods, ballasts and guards with epoxy powder coat, inside and out.
- Standard pendant mounting hood for rigid or flexible mounting. Balanced round design automatically hangs plumb when used with flexible hanger.
- Positive sealing. Hinge and bolt construction assures 360° compression at all points on gasket.
- One-piece ballast housing for each component provides even heat dissipation for cooler operation and longer ballast life.
- Heat barrier isolates capacitor from ballast. Standard non-PCB biodegradable capacitors installed in separate compartment.
- Mogul socket is furnished with 200 °C (392 °F) welded leads, pre-wired to the ballast.
- Porcelain socket assures trouble-free operation in high ambient installations.
- Guards protect globes from damage. Keyhole slots allow easy installation and are secured with stainless steel screws.
- Prismatic glass globes and glass refractors are standard (plastic refractors also available) and thread directly into fixture housing. Eliminate glare and provide uniform light distribution.
- Vented reflectors result in cooler, dirt-free operation, increased lumen output.
- Reflectors secured to mounting hood with screws (furnished).
- Choice of reflector styles: white porcelain enamel or Fiberglass reinforced polyester; standard dome or 30° angle.
- Optional photocell provides automatic "on-off" control.
- All Mercmaster mounting hoods have provision for easy field installation of fuses in fixtures (see fuse kit listings).



Standard Materials

- Mounting hoods, ballast bodies and guards: copperfree (4/10 of 1% max.) aluminum
- Reflectors: fiberglass reinforced polyester
- Globes: 50 W-100 W, threaded prismatic glass; 150 W, 175 W and 200W, threaded heat-resistant prismatic glass
- Refractors: 50 W to 150 W, heat-resistant prismatic glass and plastic; 175 W to 200 W, prismatic glass

Standard Finishes

- Mounting hoods, ballast bodies, guards: epoxy powder-coat finish. Two-coat baked finish, electrostatically applied for complete uniform surface protection
- Polyester reflectors: natural finish

Options

- Fuses for fixtures. For fuse kits see *Electrical Specifications and Fuse Kits* page.
- MH fixtures for Quartz Auxiliary lamps. Relay switch installed in fixture when specified. Add suffix **-MTE** to fixture catalog number for 120 V through 277 V, and suffix **-480E** to fixture catalog number for 480 V fixture.
- Hot Restrike option add suffix **-R**.
- Smart Starter available for HPS and PSMH. Add suffix **-S**.

NEC Certifications and Compliances

- UL Standard: UL 1598, UL 1598A, UL 844
- UL Listed: E10444

① For specific Class I suitability of each fixture listed, see *Thermal Suitability*.

② For 175 W and 200 W fixtures, use 12" refractor only for Groups E, F and G. Heat-resistant glass globe supplied with 175 W and 200 W fixtures.

Note: Fixtures equipped with optional photocell or quartz auxiliary lamp do not comply with UL requirements and are not suitable for use in classified locations.

Mercmaster™ II HID Luminaires

High Pressure Sodium and Pulse Start Metal Halide. Mogul Base

UNILETS® for Use with Threaded Metal Conduit.

NEC:

- Class I, Division 2, Groups A, B, C, D ①
- Class II, Division 1 and 2, Groups E, F, G ②
- Class III
- Fixtures Outside Type (Salt Water)

Illustrated Features



High Temperature Sockets
Mogul base high temperature socket for 50W through 400W HID lamps.

Aluminum Inner Reflector
Solid aluminum inner reflector improves photometric efficiency.



Epoxy Finish
Ballast housing, hoods and guards are copperfree aluminum with epoxy powder coat finish.

Electrical Protection
Ground wire provided to bond mounting hood to ballast housing. Fiber insulator protects ballast and capacitor.



Photocell
Installs through knock-out in mounting hood; provides continuous ON-OFF dusk-to-dawn control. Fixtures with optional photocell or quartz auxiliary lamp do not comply with UL requirements for use in classified locations.



Fuses Mount to Hood Bosses
Two screws secure fuse kit to mounting boss in any Mercmaster mounting hood.



Hood/Ballast Gasket
Silicone rubber gasket seals out moisture, dirt and dust.



Stainless Steel Latch Assembly
Captive, stainless steel latch assembly bolt and nut closes securely, resists attack of corrosive atmospheres. Swing-away design simplifies servicing.



"Safety" High Hinge
Extra-high hinge provides additional protection against accidental ballast housing disengagement during installation or maintenance.

JB Series Box and Flexible Hanger



Balanced Round Design
Pendant fixtures automatically hang plumb. Fixtures and hangers suitable for Class I, Division 2 applications.

① For specific Class I suitability of each fixture listed, see Thermal Suitability.

② For 175 W and 200 W fixtures, use 12" refractor only for Groups E, F and G. Heat-resistant glass globe supplied with 175 W and 200 W fixtures.

Mercmaster™ II HID Luminaires

High Pressure Sodium and Pulse Start Metal Halide. Mogul Base

UNILETS® for Use with Threaded Metal Conduit.

NEC:

- Class I, Division 2, Groups A, B, C, D ①
- Class II, Division 1 and 2, Groups E, F, G ②
- Class III
- Fixtures Outside Type (Salt Water)

Quartz Emergency Light for Pulse Start Metal Halide or High Pressure Sodium Fixtures ③



Mercmaster fixtures for metal halide and high pressure sodium lamps can be supplied with a socket to accept a 150 W 120 V quartz lamp. This D.C. bayonet base socket is in addition to the standard lamp socket. In the event of a momentary power interruption, the quartz lamp is automatically switched on. The single ended quartz lamp remains energized until the HID restrikes and reaches about 60% output.

The quartz emergency lamp socket is wired to a 120 V tap on the ballast and is therefore independent of the lighting fixture voltage. No special field wiring is necessary.

Description	Catalog Suffix
For fixture volts of 120, 208, 240 or 277	-MTE
For fixture volts of 480	-480E

Accessory Options

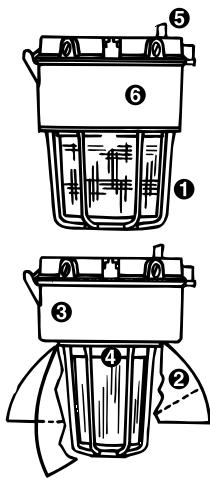

- ① **Guards:** Guards are die-cast copperfree aluminum with baked epoxy finish to match fixtures. Fixture supplied with stainless steel mounting screws which thread into stainless steel inserts on fixture housing to attach guard. To order fixture with guard, add suffix **-G** to catalog number before adding voltage suffix.
- ② **Reflectors:** Standard dome and 30° angle polyester reflectors.
- ③ **Hot Restrike:** Instantly restrikes a hot HPS lamp when power is restored after a momentary outage. Available factory-installed only. To order, add suffix **-R** to catalog number.
- ④ **Quartz Emergency Light:** When ordered, HPS fixtures will be supplied with a prewired special DC bayonet base socket to accept a 150W, 120V quartz lamp (not furnished) that automatically switches on when a power outage occurs. Fixtures ordered with this quartz emergency lamp feature do NOT comply with requirements for classified areas and should be used only in non-classified locations. To order, add suffix **-E** to catalog number and specify if a relay switch is desired.
- ⑤ **Photocell and Fuses:** Photocontrol.
- ⑥ **Smart Starter:** Performs as a conventional starter in lamp start-up. Removes itself from circuit at end of lamp life or if lamp is out of socket. Add suffix **-S** to catalog number.

① For specific Class I suitability of each fixture listed, see Thermal Suitability.
 ② For 175 W and 200 W fixtures, use 12" refractor only for Groups E, F and G. Heat-resistant glass globe supplied with 175 W and 200 W fixtures.
 ③ NOTE: Fixtures equipped with quartz emergency light do not comply with UL requirements and are not suitable for use in classified locations.

Mercmaster™ II HID Luminaires

Class I, Division 2, Groups A, B, C, D; Class II, Division 1, Groups E, F, G

UNILETS® for Use with Threaded Metal Conduit.

NEC:

- Class I, Division 2, Groups A, B, C, D ①
- Class II, Division 1 and 2, Groups E, F, G ②
- Class III
- Fixtures Outside Type (Salt Water)

The following table shows maximum operating temperatures of Mercmaster fixtures for Class I, Division 2, in a +40 °C (+104 °F) ambient in free air as rated by UL. As shown, the higher the Temperature Identification Number, the cooler the fixture operates. Keep this in mind when selecting a fixture for a specific chemical listed on the Classified Area Suitability pages. Per the NEC. The temperature marking shown on fixtures shall not exceed the

ignition temperature of the gas to be encountered. To illustrate, a 400W HPS fixture, which has a UL-NEC Temperature Identification Number of 350 [+326 — +350 °C (+619 — +662 °F)] does NOT exceed the Group D Methane (natural gas) ignition temperature of +540 °C (+1004 °F), and is therefore suitable for use in atmospheres containing that chemical.

Mercmaster II Thermal Suitability

Lamp		Supply Wire	Ambient Temp.	Class I, Division 2, Groups A, B, C, D				Class II, Division 1, Groups E, F, G			
Watts	Type	Temp. °C (°F)	°C (°F)	Globe	Globe and Reflector	8" Refractor	12" Refractor	Globe	Globe and Reflector	8" Refractor	12" Refractor
50	HPS	90 (194)	40 (104)	T3	T3	T3A	T3A	T3B	T3B	T3B	T3B
70	HPS	90 (194)	40 (104)	T3	T3	T3A	T3A	T3B	T3B	T3B	T3B
100	HPS	90 (194)	40 (104)	T2C	T2C	T3	T3	T3B	T3B	T3B	T3B
150	HPS	90 (194)	40 (104)	T2A	T2A	T2B	T2B	③	③	③	T3B
100	PSMH	90 (194)	40 (104)	T2A	T2A	T2C	T2C	③	③	③	T3
150	PSMH	90 (194)	40 (104)	T2B	T2B	T2D	T2D	T3	—	—	T3
175	PSMH	90 (194)	40 (104)	T2B	T2B	T2C	T2C	T3	—	—	T3
200	PSMH	90 (194)	40 (104)	T2	T2	T2B	T2B	T3	—	—	T3

“T” Numbers Represent the Maximum Lamp Temperature for Class I, Division 2 Locations and Maximum Surface Temperature Under Dust Blanket for Class II, Division 1 Locations.

“T” Number	T1	350	325	T2	T2A	T2B	T2C	T2D	T3	T3A	T3B	T3C	T4	T4A	T5	T6
Temp Range (°C)	351-450	326-350	301-325	281-300	261-280	231-260	216-230	201-215	181-200	166-180	161-165	136-160	121-135	101-120	86-100	85
Temp. Range (°F)	664-842	619-662	574-617	538-572	502-536	448-500	421-446	394-419	358-392	331-356	322-329	277-320	250-275	214-248	187-212	185

All HPS fixtures suitable for operation at -40 °C (-40 °F); PSMH at -29 °C (-20 °F).

① For specific Class I suitability of each fixture listed, see Thermal Suitability above.

② For 175 W and 200 W fixtures, use 12" refractor only for Groups E, F and G. Heat-resistant glass globe supplied with 175 W and 200 W fixtures.

③ Pendant, ceiling and wall mount are suitable for groups E and F only with T3A rating. Stanchion mount is suitable for groups E, F and G with a T3B rating.



Mercmaster™ II HID Luminaires

50 W, 70 W, 100 W, 150 W HPS

High Power Factor (Min. P.F. 90%). Suitable for Use in Wet Locations. Prismatic Glass Globe or Type V Closed Glass Refractor. Mogul Base Lamps.

NEC:

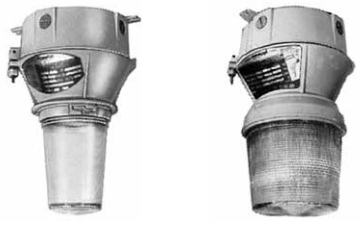
- Class I, Division 2, Groups A, B, C, D ①
- Class II, Division 1 and 2, Groups E, F, G ②
- Class III
- Fixtures Outside Type (Salt Water)

With Globe, Less Guard	With 8" Refractor (NEMA V)	Lamp Watts	Hub Size (Inches)	Catalog Numbers		
				With Globe ③	With 8" Refractor ④	With 12" Refractor
Pendant — One Hub, Rigid or Flexible Mounting						
	50	3/4		LPAL5075 ⑤	LPAL5075J ⑤	LPAL5075R ⑤
		1		LPAL5010 ⑤	LPAL5010J ⑤	LPAL5010R ⑤
	70	3/4		LPAL7075 ⑥	LPAL7075J ⑥	LPAL7075R ⑥
		1		LPAL7010 ⑥	LPAL7010J ⑥	LPAL7010R ⑥
	100	3/4		LPAL1075 ⑥	LPAL1075J ⑥	LPAL1075R ⑥
		1		LPAL1010 ⑥	LPAL1010J ⑥	LPAL1010R ⑥
	150	3/4		LPAL1575 ⑥	LPAL1575J ⑥	LPAL1575R ⑥
		1		LPAL1510 ⑥	LPAL1510J ⑥	LPAL1510R ⑥
Ceiling — Five Hubs, Four Close-Up Plugs						
	50	3/4		LPCL5075 ⑤	LPCL5075J ⑤	LPCL5075R ⑤
		1		LPCL5010 ⑤	LPCL5010J ⑤	LPCL5010R ⑤
	70	3/4		LPCL7075 ⑥	LPCL7075J ⑥	LPCL7075R ⑥
		1		LPCL7010 ⑥	LPCL7010J ⑥	LPCL7010R ⑥
	100	3/4		LPCL1075 ⑥	LPCL1075J ⑥	LPCL1075R ⑥
		1		LPCL1010 ⑥	LPCL1010J ⑥	LPCL1010R ⑥
	150	3/4		LPCL1575 ⑥	LPCL1575J ⑥	LPCL1575R ⑥
		1		LPCL1510 ⑥	LPCL1510J ⑥	LPCL1510R ⑥
Wall — Five Hubs, Four Close-Up Plugs						
	50	3/4		LPWBL5075 ⑤	LPWBL5075J ⑤	LPWBL5075R ⑤
		1		LPWBL5010 ⑤	LPWBL5010J ⑤	LPWBL5010R ⑤
	70	3/4		LPWBL7075 ⑥	LPWBL7075J ⑥	LPWBL7075R ⑥
		1		LPWBL7010 ⑥	LPWBL7010J ⑥	LPWBL7010R ⑥
	100	3/4		LPWBL1075 ⑥	LPWBL1075J ⑥	LPWBL1075R ⑥
		1		LPWBL1010 ⑥	LPWBL1010J ⑥	LPWBL1010R ⑥
	150	3/4		LPWBL1575 ⑥	LPWBL1575J ⑥	LPWBL1575R ⑥
		1		LPWBL1510 ⑥	LPWBL1510J ⑥	LPWBL1510R ⑥
25° Stanchion — One Hub						
	50	1-1/4		LPSL50125 ⑤	LPSL50125J ⑤	LPSL50125R ⑤
		1-1/2		LPSL50150 ⑤	LPSL50150J ⑤	LPSL50150R ⑤
	70	1-1/4		LPSL70125 ⑥	LPSL70125J ⑥	LPSL70125R ⑥
		1-1/2		LPSL70150 ⑥	LPSL70150J ⑥	LPSL70150R ⑥
	100	1-1/4		LPSL10125 ⑥	LPSL10125J ⑥	LPSL10125R ⑥
		1-1/2		LPSL10150 ⑥	LPSL10150J ⑥	LPSL10150R ⑥
	150	1-1/4		LPSL15125 ⑥	LPSL15125J ⑥	LPSL15125R ⑥
		1-1/2		LPSL15150 ⑥	LPSL15150J ⑥	LPSL15150R ⑥

① For specific Class I suitability of each fixture listed, see Thermal Suitability.

② For 175 W and 200 W fixtures, use 12" refractor only for Groups E, F and G. Heat-resistant glass globe supplied with 175 W and 200 W fixtures.

③ To order fixture with guard, add suffix -G (before adding voltage suffix).

④ Furnished with 8" NEMA V refractor — to order with NEMA I or III refractor, change J in the catalog number to J1 or J3.

Add voltage suffix -MTMED for Medium Base, 100W (order as special).

⑤ Add voltage suffix -MT for 120, 208, 240 or 277 V.

⑥ Add voltage suffix -MT for 120, 208, 240 or 277 V; -480 for 480 V.



Mercmaster™ II HID Luminaires

100 W, 150 W, 175 W, 200 W PSMH

Constant Wattage (Min. P.F. 90%). Suitable for Use in Wet Locations. Prismatic Glass Globe or Type V Closed Glass Refractor. Mogul Base Lamps.

NEC:

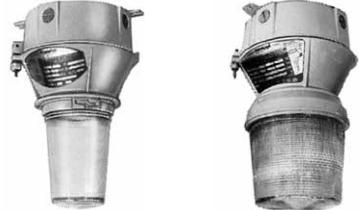
- Class I, Division 2, Groups A, B, C, D ①
- Class II, Division 1 and 2, Groups E, F, G ②
- Class III
- Fixtures Outside Type (Salt Water)

With Globe, Less Guard	With 8" Refractor (NEMA V)	Lamp Watts	Hub Size (Inches)	Catalog Numbers		
				With Globe ③	With 8" Refractor ④	With 12" Refractor
Pendant — One Hub, Rigid or Flexible Mounting						
	100	3/4	LPAH1075 ⑤	LPAH1075J ⑤	LPAH1075R ⑤	
		1	LPAH1010 ⑤	LPAH1010J ⑤	LPAH1010R ⑤	
	150	3/4	LPAP1575 ⑤	LPAP1575J ⑤	LPAP1575R ⑤	
		1	LPAP1510 ⑤	LPAP1510J ⑤	LPAP1510R ⑤	
	175 ②	3/4	LPAP1775 ⑤	LPAP1775J ⑤	LPAP1775R ⑤	
		1	LPAP1710 ⑤	LPAP1710J ⑤	LPAP1710R ⑤	
	200 ②	3/4	LPAP2075 ⑤	LPAP2075J ⑤	LPAP2075R ⑤	
		1	LPAP2010 ⑤	LPAP2010J ⑤	LPAP2010R ⑤	
Ceiling — Five Hubs, Four Close-Up Plugs						
	100	3/4	LPCH1075 ⑤	LPCH1075J ⑤	LPCH1075R ⑤	
		1	LPCH1010 ⑤	LPCH1010J ⑤	LPCH1010R ⑤	
	150	3/4	LPCP1575 ⑤	LPCP1575J ⑤	LPCP1575R ⑤	
		1	LPCP1510 ⑤	LPCP1510J ⑤	LPCP1510R ⑤	
	175 ②	3/4	LPCP1775 ⑤	LPCP1775J ⑤	LPCP1775R ⑤	
		1	LPCP1710 ⑤	LPCP1710J ⑤	LPCP1710R ⑤	
	200 ②	3/4	LPCP2075 ⑤	LPCP2075J ⑤	LPCP2075R ⑤	
		1	LPCP2010 ⑤	LPCP2010J ⑤	LPCP2010R ⑤	
Wall — Five Hubs, Four Close-Up Plugs						
	100	3/4	LPWBH1075 ⑤	LPWBH1075J ⑤	LPWBH1075R ⑤	
		1	LPWBH1010 ⑤	LPWBH1010J ⑤	LPWBH1010R ⑤	
	150	3/4	LPWBP1575 ⑤	LPWBP1575J ⑤	LPWBP1575R ⑤	
		1	LPWBP1510 ⑤	LPWBP1510J ⑤	LPWBP1510R ⑤	
	175 ②	3/4	LPWBP1775 ⑤	LPWBP1775J ⑤	LPWBP1775R ⑤	
		1	LPWBP1710 ⑤	LPWBP1710J ⑤	LPWBP1710R ⑤	
	200 ②	3/4	LPWBP2075 ⑤	LPWBP2075J ⑤	LPWBP2075R ⑤	
		1	LPWBP2010 ⑤	LPWBP2010J ⑤	LPWBP2010R ⑤	
25° Stanchion — One Hub						
	100	1-1/4	LPSH1075 ⑤	LPSH1075J ⑤	LPSH1075R ⑤	
		1-1/2	LPSH1010 ⑤	LPSH1010J ⑤	LPSH1010R ⑤	
	150	1-1/4	LPSP15125 ⑤	LPSP15125J ⑤	LPSP15125R ⑤	
		1-1/2	LPSP15150 ⑤	LPSP15150J ⑤	LPSP15150R ⑤	
	175 ②	1-1/4	LPSP17125 ⑤	LPSP17125J ⑤	LPSP17125R ⑤	
		1-1/2	LPSP17150 ⑤	LPSP17150J ⑤	LPSP17150R ⑤	
	200 ②	1-1/4	LPSP20125 ⑤	LPSP20125J ⑤	LPSP20125R ⑤	
		1-1/2	LPSP20150 ⑤	LPSP20150J ⑤	LPSP20150R ⑤	

① For specific Class I suitability of each fixture listed, see Thermal Suitability.

② For 175 W and 200 W fixtures, use 12" refractor only for Groups E, F and G. Heat-resistant glass globe supplied with 175 W and 200 W fixtures.

③ To order fixture with guard, add suffix -G (before adding voltage suffix).

④ Furnished with 8" NEMA V refractor — to order with NEMA I or III refractor, change J in the catalog number to J1 or J3.

Add voltage suffix -MTMED for Medium Base, 100W (order as special).

⑤ Add voltage suffix -MT for 120, 208, 240 or 277 V.

⑥ Add voltage suffix -MT for 120, 208, 240 or 277 V; -480 for 480 V.

Mercmaster™ II HID Luminaires

High Pressure Sodium and Pulse Start Metal Halide. Mogul Base

Hoods and Ballast Housings are Copperfree Aluminum (4/10 of 1%).





NEC:

Class I, Division 2, Groups A, B, C, D ①

Class II, Division 1 and 2, Groups E, F, G ②

Class III

Fixtures Outside Type (Salt Water)

Mounting Hoods		Description	Hub Size (Inches)	Catalog Number
Pendant				
		One Hub, Rigid or Flexible Mounting	3/4	LPA-75
			1	LPA-100
Ceiling				
		Five Hubs, Four Close-Up Plugs	3/4	LPC-75
			1	LPC-100
Wall				
		Five Hubs, Four Close-Up Plugs	3/4	LPWB-75
			1	LPWB-100
25° Stanchion				
		One Hub	1-1/4	LPS-125
			1-1/2	LPS-150
Mounting Adapter				
		Permits use of Mercmaster II pendant hood on existing V-51 and Mercmaster I mounting hoods. Remove Mercmaster I ballast body from existing mounting hood, thread in adapter and attach wire to Mercmaster II.		LPAD-1

Mercmaster II Ballast Bodies

Type	Lamp Watts	Ballast Body Catalog Numbers		Add Voltage Suffixes ①					
		Globe/12" Refractor	8" Refractor	120V	208V	240V	277V	480V	
High Pressure Sodium									
High Power Factor (Min. P.F. 90%)	50	LPB50L	LPBLH50R	-MT	-MT	-MT	-MT	-	
	70	LPB70L	LPBLH70R	-MT	-MT	-MT	-MT	-480	
	100	LPB100L	LPBLH100R	-MT	-MT	-MT	-MT	-480	
	150	LPB150L	LPBLH150R	-MT	-MT	-MT	-MT	-480	
Pulse Start Metal Halide									
Constant Wattage (Min. P.F. 90%)	100	LPB100H	LPBH100R	-MTMED	-MTMED	-MTMED	-MTMED	-480MED	
	150	LPB150P	LPBP150R	-MT	-MT	-MT	-MT	-480	
	175	LPB175P	LPBP175R	-MT	-MT	-MT	-MT	-480	
	200	LPB200P	LPBP200R	-MT	-MT	-MT	-MT	-480	



① For specific Class I suitability of each fixture listed, see Thermal Suitability.

② For 175 W and 200 W fixtures, use 12" refractor only for Groups E, F and G. Heat-resistant glass globe supplied with 175 W and 200 W fixtures.

③ **MT** (multi-volt) ballasts can be operated at an input voltage of either 120, 208, 240 or 277 V. **480** ballasts can be operated at input voltage of 480 V.

Mercmaster™ II HID Luminaires

High Pressure Sodium and Pulse Start Metal Halide. Mogul Base

Screws furnished to Fasten Reflectors to Ballast Body. Refractors Thread Directly into Ballast Body.

NEC:







- Class I, Division 2, Groups A, B, C, D ①
- Class II, Division 1 and 2, Groups E, F, G ②
- Class III
- Fixtures Outside Type (Salt Water)

		Description	Catalog Number
Prismatic Glass Globes			
		Clear Heat-Resistant	VPGL-2HR
		Amber	VPGL-2AM
		Blue	VPGL-2BL
		Green	VPGL-2GR
		Red	VPGL-2RE

Coated Prismatic Tuff-Skin® Glass Globes			
	For use in areas where fixture is subject to extreme thermal shock	Clear Heat-Resistant	VPGL-2HRT

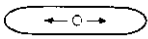
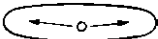
Polycarbonate Globes – Impact-Resistant ③			
	Use 100W Lamp max.; do not use in ambients exceeding +25 °C (+77 °F)	Clear Amber Green Red	VPGL-2PL VPGL-2AMPL VPGL-2GRPL VPGL-2REPL

Light Distribution	IES/NECA Distribution Curves	8" Glass (50–200 W ④)	12" Glass (50–200 W ④)	12" Polycarbonate (50–175 W ⑤)
--------------------	------------------------------	-----------------------	------------------------	--------------------------------

Closed Prismatic Refractors – 50 W-200 W ③						
 8" Refractor	 12" Refractor	NEMA I		LPG-R1	–	–
		NEMA II		–	LPRF-2CG	LPRF-2CP
		NEMA III		LPG-R3	–	LPRF-3CP
		NEMA IV		–	–	LPRF-4CP
		NEMA V		LPG-R5	LPRF-5CG	LPRF-5CP

① For specific Class I suitability of each fixture listed, see Thermal Suitability.

② For 175 W and 200 W fixtures, use 12" refractor only for Groups E, F and G. Heat-resistant glass globe supplied with 175 W and 200 W fixtures.

③ Polycarbonate globes are shatter-resistant – for use in processing plants, canneries, dairies, bakeries or anywhere broken glass would prove a hazard. Ideally suited for areas where vandalism, high replacement and high maintenance costs are a problem. Do not use in ambients exceeding +25 °C (+77 °F). For burning in vertical base-up positions only.

✦ Registered trademark of Thomas Manufacturing Corporation, Parkton, Md. It is recommended that guards be used with these globes.

④ 150 W max. for HPS.

⑤ 100 W max. for MH.







Mercmaster™ II HID Luminaires

High Pressure Sodium and Pulse Start Metal Halide. Mogul Base

Screws furnished to Fasten Reflectors to Ballast Body. Refractors Thread Directly into Ballast Body.

NEC:

- Class I, Division 2, Groups A, B, C, D ①
- Class II, Division 1 and 2, Groups E, F, G ②
- Class III
- Fixtures Outside Type (Salt Water)

Description		Catalog Number
Guard		
	Guard for Glass Globe	KGU2
Steel Guards for 8" and 12" Refractors		
	Guard for 8" Refractor	LPRG-2
	Guard for 12" Refractor 3 machine screws furnished	LPBG-12
Polyester Reflectors		
	Standard Dome	KR2-ST
	30° Angle	KR2-AN
Replacement Gaskets — Silicone Rubber		
	Globe and 12" Refractor Gasket	VPGL-GK
	8" Refractor Gasket	KRF-GK
Photocell (Hazardous)		
	120 Volt	PC120D2
	208 thru 277 Volt	PC247D2

Mounting Hood Weights

Type	Weight kg (lb)
Pendant	1.4 (3)
Ceiling	2.3 (5)

Type	Weight kg (lb)
Wall	2.3 (5)
Stanchion	1.8 (4)

Reflectors and Refractors — Weight includes globe and guard

Watts	HPS	PSMH	Standard Dome Reflector		30° Angle Reflector		8" Refractor		12" Refractor	
			Wt. kg (lb)	Catalog Number	Wt. kg (lb)	Catalog Number	Wt. kg (lb)	Catalog Number	Wt. kg (lb)	Catalog Number
50, 70	14	—								
100	15	15	1.1 (2.5)	KR2-ST	1.1 (2.5)	KR2-AN	2.4 (5.25)	LPG-R1	5.9 (13)	LPRF-5CG
150	16	—					2.4 (5.25)	LPG-R3	5.9 (13)	
175	—	16					2.4 (5.25)	LPG-R5	5.9 (13)	
200		18								

① For specific Class I suitability of each fixture listed, see Thermal Suitability.

② For 175 W and 200 W fixtures, use 12" refractor only for Groups E, F and G. Heat-resistant glass globe supplied with 175 W and 200 W fixtures.

Mercmaster™ II HID Luminaires

High Pressure Sodium and Pulse Start Metal Halide. Mogul Base

UNILETS® for Use with Threaded Metal Conduit.

NEC:

- Class I, Division 2, Groups A, B, C, D ①
- Class II, Division 1 and 2, Groups E, F, G ②
- Class III
- Fixtures Outside Type (Salt Water)

Electrical Specifications

Line Voltage	Type of Ballast	Starting Amps	Operating Amps	Total Watts
50 Watt High Pressure Sodium				
120	HX-HPF	0.58	0.58	64
208	HX-HPF	0.35	0.33	64
240	HX-HPF	0.31	0.29	64
277	HX-HPF	0.25	0.25	64
70 Watt High Pressure Sodium				
120	HX-HPF	0.90	0.82	94
208	HX-HPF	0.50	0.48	94
240	HX-HPF	0.44	0.41	94
277	HX-HPF	0.35	0.36	94
480	HX-HPF	0.21	0.21	94
100 Watt High Pressure Sodium				
120	HX-HPF	1.30	1.15	130
208	HX-HPF	0.76	0.67	130
240	HX-HPF	0.66	0.60	130
277	HX-HPF	0.60	0.52	130
480	HX-HPF	0.33	0.31	135
150 Watt High Pressure Sodium				
120	HX-HPF	2.00	1.70	188
208	HX-HPF	1.15	0.95	188
240	HX-HPF	1.00	0.85	188
277	HX-HPF	0.85	0.72	188
480	HX-HPF	0.50	0.47	189
100 Watt Pulse Start Metal Halide				
120	HX-HPF	1.20	1.15	130
208	HX-HPF	0.70	0.70	130
240	HX-HPF	0.61	0.58	130
277	HX-HPF	0.55	0.50	130
480	HX-HPF	0.30	0.35	140
150 Watt Pulse Start Metal Halide				
120	HX-HPF	1.75	1.60	188
208	HX-HPF	1.30	1.00	188
240	HX-HPF	0.85	0.80	188
277	HX-HPF	0.77	0.70	188
480	C.W.A.	0.45	0.42	185
175 Watt Pulse Start Metal Halide				
120	C.W.A.	0.90	1.78	199
208	C.W.A.	0.50	1.08	199
240	C.W.A.	0.35	0.89	199
277	C.W.A.	0.30	0.76	199
480	C.W.A.	0.25	0.50	213
200 Watt Pulse Start Metal Halide				
120	C.W.A.	2.10	2.00	238
208	C.W.A.	1.15	1.25	238
240	C.W.A.	1.10	1.00	238
277	C.W.A.	.75	.85	238
480	C.W.A.	.58	.50	237

Fuse Kit

Order fuses as a separate item by catalog number from right columns.

Lamp Watts	Volts	Fuse Quantity Required	Fuse Kit Catalog Number	
			HPS	PSMH
50	120	1	F5	—
	208	2	F3	—
	240	2	F3	—
	277	1	F2	—
70	120	1	F5	—
	208	2	F3	—
	240	2	F3	—
	277	1	F2	—
	480	2	F2	—
100	120	1	F8	F6
	208	2	F5	F4
	240	2	F5	F3
	277	1	F3	F3
150	480	2	F3	F2
	120	1	F10	F10
	208	2	F5	F5
	240	2	F5	F5
	277	1	F5	F4
175	480	2	F3	F3
	120	1	—	F5
	208	2	—	F3
	240	2	—	F3
200	277	1	—	F2
	480	2	—	F2
	120	1	—	F9
	208	2	—	F6
	240	2	—	F5
	277	1	—	F4
	480	2	—	F2



Fuses are filled with non-combustible granular material. Fuse Kit includes fuse, fuse block, wire, mounting screws and connectors. All mounting hoods have provisions for easy field installation of fuses in fixtures.

① For specific Class I suitability of each fixture listed, see Thermal Suitability.

② For 175 W and 200 W fixtures, use 12" refractor only for Groups E, F and G. Heat-resistant glass globe supplied with 175 W and 200 W fixtures.

Mercmaster™ II HID Luminaires

High Pressure Sodium and Pulse Start Metal Halide. Mogul Base

UNILETS® for Use with Threaded Metal Conduit.

NEC:

- Class I, Division 2, Groups A, B, C, D ①
- Class II, Division 1 and 2, Groups E, F, G ②
- Class III
- Fixtures Outside Type (Salt Water)

Dimensions in Millimeters (Inches)

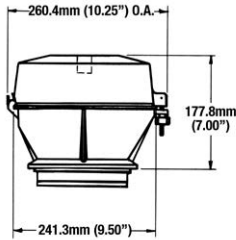

Pendant Mount

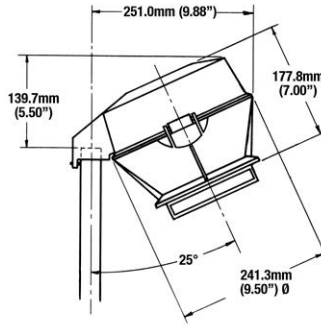

25° Angle Stanchion Mount

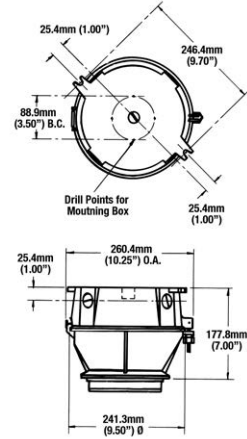

Ceiling Mount

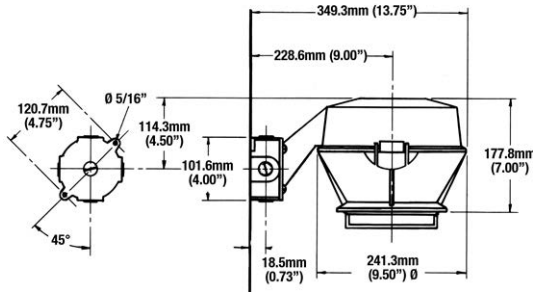

Wall Mount

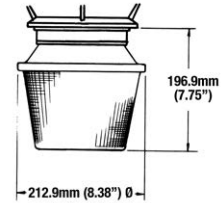

Fixture with 8" Refractor

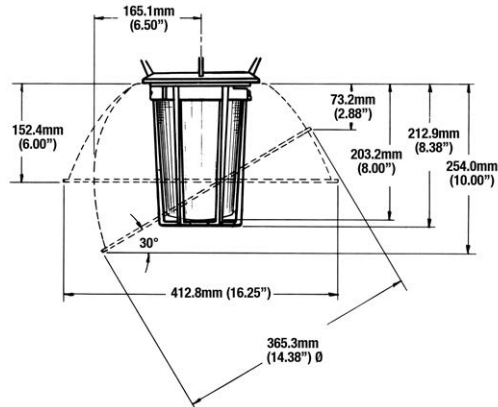

Fixture with Guard and Polyester Reflector

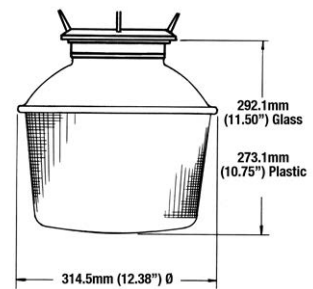

Fixture with 12" Refractor

① For specific Class I suitability of each fixture listed, see Thermal Suitability.

② For 175 W and 200 W fixtures, use 12" refractor only for Groups E, F and G. Heat-resistant glass globe supplied with 175 W and 200 W fixtures.

Mercmaster™ II HID Luminaires

150 W HPS

* Photometric data is based on fixtures with 150-watt clear High Pressure Sodium lamp (16,000 lumen). For candlepower values of fixtures with other HPS lamps, use the following multipliers; for 100 W (9,500 lumen) HPS lamp – 0.594; for 70 W (6,400 lumen) HPS lamp – 0.40; for 50 W (4,000 lumen) HPS lamp – 0.25. For candlepower values of fixture with guard, multiply by 0.95.

NEC:
 Class I, Division 2, Groups A, B, C, D ①
 Class II, Division 1 and 2, Groups E, F, G ②
 Class III
 Fixtures Outside Type (Salt Water)

Photometric Data

Total Luminaire Efficiency = 86.1%

CIE Type – Semi-Direct

Plane	Spacing Criteria
0-180	2.82
90-270	2.82
Diagonal	2.82

Zone	Lumens
0-10	50.74
10-20	164.55
20-30	310.47
30-40	611.05
40-50	961.13
50-60	1308.18
60-70	1542.35
70-80	1716.10
80-90	1799.18
90-100	1802.19
100-110	1676.86
110-120	1379.11
120-130	441.46
130-140	9.61
140-150	3.33
150-160	0.74
160-170	0.00
170-180	0.00

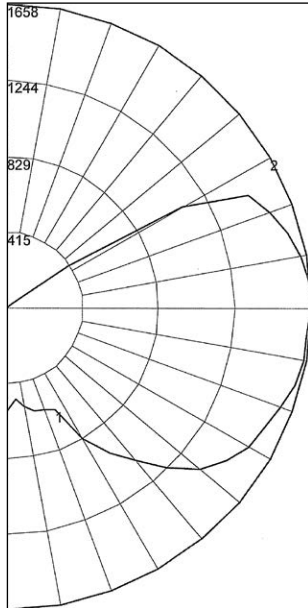

REPORT NUMBER: LP15LGG

150 W High Pressure Sodium fixture with Globe only *

Coefficients of Utilization – Zonal Cavity Method

Effective Floor Cavity Reflectance 0.20

% Ceiling Rcc	% Walls	Rw	80				70				50				30				10				0
			70	50	30	10	70	50	30	10	50	30	10	50	30	10	50	30	10	50	30	10	
0	95	95	95	95	89	89	89	89	77	77	77	67	67	67	57	57	57	53	0				
1	81	74	69	64	75	69	64	59	59	55	51	50	47	44	42	39	37	33	0				
2	71	62	54	47	65	57	50	44	49	43	38	41	36	32	33	30	27	23	0				
3	64	52	44	37	58	48	41	34	41	35	30	34	29	25	28	24	20	17	0				
4	57	45	36	30	53	42	34	28	35	29	24	29	24	20	24	19	16	13	0				
5	52	40	31	24	48	37	29	23	31	24	19	26	20	16	21	16	13	10	0				
6	48	35	26	20	44	32	25	19	27	21	16	23	17	13	18	14	11	8	0				
7	44	31	23	17	40	29	21	16	24	18	14	20	15	11	16	12	9	7	0				
8	40	28	20	15	37	26	19	14	22	16	12	18	13	10	15	11	8	6	0				
9	38	25	18	13	35	24	17	12	20	14	10	17	12	8	14	10	7	5	0				
10	35	23	16	11	32	22	15	11	18	13	9	15	11	7	13	9	6	4	0				

Zonal Lumen Summary

Zone	Lumens	% Lamp	% Fixture	Zone	Lumens	% Lamp	% Fixture
0-30	525.75	3.3	3.8	90-120	4858.16	30.4	35.3
0-40	1136.81	7.1	8.3	90-130	5299.62	33.1	38.5
0-60	3406.12	21.3	24.7	90-150	5312.56	33.2	38.5
0-90	8463.75	52.9	61.4	90-180	5313.30	33.2	38.6
				0-180	13777.05	86.1	100.0

Total Luminaire Efficiency = 73.6%

CIE Type – Direct

Plane	Spacing Criteria
0-180	1.46
90-270	1.46
Diagonal	1.68

Zone	Lumens
0-10	266.98
10-20	799.41
20-30	1337.05
30-40	1732.06
40-50	2067.60
50-60	2317.60
60-70	2210.81
70-80	866.77
80-90	145.09
90-100	14.46
100-110	8.75
110-120	7.93
120-130	4.51
130-140	2.16
140-150	0.48
150-160	0.00
160-170	0.00
170-180	0.00

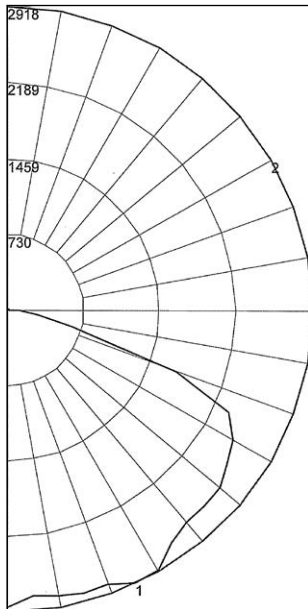

REPORT NUMBER: LP15LST

150 W High Pressure Sodium fixture with Standard Dome Reflector *

Coefficients of Utilization – Zonal Cavity Method

Effective Floor Cavity Reflectance 0.20

% Ceiling Rcc	% Walls	Rw	80				70				50				30				10				0
			70	50	30	10	70	50	30	10	50	30	10	50	30	10	50	30	10	50	30	10	
0	88	88	88	88	86	86	86	86	82	82	82	78	78	78	75	75	75	73	0				
1	79	76	72	69	77	74	71	68	71	68	66	68	66	64	65	64	62	60	0				
2	71	65	59	55	69	63	58	54	61	57	53	58	55	52	56	53	50	49	0				
3	64	56	49	44	62	55	49	44	52	47	43	50	46	42	48	45	41	40	0				
4	58	49	42	36	57	48	41	36	46	40	36	44	39	35	42	38	35	33	0				
5	53	43	36	31	52	42	35	30	40	35	30	39	34	30	38	33	29	28	0				
6	49	38	31	26	47	38	31	26	36	30	26	35	30	25	34	29	25	24	0				
7	45	34	27	23	44	34	27	23	33	27	22	31	26	22	30	26	22	20	0				
8	42	31	24	20	40	31	24	20	30	24	20	29	23	19	28	23	19	18	0				
9	39	28	22	18	38	28	22	18	27	21	17	26	21	17	25	21	17	16	0				
10	36	26	20	16	35	26	20	16	25	19	16	24	19	16	23	19	15	14	0				

Zonal Lumen Summary

Zone	Lumens	% Lamp	% Fixture	Zone	Lumens	% Lamp	% Fixture
0-30	2403.44	15.0	20.4	90-120	31.14	0.2	0.3
0-40	4135.50	25.8	35.1	90-130	35.65	0.2	0.3
0-60	8520.70	53.3	72.3	90-150	38.29	0.2	0.3
0-90	11743.37	73.4	99.7	90-180	38.29	0.3	0.3
				0-180	11781.65	73.6	100.0

① For specific Class I suitability of each fixture listed, see Thermal Suitability.

② For 175 W and 200 W fixtures, use 12" refractor only for Groups E, F and G. Heat-resistant glass globe supplied with 175 W and 200 W fixtures.

Mercmaster™ II HID Luminaires

150 W HPS

* Photometric data is based on fixtures with 150-watt clear High Pressure Sodium lamp (16,000 lumen). For candlepower values of fixtures with other HPS lamps, use the following multipliers; for 100 W (9,500 lumen) HPS lamp – 0.594; for 70 W (6,400 lumen) HPS lamp – 0.40; for 50 W (4,000 lumen) HPS lamp – 0.25. For candlepower values of fixture with guard, multiply by 0.95.

NEC:

- Class I, Division 2, Groups A, B, C, D ①
- Class II, Division 1 and 2, Groups E, F, G ②
- Class III
- Fixtures Outside Type (Salt Water)

Photometric Data

Total Luminaire Efficiency = 73.1%

CIE Type – Direct

Plane	Spacing Criteria
0-180	2.06
90-270	1.58
Diagonal	1.62

Zone	Lumens
0-10	222.62
10-20	664.60
20-30	1084.32
30-40	1536.55
40-50	1771.90
50-60	1771.51
60-70	1668.93
70-80	1422.36
80-90	994.54
90-100	432.23
100-110	104.58
110-120	20.99
120-130	1.21
130-140	0.04
140-150	0.00
150-160	0.00
160-170	0.00
170-180	0.00

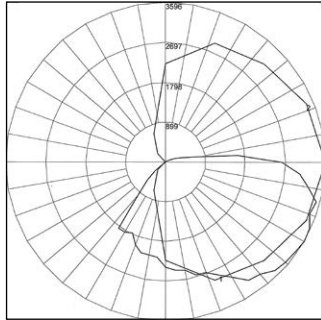

REPORT NUMBER: LP15LAN

150 W High Pressure Sodium fixture with 30° Angle Dome Reflector *

Coefficients of Utilization – Zonal Cavity Method

Effective Floor Cavity Reflectance 0.20

% Ceiling Rcc	% Walls	Rw	80				70				50				30				10				0
			70	50	30	10	70	50	30	10	50	30	10	50	30	10	50	30	10	50	30	10	
0	86	86	86	86	84	84	84	84	79	79	79	75	75	75	71	71	71	70	0				
1	76	71	67	63	73	69	65	62	65	62	59	62	59	57	58	56	54	52					
2	68	60	54	49	65	58	53	48	55	50	46	52	48	45	49	46	43	41					
3	61	52	45	39	59	50	44	39	48	42	37	45	40	36	43	39	35	33					
4	55	45	38	32	53	44	37	32	42	36	31	39	34	30	37	33	29	27					
5	50	40	33	27	49	39	32	27	37	31	26	35	30	25	33	29	25	23					
6	46	36	28	23	45	35	28	23	33	27	22	31	26	22	30	25	21	20					
7	43	32	25	20	41	31	25	20	30	24	19	28	23	19	27	22	19	17					
8	40	29	22	18	38	28	22	17	27	21	17	26	21	17	25	20	16	15					
9	37	26	20	16	36	26	20	16	25	19	15	24	19	15	23	18	15	13					
10	35	24	18	14	33	24	18	14	23	17	14	22	17	13	21	16	13	12					

Zonal Lumen Summary

Zone	Lumens	% Lamp	% Fixture	Zone	Lumens	% Lamp	% Fixture
0-30	1971.54	12.3	16.9	90-120	557.80	3.5	4.8
0-40	3508.09	21.9	30.0	90-130	559.01	3.5	4.8
0-60	7051.50	44.1	60.3	90-150	559.04	3.5	4.8
0-90	11137.33	69.6	95.2	90-180	559.04	3.5	4.8
0-180	11696.38	73.1	100.0				

Total Luminaire Efficiency = 81.1%

CIE Type – Semi-Direct

Plane	Spacing Criteria
0-180	1.98
90-270	1.98
Diagonal	3.40

Zone	Lumens
0-10	72.83
10-20	222.26
20-30	380.73
30-40	621.11
40-50	852.53
50-60	1765.29
60-70	3192.58
70-80	2366.61
80-90	1230.65
90-100	450.14
100-110	712.41
110-120	499.15
120-130	323.44
130-140	185.00
140-150	81.31
150-160	21.08
160-170	2.81
170-180	0.00

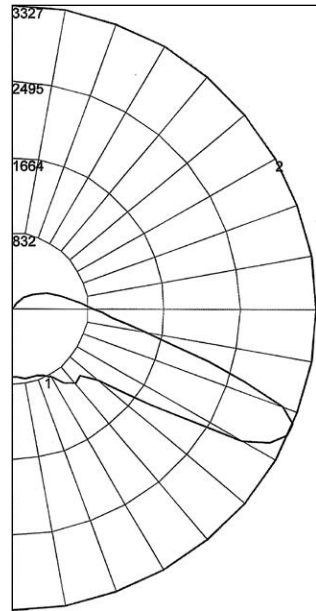

REPORT NUMBER: LP15LJ

150 W High Pressure Sodium fixture with 8" Prismatic Glass Refractor – NEMA Type V *

Coefficients of Utilization – Zonal Cavity Method

Effective Floor Cavity Reflectance 0.20

% Ceiling Rcc	% Walls	Rw	80				70				50				30				10				0
			70	50	30	10	70	50	30	10	50	30	10	50	30	10	50	30	10	50	30	10	
0	93	93	93	93	89	89	89	89	82	82	82	76	76	76	70	70	70	67					
1	80	73	68	63	76	70	65	61	64	60	56	58	55	52	53	50	48	45					
2	69	59	51	45	65	56	49	43	51	45	40	46	41	37	41	37	34	31					
3	61	49	40	33	57	47	38	32	42	35	29	38	32	27	34	29	25	22					
4	54	42	32	25	51	40	31	24	35	28	22	32	26	21	28	23	19	16					
5	49	36	27	20	46	34	26	19	31	23	18	27	21	16	24	19	15	12					
6	45	32	23	16	42	30	22	16	27	20	14	24	18	13	21	16	12	10					
7	41	28	20	14	38	27	19	13	24	17	12	24	15	11	19	14	10	8					
8	38	25	17	12	36	24	16	11	22	15	10	19	14	9	17	12	8	6					
9	35	23	15	10	33	22	15	10	20	13	9	18	12	8	16	11	7	5					
10	33	21	14	9	31	20	13	9	18	12	8	16	11	7	15	10	6	5					

Zonal Lumen Summary

Zone	Lumens	% Lamp	% Fixture	Zone	Lumens	% Lamp	% Fixture
0-30	675.83	4.2	5.2	90-120	1661.70	10.4	12.8
0-40	1296.93	8.1	10.0	90-130	1985.14	12.4	15.3
0-60	3914.76	24.5	30.2	90-150	2251.45	14.1	15.3
0-90	10704.60	66.9	82.5	90-180	2275.34	14.2	17.5
0-180	12979.94	81.1	100.0				

① For specific Class I suitability of each fixture listed, see Thermal Suitability.

② For 175 W and 200 W fixtures, use 12" refractor only for Groups E, F and G. Heat-resistant glass globe supplied with 175 W and 200 W fixtures.

Mercmaster™ II HID Luminaires

175 W PSMH

* Photometric data is based on fixtures with 175-watt clear Pulse Start Metal Halide lamp (17,500 lumen). For candlepower values of fixtures with other PSMH lamps, use the following multipliers: for 250 W (23,750 lumen) PSMH lamp – 1.36; for 100 W (8,500 lumen) PSMH lamp – 0.49. For candlepower values of fixture with guard, multiply by 0.95.

NEC:

- Class I, Division 2, Groups A, B, C, D ①
- Class II, Division 1 and 2, Groups E, F, G ②
- Class III
- Fixtures Outside Type (Salt Water)

Photometric Data

Total Luminaire Efficiency = 75.4%

CIE Type – General Diffuse

Plane	Spacing Criteria
0-180	n/a
90-270	n/a
Diagonal	n/a

Zone	Lumens
0-10	42.67
10-20	151.27
20-30	305.99
30-40	587.79
40-50	880.58
50-60	1114.51
60-70	1306.71
70-80	1568.03
80-90	1720.24
90-100	1797.50
100-110	1750.20
110-120	1559.14
120-130	391.09
130-140	7.81
140-150	3.19
150-160	0.61
160-170	0.18
170-180	0.00

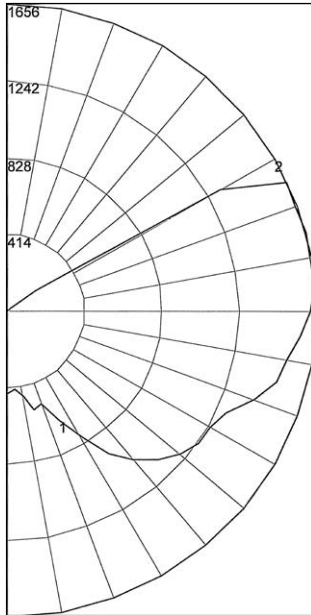

REPORT NUMBER: LP17PGG

175 W Pulse Start Metal Halide fixture with Globe only *

Coefficients of Utilization – Zonal Cavity Method

Effective Floor Cavity Reflectance 0.20

% Ceiling Rcc	80	70				50			30			10			0			
		70	50	30	10	70	50	30	10	50	30	10	50	30		10		
0	82	82	82	82	77	77	77	77	66	66	66	57	57	57	48	48	48	44
1	70	65	60	55	65	60	56	52	51	47	44	42	40	37	35	33	31	27
2	62	54	47	42	57	50	44	39	42	37	33	35	31	28	28	25	22	19
3	55	46	38	33	51	42	36	30	35	30	26	29	25	21	23	20	17	14
4	50	40	32	26	46	37	30	24	31	25	21	25	21	17	20	16	13	11
5	46	35	27	22	42	32	25	20	27	21	17	22	17	14	17	14	11	8
6	42	31	23	18	38	28	22	17	24	18	14	20	15	12	15	12	9	7
7	38	27	20	15	35	25	19	14	21	16	12	18	13	10	14	10	8	6
8	35	25	18	13	32	23	17	12	19	14	10	16	12	9	13	9	7	5
9	33	22	16	12	30	21	15	11	17	13	9	14	10	7	12	8	6	4
10	31	20	14	10	28	19	13	9	16	11	8	13	9	7	11	7	5	3

Zonal Lumen Summary

Zone	Lumens	% Lamp	% Fixture	Zone	Lumens	% Lamp	% Fixture
0-30	499.93	2.9	3.8	90-120	5106.84	29.2	38.7
0-40	1087.72	6.2	8.2	90-130	5497.93	31.4	41.7
0-60	3082.80	17.6	23.4	90-150	5508.93	31.5	41.7
0-90	7677.78	43.9	58.2	90-180	5509.71	31.5	41.8
				0-180	13187.48	75.4	100.0

Total Luminaire Efficiency = 63.8%

CIE Type – Direct

Plane	Spacing Criteria
0-180	1.50
90-270	1.50
Diagonal	1.66

Zone	Lumens
0-10	271.72
10-20	817.50
20-30	1392.53
30-40	1749.97
40-50	2044.83
50-60	2121.25
60-70	1862.42
70-80	720.46
80-90	141.89
90-100	14.66
100-110	8.28
110-120	9.57
120-130	5.69
130-140	3.14
140-150	2.17
150-160	1.71
160-170	1.70
170-180	0.36

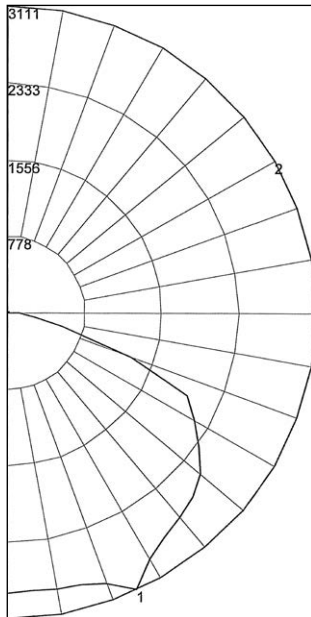

REPORT NUMBER: LP17PST

175 W Pulse Start Metal Halide fixture with Standard Dome Reflector *

Coefficients of Utilization – Zonal Cavity Method

Effective Floor Cavity Reflectance 0.20

% Ceiling Rcc	80	70				50			30			10			0			
		70	50	30	10	70	50	30	10	50	30	10	50	30		10		
0	76	76	76	76	74	74	74	74	71	71	71	68	68	68	65	65	65	64
1	69	66	63	61	67	65	62	60	62	60	58	59	57	56	57	55	54	53
2	62	57	52	48	61	56	51	48	53	50	47	51	48	46	49	47	45	43
3	56	49	44	39	55	48	43	39	46	42	38	45	41	38	43	40	37	35
4	51	43	37	33	50	42	37	33	41	36	32	39	35	32	38	34	31	30
5	47	38	32	28	45	37	32	28	36	31	27	35	30	27	33	30	27	25
6	43	34	28	24	42	33	28	24	32	27	23	31	27	23	30	26	23	22
7	40	31	25	21	39	30	25	21	29	24	20	28	24	20	27	23	20	19
8	37	28	22	18	36	27	22	18	26	22	18	26	21	18	25	21	18	16
9	34	25	20	16	33	25	20	16	24	19	16	23	19	16	23	19	16	15
10	32	23	18	15	31	23	18	15	22	18	14	22	17	14	21	17	14	13

Zonal Lumen Summary

Zone	Lumens	% Lamp	% Fixture	Zone	Lumens	% Lamp	% Fixture
0-30	2481.75	14.2	22.2	90-120	32.51	0.2	0.3
0-40	4231.72	24.2	37.9	90-130	38.20	0.2	0.3
0-60	8397.80	48.0	75.2	90-150	43.51	0.2	0.3
0-90	11122.57	63.6	99.6	90-180	47.28	0.3	0.4
				0-180	11169.85	63.8	100.0

① For specific Class I suitability of each fixture listed, see Thermal Suitability.

② For 175 W and 200 W fixtures, use 12" refractor only for Groups E, F and G. Heat-resistant glass globe supplied with 175 W and 200 W fixtures.

Mercmaster™ II HID Luminaires

175 W PSMH

* Photometric data is based on fixtures with 175-watt clear Pulse Start Metal Halide lamp (17,500 lumen). For candlepower values of fixtures with other PSMH lamps, use the following multipliers: for 250 W (23,750 lumen) PSMH lamp – 1.36; for 100 W (8,500 lumen) PSMH lamp – 0.49. For candlepower values of fixture with guard, multiply by 0.95.

NEC:

- Class I, Division 2, Groups A, B, C, D ①
- Class II, Division 1 and 2, Groups E, F, G ②
- Class III
- Fixtures Outside Type (Salt Water)

Photometric Data

Total Luminaire Efficiency = 61.6%

CIE Type – Direct

Plane	Spacing Criteria
0-180	2.02
90-270	1.62
Diagonal	1.58

Zone	Lumens
0-10	221.01
10-20	674.48
20-30	1111.79
30-40	1519.14
40-50	1697.13
50-60	1644.77
60-70	1457.83
70-80	1248.84
80-90	814.94
90-100	280.33
100-110	87.54
110-120	16.66
120-130	1.25
130-140	0.06
140-150	0.06
150-160	0.00
160-170	0.00
170-180	0.00

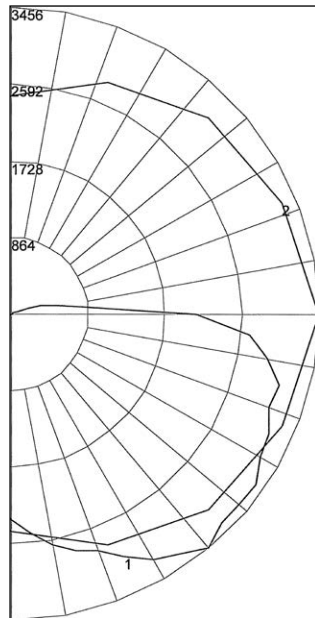

REPORT NUMBER: **LP17PAN**

175 W Pulse Start Metal Halide fixture with 30° Angle Dome Reflector *

Coefficients of Utilization – Zonal Cavity Method

Effective Floor Cavity Reflectance 0.20

% Ceiling Rcc	% Walls Rw	80				70				50				30				10				0
		70	50	30	10	70	50	30	10	50	30	10	50	30	10	50	30	10	50	30	10	
0	0	73	73	73	73	71	71	71	71	67	67	67	64	64	64	61	61	61	59	0		
1	1	64	61	57	54	62	59	56	53	56	53	51	53	51	49	50	49	47	45	0		
2	2	58	52	46	42	56	50	45	42	47	44	40	45	42	39	43	40	38	36	0		
3	3	52	45	39	34	50	43	38	34	41	36	33	39	35	32	37	34	31	29	0		
4	4	47	39	33	28	46	38	32	28	36	31	27	34	30	27	33	29	26	24	0		
5	5	43	34	28	24	42	34	28	24	32	27	23	30	26	23	29	25	22	21	0		
6	6	40	31	25	20	38	30	24	20	29	24	20	27	23	20	26	22	19	18	0		
7	7	37	28	22	18	35	27	22	18	26	21	17	25	20	17	24	20	17	15	0		
8	8	34	25	20	16	33	25	19	16	24	19	15	23	18	15	22	18	15	14	0		
9	9	32	23	18	14	31	23	17	14	22	17	14	21	17	13	20	16	13	12	0		
10	10	30	21	16	13	29	21	16	12	20	15	12	19	15	12	18	15	12	11	0		

Zonal Lumen Summary

Zone	Lumens	% Lamp	% Fixture	Zone	Lumens	% Lamp	% Fixture
0-30	2007.28	11.5	18.6	90-120	384.53	2.2	3.6
0-40	3526.41	20.2	32.7	90-130	385.77	2.2	3.6
0-60	6868.32	39.2	63.7	90-150	385.89	2.2	3.6
0-90	10389.94	59.4	96.4	90-180	385.89	2.2	3.6
0-180	10775.83	61.6	100.0				

Total Luminaire Efficiency = 73.9%

CIE Type – Semi-Direct

Plane	Spacing Criteria
0-180	2.08
90-270	2.08
Diagonal	3.78

Zone	Lumens
0-10	58.60
10-20	179.87
20-30	316.74
30-40	543.99
40-50	726.99
50-60	1445.41
60-70	3661.34
70-80	2432.42
80-90	1351.63
90-100	477.79
100-110	717.26
110-120	474.07
120-130	293.44
130-140	163.08
140-150	70.40
150-160	18.48
160-170	2.58
170-180	0.00

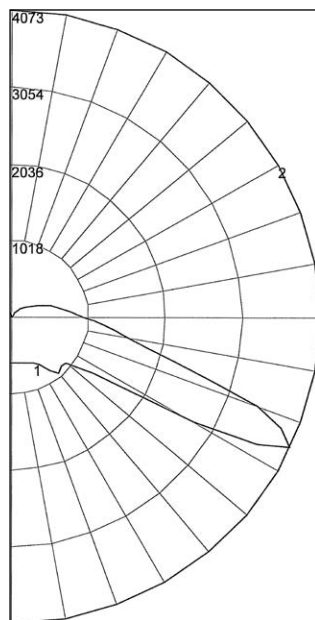

REPORT NUMBER: **LP17PJ**

175 W Pulse Start Metal Halide fixture with Globe and 8" Prismatic Glass Refractor – NEMA Type V *

Coefficients of Utilization – Zonal Cavity Method

Effective Floor Cavity Reflectance 0.20

% Ceiling Rcc	% Walls Rw	80				70				50				30				10				0
		70	50	30	10	70	50	30	10	50	30	10	50	30	10	50	30	10	50	30	10	
0	0	85	85	85	85	82	82	82	82	75	75	75	69	69	69	64	64	64	61	0		
1	1	72	66	61	56	68	63	58	54	57	54	50	52	49	46	47	45	43	40	0		
2	2	62	53	46	39	59	51	44	38	46	40	35	41	36	32	37	33	30	27	0		
3	3	55	44	35	29	51	41	34	28	37	31	25	33	28	23	30	25	21	19	0		
4	4	49	37	28	22	46	35	27	21	31	24	19	28	22	17	25	20	16	13	0		
5	5	44	32	23	17	41	30	22	16	27	20	15	24	18	14	21	16	12	10	0		
6	6	40	28	20	14	37	26	19	13	24	17	12	21	15	11	19	14	10	8	0		
7	7	37	25	17	12	34	23	16	11	21	15	10	19	13	9	17	12	8	6	0		
8	8	34	22	15	10	32	21	14	9	19	13	8	17	12	8	15	10	7	5	0		
9	9	31	20	13	8	30	19	13	8	17	11	7	16	10	7	14	9	6	4	0		
10	10	29	18	12	7	28	18	11	7	16	10	6	14	9	6	13	8	5	4	0		

Zonal Lumen Summary

Zone	Lumens	% Lamp	% Fixture	Zone	Lumens	% Lamp	% Fixture
0-30	555.22	3.2	4.3	90-120	1669.13	9.5	12.9
0-40	1099.21	6.3	8.5	90-130	1962.57	11.2	15.2
0-60	3271.60	18.7	25.3	90-150	2196.06	12.5	15.2
0-90	10717.00	61.2	82.9	90-180	2217.10	12.7	17.1
0-180	12934.11	73.9	100.0				

① For specific Class I suitability of each fixture listed, see Thermal Suitability.

② For 175 W and 200 W fixtures, use 12" refractor only for Groups E, F and G. Heat-resistant glass globe supplied with 175 W and 200 W fixtures.

Mercmaster™ II HID Luminaires

High Pressure Sodium and Pulse Start Metal Halide. Mogul Base

UNILETS® for Use with Threaded Metal Conduit.

NEC:

- Class I, Division 2, Groups A, B, C, D ①
- Class II, Division 1 and 2, Groups E, F, G ②
- Class III
- Fixtures Outside Type (Salt Water)

Isofootcandle Data

HPS Lamp Wattage	Mounting Height M (Ft)	Horizontal Distance from Mounting Point M (Ft)										
		0 (0)	1.5 (5)	3.0 (10)	4.6 (15)	6.1 (20)	7.6 (25)	9.1 (30)	10.7 (35)	12.2 (40)	13.7 (45)	50 (152)

Mercmaster II, High Pressure Sodium, No Reflector, No Guard

70 Watt – 5,800 Lumen
100 Watt – 9,500 Lumen
150 Watt – 16,000 Lumen

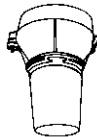

Footcandle Chart (Initial Horiz. FTC)

70	2.4 (8)	.60	2.70	1.50	.73	.38	.21	.13	.08	.06	.04	.03
	3.0 (10)	.39	1.70	1.30	.72	.40	.24	.15	.10	.07	.05	.04
	3.7 (12)	.27	1.10	1.10	.68	.41	.26	.17	.11	.08	.06	.04
	4.6 (15)	.17	.66	.81	.60	.39	.26	.18	.13	.09	.07	.05
	6.1 (20)	.10	.37	.43	.40	.33	.25	.18	.13	.10	.08	.06
100	2.4 (8)	1.00	4.80	2.70	1.20	.62	.35	.21	.14	.10	.07	.05
	3.0 (10)	.64	2.80	2.20	1.30	.67	.40	.25	.16	.11	.08	.06
	3.7 (12)	.44	1.80	1.80	1.30	.71	.42	.28	.18	.13	.09	.07
	4.6 (15)	.28	1.10	1.30	.97	.70	.45	.30	.21	.15	.11	.08
	6.1 (20)	.16	.59	.69	.70	.55	.42	.32	.23	.17	.13	.10
150	2.4 (8)	2.50	8.30	4.60	2.20	1.10	.62	.38	.25	.17	.12	.09
	3.0 (10)	1.60	5.40	4.00	2.20	1.20	.71	.44	.29	.20	.14	.11
	3.7 (12)	1.10	4.20	3.30	2.00	1.20	.76	.49	.33	.23	.17	.12
	4.6 (15)	.72	2.10	2.40	1.80	1.20	.79	.54	.38	.27	.20	.15
	6.1 (20)	.40	1.10	1.30	1.30	1.00	.73	.54	.40	.30	.23	.18

Mercmaster II, High Pressure Sodium, With Reflector, No Guard

70 Watt – 5,800 Lumen
100 Watt – 9,500 Lumen
150 Watt – 16,000 Lumen

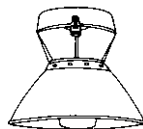

Footcandle Chart (Initial Horiz. FTC)

70	2.4 (8)	14.80	10.00	3.80	1.50	.55	.15	.05	.03	.02	.01	.01
	3.0 (10)	9.50	7.70	3.70	1.60	.74	.32	.12	.05	.03	.02	.01
	3.7 (12)	6.60	6.60	3.30	1.50	.87	.46	.18	.10	.05	.02	.02
	4.6 (15)	4.20	4.20	2.70	1.70	.94	.56	.33	.18	.10	.06	.03
	6.1 (20)	2.40	2.50	1.90	1.30	.92	.62	.41	.28	.18	.12	.08
100	2.4 (8)	21.90	16.80	6.30	2.40	.86	.28	.08	.05	.03	.02	.01
	3.0 (10)	14.00	12.40	6.00	2.70	1.20	.53	.19	.07	.04	.03	.02
	3.7 (12)	9.70	9.40	5.50	2.80	1.40	.73	.36	.20	.13	.04	.03
	4.6 (15)	6.20	6.70	4.40	2.70	1.60	.90	.53	.33	.19	.11	.05
	6.1 (20)	3.50	4.30	3.10	2.20	1.50	1.0	.68	.44	.30	.21	.13
150	2.4 (8)	36.90	27.80	10.50	3.80	1.30	.35	.14	.08	.04	.03	.02
	3.0 (10)	23.60	20.80	10.10	4.40	2.00	.78	.29	.11	.07	.04	.03
	3.7 (12)	16.40	15.80	9.20	4.60	2.20	1.20	.54	.30	.16	.06	.04
	4.6 (15)	10.50	11.60	7.50	4.50	2.60	1.50	.86	.42	.26	.16	.08
	6.1 (20)	5.90	7.20	5.20	3.70	2.50	1.70	1.10	.73	.50	.32	.19

① For specific Class I suitability of each fixture listed, see Thermal Suitability.

② For 175 W and 200 W fixtures, use 12" refractor only for Groups E, F and G. Heat-resistant glass globe supplied with 175 W and 200 W fixtures.

Mercmaster™ Jr. Luminaires

High Pressure Sodium. Suitable for Use in Wet Locations

UNILETS® for Use with Threaded Metal Conduit. 120 V Integral Ballast. Medium Base Socket for Medium Base Lamps.

NEC:

With Globe:

35 W, 50 W:

Class I, Division 2, Groups A, B, C, D

Class II, Division 1 and 2, Groups E ②, F, G

Class III

NEC:

70 W: ①

Class I, Division 2, Groups A, B, C, D

Class II, Division 1 and 2, Groups E ②, F

100 W, 150 W: ①

Class I, Division 2, Groups A, B, C, D

NEC:

With Refractor (NEMA V):

35 W, 50 W, 70 W, 100 W:

Class I, Division 2, Groups A, B, C, D

Class II, Division 1 and 2, Groups E ②, F, G

Class III

NEC:

150 W: ①

Class I, Division 2, Groups A, B, C, D

Applications

- Inexpensive HID integrally ballasted fixture for use in hazardous locations – inexpensive to buy and inexpensive to operate (uses one-fifth as much electrical energy as incandescent and three-quarters as much as fluorescent).
- Enclosed and gasketed HID lighting fixtures for use in tunnels, walkways, bridges, storage facilities, processing plants, parking lots, foundries, manufacturing plants, power plants and other locations where moisture, dirt, dust or corrosive atmospheres are encountered.

Features

- “Wireless” design. Threading of fixture unit onto mounting hood makes electrical connection. Only wiring required is attaching two wires to connection block in mounting hood.
- Safe, easy servicing without disconnecting any wiring. “Wireless” fixture unit easily threads off mounting hood for convenient servicing.
- Quick, easy conversion from Appleton V-51® incandescent installation to Mercmaster Jr. HID. Just remove V-51® fixture unit and thread Mercmaster Jr. fixture unit onto existing V-51® mounting hood.
- Choice of mounting hoods. Standard fixtures in pendant, ceiling, outlet box, wall and stanchion mountings.
- Standard pendant mounting hood for rigid or flexible mounting. Balanced round design automatically hangs plumb when used with flexible hanger.
- Unitized construction reduces installation and maintenance costs.
- Ballast has standard non-PCB biodegradable capacitors.
- Medium base socket is furnished with 200 °C (392 °F) leads, prewired to the ballast. Porcelain socket assures trouble-free operation in high ambient installations.
- Prismatic glass globe or glass refractor is standard and threads directly into fixture housing. Eliminates glare and provides uniform light distribution.
- Fiberglass reinforced polyester reflector for exceptionally severe corrosive atmospheres. Vented for cooler, dirt-free operation, increased lumen output.

Standard Materials

- Mounting hoods: copperfree (4/10 of 1% max.) aluminum or malleable iron
- Ballast bodies: copperfree (4/10 of 1% max.) aluminum
- Guards: copperfree (4/10 of 1% max.) aluminum or steel
- Reflectors: fiberglass reinforced polyester or porcelain
- Globe: 35 W-100 W, threaded prismatic glass and threaded polycarbonate; 150 W, threaded heat-resistant prismatic glass
- Refractor: heat-resistant prismatic glass

Standard Finishes

- Ballast bodies, aluminum guard and VMA, VXHA-A, OBVW1-A, OBV1-A, JBW1-A, JB1-A, GSW2 and MS mounting hoods: epoxy powder coat finish, electrostatically applied for complete, uniform surface protection
- VA, VXHA, OBVW1, OBV1, GS-2, JBW1, and JB1 malleable iron mounting hoods: triple coat – (1) zinc electroplate; (2) chromate; and (3) epoxy powder coat
- Steel guard: zinc electroplate



Illustrated Feature

Conversion from Appleton V-51 incandescent installation to HID Mercmaster Jr. is easy and fast.



Step No. 1:

After power is shut off, remove present incandescent V-51 fixture unit from existing V-51 mounting hood.



Step No. 2:

Thread Mercmaster Jr. HID fixture unit onto existing V-51 mounting hood – and conversion is completed.

Options

- Fuses for fixtures, factory installed. Add suffix -F.

NEC Certifications and Compliances

- UL Standard: UL 1598, UL 1598A, UL 844
- UL Listed: E10444

① The MJBW Wall Mount Fixture is suitable for Class I, Division 2, Groups A, B, C and D only.

② Per NEC 500.6(1), there is no such classification as Class II, Division 2, Group E.

Mercmaster™ Jr. Luminaires

High Pressure Sodium. Suitable for Use in Wet Locations

UNILETS® for Use with Threaded Metal Conduit. 120 V Integral Ballast. Medium Base Socket for Medium Base Lamps.

NEC:
With Globe:
 35 W, 50 W:
 Class I, Division 2, Groups A, B, C, D
 Class II, Division 1 and 2, Groups E ②, F, G
 Class III

NEC:
 70 W: ①
 Class I, Division 2, Groups A, B, C, D
 Class II, Division 1 and 2, Groups E ②, F
 100 W, 150 W: ①
 Class I, Division 2, Groups A, B, C, D

NEC:
With Refractor (NEMA V):
 35 W, 50 W, 70 W, 100 W:
 Class I, Division 2, Groups A, B, C, D
 Class II, Division 1 and 2, Groups E ②, F, G
 Class III

NEC:
 150 W: ①
 Class I, Division 2, Groups A, B, C, D

Thermal Suitability

Table at below shows maximum operating temperatures of Mercmaster Jr. fixtures for Class I, Division 2, in a 40 °C (104 °F) ambient. Per NEC 500.8(B)(4), the temperature marking on fixtures shall not exceed the ignition temperature of the specific gas or vapor to be encountered. NEC 500.8(B)(4) states that these markings (Identification Numbers) "marked on equipment nameplates shall be in accordance with Table NEC 500.8(C)." This NEC table is duplicated, as it applies to Appleton Mercmaster Jr. fixtures, in the table below.

As shown, the higher the Temperature Identification Number, the cooler the fixture operates. Keep this in mind when selecting a fixture for a specific gas or vapor.

Example:

- Gasoline (56-60 octane)
 - Fixture with Globe and Reflector
- To determine Mercmaster Jr. thermal suitability for the above example:
- Check the Thermal Suitability on the following page for ignition temperature of gas or vapor to be encountered. It reveals that 56-60 octane gasoline has an ignition temperature of 280 °C (536 °F).
 - Look in table below for fixtures under "With Globe and Reflector" that do not exceed the 280 °C (536 °F) ignition temperature of the gasoline.
 - Select the best fixture for your purpose. The 35 W, 50 W, 70 W or 100 W fixture with globe and reflector is acceptable because none of these fixture lamp surfaces exceed the 280 °C (536 °F) ignition temperature of the gasoline.

Temperature Identification Numbers

Lamp Watts	Class I, Division 2, Groups A, B, C and D				Class II, Division 1 and 2, Groups E, F and G		
	With Globe or with Globe and Reflector		With 8" Refractor		With Globe, with Globe and Reflector, or with 8" Refractor		
	Name-plate Marking	Temperature Range °C (°F)	Nameplate Marking	Temperature Range °C (°F)	Nameplate Marking	Temperature Range °C (°F)	Groups
35	T4	121-135 (250-275)	T4	121-135 (250-275)	T4C	101-120 (214-248)	E, F, G
50	T2D	201-215 (394-419)	T3	181-200 (358-392)	T3C	136-160 (277-320)	E, F, G
70	T2B	231-260 (448-500)	T2C	216-230 (421-446)	T3B	161-165 (322-329)	E, F, G ③
100	T2A	261-280 (502-536)	T2B	231-260 (448-500)	—	—	E, F, G ④
150	T2	281-300 (538-572)	T2A	261-280 (502-536)	—	—	—

Ambient Suitability of Mercmaster Jr. Fixtures

All fixtures suitable for operation at -40 °C (-40 °F).

35W	50W	70W	100W	150W
40 °C (104 °F)	40 °C (104 °F)	25 °C (77 °F)	25 °C (77 °F)	25 °C (77 °F)

Electrical Specifications (Reactor Ballasts)

Lamp Watts	Line Voltage 60 Hz	Line Current in Amperes		Input Watts
		Starting HPF	Operating HPF	
35	120	0.41	0.38	43
50	120	0.62	0.56	60
70	120	0.70	0.73	82
100	120	1.10	1.00	115
150	120	1.70	1.50	170

Retrofits Incandescent Fixtures Easily and Quickly

- 35 W HPS Comparable to 100/150 W Incandescent Lamp
- 50 W HPS Comparable to 200 W Incandescent Lamp
- 70 W HPS Comparable to 300 W Incandescent Lamp
- 100 W HPS Comparable to 1.5 300 W Incandescent Lamp ⑤
- 150 W HPS Comparable to 2.5 300 W Incandescent Lamp ⑤

Optional Factory-Installed Fuses – Add Suffix -F

Available as a factory installed item with Mercmaster Jr. fixtures.

① The MJBW Wall Mount Fixture is suitable for Class I, Division 2, Groups A, B, C and D only.
 ② Per NEC 500.6(1), there is no such classification as Class II, Division 2, Group E.
 ③ 70W suitable for Groups E and F with globe; suitable for Groups E, F, and G with refractor.
 ④ 100W suitable for Groups E, F and G with refractor only.
 ⑤ These are guidelines only. Light distribution and other factors must be taken into consideration.

Mercmaster™ Jr. Luminaires

35 W, 50 W, 70 W, 100 W, 150 W HPS

Complete with Mounting Hood. Medium Base Socket. High Power Factor (Min. P.F. 90%). Integral Ballast for 120 V Line Operation.

NEC:

With Globe:

35 W, 50 W:

Class I, Division 2, Groups A, B, C, D

Class II, Division 1 and 2, Groups E ②, F, G

Class III

NEC:

70 W: ①

Class I, Division 2, Groups A, B, C, D

Class II, Division 1 and 2, Groups E ②, F

100 W, 150 W: ①

Class I, Division 2, Groups A, B, C, D

NEC:

With Refractor (NEMA V):

35 W, 50 W, 70 W, 100 W:

Class I, Division 2, Groups A, B, C, D











Class II, Division 1 and 2, Groups E ②, F, G

Class III

NEC:

150 W: ①

Class I, Division 2, Groups A, B, C, D

With Globe, Less Guard	With Refractor (NEMA V)	Lamp Watts	ANSI Lamp Type	Hub Size (Inches)	With Globe, Less Guard	Catalog Number ⑥	With Refractor (NEMA V)
Pendant — Aluminum mounting hood and ballast body. One Hub, Rigid or Flexible Mounting							
		35	S76	3/4 1	MA3575-120 MA3510-120	MA3575J-120 MA3510J-120	
		50	S68	3/4 1	MA5075-120 MA5010-120	MA5075J-120 MA5010J-120	
		70	S62	3/4 1	MA7075-120 MA7010-120	MA7075J-120 MA7010J-120	
		100	S54	3/4 1	MA1075-120 MA1010-120	MA1075J-120 MA1010J-120	
		150	S55	3/4 1	MA1575-120 MA1510-120	MA1575J-120 MA1510J-120	
Ceiling — Aluminum mounting hood and ballast body. Five Hubs, Four Close-Up Plugs							
		35	S76	3/4 1	MC3575-120 MC3510-120	MC3575J-120 MC3510J-120	
		50	S68	3/4 1	MC5075-120 MC5010-120	MC5075J-120 MC5010J-120	
		70	S62	3/4 1	MC7075-120 MC7010-120	MC7075J-120 MC7010J-120	
		100	S54	3/4 1	MC1075-120 MC1010-120	MC1075J-120 MC1010J-120	
		150	S55	3/4 1	MC1575-120 MC1510-120	MC1575J-120 MC1510J-120	
Wall ⑥ — Malleable iron mounting hood and aluminum ballast body. Gasket and screws furnished with fixture. Fits GSU Cast Boxes							
		35	S76	—	MGSW35-120	MGSW35J-120	
		50	S68	—	MGSW50-120	MGSW50J-120	
		70	S62	—	MGSW70-120	MGSW70J-120	
		100	S54	—	MGSW10-120	MGSW10J-120	
		150	S55	—	MGSW15-120	MGSW15J-120	
Wall ⑥⑥ — Class I, Division 2 only. Aluminum mounting hood and ballast body. Gasket and screws furnished with fixture. Fits JBX Cast Boxes							
		35	S76	—	MJBW35-120	MJBW35J-120	
		50	S68	—	MJBW50-120	MJBW50J-120	
		70	S62	—	MJBW70-120	MJBW70J-120	
		100	S54	—	MJBW10-120	MJBW10J-120	
		150	S55	—	MJBW15-120	MJBW15J-120	
25° Stanchion ⑥ — Aluminum mounting hood and ballast body. One hub							
		35	S76	1-1/4 1-1/2	MS35125-120 MS35150-120	MS35125J-120 MS35150J-120	
		50	S68	1-1/4 1-1/2	MS50125-120 MS50150-120	MS50125J-120 MS50150J-120	
		70	S62	1-1/2 1-1/2	MS70125-120 MS70150-120	MS70125J-120 MS70150J-120	
		100	S54	1-1/4 1-1/2	MS10125-120 MS10150-120	MS10125J-120 MS10150J-120	
		150	S55	1-1/4 1-1/2	MS15125-120 MS15150-120	MS15125J-120 MS15150J-120	

① Per NEC 500.6(1), there is no such classification as Class II, Division 2, Group E.

② The MJBW Wall Mount Fixture is suitable for Class I, Division 2, Groups A, B, C and D only.

③ All fixtures on this page comply with UL Standard 844 except MJBW Wall Mount Fixture, which is not suitable for Class II, Division 1.

④ Using cast outlet box with Wall Mount Fixture provides the following clearances: for the globe – JBX box, 1-5/8" from wall; GSU box, 2" from wall; for the refractor – JBX box, 15/16" from wall; GSW box, 1-5/16" from wall. Reflectors cannot be used with the wall mount fixtures.

⑤ Stanchion Mount can be used with standard dome or 30° angle reflector.



⑥ To order fixture with guard, add -G before voltage (example: MA3575G-120).

Mercmaster™ Jr. Luminaires

High Pressure Sodium. Suitable for Use in Wet Locations

UNILETS® for Use with Threaded Metal Conduit. 120 V Integral Ballast. Medium Base Socket for Medium Base Lamps.

<p>NEC: With Globe: 35 W, 50 W: Class I, Division 2, Groups A, B, C, D Class II, Division 1 and 2, Groups E ②, F, G Class III</p>	<p>NEC: 70 W: ① Class I, Division 2, Groups A, B, C, D Class II, Division 1 and 2, Groups E ②, F 100 W, 150 W: ① Class I, Division 2, Groups A, B, C, D</p>	<p>NEC: With Refractor (NEMA V): 35 W, 50 W, 70 W, 100 W: Class I, Division 2, Groups A, B, C, D Class II, Division 1 and 2, Groups E ②, F, G Class III</p>	<p>NEC: 150 W: ① Class I, Division 2, Groups A, B, C, D</p>
--	---	--	--

With Globe	With 8" Refractor	Description	Lamp Watts	ANSI Lamp Type	Catalog Number	
					With Globe ③	With 8" Refractor
Outlet Box Fixture						
		Aluminum ballast housing, complete with aluminum mounting hood. Epoxy clad.	35	S76	MOB35-120	MOB35J-120
			50	S68	MOB50-120	MOB50J-120
		Use with SEH and 3-1/4" or 4" Octagonal Outlet Box. Fixture furnished with mounting plate and gasket. Octagonal boxes not suitable for classified locations.	70	S62	MOB70-120	MOB70J-120
			100	S54	MOB10-120	MOB10J-120
			150	S55	MOB15-120	MOB15J-120

	Lamp Watts	ANSI Lamp Type	Catalog Number
Fixture Units			
	S76	35	MUL35-120
	S68	50	MUL50-120
	S62	70	MUL70-120
	S54	100	MUL100-120
	S55	150	MUL150-120

Ballast Bodies			
	S76	35	MBL35-120
	S68	50	MBL50-120
	S62	70	MBL70-120
	S54	100	MBL100-120
	S55	150	MBL150-120

① Per NEC 500.6(1), there is no such classification as Class II, Division 2, Group E.
 ② The MJBW Wall Mount Fixture is suitable for Class I, Division 2, Groups A, B, C and D only.
 ③ Order JBX or GSU box on following page.

Mercmaster™ Jr. Luminaires

High Pressure Sodium. Suitable for Use in Wet Locations

UNILETS® for Use with Threaded Metal Conduit. 120 V Integral Ballast. Medium Base Socket for Medium Base Lamps.

NEC:

With Globe:
35 W, 50 W:
Class I, Division 2, Groups A, B, C, D
Class II, Division 1 and 2, Groups E ②, F, G
Class III

NEC:

70 W: ①
Class I, Division 2, Groups A, B, C, D
Class II, Division 1 and 2, Groups E ②, F
100 W, 150 W: ①
Class I, Division 2, Groups A, B, C, D













NEC:

With Refractor (NEMA V):
35 W, 50 W, 70 W, 100 W:
Class I, Division 2, Groups A, B, C, D
Class II, Division 1 and 2, Groups E ②, F, G
Class III

NEC:

150 W: ①
Class I, Division 2, Groups A, B, C, D

Mounting Hoods

	Hub Size (Inches)	Catalog Number	
		Aluminum	Malleable Iron
Pendant Mounting Furnished with connection block, gasket and screws			
 VMA	1/2	—	VA50
 VA	3/4	VMA75	VA75
	1	VMA100	VA100
Ceiling Mounting Five Hubs. Furnished with connection block, gasket, screws and four close-up plugs			
 VXHA	1/2	VXHA50-A	VXHA50
	3/4	VXHA75-A	VXHA75
	1	VXHA100-A	VXHA100
Cast/Outlet Box Mounting Furnished with connection block, mounting plate and gasket. Octagonal outlet box not suitable for classified locations. Fits SEH and 3-1/4" or 4" Octagonal Box ③			
 OBVW	Wall ⑥	OBVW1-A	OBVW1
 OBV	Ceiling	OBV1-A	OBV1
GS Round Base – Fits GSU Cast Boxes ④ ⑤ Furnished with connection block, gasket and screws			
 GSW	Wall ⑥	—	GSW2
 GS	Ceiling	—	GS2
JB Round Base – Fits JBX Cast Boxes ④ ⑤ Furnished with connection block, gasket and screws			
 JBW	Wall ⑥	JBW1-A	JBW1
 JB	Ceiling	JB1-A	JB1
Stanchion Mounting ⑦ 25° Stanchion furnished with connection block and screws.			
 MS	1-1/4	MS-125	—
	1-1/2	MS-150	—
JBX Cast Conduit Outlet Boxes ④			
 JBX	Aluminum. 1-5/16" inside depth. Four tapped openings, two close-up plugs and mounting lugs. Use with JBW wall mount fixture and JB round base mounting hoods	1/2	JBX50L-A
		3/4	JBX75L-A
GSU Cast Conduit Outlet Box (Form 20) ⑤			
 GSU-20	Malleable iron. 1-3/4" inside depth. Four 3/4" hubs with four 3/4" to 1/2" reducers, and three 1/2" close-up plugs. Use with GSW wall mount fixture and GS round base mounting hoods	1/2 or 3/4	GSU-20
 GSU-100		1	GSU-100

① The MJBW Wall Mount Fixture is suitable for Class I, Division 2, Groups A, B, C and D only.

② Per NEC 500.6(1), there is no such classification as Class II, Division 2, Group E.

③ Order SEH box from catalog section A and octagonal box from Section OB. To order fixture with guard, add G before voltage (example: MOB35G-120).

④ Order JBX below. Using JBX Box with these fixtures and mounting hoods provides 15/16" clearance from wall with refractor and 1-5/8" clearance from wall with globe.

⑤ Order GSU below. Using GSU Box with these fixtures and mounting hoods provides 1-5/16" clearance from wall with refractor and 2" clearance from wall with globe.

⑥ Reflectors cannot be used with wall mount fixtures. See dimensions for globe or refractor clearance from wall for these fixtures.

⑦ Stanchion mounting hood can be used with standard dome or 30° angle reflector.

Mercmaster™ Jr. Luminaires

High Pressure Sodium. Suitable for Use in Wet Locations

UNILETS® for Use with Threaded Metal Conduit. 120 V Integral Ballast. Medium Base Socket for Medium Base Lamps.

<p>NEC: With Globe: 35 W, 50 W: Class I, Division 2, Groups A, B, C, D Class II, Division 1 and 2, Groups E ②, F, G Class III</p>	<p>NEC: 70 W: ① Class I, Division 2, Groups A, B, C, D Class II, Division 1 and 2, Groups E ②, F 100 W, 150 W: ① Class I, Division 2, Groups A, B, C, D</p>	<p>NEC: With Refractor (NEMA V): 35 W, 50 W, 70 W, 100 W: Class I, Division 2, Groups A, B, C, D Class II, Division 1 and 2, Groups E ②, F, G Class III</p>	<p>NEC: 150 W: ① Class I, Division 2, Groups A, B, C, D</p>
--	---	--	--

	Description	Catalog Number
--	-------------	----------------

Globes – 35 W-150 W



VPGL-1HR



VPGL-2PL

Clear Heat-Resistant Prismatic Glass
 Polycarbonate (100W lamp max.) ④

VPGL-1HR
 VPGL-2PL

	Description	Light Distribution	IES/NEMA Distribution Curves	Catalog Number
--	-------------	--------------------	------------------------------	----------------

Refractors – 35 W-150 W



Closed Prismatic Glass 8" Refractors

NEMA Type II

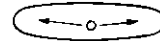

LPJR-2CG

NEMA Type V



LPJR-5CG

	Description	Catalog Number	
		Porcelain	Polyester

Reflectors – 35 W-150 W ③



Standard



30° Angle

Standard (porcelain, 16" dia.; polyester, 16-1/4" dia.)
 30° Angle (porcelain, 12" dia.; polyester, 14-3/8" dia.)

LPR-25ST
 LPR-25AN

LPRP-25ST
 LPRP-25AN

	Description	Catalog Number
--	-------------	----------------

Guards – 35 W-150 W



VPGU-1



LPBG-8

Copperfree Aluminum Guard
 Steel Guard for 8" Refractors

VPGU-1
 LPBG-8

Socket



35 W-150 W (Medium Base)

JRS-100

Gasket



Globe Gasket, Silicone Rubber – 35W-150W

VPGL-GK

① The MJBW Wall Mount Fixture is suitable for Class I, Division 2, Groups A, B, C and D only.
 ② Per NEC 500.6(1), there is no such classification as Class II, Division 2, Group E.
 ③ V-51 reflectors cannot be used with Mercmaster Jr. Fixtures.
 ④ Do not use Polycarbonate Globes in ambients exceeding +25 °C (+77 °F). These globes for burning in vertical base-up position only.

Mercmaster™ Jr. Luminaires

35 W, 50 W, 70 W, 100 W, 150 W

UNILETS® for Use with Threaded Metal Conduit. 120 V Integral Ballast. Medium Base Socket for Medium Base Lamps.

NEC:

With Globe:

35 W, 50 W:

Class I, Division 2, Groups A, B, C, D

Class II, Division 1 and 2, Groups E ②, F, G

Class III

NEC:

70 W: ①

Class I, Division 2, Groups A, B, C, D

Class II, Division 1 and 2, Groups E ②, F

100 W, 150 W: ①

Class I, Division 2, Groups A, B, C, D

NEC:

With Refractor (NEMA V):

35 W, 50 W, 70 W, 100 W:

Class I, Division 2, Groups A, B, C, D

Class II, Division 1 and 2, Groups E ②, F, G

Class III

NEC:

150 W: ①

Class I, Division 2, Groups A, B, C, D

Dimensions in Millimeters (Inches)

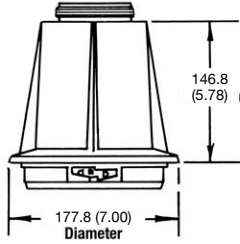

MBL Ballast Body

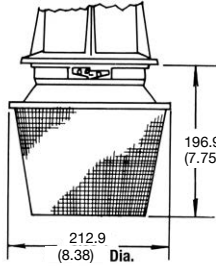

Fixture with 8" Refractor

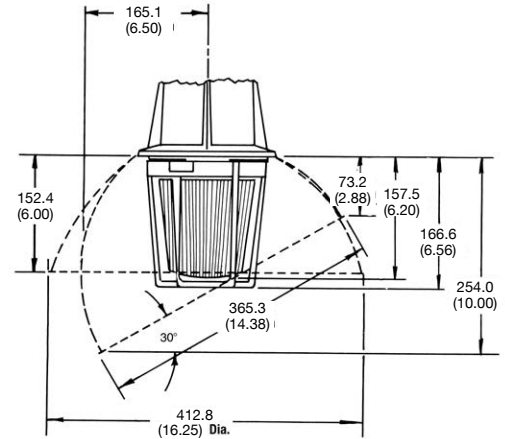

Fixture with Guard and Polyester Reflectors

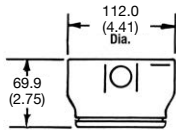

VXHA Ceiling Mount

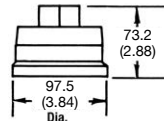

VMA Pendant Mount

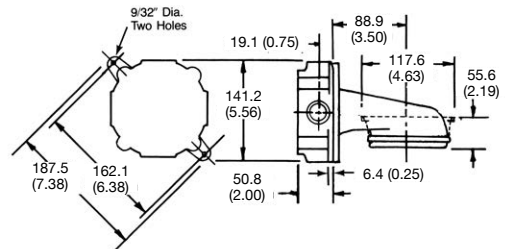

GSW Wall Mount ③ and GS Ceiling Mount with GSU Box ④

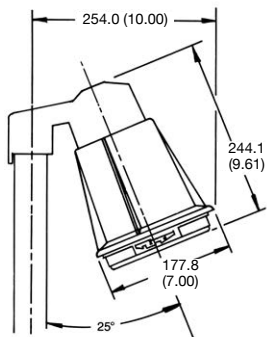

Stanchion Mount ⑥

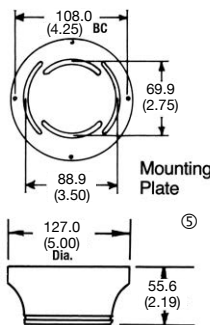

OBV Outlet Box Mount and Mounting Plate

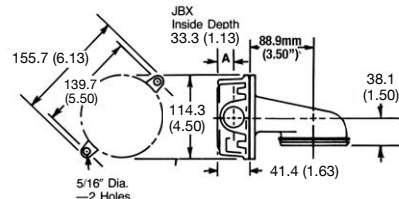

JBW Wall Mount ③ with JBX Box ④

① The MJBW Wall Mount Fixture is suitable for Class I, Division 2, Groups A, B, C and D only.

② Per NEC 500.6(1), there is no such classification as Class II, Division 2, Group E.

③ Mounting holes 9/32" diameter on 5-1/8" centers. Mounting plate is a separate piece furnished with outlet box mount fixture. The 2.75" dimension is for mounting on 3-1/4" octagonal boxes and the 3.50" dimension is for 4" octagonal boxes.

④ Wall mount fixtures provide the following wall clearances: with GSU box – 2" from wall with globe and 1-5/16" from wall with refractor; with JBX box – 1-5/8" from wall with globe and 15/16" from wall with refractor. Reflectors cannot be used with wall mount fixtures.

⑤ Order GSU or JBX box separately.

⑥ Standard dome or 30° angle reflectors can be used with stanchion mount.

Code•Master™ 2 HID Factory Sealed Luminaires

Explosionproof, Dust-Ignitionproof

Integrally Ballasted. 50 W, 70 W, 100 W, 150 W, 250 W, 400 W HPS; 175 W, 250 W, 320 W, 350 W, 400 W PSMH; 175 W, 250 W, 400 W MH .

Mogul Base. For use with threaded metal conduit.

NEC:

Class I, Division 1 and 2, Groups C, D
Class II, Division 1 and 2, Groups E, F, G
Class III
Marine Type Electric Fixtures
Outside Type (Salt Water)

CEC:

Class I, Division 1 and 2, Groups B, C, D
Class I, Zone 1 and 2; IIB, IIA
Class II, Division 1, Groups E, F, G
Class II, Division 2, Groups F, G
Class III

CEC:

CSA Type 4X
Exd IIB, Zone 1

Applications

- Ideal for use in chemical and petrochemical plants, such as manufacturers of plastics, paints and thinners; in refineries; and in other process areas where ignitable vapors, dust, moisture and corrosive elements may be present.
- Suitable for use in wet locations.

Features

- Fixtures operate safely in high ambient temperatures. For example, in Class I areas the 150 W HPS fixture operates at a maximum temperature of +120 °C (+248 °F) in a +65 °C (+149 °F) ambient [+100 °C (+212 °F) temperature in a +40 °C (+104 °F) ambient].
- Arrangement of heat-producing components results in more efficient heat dissipation for cooler fixture operation.
- “Wireless” design. Threading of fixture unit onto mounting hood makes electrical connection. Only wiring required is attaching two wires to connection block in mounting hood.
- Connection block is easily wired: (a) loosen two screws, (b) make wire connections and (c) re-position connection block.
- Safe, easy servicing without disconnecting any wiring. “Wireless” fixture unit easily threads off mounting hood for convenient servicing or for immediate replacement with a “stand-by” unit.
- Acme double-lead threads speed installation and fixture removal from mounting hood — only half as many turns are required as for single-lead threads. The threads do not stick or gall, eliminating the troublesome problems often encountered with single lead threads during fixture unit removal.
- All threaded joints are flame-tight.
- Integrally ballasted HID lighting fixtures; separate ballasts not required.
- Factory sealed. External seals not required.
- Strategic location of lamp socket in combination with the interior prism design of the glass globe provides optimum light distribution and control.
- Superior corrosion resistance, with epoxy powder coat finish.
- Porcelain socket with nickel-plated phosphor bronze screw shell. Assures long trouble-free operation in high ambient areas.
- Choice of mountings: pendant, ceiling, bracket and stanchion.
- Fiberglass-reinforced polyester reflectors, in standard dome, deep dome or 30° angle, are ideal in installations where luminaire is subject to exceptionally severe corrosive atmospheres. The high bay aluminum reflector is indicated in installations where mounting height from work plane ranges from 20 feet/6 meters and higher.
- Optional guards protect globes from damage. Secured to fixture with three screws.
- Light sources: high pressure sodium, pulse start metal halide or metal halide. HPS is excellent where long lamp life is required. HPS provides high lumens per watt and is less expensive to operate. PSMH/MH is desirable where colors of illuminated areas must be close to natural. PSMH/MH provides better color rendition, increased lumen output, longer lamp life, and faster restrike after momentary power interruption.
- A wide range of ballasts and voltages are available for both domestic and export applications.
- Ballasts operate at low temperatures – PSMH: -29 °C (-20 °F); HPS: -40 °C (-40 °F); MH: -35 °C (-31 °F).



- 50 W through 150 W high pressure sodium ballasts are high reactance, high power factor type.

Standard Materials

- Ballast bodies and guards: copperfree (4/10 of 1% max.) aluminum
- Pendant mounting hoods: diecast copperfree (4/10 of 1% max.) aluminum
- Ceiling, bracket and stanchion mounting hoods: sand cast copperfree (4/10 of 1% max.) aluminum
- Reflectors: aluminum or fiberglass reinforced polyester

Standard Finishes

- Ballast bodies, guards and mounting hoods: epoxy powder coat finish, electrostatically applied for complete, uniform corrosion protection

Options

- Fuses for field installation can be ordered by catalog number from fuse kit table.
- Quartz Auxiliary Emergency Lamp for PSMH/MH and HPS fixtures. Relay switch installed in fixture. Add suffix **-E** to fixture catalog number. ①
- Hot Restrike Option available for 50 W through 150 W HPS only. Add suffix **-R**.
- Smart Starter Option available for 50 W through 400 W HPS and PSMH/MH. Add suffix **-S**.

NEC/CEC Certifications and Compliances

- UL Standard: UL 1598, UL 844
- UL Listed: E10444
- CSA Standard: C22.2 No. 250, C22.2 No. 137
- CSA Certified: 025428

① Quartz Auxiliary Emergency Lamps for PSMH/MH and HPS fixtures are for ordinary locations only.

Code•Master™ 2 HID Factory Sealed Luminaires

Explosionproof, Dust-Ignitionproof

Integrally Ballasted. 50 W, 70 W, 100 W, 150 W, 250 W, 400 W HPS; 175 W, 250 W, 320 W, 350 W, 400 W PSMH; 175 W, 250 W, 400 W MH.

Mogul Base. For use with threaded metal conduit.

NEC:

Class I, Division 1 and 2, Groups C, D
Class II, Division 1 and 2, Groups E, F, G
Class III
Marine Type Electric Fixtures
Outside Type (Salt Water)

CEC:

Class I, Division 1 and 2, Groups B, C, D
Class I, Zone 1 and 2; IIB, IIA
Class II, Division 1, Groups E, F, G
Class II, Division 2, Groups F, G
Class III

CEC:

CSA Type 4X
Exd IIB, Zone 1

Classified Area Suitability of Code•Master 2 Series HID Fixtures — Suitability includes use of reflector

Lamp Type	Lamp Watts	Supply Wire °C (°F)	Ambient Temp °C (°F)	Class I, Division 1 and 2 With Globe or with Globe and Reflector UL/NEC/CEC Temp. Ident. No.			Class II, Division 1 and 2 With Globe or with Globe and Reflector UL/NEC/CEC Temp. Ident. No. ①	
				Nameplate Marking	NEC Groups	CEC Groups	Nameplate Marking	Groups
High Pressure Sodium	50	60 (140)	40 (104)	T6	C,D	B, C, D	T4	E,F,G
	50	75 (167)	55 (131)	T5	C,D	B, C, D	—	—
	50	85 (185)	65 (149)	T5	C,D	B, C, D	—	—
	70	60 (140)	40 (104)	T6	C,D	B, C, D	T4	E,F,G
	70	75 (167)	55 (131)	T5	C,D	B, C, D	—	—
	70	85 (185)	65 (149)	T5	C,D	B, C, D	—	—
	100	60 (140)	40 (104)	T5	C,D	B, C, D	T4	E,F,G
	100	75 (167)	55 (131)	T5	C,D	B, C, D	—	—
	100	85 (185)	65 (149)	T4A	C,D	B, C, D	—	—
	150	60 (140)	40 (104)	T5	C,D	B, C, D	T3A	E,F
	150	75 (167)	55 (131)	T4A	C,D	B, C, D	T3	—
	250	75 (167)	40 (104)	T3C	C,D	B, C, D	—	—
	250	75 (167)	55 (131)	T3C	C,D	B, C, D	—	—
	400	85 (185)	40 (104)	T3C	C,D	B, C, D	—	—
Pulse Start Metal Halide	175	75 (167)	40 (104)	T4	C,D	B, C, D	T3C	E,F,G
	250	75 (167)	40 (104)	T4	C,D	B, C, D	T3A	E,F
	320	75 (167)	40 (104)	T3C	C,D	B, C, D	—	—
	350	75 (167)	40 (104)	T3C	C,D	B, C, D	—	—
	400	75 (167)	40 (104)	T3C	C,D	B, C, D	—	—
Metal Halide ②	175	75 (167)	40 (104)	T4	—	B, C, D	T3C	E, F, G
	250	75 (167)	40 (104)	T4	—	B, C, D	T3A	E, F
	400	75 (167)	40 (104)	T3C	—	B, C, D	—	—

“T” Numbers Represent the Maximum Surface Temperature for Class I, Division 1 Locations and Maximum Surface Temperature Under Dust Blanket for Class II, Division 1 Locations.

“T” Number	T1	350	325	T2	T2A	T2B	T2C	T2D	T3	T3A	T3B	T3C	T4	T4A	T5	T6
Temp. Range (°C)	351-450	326-350	301-325	281-300	261-280	231-260	216-230	201-215	181-200	166-180	161-165	136-160	121-135	101-120	86-100	85
Temp. Range (°F)	664-842	619-662	574-617	538-572	502-536	448-500	421-446	394-419	358-392	331-356	322-329	277-320	250-275	214-248	187-12	185

NOTE: The maximum operating temperature of the fixture must not exceed the ignition temperature of the gas, vapor or dust to be encountered per the National Electrical Code and the Canadian Electrical Code.

① Applies to Code•Master 2 only.

② Mercury vapor and metal halide luminaires are not available for purchase within the United States. Please check with your countries governing legislation regarding allowable lamp types before ordering.

Code•Master™ 2 HID Factory Sealed Luminaires

Explosionproof, Dust-Ignitionproof. Groups C and D Applications

Integrally Ballasted. 50 W, 70 W, 100 W, 150 W, 250 W, 400 W HPS; 175 W, 250 W, 320 W, 350 W, 400 W PSMH.

Mogul Base. For use with threaded metal conduit.

NEC:

Class I, Division 1 and 2, Groups C, D ♦

Class II, Division 1 and 2, Groups E, F, G

Class III

Marine Type Electric Fixtures

Outside Type (Salt Water)

HID/AREA: NEC/CEC EXPLOSIONPROOF



Pendant — One Hub, Rigid or Flexible Mounting

Lamp Watts	ANSI Lamp Type		Hub Size (Inches)	Catalog Number ②③	
	HPS	PSMH		HPS	PSMH
50	S68	—	3/4	CLP5075 ①	—
			1	CLP5010 ①	—
70	S62	—	3/4	CLP7075	—
			1	CLP7010	—
100	S54	—	3/4	CLP1075	—
			1	CLP1010	—
150	S55	—	3/4	CLP1575	—
			1	CLP1510	—
175	—	M152	3/4	—	CPP1775
			1	—	CPP1710
250	S50	M153	3/4	CLP2575	CPP2575
			1	CLP2510	CPP2510
320	—	M154	3/4	—	CPP3275
			1	—	CPP3210
350	—	M131	3/4	—	CPP3575
			1	—	CPP3510
400	S51	M155	3/4	CLP4075	CPP4075
			1	CLP4010	CPP4010

Ceiling — Four Hubs, Three Close-Up Plugs



50	S68	—	3/4	CLC5075 ①	—
			1	CLC5010 ①	—
70	S62	—	3/4	CLC7075	—
			1	CLC7010	—
100	S54	—	3/4	CLC1075	—
			1	CLC1010	—
150	S55	—	3/4	CLC1575	—
			1	CLC1510	—
175	—	M152	3/4	—	CPC1775
			1	—	CPC1710
250	S50	M153	3/4	CLC2575	CPC2575
			1	CLC2510	CPC2510
320	—	M154	3/4	—	CPC3275
			1	—	CPC3210
350	—	M131	3/4	—	CPC3575
			1	—	CPC3510
400	S51	M155	3/4	CLC4075	CPC4075
			1	CLC4010	CPC4010

① Add voltage **-MT** for 120/208/240/277 V. For 480 V, contact your sales representative.

② Add voltage suffix **-MT** for -120/208/240/277 V; or **-480** for 480 V.

③ To order fixture with guard, add suffix **-G** (before adding voltage suffix).

♦ Shaded items are suitable for Class I, Group D ONLY.

Code•Master™ 2 HID Factory Sealed Luminaires

Explosionproof, Dust-Ignitionproof. Groups C and D Applications

Integrally Ballasted. 50 W, 70 W, 100 W, 150 W, 250 W, 400 W HPS; 175 W, 250 W, 320 W, 350 W, 400 W PSMH.

Mogul Base. For use with threaded metal conduit.

NEC:



Class I, Division 1 and 2, Groups C, D♦

Class II, Division 1 and 2, Groups E, F, G

Class III

Marine Type Electric Fixtures

Outside Type (Salt Water)

	Lamp Watts	ANSI Lamp Type		Hub Size (Inches)	Catalog Number ②③	
		HPS	PSMH		HPS	PSMH
Bracket - Four Hubs, Three Close-Up Plugs						
	50	S68	—	3/4	CLB5075 ①	—
				1	CLB5010 ①	—
	70	S62	—	3/4	CLB7075	—
				1	CLB7010	—
	100	S54	—	3/4	CLB1075	—
				1	CLB1010	—
	150	S55	—	3/4	CLB1575	—
				1	CLB1510	—
	175	—	M152	3/4	—	CPB1775 ②
				1	—	CPB1710 ②
	250	S50	M153	3/4	CLB2575	CPB2575 ②
				1	CLB2510	CPB2510 ②
	320	—	M154	3/4	—	CPB3275 ②
				1	—	CPB3210 ②
	350	—	M131	3/4	—	CPB3575 ②
				1	—	CPB3510 ②
400	S51	M155	3/4	CLB4075	CPB4075 ②	
			1	CLB4010	CPB4010 ②	
25° Stanchion - One Hub						
	50	S68	—	1-1/4 or 1-1/2 ④	CLS50150 ①	—
				1-1/4 or 1-1/2 ④	CLS70150	—
	100	S54	—	1-1/4 or 1-1/2 ④	CLS10150	—
				1-1/4 or 1-1/2 ④	CLS15150	—
	175	—	M152	1-1/4 or 1-1/2 ④	—	CPS17150 ②
				1-1/4 or 1-1/2 ④	CLS25150	CPS25150 ②
	320	—	M154	1-1/4 or 1-1/2 ④	—	CPS32150 ②
				1-1/4 or 1-1/2 ④	—	CPS35150 ②
	400	S51	M155	1-1/4 or 1-1/2 ④	CLS40150 ②	CPS40150 ②

① Add voltage **-MT** for 120/208/240/277 V. For 480 V, contact your sales representative.

② Add voltage suffix **-MT** for -120/208/240/277 V; or **-480** for 480 V.

③ To order fixture with guard, add suffix **-G** (before adding voltage suffix).

④ 1-1/2" tapped hub furnished with 1-1/2" to 1-1/4" reducer.

♦ Shaded items are suitable for Class I, Group D ONLY.

Code•Master™ 2 HID Factory Sealed Luminaires

Explosionproof, Dust-Ignitionproof. Groups B, C and D Applications

Integrally Ballasted. 70 W, 100 W, 150 W, 250 W, 400 W HPS; 175 W, 250 W, 320 W, 350 W, 400 W PSMH; 175 W, 250 W, 400 W MH.

Mogul Base. For use with threaded metal conduit.

CEC:
Class I, Division 1 and 2, Groups B, C, D ♦
Class I, Zone 1 and 2; IIB, IIA
Class II, Division 1, Groups E, F, G
Class II, Division 2, Groups F, G
Class III

CEC:
CSA Type 4X
Exd IIB, Zone 1

Lamp Watts	ANSI Lamp Type			Hub Size (Inches)	Catalog Number ①②		
	HPS	PSMH	MH		HPS	PSMH	MH ③

Pendant — One Hub, Rigid or Flexible Mounting



70	S62	—	—	3/4	CLP7075TTCN	—	—
				1	CLP7010TTCN	—	—
100	S54	—	—	3/4	CLP1075TTCN	—	—
				1	CLP1010TTCN	—	—
150	S55	—	—	3/4	CLP1575TTCN	—	—
				1	CLP1510TTCN	—	—
175	—	M152	M57	3/4	—	CPP1775TTCN	CHP1775TTCN
				1	—	CPP1710TTCN	CHP1710TTCN
250	S50	M153	M58	3/4	CLP2575TTCN	CPP2575TTCN	CHP2575TTCN
				1	CLP2510TTCN	CPP2510TTCN	CHP2510TTCN
320	—	M154	—	3/4	—	CPP3275TTCN	—
				1	—	CPP3210TTCN	—
350	—	M131	—	3/4	—	CPP3575TTCN	—
				1	—	CPP3510TTCN	—
400	S51	M155	M59	3/4	CLP4075TTCN	CPP4075TTCN	CHP4075TTCN
				1	CLP4010TTCN	CPP4010TTCN	CHP4010TTCN

Ceiling — Four Hubs, Three Close-Up Plugs



70	S62	—	—	3/4	CLC7075TTCN	—	—
				1	CLC7010TTCN	—	—
100	S54	—	—	3/4	CLC1075TTCN	—	—
				1	CLC1010TTCN	—	—
150	S55	—	—	3/4	CLC1575TTCN	—	—
				1	CLC1510TTCN	—	—
175	—	M152	M57	3/4	—	CPC1775TTCN	CHC1775TTCN
				1	—	CPC1710TTCN	CHC1710TTCN
250	S50	M153	M58	3/4	CLC2575TTCN	CPC2575TTCN	CHC2575TTCN
				1	CLC2510TTCN	CPC2510TTCN	CHC2510TTCN
320	—	M154	—	3/4	—	CPC3275TTCN	—
				1	—	CPC3210TTCN	—
350	—	M131	—	3/4	—	CPC3575TTCN	—
				1	—	CPC3510TTCN	—
400	S51	M155	M59	3/4	CLC4075TTCN	CPC4075TTCN	CHC4075TTCN
				1	CLC4010TTCN	CPC4010TTCN	CHC4010TTCN

① Change voltage suffix **-TT** (120/277/347 V) to **-MT** for 120/208/240/277 V, **-C2** for 208 V, **-C3** for 240 V, **-C6** for 480 V, or **-C7** for 600 V. These voltage suffixes have CSA Certification only.

② To order fixture with guard, add suffix **-G** (before adding voltage suffix).

③ Mercury vapor and metal halide luminaires are not available for purchase within the United States. Please check with your countries governing legislation regarding allowable lamp types before ordering.

♦ Shaded items are suitable for Class I, Group D ONLY.

Code•Master™ 2 HID Factory Sealed Luminaires

Explosionproof, Dust-Ignitionproof. Groups B, C and D Applications

Integrally Ballasted. 70 W, 100 W, 150 W, 250 W, 400 W HPS; 175 W, 250 W, 320 W, 350 W, 400 W PSMH; 175 W, 250 W, 400 W MH.

Mogul Base. For use with threaded metal conduit.

CEC:

Class I, Division 1 and 2, Groups B, C, D ♦
 Class I, Zone 1 and 2; IIB, IIA
 Class II, Division 1, Groups E, F, G
 Class II, Division 2, Groups F, G
 Class III

CEC:

CSA Type 4X
 Exd IIB, Zone 1

	Lamp Watts	ANSI Lamp Type			Hub Size (Inches)	Catalog Number ①②		
		HPS	PSMH	MH		HPS	PSMH	MH ③
Bracket - Four Hubs, Three Close-Up Plugs								
	70	S62	—	—	3/4	CLB7075TTCN	—	—
					1	CLB7010TTCN	—	—
	100	S54	—	—	3/4	CLB1075TTCN	—	—
					1	CLB1010TTCN	—	—
	150	S55	—	—	3/4	CLB1575TTCN	—	—
					1	CLB1510TTCN	—	—
	175	—	M152	M57	3/4	—	CPB1775TTCN	CHB1775TTCN
					1	—	CPB1710TTCN	CHB1710TTCN
	250	S50	M153	M58	3/4	CLB2575TTCN	CPB2575TTCN	CHB2575TTCN
					1	CLB2510TTCN	CPB2510TTCN	CHB2510TTCN
	320	—	M154	—	3/4	—	CPB3275TTCN	—
					1	—	CPB3210TTCN	—
	350	—	M131	—	3/4	—	CPB3575TTCN	—
					1	—	CPB3510TTCN	—
	400	S51	M155	M59	3/4	CLB4075TTCN	CPB4075TTCN	CHB4075TTCN
					1	CLB4010TTCN	CPB4010TTCN	CHB4010TTCN

25° Stanchion - One Hub



70	S62	—	—	1-1/4 or 1-1/2 ④	CLS70150TTCN	—	—
100	S54	—	—	1-1/4 or 1-1/2 ④	CLS10150TTCN	—	—
150	S55	—	—	1-1/4 or 1-1/2 ④	CLS15150TTCN	—	—
175	—	M152	M57	1-1/4 or 1-1/2 ④	—	CPS17150TTCN	CHS17150TTCN
250	S50	M153	M58	1-1/4 or 1-1/2 ④	CLS25150TTCN	CPS25150TTCN	CHS25150TTCN
320	—	M154	—	1-1/4 or 1-1/2 ④	—	CPS32150TTCN	—
350	—	M131	—	1-1/4 or 1-1/2 ④	—	CPS35150TTCN	—
400	S51	M155	M59	1-1/4 or 1-1/2 ④	CLS40150TTCN	CPS40150TTCN	CHS40150TTCN

① Change voltage suffix -TT (120/277/347 V) to -MT for 120/208/240/277 V, -C2 for 208 V, -C3 for 240 V, -C6 for 480 V, or -C7 for 600 V. These voltage suffixes have CSA Certification only.

② To order fixture with guard, add suffix -G (before adding voltage suffix).

③ Mercury vapor and metal halide luminaires are not available for purchase within the United States. Please check with your countries governing legislation regarding allowable lamp types before ordering.

④ 1-1/2" tapped hub furnished with 1-1/2" to 1-1/4" reducer.

♦ Shaded items are suitable for Class I, Group D ONLY.

Code•Master™ 2 HID Factory Sealed Luminaires

Explosionproof, Dust-Ignitionproof

Integrally Ballasted. 50 W, 70 W, 100 W, 150 W, 250 W, 400 W HPS; 175 W, 250 W, 320 W, 350 W, 400 W PSMH; 175 W, 250 W, 400 W MH.





Mogul Base. For use with threaded metal conduit.

NEC:
 Class I, Division 1 and 2, Groups C, D ♦
 Class II, Division 1 and 2, Groups E, F, G
 Class III
 Marine Type Electric Fixtures
 Outside Type (Salt Water)

CEC:
 Class I, Division 1 and 2, Groups B, C, D ♦
 Class I, Zone 1 and 2; IIB, IIA
 Class II, Division 1, Groups E, F, G
 Class II, Division 2, Groups F, G
 Class III

CEC:
 CSA Type 4X
 Exd IIB, Zone 1

Mounting Hoods

	Hub Size (Inches)	Catalog Number
Pendant — One Hub		
	3/4	CAP-75
	1	CAP-100
Ceiling — Four Hubs, Three Close-Up Plugs		
	3/4	CAC-75
	1	CAC-100
Bracket — Four Hubs, Three Close-Up Plugs		
	3/4	CALB-75
	1	CALB-100
25° Stanchion — One Hub		
	1-1/4 or 1-1/2 ①	CAS-150

Mounting Adapter with Connection Block



Permits use of existing A-51 mounting hoods (AAC Ceiling or AALB Bracket) with the new Code•Master 2 Fixture Unit. After removing existing fixture unit and adapter, screw in the new CMAD-1 Adapter. Then thread new fixture unit into the CMAD-1.

CMAD-1

Fixture Units

Ballast body with globe. Indicate voltage desired by adding voltage suffix to fixture unit catalog number listed below.

Type	Lamp Watts	Fixture Unit Number	Add Voltage Suffixes		
			120/208/240/277	120/277/347 ③	480 V
High Pressure Sodium High Power Factor (Min. P.F. 90%)	50	CMBL50	MT	TTCN	—
	70	CMBL70	MT	TTCN	48
	100	CMBL100	MT	TTCN	48
	150	CMBL150	MT	TTCN	48
	250	CMBL250	MT	TTCN	48
Pulse Start Metal Halide Constant Wattage (Min. P.F. 90%)	400	CMBL400	MT	TTCN	48
	175	CMBP175	MT	TTCN	48
	250	CMBP250	MT	TTCN	48
	320	CMBP320	MT	TTCN	48
Metal Halide ④ Constant Wattage (Min. P.F. 90%)	350	CMBP350	MT	TTCN	48
	400	CMBP400	MT	TTCN	48
	175	CMBH175	MT	TT	C6
Metal Halide ④ Constant Wattage (Min. P.F. 90%)	250	CMBH250	MT	TT	C6
	400	CMBH400	MT	TT	C6

① 1-1/2" Tapped hub furnished with 1-1/2" to 1-1/4" reducer.

② Add suffix **-R** for "Hot Restrike" and **-S** for "Smart Starter" options.

③ Change voltage suffix **-TTCN** to **-MTCN** for 120/208/240/277 V, **-C2** for 208 V, **-C3** for 240 V, **-C6** for 480 V, or **-C7** for 600 V. These voltage suffixes have CSA Certification only.

④ Mercury vapor and metal halide luminaires are not available for purchase within the United States. Please check with your countries governing legislation regarding allowable lamp types before ordering.

♦ Shaded items are suitable for Class I, Group D ONLY.

HID/AREA: NEC/CEC EXPLOSIONPROOF

Appleton

Code•Master™ 2 HID Factory Sealed Luminaires

Explosionproof, Dust-Ignitionproof

Integrally Ballasted. 50 W, 70 W, 100 W, 150 W, 250 W, 400 W HPS; 175 W, 250 W, 320 W, 350 W, 400 W PSMH; 175 W, 250 W, 400 W MH.

Mogul Base. For use with threaded metal conduit.

NEC:





Class I, Division 1 and 2, Groups C, D
 Class II, Division 1 and 2, Groups E, F, G
 Class III
 Marine Type Electric Fixtures
 Outside Type (Salt Water)

CEC:

Class I, Division 1 and 2, Groups B, C, D
 Class I, Zone 1 and 2; IIB, IIA
 Class II, Division 1, Groups E, F, G
 Class II, Division 2, Groups F, G
 Class III

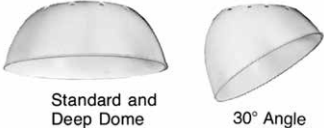
CEC:

CSA Type 4X
 Exd IIB, Zone 1

		Description	Catalog Number
Polyester Reflectors — 50 W - 400 W			
 <p>Standard and Deep Dome</p> <p>30° Angle</p>	Standard Dome	CMR-4ST	
	Deep Dome	CMR-4DD	
	30° Angle	CMR-4AN	
Aluminum High Bay Reflectors — 50 W - 400 W			
		CMR-4HB	
Prismatic Glass Globes — 50 W - 400 W			
	50, 70, 100, 150 W HPS; 175, 250 W PSMH; 175, 250 W MH	CGL-250	
	250, 400 W HPS; 320, 350, 400 W PSMH; 400 W MH	CGL-400	
Aluminum Guards — 50 W - 400 W			
	50, 70, 100, 150 W HPS; 175, 250 W PSMH; 175, 250 W MH	CGU2	
	250, 400 W HPS; 320, 350, 400 W PSMH; 400 W MH	CGU4	
Replacement Sockets — 50 W - 400 W (Mogul Base)			
 <p>VPT-7</p>	For all Code•Master 2 HID fixtures	CMS-400	
	Connection Block – 50 W through 400 W		
	For all Code•Master 2 HID fixtures	VPT-7	
Quartz Emergency Option for Pulse Start Metal Halide and High Pressure Sodium Fixtures			
Fixtures can be supplied with a socket to accept a 150 W or 250 W, 120 V quartz lamp (lamp not included). This D.C. bayonet base socket is in addition to the standard lamp socket, independent of the lighting fixture voltage.			Add suffix -E
HPS Hot Restrike			
Restrikes HPS lamp immediately when power is restored after a momentary power interruption.			Add suffix -R
Optional for fixture watts of 50, 70, 100 or 150 (HPS only)			
HPS Smart Starter			
Smart Starter is for HPS fixtures only. Incorporates a 1-1/2-minute timer and performs as a conventional starter to normally start lamp. Removes itself from circuit if lamp burns out or is removed from socket. Eliminates starter failures caused by prolonged operation with cycling or failing lamps and simplifies finding their location which reduces maintenance and repair costs.			Add suffix -S
Optional for all HPS fixtures.			

HID/AREA: NEC/CEC EXPLOSIONPROOF



Code•Master™ 2 HID Factory Sealed Luminaires

Explosionproof, Dust-Ignitionproof

Integrally Ballasted. 50 W, 70 W, 100 W, 150 W, 250 W, 400 W HPS; 175 W, 250 W, 320 W, 350 W, 400 W PSMH; 175 W, 250 W, 400 W MH.

Mogul Base. For use with threaded metal conduit.

NEC:
 Class I, Division 1 and 2, Groups C, D
 Class II, Division 1 and 2, Groups E, F, G
 Class III
 Marine Type Electric Fixtures
 Outside Type (Salt Water)

CEC:
 Class I, Division 1 and 2, Groups B, C, D
 Class I, Zone 1 and 2; IIB, IIA
 Class II, Division 1, Groups E, F, G
 Class II, Division 2, Groups F, G
 Class III

CEC:
 CSA Type 4X
 Exd IIB, Zone 1

HID/AREA: NEC/CEC EXPLOSIONPROOF

Appleton

Lamp	High Pressure Sodium ①		Ballast Amps Pulse Start Metal Halide Super CWA		Metal Halide CWA		Fuse Quantity Required	Fuse Kit Catalog Number				
	Watts	Volts	Start	Operating	Start	Operating		Start	Operating	HPS	PSMH	MH ②
50	120		0.58	0.58	—	—	—	—	1	CF-5	—	—
	208		0.35	0.33	—	—	—	—	2	CF-3	—	—
	240		0.31	0.29	—	—	—	—	2	CF-3	—	—
	277		0.25	0.25	—	—	—	—	1	CF-2	—	—
	347		—	—	—	—	—	—	—	—	—	—
	480		—	—	—	—	—	—	—	—	—	—
70	120		0.90	0.82	—	—	—	—	1	CF-5	—	—
	208		0.50	0.48	—	—	—	—	2	CF-3	—	—
	240		0.44	0.44	—	—	—	—	2	CF-3	—	—
	277		0.35	0.36	—	—	—	—	1	CF-2	—	—
	347		0.30	0.30	—	—	—	—	1	CF-2	—	—
	480		0.21	0.21	—	—	—	—	2	CF-2	—	—
100	120		1.30	1.15	—	—	—	—	1	CF-8	—	—
	208		0.76	0.67	—	—	—	—	2	CF-5	—	—
	240		0.66	0.58	—	—	—	—	2	CF-5	—	—
	277		0.60	0.50	—	—	—	—	1	CF-3	—	—
	347		0.45	0.39	—	—	—	—	1	CF-3	—	—
	480		0.33	0.29	—	—	—	—	2	CF-3	—	—
150	120		2.00	1.66	—	—	—	—	1	CF-10	—	—
	208		1.16	0.96	—	—	—	—	2	CF-5	—	—
	240		1.00	0.83	—	—	—	—	2	CF-5	—	—
	277		0.88	0.75	—	—	—	—	1	CF-5	—	—
	347		0.52	0.56	—	—	—	—	1	CF-5	—	—
	480		0.50	0.44	—	—	—	—	2	CF-3	—	—
175	120		—	—	1.10	1.86	1.30	1.80	1	—	CF-5	CF-5
	208		—	—	0.75	1.23	0.75	1.10	2	—	CF-3	CF-3
	240		—	—	0.65	0.98	0.65	0.90	2	—	CF-3	CF-3
	277		—	—	0.55	0.87	0.55	0.80	1	—	CF-2	CF-2
	347		—	—	0.25	0.65	0.50	0.65	1	—	CF-2	CF-2
	480		—	—	0.25	0.50	—	—	2	—	CF-2	—
250	120		1.75	2.70	1.96	2.50	1.20	2.60	1	CF-8	CF-8	CF-8
	208		1.00	1.50	1.13	1.45	0.65	1.50	2	CF-5	CF-5	CF-5
	240		0.85	1.30	0.98	1.25	0.60	1.30	2	CF-5	CF-5	CF-5
	277		0.75	1.15	0.85	1.10	0.50	1.12	1	CF-5	CF-3	CF-3
	347		0.60	0.93	0.62	0.90	0.80	0.90	1	CF-5	CF-3	CF-3
	480		0.40	0.65	0.32	0.67	—	—	2	CF-2	CF-2	—
320	120		—	—	3.30	3.25	—	—	1	—	CF-8	—
	208		—	—	1.90	1.90	—	—	2	—	CF-6	—
	240		—	—	1.60	1.65	—	—	2	—	CF-5	—
	277		—	—	1.40	1.40	—	—	1	—	CF-5	—
	347		—	—	0.70	1.10	—	—	1	—	CF-5	—
	480		—	—	0.45	0.85	—	—	2	—	CF-3	—
350	120		—	—	3.60	3.70	—	—	1	—	CF-10	—
	208		—	—	2.10	2.10	—	—	2	—	CF-8	—
	240		—	—	1.80	1.80	—	—	2	—	CF-5	—
	277		—	—	1.60	1.60	—	—	1	—	CF-5	—
	347		—	—	0.70	1.01	—	—	1	—	CF-5	—
	480		—	—	0.60	0.90	—	—	2	—	CF-3	—
400	120		3.10	3.90	3.50	4.00	3.25	4.00	1	CF-15	CF-10	CF-10
	208		1.80	2.25	2.00	2.30	1.90	2.30	2	CF-8	CF-8	CF-8
	240		1.60	1.95	1.75	2.00	1.65	2.00	2	CF-5	CF-5	CF-5
	277		1.35	1.70	1.50	1.75	1.40	1.75	1	CF-5	CF-5	CF-5
	347		1.00	1.32	1.10	1.35	1.20	1.40	1	CF-5	CF-5	CF-5
	480		0.80	1.00	0.75	1.00	—	—	2	CF-5	CF-3	—

Fuse Kit includes fuse, fuse holder and necessary hardware for field installation. Mounts easily in ballast body with one screw. Order one fuse for 120 and 277 V, and 2 fuses for 208, 240 and 480 V. CF-2 = 2 amp; CF-3 = 3 amp; CF-5 = 5 amp; CF-6 = 6 amp; CF-8 = 8 amp; CF-10 = 10 amp

① 50 through 150 W HPS have H.P.F. High Reactance ballasts; 250 W and 400 W HPS have CWA ballasts.

② Mercury vapor and metal halide luminaires are not available for purchase within the United States. Please check with your countries governing legislation regarding allowable lamp types before ordering.

Code•Master™ 2 HID Factory Sealed Luminaires

Explosionproof, Dust-Ignitionproof

Integrally Ballasted. 50 W, 70 W, 100 W, 150 W, 250 W, 400 W HPS; 175 W, 250 W, 320 W, 350 W, 400 W PSMH; 175 W, 250 W, 400 W MH.

Mogul Base. For use with threaded metal conduit.

NEC:

Class I, Division 1 and 2, Groups C, D
 Class II, Division 1 and 2, Groups E, F, G
 Class III
 Marine Type Electric Fixtures
 Outside Type (Salt Water)

CEC:

Class I, Division 1 and 2, Groups B, C, D
 Class I, Zone 1 and 2; IIB, IIA
 Class II, Division 1, Groups E, F, G
 Class II, Division 2, Groups F, G
 Class III

CEC:

CSA Type 4X
 Exd IIB, Zone 1

Dimensions in Millimeters (Inches)

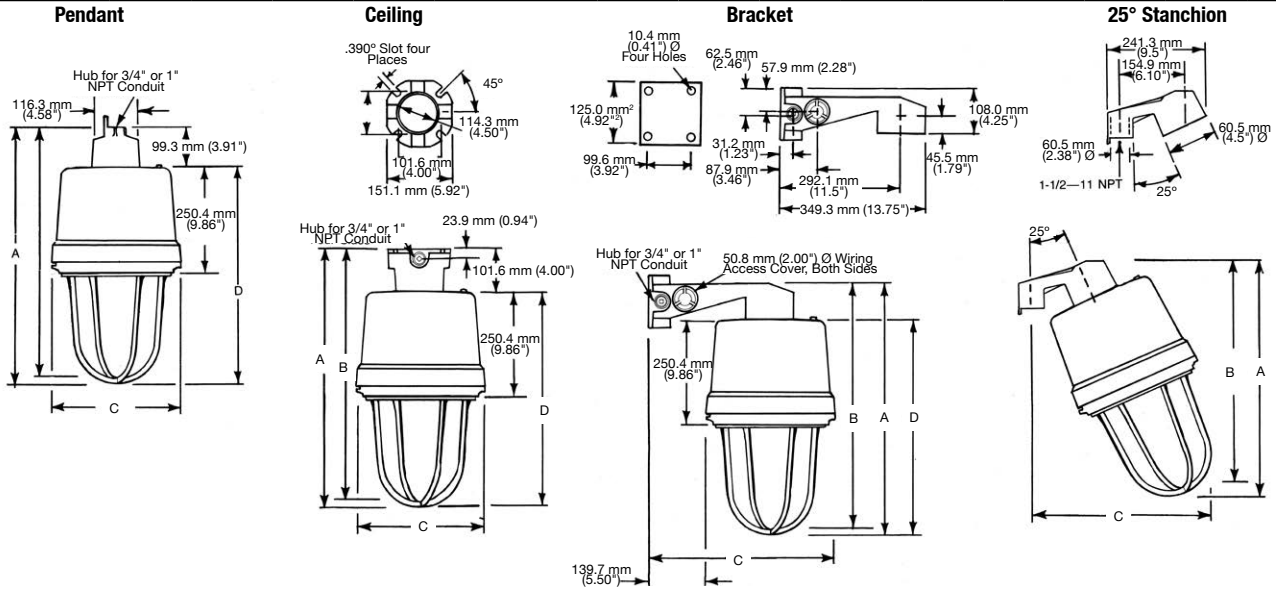

	Pendant				Ceiling				Bracket			25° Stanchion			
	A	B	C	D	A	B	C	D	A	B	C	D	A	B	C
50-250 W ①	546.1 (21.50)	520.7 (20.50)	304.8 (12.00)	447.3 (17.61)	548.9 (21.61)	523.5 (20.61)	304.8 (12.00)	447.3 (17.61)	555.2 (21.86)	529.8 (20.86)	444.5 (17.50)	447.3 (17.61)	495.3 (19.50)	475.0 (18.70)	406.4 (16.00)
250-400 W ②	522.3 (24.50)	596.9 (23.50)	304.8 (12.00)	507.1 (20.36)	618.7 (24.36)	507.1 (20.36)	304.8 (12.00)	507.1 (20.36)	625.1 (24.61)	599.7 (23.61)	444.5 (17.50)	507.1 (20.36)	563.9 (22.20)	538.5 (21.20)	444.5 (17.50)

Fixture and Accessory Weights kg (lb)

Fixture Size	Fixture Weight	Reflector Weight	Guard Weight
50 W through 175 W	14.5 (31.97)	1.4 (3.09)	0.5 (1.10)
250 W PSMH/MH	16.9 (37.26)	1.4 (3.09)	0.5 (1.10)
250 W HPS	18.1 (39.90)	1.4 (3.09)	0.9 (1.98)
320 W, 350 W and 400 W PSMH, 400 W MH	20.4 (44.97)	1.4 (3.09)	0.9 (1.98)

Mounting Hood Weights kgs (lbs)

Pendant	Ceiling	Bracket	Stanchion
0.9 (2)	1.8 (4)	2.7 (6)	0.9 (2)

Reflector Dimensions in Millimeters (Inches)

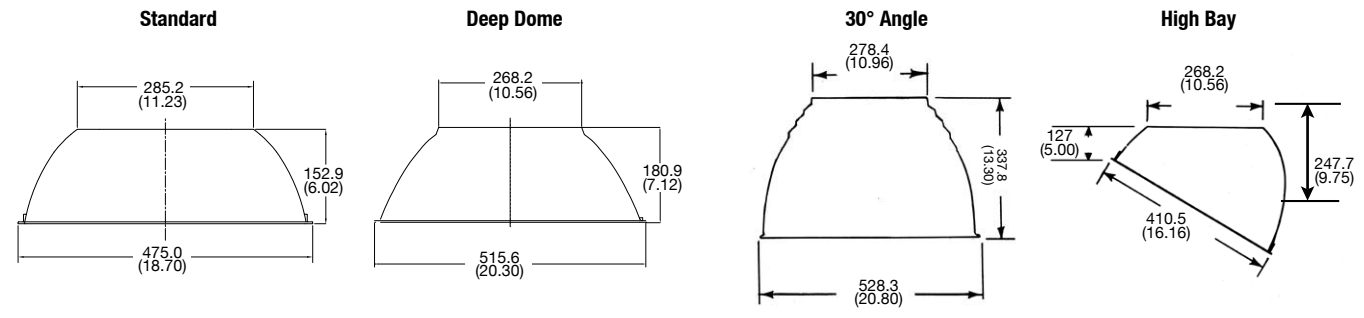

① 50, 70, 100 and 150 W HPS; 175 W PSMH; 175 and 250 W MH.

② 250 and 400 W HPS; 250, 320, 350, and 400 W PSMH; 400 W MH.

Code•Master™ 2 HID Factory Sealed Luminaires

Explosionproof, Dust-Ignitionproof

* Photometric data is based on a 100-watt clear HPS lamp (9,500 lumens). For candlepower values of fixtures with other lamps, use the following multipliers: 50 W HPS – 0.42 (4,000 lumens); 70 W HPS – 0.61 (6,300 lumens); and 150 W HPS – 1.68 (16,000 lumens).

NEC:
 Class I, Division 1 and 2, Groups C, D
 Class II, Division 1 and 2, Groups E, F, G
 Class III
 Marine Type Electric Fixtures
 Outside Type (Salt Water)

CEC:
 Class I, Division 1 and 2, Groups B, C, D
 Class I, Zone 1 and 2; IIB, IIA
 Class II, Division 1, Groups E, F, G
 Class II, Division 2, Groups F, G
 Class III

CEC:
 CSA Type 4X
 Exd IIB, Zone 1

Photometric Data

Total Luminaire Efficiency = 76.4%

CIE Type – Semi-Direct

Plane	Spacing Criteria
0-180	2.66
90-270	2.66
Diagonal	2.84

Zone	Lumens
0-10	29.80
10-20	106.54
20-30	202.92
30-40	318.52
40-50	468.31
50-60	670.49
60-70	866.67
70-80	976.61
80-90	1038.41
90-100	1042.18
100-110	927.00
110-120	551.82
120-130	51.82
130-140	2.51
140-150	0.25
150-160	0.00
160-170	0.00
170-180	0.00

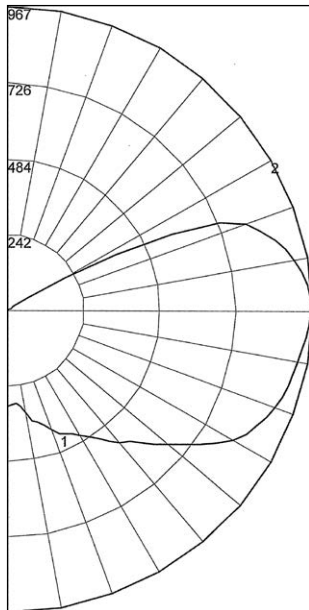

REPORT NUMBER: **CL10G**

Lamps: 100 W High Pressure Sodium with Globe only

Coefficients of Utilization – Zonal Cavity Method

Effective Floor Cavity Reflectance 0.20

% Ceiling Rcc	% Walls	Rw	80				70				50				30				10				0
			70	50	30	10	70	50	30	10	50	30	10	50	30	10	50	30	10	50	30	10	
0			84	84	84	84	79	79	79	79	70	70	70	61	61	61	53	53	53	49			
1			72	66	61	56	66	61	57	52	53	49	46	45	42	40	38	36	34	30			
2			63	54	47	41	58	51	44	39	43	38	34	37	32	29	30	27	24	21			
3			56	46	38	32	52	43	36	30	36	31	26	31	26	22	25	22	18	15			
4			51	40	32	26	47	37	30	24	31	25	21	26	22	18	22	18	14	12			
5			46	35	27	21	42	32	25	20	28	22	17	23	18	14	19	15	12	9			
6			42	31	23	18	39	29	22	17	24	19	14	21	16	12	17	13	10	7			
7			39	28	20	15	36	26	19	14	22	16	12	18	14	10	15	11	8	6			
8			36	25	18	13	33	23	17	12	20	14	10	17	12	9	14	10	7	5			
9			33	23	16	11	31	21	15	11	18	13	9	15	11	8	13	9	6	4			
10			31	21	14	10	29	19	13	9	17	12	8	14	10	7	12	8	6	4			

Zonal Lumen Summary

Zone	Lumens	% Lamp	% Fixture	Zone	Lumens	% Lamp	% Fixture
0-30	339.26	3.6	4.7	90-120	2521.83	26.5	34.8
0-40	657.79	6.9	9.1	90-130	2572.83	27.1	35.5
0-60	1796.59	18.9	24.8	90-150	2575.59	27.1	35.5
0-90	4678.28	49.2	64.5	90-180	2575.59	27.1	35.5
				0-180	7253.87	76.4	100.0

Total Luminaire Efficiency = 71.3%

CIE Type – Direct

Plane	Spacing Criteria
0-180	1.54
90-270	1.54
Diagonal	1.66

Zone	Lumens
0-10	40.00
10-20	331.02
20-30	660.22
30-40	934.51
40-50	1131.33
50-60	1272.76
60-70	1322.68
70-80	826.95
80-90	254.44
90-100	0.00
100-110	0.00
110-120	0.00
120-130	0.00
130-140	0.00
140-150	0.00
150-160	0.00
160-170	0.00
170-180	0.00

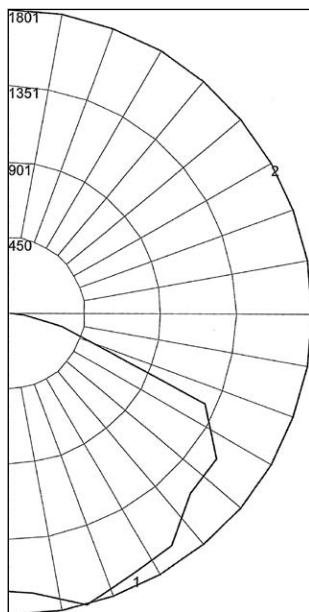

REPORT NUMBER: **CL10ST**

Lamps: 100 W High Pressure Sodium with Standard Dome Reflector

Coefficients of Utilization – Zonal Cavity Method

Effective Floor Cavity Reflectance 0.20

% Ceiling Rcc	% Walls	Rw	80				70				50				30				10				0
			70	50	30	10	70	50	30	10	50	30	10	50	30	10	50	30	10	50	30	10	
0			85	85	85	85	83	83	83	83	79	79	79	76	76	76	73	73	73	71			
1			76	71	68	64	74	70	66	63	67	64	61	64	61	59	61	59	57	56			
2			67	60	54	49	65	59	53	49	56	51	47	54	50	46	51	48	45	43			
3			60	51	44	39	58	50	44	38	48	42	38	46	41	37	44	40	36	34			
4			54	44	37	31	52	43	36	31	41	35	31	40	34	30	38	33	30	28			
5			49	39	31	26	48	38	31	26	36	30	25	35	29	25	33	29	25	23			
6			45	34	27	22	43	33	27	22	32	26	21	31	25	21	30	25	21	19			
7			41	30	23	19	40	30	23	18	29	23	18	28	22	18	27	22	18	16			
8			38	27	21	16	37	27	20	16	26	20	16	25	20	16	24	19	16	14			
9			35	25	18	14	34	24	18	14	24	18	14	23	18	14	22	17	14	12			
10			33	23	17	12	32	22	16	12	22	16	12	21	16	12	20	15	12	11			

Zonal Lumen Summary

Zone	Lumens	% Lamp	% Fixture	Zone	Lumens	% Lamp	% Fixture
0-30	1031.23	10.9	15.2	90-120	0.00	0.0	0.0
0-40	1965.74	20.7	29.0	90-130	0.00	0.0	0.0
0-60	4369.83	46.0	64.5	90-150	0.00	0.0	0.0
0-90	6773.90	71.3	100.0	90-180	0.00	0.0	0.0
				0-180	6773.90	71.3	100.0

Code•Master™ 2 HID Factory Sealed Luminaires

Explosionproof, Dust-Ignitionproof

* Photometric data is based on a 100-watt clear High Pressure Sodium lamp (9,500 lumens). For candlepower values of fixtures with other lamps, use the following multipliers: 50 W HPS – 0.42 (4,000 lumens); 70 W HPS – 0.61 (6,300 lumens); and 150 W HPS – 1.68 (16,000 lumens).

NEC:

Class I, Division 1 and 2, Groups C, D
 Class II, Division 1 and 2, Groups E, F, G
 Class III
 Marine Type Electric Fixtures
 Outside Type (Salt Water)

CEC:

Class I, Division 1 and 2, Groups B, C, D
 Class I, Zone 1 and 2; IIB, IIA
 Class II, Division 1, Groups E, F, G
 Class II, Division 2, Groups F, G
 Class III

CEC:

CSA Type 4X
 Exd IIB, Zone 1

Photometric Data

Total Luminaire Efficiency = 61.9%

CIE Type – Direct

Plane	Spacing Criteria
0-180	1.96
90-270	1.62
Diagonal	1.50

Zone	Lumens
0-10	34.59
10-20	289.50
20-30	587.71
30-40	825.38
40-50	944.04
50-60	952.84
60-70	900.69
70-80	740.88
80-90	607.55
90-100	0.00
100-110	0.00
110-120	0.00
120-130	0.00
130-140	0.00
140-150	0.00
150-160	0.00
160-170	0.00
170-180	0.00

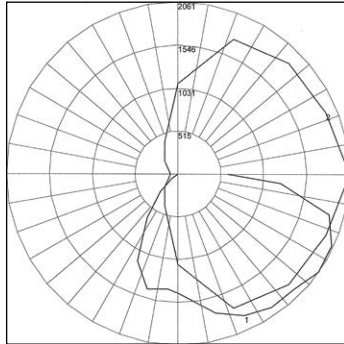

REPORT NUMBER: **CL10AN**

Lamps: 100 W High Pressure Sodium with 30° Angle Dome Reflector

Coefficients of Utilization – Zonal Cavity Method

		Effective Floor Cavity Reflectance 0.20																				
		80				70				50				30				10				0
% Ceiling	Rcc	70	50	30	10	70	50	30	10	50	30	10	50	30	10	50	30	10	50	30	10	0
% Walls	Rw																					
0	0	74	74	74	74	72	72	72	72	69	69	69	66	66	66	63	63	63	63	63	63	62
1	1	64	60	56	53	62	59	55	52	56	53	50	53	51	49	51	49	47	47	45	43	46
2	2	57	51	45	41	55	49	44	40	47	43	39	45	41	38	43	40	37	37	33	30	28
3	3	51	43	37	32	50	42	37	32	40	35	31	38	34	31	37	33	30	28	25	23	23
4	4	47	38	31	26	45	37	31	26	35	30	26	34	29	25	32	28	25	23	20	19	19
5	5	42	33	27	22	41	32	26	22	31	26	21	30	25	21	28	24	21	21	19	18	18
6	6	39	29	23	19	38	29	23	18	28	22	18	26	22	18	25	21	18	18	16	15	16
7	7	36	26	20	16	35	26	20	16	25	20	16	24	19	16	23	19	15	15	14	13	14
8	8	33	24	18	14	32	23	18	14	22	17	14	22	17	14	21	17	13	12	12	11	12
9	9	31	22	16	12	30	21	16	12	20	15	12	20	15	12	19	15	12	11	11	10	11
10	10	29	20	14	11	28	19	14	11	19	14	11	18	14	11	18	13	11	10	10	9	10

Zonal Lumen Summary

Zone	Lumens	% Lamp	% Fixture	Zone	Lumens	% Lamp	% Fixture
0-30	911.80	9.6	15.5	90-120	0.0	0.0	0.0
0-40	1737.18	18.3	29.5	90-130	0.0	0.0	0.0
0-60	3634.06	38.3	61.8	90-150	0.0	0.0	0.0
0-90	5883.18	61.9	100.0	90-180	0.0	0.0	0.0
0-180	5883.18	61.9	100.0				

Total Luminaire Efficiency = 37.8%

CIE Type – Direct

Plane	Spacing Criteria
0-180	1.36
90-270	1.36
Diagonal	1.54

Zone	Lumens
0-10	26.07
10-20	224.04
20-30	437.71
30-40	551.18
40-50	656.83
50-60	743.35
60-70	592.81
70-80	265.53
80-90	94.52
90-100	0.00
100-110	0.00
110-120	0.00
120-130	0.00
130-140	0.00
140-150	0.00
150-160	0.00
160-170	0.00
170-180	0.00

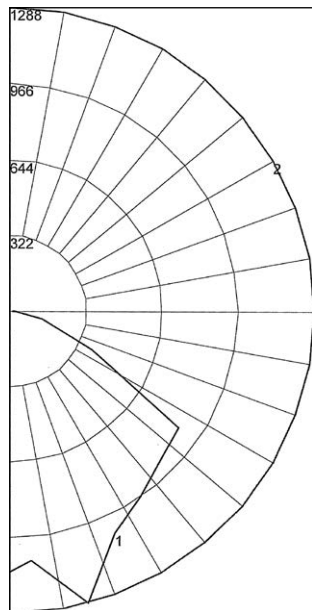

REPORT NUMBER: **CL10DD**

Lamps: 100 W High Pressure Sodium with Deep Dome Reflector

Coefficients of Utilization – Zonal Cavity Method

		Effective Floor Cavity Reflectance 0.20																				
		80				70				50				30				10				0
% Ceiling	Rcc	70	50	30	10	70	50	30	10	50	30	10	50	30	10	50	30	10	50	30	10	0
% Walls	Rw																					
0	0	45	45	45	45	44	44	44	44	42	42	42	40	40	40	39	39	39	38	38	38	38
1	1	41	39	37	35	40	38	36	35	36	35	34	35	34	33	33	32	32	31	31	31	31
2	2	37	33	30	28	36	32	30	28	31	29	27	30	28	26	29	27	26	25	25	25	25
3	3	33	29	25	22	32	28	25	22	27	24	22	26	23	21	25	23	21	20	20	20	20
4	4	30	25	21	18	29	24	21	18	23	20	18	22	20	18	22	19	18	17	17	17	17
5	5	27	22	18	15	26	21	18	15	21	17	15	20	17	15	19	17	15	14	14	14	14
6	6	25	19	16	13	24	19	16	13	18	15	13	18	15	13	17	15	13	12	12	12	12
7	7	23	17	14	11	22	17	14	11	16	13	11	16	13	11	15	13	11	10	10	10	10
8	8	21	16	12	10	21	15	12	10	15	12	10	14	12	10	14	11	10	9	9	9	9
9	9	20	14	11	9	19	14	11	9	13	11	9	13	10	8	13	10	8	8	8	8	8
10	10	18	13	10	8	18	13	10	8	12	10	8	12	9	8	12	9	7	7	7	7	7

Zonal Lumen Summary

Zone	Lumens	% Lamp	% Fixture	Zone	Lumens	% Lamp	% Fixture
0-30	687.82	7.2	19.1	90-120	0.0	0.0	0.0
0-40	1239.00	13.0	34.5	90-130	0.0	0.0	0.0
0-60	2639.18	27.8	73.5	90-150	0.0	0.0	0.0
0-90	3592.04	37.8	100.0	90-180	0.0	0.0	0.0
0-180	3592.04	37.8	100.0				

Code•Master™ 2 HID Factory Sealed Luminaires

Explosionproof, Dust-Ignitionproof

* Photometric data is based on a 400-watt clear Pulse Start Metal Halide lamp (34,000 lumens). For candlepower values of fixtures with other lamps, use the following multipliers: 400 W HPS – 1.13 (50,000 lumens); and 250 W HPS – 0.68 (30,000 lumens).

NEC:
 Class I, Division 1 and 2, Groups C, D
 Class II, Division 1 and 2, Groups E, F, G
 Class III
 Marine Type Electric Fixtures
 Outside Type (Salt Water)

CEC:
 Class I, Division 1 and 2, Groups B, C, D
 Class I, Zone 1 and 2; IIB, IIA
 Class II, Division 1, Groups E, F, G
 Class II, Division 2, Groups F, G
 Class III

CEC:
 CSA Type 4X
 Exd IIB, Zone 1

Photometric Data

Total Luminaire Efficiency = 81.9%

CIE Type – General Diffuse

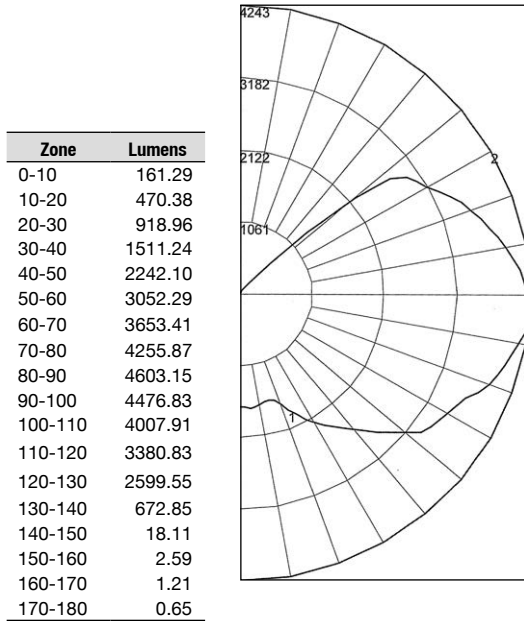

REPORT NUMBER: CP40G

Lamps: 400 W Pulse Start Metal Halide with Globe only

Coefficients of Utilization – Zonal Cavity Method

Effective Floor Cavity Reflectance 0.20

% Ceiling	Rcc	80				70				50			30			10			0
		70	50	30	10	70	50	30	10	50	30	10	50	30	10	50	30	10	0
0	89	89	89	89	83	83	83	83	72	72	72	61	61	61	52	52	52	47	
1	76	70	65	60	70	65	60	56	55	51	48	46	43	40	38	35	33	29	
2	67	59	51	45	62	54	48	42	45	40	36	37	33	30	30	27	24	20	
3	60	50	42	36	55	46	39	33	39	33	28	32	27	23	25	22	19	15	
4	55	43	35	29	50	40	32	27	33	27	23	27	22	19	22	18	15	12	
5	50	38	30	24	45	35	28	22	29	23	19	24	19	15	19	15	12	9	
6	45	34	26	20	41	31	24	18	26	20	16	21	16	13	17	13	10	8	
7	42	30	22	17	38	28	21	16	23	18	13	19	14	11	15	11	9	6	
8	39	27	20	15	35	25	18	14	21	15	12	17	13	9	14	10	7	5	
9	36	25	18	13	33	23	16	12	19	14	10	16	11	8	13	9	6	5	
10	33	22	16	11	31	21	15	10	18	12	9	15	10	7	12	8	6	4	

Zonal Lumen Summary

Zone	Lumens	% Lamp	% Fixture	Zone	Lumens	% Lamp	% Fixture
0-30	1550.63	3.5	4.3	90-120	11865.57	27.0	32.9
0-40	3061.87	7.0	8.5	90-130	14465.12	32.9	40.1
0-60	8356.25	19.0	23.2	90-150	15156.08	34.4	40.1
0-90	20868.68	47.4	57.9	90-180	15160.53	34.5	42.1
				0-180	36029.22	81.9	100.0

Total Luminaire Efficiency = 70.4%

CIE Type – Direct

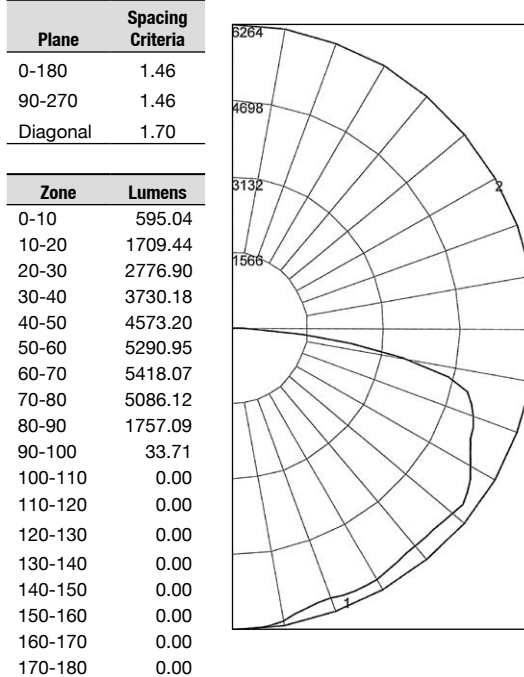

REPORT NUMBER: CP40ST

Lamps: 400 W Pulse Start Metal Halide with Standard Dome Reflector

Coefficients of Utilization – Zonal Cavity Method

Effective Floor Cavity Reflectance 0.20

% Ceiling	Rcc	80				70				50			30			10			0
		70	50	30	10	70	50	30	10	50	30	10	50	30	10	50	30	10	0
0	84	84	84	84	82	82	82	82	78	78	78	75	75	75	72	72	72	70	
1	74	69	65	62	72	68	64	60	64	61	58	62	59	57	59	57	55	53	
2	65	58	52	47	63	57	51	46	54	49	45	51	47	44	49	46	43	41	
3	58	49	42	37	57	48	42	36	46	40	36	44	39	35	42	38	34	32	
4	53	43	35	30	51	42	35	30	40	34	29	38	33	29	36	32	28	26	
5	48	38	30	25	46	37	30	25	35	29	24	34	28	24	32	27	24	22	
6	44	33	26	21	43	33	26	21	31	25	21	30	25	21	29	24	20	19	
7	41	30	23	18	39	29	23	18	28	22	18	27	22	18	26	21	18	16	
8	38	27	21	16	37	27	20	16	26	20	16	25	19	16	24	19	15	14	
9	35	25	18	14	34	24	18	14	23	18	14	23	18	14	22	17	14	12	
10	33	23	17	13	32	22	17	13	22	16	13	21	16	12	20	16	12	11	

Zonal Lumen Summary

Zone	Lumens	% Lamp	% Fixture	Zone	Lumens	% Lamp	% Fixture
0-30	5081.38	11.5	16.4	90-120	33.71	0.1	0.1
0-40	8811.56	20.0	28.5	90-130	33.71	0.1	0.1
0-60	18675.71	42.4	60.3	90-150	33.71	0.1	0.1
0-90	30936.99	70.3	99.9	90-180	33.71	0.1	0.1
				0-180	30970.7	70.4	100.0

Code•Master™ 2 HID Factory Sealed Luminaires

Explosionproof, Dust-Ignitionproof

* Photometric data is based on a 400-watt clear Pulse Start Metal Halide lamp (34,000 lumens). For candlepower values of fixtures with other lamps, use the following multipliers: 400 W HPS – 1.13 (50,000 lumens); and 250 W HPS – 0.68 (30,000 lumens).

NEC:
 Class I, Division 1 and 2, Groups C, D
 Class II, Division 1 and 2, Groups E, F, G
 Class III
 Marine Type Electric Fixtures
 Outside Type (Salt Water)

CEC:
 Class I, Division 1 and 2, Groups B, C, D
 Class I, Zone 1 and 2; IIB, IIA
 Class II, Division 1, Groups E, F, G
 Class II, Division 2, Groups F, G
 Class III

CEC:
 CSA Type 4X
 Exd IIB, Zone 1

Photometric Data

Total Luminaire Efficiency = 62.5%

CIE Type – Direct

Plane	Spacing Criteria
0-180	2.02
90-270	1.48
Diagonal	1.64

Zone	Lumens
0-10	503.08
10-20	1461.14
20-30	2434.06
30-40	3353.43
40-50	3867.50
50-60	3954.40
60-70	3752.38
70-80	3368.71
80-90	2643.39
90-100	1531.50
100-110	421.63
110-120	86.74
120-130	65.68
130-140	20.81
140-150	11.94
150-160	7.93
160-170	4.46
170-180	1.47

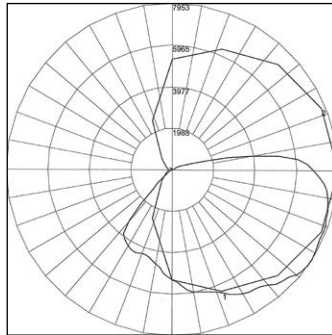

REPORT NUMBER: CP40AN

Lamps: 400 W Pulse Start Metal Halide with 30° Angle Dome Reflector

Coefficients of Utilization – Zonal Cavity Method

Effective Floor Cavity Reflectance 0.20

% Ceiling	Rcc	80				70				50				30				10				0
		70	50	30	10	70	50	30	10	50	30	10	50	30	10	50	30	10				
% Walls	Rw																					
0	0	73	73	73	73	71	71	71	71	67	67	67	63	63	63	59	59	59	58			
1	1	64	60	56	53	62	58	55	52	54	52	49	51	49	47	48	46	44	42			
2	2	57	51	45	41	55	49	44	40	46	42	38	43	40	37	40	38	35	33			
3	3	51	44	38	33	49	42	37	32	39	35	31	37	33	30	35	31	26	27			
4	4	47	38	32	27	45	37	31	26	35	29	25	32	28	25	30	27	24	22			
5	5	43	34	27	23	41	33	27	22	31	25	22	29	24	21	27	23	20	19			
6	6	39	30	24	19	38	29	23	19	27	22	18	26	21	18	24	20	17	16			
7	7	36	27	21	17	35	26	21	17	25	20	16	23	19	16	22	18	15	14			
8	8	34	24	19	15	32	24	18	15	22	18	14	21	17	14	20	16	13	12			
9	9	31	22	17	13	30	22	16	13	21	16	13	20	15	12	19	15	12	11			
10	10	29	20	15	12	28	20	15	12	19	14	11	18	14	11	17	13	11	10			

Zonal Lumen Summary

Zone	Lumens	% Lamp	% Fixture	Zone	Lumens	% Lamp	% Fixture
0-30	4398.28	10.0	16.0	90-120	2039.87	4.6	7.4
0-40	7751.71	17.6	28.2	90-130	2105.55	4.8	7.7
0-60	15573.61	35.4	56.7	90-150	2138.30	4.9	7.7
0-90	25338.08	57.6	92.2	90-180	2152.16	4.9	7.8
				0-180	27490.24	62.5	100.0

Total Luminaire Efficiency = 69.1%

CIE Type – Direct

Plane	Spacing Criteria
0-180	1.48
90-270	1.48
Diagonal	1.62

Zone	Lumens
0-10	676.92
10-20	1962.51
20-30	3199.12
30-40	4281.42
40-50	4889.12
50-60	5408.09
60-70	5456.18
70-80	3822.90
80-90	693.25
90-100	20.14
100-110	0.00
110-120	0.00
120-130	0.00
130-140	0.00
140-150	0.00
150-160	0.00
160-170	0.00
170-180	0.00

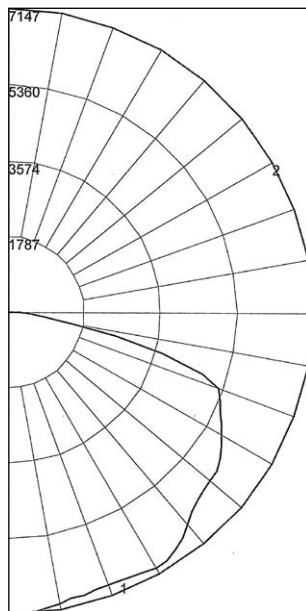

REPORT NUMBER: CP40DD

Lamps: 400 W Pulse Start Metal Halide with Deep Dome Reflector

Coefficients of Utilization – Zonal Cavity Method

Effective Floor Cavity Reflectance 0.20

% Ceiling	Rcc	80				70				50				30				10				0
		70	50	30	10	70	50	30	10	50	30	10	50	30	10	50	30	10				
% Walls	Rw																					
0	0	82	82	82	82	80	80	80	80	77	77	77	73	73	73	70	70	70	69			
1	1	74	70	66	63	72	68	65	62	65	63	60	63	60	58	60	58	57	55			
2	2	66	59	54	49	64	58	53	49	55	51	47	53	49	46	51	48	45	44			
3	3	59	51	44	39	57	50	44	39	48	42	38	46	41	38	44	40	37	35			
4	4	54	44	38	32	52	43	37	32	42	36	32	40	35	31	38	34	31	29			
5	5	49	39	32	27	47	38	32	27	37	31	27	35	30	26	34	29	26	24			
6	6	45	35	28	23	44	34	28	23	33	27	23	32	26	23	30	26	22	21			
7	7	41	31	24	20	40	31	24	20	30	24	20	29	23	20	28	23	19	18			
8	8	38	28	22	18	37	28	22	18	27	21	17	26	21	17	25	21	17	16			
9	9	36	26	20	16	35	25	20	16	25	19	16	24	19	15	23	19	15	14			
10	10	34	24	18	14	33	23	18	14	23	18	14	22	17	14	21	17	14	12			

Zonal Lumen Summary

Zone	Lumens	% Lamp	% Fixture	Zone	Lumens	% Lamp	% Fixture
0-30	5838.56	13.3	19.2	90-120	20.14	0.0	0.1
0-40	10119.98	23.0	33.3	90-130	20.14	0.0	0.1
0-60	20417.19	46.4	67.1	90-150	20.14	0.0	0.1
0-90	30389.51	69.1	99.9	90-180	20.14	0.0	0.1
				0-180	30409.65	69.1	100.0

Code•Master™ 2 HID Factory Sealed Luminaires

Explosionproof, Dust-Ignitionproof

* Photometric data is based on a 400-watt clear Pulse Start Metal Halide lamp (34,000 lumens). For candlepower values of fixtures with other lamps, use the following multipliers: 400 W HPS – 1.13 (50,000 lumens); and 250 W HPS – 0.68 (30,000 lumens).

NEC:
 Class I, Division 1 and 2, Groups C, D
 Class II, Division 1 and 2, Groups E, F, G
 Class III
 Marine Type Electric Fixtures
 Outside Type (Salt Water)

CEC:
 Class I, Division 1 and 2, Groups B, C, D
 Class I, Zone 1 and 2; IIB, IIA
 Class II, Division 1, Groups E, F, G
 Class II, Division 2, Groups F, G
 Class III

CEC:
 CSA Type 4X
 Exd IIB, Zone 1

Photometric Data

Total Luminaire Efficiency = 63.4%

CIE Type – Direct

Plane	Spacing Criteria
0-180	1.40
90-270	1.40
Diagonal	1.52

Zone	Lumens
0-10	1044.42
10-20	3491.70
20-30	5976.88
30-40	6632.58
40-50	7143.25
50-60	2844.46
60-70	634.65
70-80	115.54
80-90	20.82
90-100	1.23
100-110	0.00
110-120	0.00
120-130	0.00
130-140	0.00
140-150	0.00
150-160	0.00
160-170	0.00
170-180	0.00

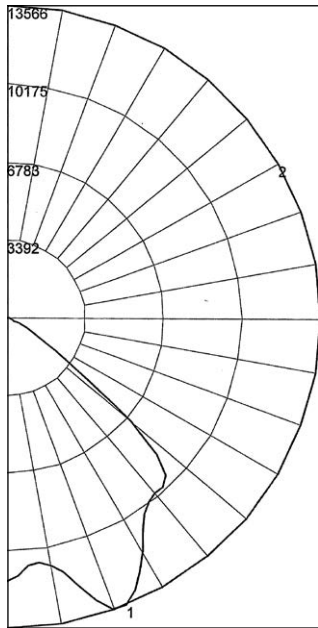

REPORT NUMBER: CP40HB

Lamps: 400 W Pulse Start Metal Halide with High Bay Reflector

Coefficients of Utilization – Zonal Cavity Method

Effective Floor Cavity Reflectance 0.20

% Ceiling % Walls	Rcc Rw	80				70				50				30				10				0			
		70	50	30	10	70	50	30	10	50	30	10	50	30	10	50	30	10	50	30	10	0			
0		76	76	76	76	74	74	74	74	70	70	70	67	67	67	65	65	65	63						
1		71	69	67	65	69	67	65	64	65	63	62	62	61	60	60	59	58	57						
2		66	62	59	56	64	61	58	55	59	56	54	57	55	53	55	53	52	50						
3		61	56	52	48	60	55	51	48	53	50	47	51	49	46	50	48	46	44						
4		57	50	46	42	55	50	45	42	48	44	42	47	44	41	45	43	40	39						
5		53	46	41	37	51	45	40	37	44	40	37	43	39	36	42	38	36	35						
6		49	42	37	33	48	41	36	33	40	36	33	39	35	32	38	35	32	31						
7		46	38	33	30	44	37	33	29	37	32	29	36	32	29	35	31	29	28						
8		42	35	30	27	42	34	30	26	34	29	26	33	29	26	32	29	26	25						
9		40	32	27	24	39	32	27	24	31	27	24	30	26	24	30	26	24	23						
10		37	29	25	22	36	29	25	22	29	24	22	28	24	22	27	24	21	20						

Zonal Lumen Summary

Zone	Lumens	% Lamp	% Fixture	Zone	Lumens	% Lamp	% Fixture
0-30	10513.00	23.9	37.7	90-120	1.23	0.0	0.0
0-40	17145.58	39.0	61.4	90-130	1.23	0.0	0.0
0-60	27133.29	61.7	97.2	90-150	1.23	0.0	0.0
0-90	27904.30	63.4	100.0	90-180	1.23	0.0	0.0
				0-180	27905.53	63.4	100.0

HID/AREA: NEC/CEC EXPLOSIONPROOF



Code•Master™ Jr. HID Factory Sealed Luminaires

Explosionproof, Dust-Ignitionproof

Integrally Ballasted. 50 W, 70 W, 100 W, 150 W HPS; 50 W, 70 W, 100 W, 175 W PSMH. 175 W MH. Medium Base. For Use with Threaded Metal Conduit.

NEC:

Class I, Division 1 and 2, Groups B, C, D
Class II, Division 1 and 2, Groups E, F, G
Class III
Marine type electric fixtures, outside type
(salt water)

CEC:

Class I, Division 1 and 2, Groups B, C, D
Class II, Division 1 and 2, Groups E, F, G
Class III
Type 4X
Exd IIB + H₂

Applications

- For use in chemical and petrochemical plants, such as manufacturers of plastics, paints and thinners; in refineries; and in other areas where ignitable vapors, dust, moisture and corrosive elements may be present.
- Suitable for outdoor saltwater locations and for other wet locations.

Features

- Fixtures operate safely in high ambient temperatures.
- Arrangement of heat-producing components results in efficient heat dissipation for cooler fixture operation.
- Patented “wireless” design. Threading of fixture unit onto mounting hood makes electrical connection. Only wiring required is attaching two wires to connection block in mounting hood.
- Connection block is easily wired: (a) loosen two screws, (b) make wire connections, and (c) re-position connection block.
- Safe, easy servicing without disconnecting any wiring. “Wireless” fixture unit threads off mounting hood for convenient servicing or for immediate replacement with a “stand-by” unit.
- Acme double-lead threads speed installation and fixture removal from mounting hood – only half as many turns are required as for single-lead threads. The threads do not stick or gall, eliminating problems often encountered with single-lead threads during fixture unit removal.
- All threaded joints are flame-tight.
- Integrally ballasted HID lighting fixtures; separate ballasts not required.
- Factory sealed. External seals not required for Groups C and D.
- Fixtures for use in NEC Group B locations furnished complete with UL required sealing fitting. Not required for CEC approval.
- Strategic location of lamp socket, in combination with interior prism design of the glass globe, provides optimum light distribution and control.
- Heat and impact-resistant globes have smooth dust-resistant exterior.
- Superior corrosion resistance, with epoxy powder coat finish.
- Shock-absorbing medium-base socket mounts prolong lamp life.
- Porcelain socket with nickel-plated phosphor bronze screw shell.
Assures long trouble-free operation in high ambient areas.
- Choice of mountings: pendant, ceiling, bracket and stanchion.
- Fiberglass-reinforced polyester reflectors, in standard dome, or 30° angle styles, are ideal in installations where luminaire is subject to exceptionally severe corrosive atmospheres.
- Optional guards protect globes from damage. Secured to fixture with three stainless steel screws.
- Variety of light sources: high pressure sodium, pulse start metal halide and metal halide. HPS is excellent where long lamp life is required. HPS provides high lumens per watt and is less expensive to operate. PSMH and MH are desirable where colors in illuminated areas must be close to natural.
- A wide range of ballasts and voltages are available for both domestic and export applications.
- Ballasts operate at low temperatures – PSMH/MH: -29 °C (-20 °F); HPS: -40 °C (-40 °F).
- 50 W through 150 W high pressure sodium ballasts are high reactance, high power factor type.

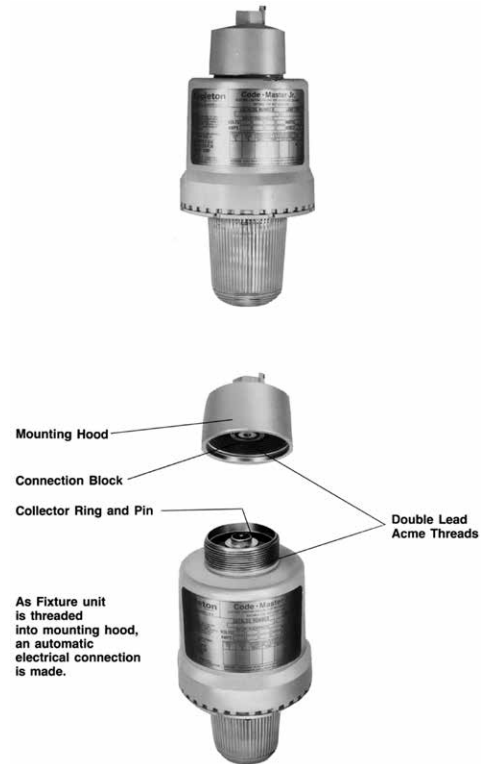

Standard Materials

- Ballast bodies and guards: copperfree (4/10 of 1% max.) aluminum
- Pendant mounting hoods: diecast copperfree (4/10 of 1% max.) aluminum
- Ceiling, bracket and stanchion mounting hoods: sand cast copperfree (4/10 of 1% max.) aluminum
- Reflectors: fiberglass reinforced polyester

Standard Finishes

- Ballast bodies, guards and mounting hoods: epoxy powder coat finish, electrostatically applied for complete, uniform corrosion protection

Options

- Fuses: order fuses for field installation by catalog number, see *Ballast and Fuse Kit Data*.
- “Hot Restrike” – add suffix **-R**. “Smart Starter” – add suffix **-S**. Emergency Options available for 50 W through 150 W HPS only.
- For CEC Exd IIB + H₂ rating, add suffix **-Z**.
- For safety chain, add suffix **-SC**.

NEC/CEC Certifications and Compliances

- UL Standard: UL 1598, UL 844
- UL Listed: E10444
- CSA Standard: C22.2 No. 250, C22.2 No. 137
- CSA Certified: 025428

Code•Master™ Jr. HID Factory Sealed Luminaires

Explosionproof, Dust-Ignitionproof

Integrally Ballasted. 50 W, 70 W, 100 W, 150 W HPS; 50 W, 70 W, 100 W, 175 W PSMH. 175 W MH. Medium Base. For Use with Threaded Metal Conduit.

NEC:
Class I, Division 1 and 2, Groups B, C, D
Class II, Division 1 and 2, Groups E, F, G
Class III
Marine type electric fixtures, outside type
(salt water)

CEC:
Class I, Division 1 and 2, Groups B, C, D
Class II, Division 1 and 2, Groups E, F, G
Class III
Type 4X
Exd IIB + H₂

Lamp Watts	Ballast Type ①	+40 °C (+104 °F) ②		+55 °C (+131 °F) ②		+65 °C (+149 °F) ②		+40 °C (+104 °F) ③	
		Ambient Temp. "T" Numbers	Supply Wire Temp °C (°F)	Ambient Temp. "T" Numbers	Supply Wire Temp °C (°F)	Ambient Temp. "T" Numbers	Supply Wire Temp °C (°F)	Ambient Temp. "T" Numbers	Supply Wire Temp °C (°F)
High Pressure Sodium – Medium Base Lamps									
50	MT, TT	T6	75 (167)	T5	75 (167)	T4A	75 (167)	T4	75 (167)
70	MT, TT, 480 V	T5	75 (167)	T4A	75 (167)	T4A	75 (167)	T4	90 (194)
100	MT, TT, 480 V	T4A	75 (167)	T4	90 (194)	—	—	T3B	90 (194)
150	MT, TT, 480 V	T3C	75 (167)	—	—	—	—	—	—
Pulse Start Metal Halide – Medium Base Lamps									
50	MT, TT	T6	75 (167)	T5	75 (167)	T4A	90 (194)	T3C	90 (194)
70	MT, TT, 480 V	T5	75 (167)	T4A	75 (167)	T4A	90 (194)	T3C	90 (194)
100	MT, TT, 480 V	T4A	90 (194)	T4A	90 (194)	—	—	—	—
175	MT, TT, 480 V	T3B	90 (194)	—	—	—	—	—	—
Metal Halide – Medium Base Lamps									
175	MT, TT, 480 V	T3B	85 (185)	—	—	—	—	—	—

"T" Numbers Represent the Maximum Surface Temperature for Class I, Division 1 Locations and Maximum Surface Temperature Under Dust Blanket for Class II, Division 1 Locations.

"T" Number	T1	350	325	T2	T2A	T2B	T2C	T2D	T3	T3A	T3B	T3C	T4	T4A	T5	T6
Temp. Range (°C)	351-450	326-350	301-325	281-300	261-280	231-260	216-230	201-215	181-200	166-180	161-165	136-160	121-135	101-120	86-100	85
Temp. Range (°F)	664-842	619-662	574-617	538-572	502-536	448-500	421-446	394-419	358-392	331-356	322-329	277-320	250-275	214-248	187-212	185

Fixture and Accessory Weights kg (lb)

Fixture Size	Fixture Weight	Reflector Weight	Guard Weight
35 W thru 175 W	12.70-14.51 (28-32)	1.36 (3)	0.45 (1)

Mounting Hood Weights kgs (lbs)

Pendant	Ceiling	Bracket	Stanchion
0.91 (2)	1.81 (4)	2.72 (6)	0.91 (2)

NOTE: The maximum operating temperature of the fixture must not exceed the ignition temperature of the gas, vapor or dust to be encountered per the National Electrical Code and the Canadian Electrical Code.

① MT is Multi-Tap for 120/208/240/277 V, TT is Tri-Tap for 120/277/347 V.

② Class I, Division 1 Locations.

③ Class II, Division 1 Locations.

Code•Master™ Jr. HID Factory Sealed Luminaires

Explosionproof, Dust-Ignitionproof

Integrally Ballasted. 50 W, 70 W, 100 W, 150 W HPS; 50 W, 70 W, 100 W, 175 W PSMH. 175 W MH. Medium Base. For Use with Threaded Metal Conduit.

NEC:

Class I, Division 1 and 2, Groups B, C, D
 Class II, Division 1 and 2, Groups E, F, G
 Class III
 Marine type electric fixtures, outside type
 (salt water)

Type Mounting	Lamp Watts	ANSI Lamp Type ⑤		Hub Size (Inches)	Catalog Number ②	
		HPS	PSMH		HPS ①	PSMH
Pendant - One Hub, Rigid or Flexible Mounting						
	50	S68	M110	3/4	CJLPB5075 ③	CJHPB5075 ③
	70	S62	M98	3/4	CJLPB7075 ④	CJHPB7075 ④
	100	S54	M90	3/4	CJLPB1075 ④	CJHPB1075 ④
	150	S55	—	3/4	CJLPB1575 ④	—
	175	—	M152	3/4	—	CJPPB1775 ④

25° Stanchion - One Hub						
	50	S68	M110	1-1/2	CJLSB50150 ③	CJHSB50150 ③
	70	S62	M98	1-1/2	CJLSB70150 ④	CJHSB70150 ④
	100	S54	M90	1-1/2	CJLSB10150 ④	CJHSB10150 ④
	150	S55	—	1-1/2	CJLSB15150 ④	—
	175	—	M152	1-1/2	—	CJPSB17150 ④

Mounting Hoods				
Type Mounting		Hub Size (Inches)	Catalog Number	
	Pendant	One Hub	3/4	CAP-75B
	25° Stanchion	One Hub	1-1/2	CAS-150B

① Add suffix **-R** for "Hot Restrike" and **-S** for "Smart Starter" options.
 ② To order fixture with guard, add suffix **-G** (before adding voltage suffix).
 ③ Add voltage **-MT** for 120/208/240/277 V. For 480 V, contact your sales representative.
 ④ Add voltage suffix **-MT** for 120/208/240/277 V, or **-48** for 480 V. Contact your sales representative for available 50 Hz ballasts.
 ⑤ Refer to lamp manufacturer's data regarding lamp burning position restrictions.

Code•Master™ Jr. HID Factory Sealed Luminaires

Explosionproof, Dust-Ignitionproof

Integrally Ballasted. 50 W, 70 W, 100 W, 150 W HPS; 50 W, 70 W, 100 W, 175 W PSMH. 175 W MH. Medium Base. For Use with Threaded Metal Conduit.

NEC:
 Class I, Division 1 and 2, Groups C, D
 Class II, Division 1 and 2, Groups E, F, G
 Class III
 Marine type electric fixtures, outside type
 (salt water)

CEC:
 Class I, Division 1 and 2, Groups B♦, C, D
 Class II, Division 1 and 2, Groups E, F, G
 Class III
 Type 4X
 Exd IIB + H₂

HID/AREA: NEC/CEC EXPLOSIONPROOF



Lamp Watts	ANSI Lamp Type ⑥		Hub Size ⑦ (Inches)	Catalog Number ②		
	HPS	PSMH/MH		HPS ①	PSMH	MH ⑧
Pendant — One Hub, Rigid or Flexible Mounting						
50	S68	M110	3/4	CJLP5075MT ③	CJHP5075MT ③	—
			1	CJLP5075TTCN ⑨ ③	CJHP5075TTCN ⑨ ③	—
70	S62	M98	3/4	CJLP5010MT ③	CJHP5010MT ③	—
			1	CJLP5010TTCN ⑨ ③	CJHP5010TTCN ⑨ ③	—
100	S54	M90	3/4	CJLP7075MT ④	CJHP7075MT ④	—
			1	CJLP7075TTCN ⑨ ⑤	CJHP7075TTCN ⑨ ⑤	—
150	S55	—	3/4	CJLP7010MT ④	CJHP7010MT ④	—
			1	CJLP7010TTCN ⑨ ⑤	CJHP7010TTCN ⑨ ⑤	—
175	—	M152	3/4	CJLP1075MT ④	CJHP1075MT ④	—
			1	CJLP1075TTCN ⑨ ⑤	CJHP1075TTCN ⑨ ⑤	—
175	—	M152	3/4	CJLP1010MT ④	CJHP1010MT ④	—
			1	CJLP1010TTCN ⑨ ④	CJHP1010TTCN ⑨ ⑤	—
175	—	M152	3/4	CJLP1575MT ④	—	—
			1	CJLP1575TTCN ⑨ ⑤	—	—
175	—	M152	3/4	CJLP1510MT ④	—	—
			1	CJLP1510TTCN ⑨ ④	—	—
175	—	M152	3/4	—	CJPP1775MT ④	CJHP1775MTCN ⑨ ④
			1	—	CJPP1775TTCN ⑨ ⑤	CJHP1775TTCN ⑨ ⑤
175	—	M152	3/4	—	CJPP1710MT ④	CJHP1710MTCN ⑨ ④
			1	—	CJPP1710TTCN ⑨ ⑤	CJHP1710TTCN ⑨ ⑤

Appleton®



Ceiling — Four Hubs, Three Close-Up Plugs						
50	S68	M110	3/4	CJLC5075MT ③	CJHC5075MT ③	—
			1	CJLC5075TTCN ⑨ ③	CJHC5075TTCN ⑨ ③	—
70	S62	M98	3/4	CJLC5010MT ③	CJHC5010MT ③	—
			1	CJLC5010TTCN ⑨ ③	CJHC5010TTCN ⑨ ③	—
100	S54	M90	3/4	CJLC7075MT ④	CJHC7075MT ④	—
			1	CJLC7075TTCN ⑨ ⑤	CJHC7075TTCN ⑨ ⑤	—
150	S55	—	3/4	CJLC7010MT ④	CJHC7010MT ④	—
			1	CJLC7010TTCN ⑨ ⑤	CJHC7010TTCN ⑨ ⑤	—
175	—	M152	3/4	CJLC1075MT ④	CJHC1075MT ④	—
			1	CJLC1075TTCN ⑨ ⑤	CJHC1075TTCN ⑨ ⑤	—
175	—	M152	3/4	CJLC1010MT ④	CJHC1010MT ④	—
			1	CJLC1010TTCN ⑨ ⑤	CJHC1010TTCN ⑨ ⑤	—
175	—	M152	3/4	CJLC1575MT ④	—	—
			1	CJLC1575TTCN ⑨ ⑤	—	—
175	—	M152	3/4	CJLC1510MT ④	—	—
			1	CJLC1510TTCN ⑨ ⑤	—	—
175	—	M152	3/4	—	CJPC1775MT ④	CJHC1775MTCN ⑨ ④
			1	—	CJPC1775TTCN ⑨ ⑤	CJHC1775TTCN ⑨ ⑤
175	—	M152	3/4	—	CJPC1710MT ④	CJHC1710MTCN ⑨ ④
			1	—	CJPC1710TTCN ⑨ ⑤	CJHC1710TTCN ⑨ ⑤

- ① Add suffix **-R** for "Hot Restrike" and **-S** for "Smart Starter" options.
- ② To order fixture with guard, add suffix **-G** before adding voltage suffix.
- ③ For 480 V, contact your sales representative.
- ④ Change voltage suffix **-MT** to **-48** for 480 V.
- ⑤ Change voltage suffix **-TT** (120/277/347 V) to **-MT** for 120/208/240/277 V, **-C2** for 208 V, **-C3** for 240 V, **-C6** for 480 V, or **-C7** for 600 V. These voltage suffixes have CSA Certification only.
- ⑥ Refer to lamp manufacturer's data regarding lamp burning position restrictions.
- ⑦ Fixtures with 1" hubs listed for Class I, Group D, and Class II, Groups E, F, G only.
- ⑧ Mercury vapor and metal halide luminaires are not available for purchase within the United States. Please check with your countries governing legislation regarding allowable lamp types before ordering.
- ⑨ Catalog numbers with **-CN** suffix have CSA Certification only.

♦ Shaded area indicates items suitable for Class I, Division 1, Group B.

Code•Master™ Jr. HID Factory Sealed Luminaires

Explosionproof, Dust-Ignitionproof

Integrally Ballasted. 50 W, 70 W, 100 W, 150 W HPS; 50 W, 70 W, 100 W, 175 W PSMH. 175 W MH. Medium Base. For Use with Threaded Metal Conduit.

NEC:

Class I, Division 1 and 2, Groups C, D
 Class II, Division 1 and 2, Groups E, F, G
 Class III
 Marine type electric fixtures, outside type
 (salt water)

CEC:

Class I, Division 1 and 2, Groups B♦, C, D
 Class II, Division 1 and 2, Groups E, F, G
 Class III
 Type 4X
 Exd IIB + H₂

Lamp Watts	ANSI Lamp Type ⑥		Hub Size ⑦ (Inches)	Catalog Number ②		
	HPS	PSMH/MH		HPS ①	PSMH	MH ⑨
Bracket – Four Hubs, Three Close-Up Plugs						
50	S68	M110	3/4	CJLB5075MT ③	CJHB5075MT ③	—
				CJLB5075TTCN ⑩③	CJHB5075TTCN ⑩③	—
			1	CJLB5010MT ③	CJHB5010MT ③	—
				CJLB5010TTCN ⑩③	CJHB5010TTCN ⑩③	—
70	S62	M98	3/4	CJLB7075MT ④	CJHB7075MT ④	—
				CJLB7075TTCN ⑩⑤	CJHB7075TTCN ⑩⑤	—
			1	CJLB7010MT ④	CJHB7010MT ④	—
				CJLB7010TTCN ⑩⑤	CJHB7010TTCN ⑩⑤	—
100	S54	M90	3/4	CJLB1075MT ④	CJHB1075MT ④	—
				CJLB1075TTCN ⑩⑤	CJHB1075TTCN ⑩⑤	—
			1	CJLB1010MT ④	CJHB1010MT ④	—
				CJLB1010TTCN ⑩⑤	CJHB1010TTCN ⑩⑤	—
150	S55	—	3/4	CJLB1575MT ④	—	—
				CJLB1575TTCN ⑩⑤	—	—
			1	CJLB1510MT ④	—	—
				CJLB1510TTCN ⑩⑤	—	—
175	—	M152	3/4	—	CJPB1775MT ④	CJHB1775MTCN ⑩④
				—	CJPB1775TTCN ⑩⑤	CJHB1775TTCN ⑩⑤
			1	—	CJPB1710MT ④	CJHB1710MTCN ⑩④
				—	CJPB1710TTCN ⑩⑤	CJHB1710TTCN ⑩⑤
25° Stanchion – One Hub						
50	S68	M110	1-1/4 or 1-1/2 ⑧	CJLS50150MT ③	CJHS50150MT ③	—
				CJLS50150TTCN ⑩③	CJHS50150TTCN ⑩③	—
70	S62	M98	1-1/4 or 1-1/2 ⑧	CJLS70150MT ④	CJHS70150MT ③	—
				CJLS70150TTCN ⑩④	CJHS70150TTCN ⑩③	—
100	S54	M90	1-1/4 or 1-1/2 ⑧	CJLS10150MT ④	CJHS10150MT ③	—
				CJLS10150TTCN ⑩④	CJHS10150TTCN ⑩③	—
150	S55	—	1-1/4 or 1-1/2 ⑧	CJLS15150MT ④	—	—
				CJLS15150TTCN ⑩④	—	—
175	—	M152	1-1/4 or 1-1/2 ⑧	—	CJPS17150MT	CJHS17150MTCN ⑩
				—	CJPS17150TTCN ⑩	CJHS17150TTCN ⑩



① Add suffix **-R** for "Hot Restrike" and **-S** for "Smart Starter" options.
 ② To order fixture with guard, add suffix **-G** before adding voltage suffix.
 ③ For 480 V, contact your sales representative.
 ④ Change voltage suffix **-MT** to **-48** for 480 V.
 ⑤ Change voltage suffix **-TT** (120/277/347 V) to **-MT** for 120/208/240/277 V, **-C2** for 208 V, **-C3** for 240 V, **-C6** for 480 V, or **-C7** for 600 V. These voltage suffixes have CSA Certification only.
 ⑥ Refer to lamp manufacturer's data regarding lamp burning position restrictions.
 ⑦ Fixtures with 1" hubs listed for Class I, Group D, and Class II, Groups E, F, G only.
 ⑧ 1-1/2" tapped hub furnished with 1-1/2" to 1-1/4" reducer.
 ⑨ Mercury vapor and metal halide luminaires are not available for purchase within the United States. Please check with your countries governing legislation regarding allowable lamp types before ordering.
 ⑩ Catalog numbers with **-CN** suffix have CSA Certification only.
 ♦ Shaded area indicates items suitable for Class I, Division 1, Group B.

HID/AREA: NEC/CEC EXPLOSIONPROOF



Code•Master™ Jr. HID Factory Sealed Luminaires





Explosionproof, Dust-Ignitionproof

Integrally Ballasted. 50 W, 70 W, 100 W, 150 W HPS; 50 W, 70 W, 100 W, 175 W PSMH. 175 W MH. Medium Base. For Use with Threaded Metal Conduit.

NEC:
Class I, Division 1 and 2, Groups B♦, C, D
Class II, Division 1 and 2, Groups E, F, G
Class III
Marine type electric fixtures, outside type
(salt water)

CEC:
Class I, Division 1 and 2, Groups B♦, C, D
Class II, Division 1 and 2, Groups E, F, G
Class III
Type 4X
Exd IIB + H₂

Mounting Hoods

	Hub Size (Inches)	Catalog Number
Pendant — One Hub		
	3/4	CAP-75
	1 ②	CAP-100
Ceiling — Four Hubs, Three Close-Up Plugs		
	3/4	CAC-75
	1 ②	CAC-100
Bracket — Four Hubs, Three Close-Up Plugs		
	3/4	CALB-75
	1 ②	CALB-100
25° Stanchion — One Hub		
	1-1/4 or 1-1/2 ①	CAS-150

Mounting Adapter with Connection Block



Permits use of existing A-51 mounting hoods (AAC Ceiling or AALB Bracket) with the new Code•Master 2 Fixture Unit. After removing existing fixture unit and adapter, screw in the new CMAD-1 Adapter. Then thread new fixture unit into the CMAD-1.

CMAD-1

Fixture Units

Ballast body with globe. Indicate voltage desired by adding voltage suffix to fixture unit catalog number listed below.

Type	Lamp Watts	Fixture Unit Number	Add Voltage Suffixes		
			120/208/240/277	120/277/347 ④	480 V
High Pressure Sodium ③ High Power Factor (Min. P.F. 90%)	50	CJB50L-	MT	TTCN	—
	70	CJB70L-	MT	TTCN	48
	100	CJB100L-	MT	TTCN	48
	150	CJB150L-	MT	TTCN	48
Pulse Start Metal Halide Constant Wattage (Min. P.F. 90%)	50	CJB50H-	MT	TTCN	—
	70	CJB70H-	MT	TTCN	48
	100	CJB100H-	MT	TTCN	48
	175	CJB175P-	MT	TTCN	48
Metal Halide Constant Wattage (Min. P.F. 90%)	175	CJB175H-	MT	TT	C6

① 1-1/2" Tapped hub furnished with 1-1/2" to 1-1/4" reducer.

② Mounting Hoods with 1" hub listed for Class I, Group D; Class II, Groups E,F,G; and Class III only.

③ Add suffix **-R** for "Hot Restrike" and **-S** for "Smart Starter" options.

④ Change voltage suffix **-TTCN** to **-MTCN** for 120/208/240/277 V, **-C2** for 208 V, **-C3** for 240 V, **-C6** for 480 V, or **-C7** for 600 V. These voltage suffixes have CSA Certification only.

⑤ Mercury vapor and metal halide luminaires are not available for purchase within the United States. Please check with your countries governing legislation regarding allowable lamp types before ordering.

◆ Shaded area indicates items suitable for Class I, Division 1, Group B.

HID/AREA: NEC/CEC EXPLOSIONPROOF

Appleton®

Code•Master™ Jr. HID Factory Sealed Luminaires

Explosionproof, Dust-Ignitionproof







Integrally Ballasted. 50 W, 70 W, 100 W, 150 W HPS; 50 W, 70 W, 100 W, 175 W PSMH. 175 W MH. Medium Base. For Use with Threaded Metal Conduit.

NEC:

Class I, Division 1 and 2, Groups B, C, D
 Class II, Division 1 and 2, Groups E, F, G
 Class III
 Marine type electric fixtures, outside type
 (salt water)

CEC:

Class I, Division 1 and 2, Groups B, C, D
 Class II, Division 1 and 2, Groups E, F, G
 Class III
 Type 4X
 Exd IIB + H₂

	Description	Catalog Number
<p>Polyester Reflectors</p>  <p>Standard Dome 30° Angle</p>	<p>Standard Dome 30° Angle</p>	<p>KR2-ST KR2-AN</p>
<p>Three-Way Exit Sign</p> 	<p>Epoxy enameled steel — 6”-high red lettering Mounts to Code•Master Jr. fixture units in place of guard.</p>	<p>CJEXRN</p>
<p>Single Sided Exit Sign</p> 	<p>Epoxy enameled steel — 6”-high red lettering Mounts to Code•Master Jr. fixture units in place of guard.</p> <p>*Contact your sales representative regarding hazardous location suitability.</p>	<p>AEXR-15R</p>
<p>Prismatic Glass Globe and Ring Assembly — 50 W through 175 W</p> 		<p>CJGL-175</p>
<p>Aluminum Guards — 50 W through 175 W</p> 		<p>CJGU-15</p>
<p>Replacement Sockets — 50 W through 175 W</p> 	<p>Medium base sockets</p>	<p>CJMS-175</p>
<p>Connection Block — 50 W through 175 W</p> 	<p>For all Code•Master fixtures</p>	<p>VPT-7</p>
<p>HPS Hot Restrike</p> <p>Restrikes HPS lamp immediately when power is restored after a momentary power interruption. Optional for fixture watts of 50, 70, 100 or 150 (HPS only)</p>		<p>Add suffix -R</p>
<p>Smart Starter</p> <p>Smart Starter is for HPS fixtures only. Incorporates a 1-1/2-minute timer and performs as a conventional starter to normally start lamp. Removes itself from circuit if lamp burns out or is removed from socket. Eliminates starter failures caused by prolonged operation with cycling or failing lamps and simplifies finding their location which reduces maintenance and repair costs. Optional for all HPS and PSMH fixtures.</p>		<p>Add suffix -S</p>

HID/AREA: NEC/CEC EXPLOSIONPROOF



Code•Master™ Jr. HID Factory Sealed Luminaires

Explosionproof, Dust-Ignitionproof

Integrally Ballasted. 50 W, 70 W, 100 W, 150 W HPS; 50 W, 70 W, 100 W, 175 W PSMH. 175 W MH. Medium Base. For Use with Threaded Metal Conduit.

NEC:
 Class I, Division 1 and 2, Groups B, C, D
 Class II, Division 1 and 2, Groups E, F, G
 Class III
 Marine type electric fixtures, outside type
 (salt water)

CEC:
 Class I, Division 1 and 2, Groups B, C, D
 Class II, Division 1 and 2, Groups E, F, G
 Class III
 Type 4X
 Exd IIB + H₂

HID/AREA: NEC/CEC EXPLOSIONPROOF

Appleton®

Lamp Watts	Volts	Ballast Amps				Fuse Quantity Required	Fuse Kit Catalog Number		
		High Pressure Sodium HX–H.P.F. ①		Pulse Start Metal Halide HX–H.P.F. ① — Super CWA ②			HPS	PSMH	MH ④
		Start	Operating	Start	Operating				
50	120	0.58	0.58	0.87	0.60	1	CF-5	CF-3	—
	208	0.35	0.33	0.51	0.40	2	CF-3	CF-3	—
	240	0.31	0.29	0.47	0.35	2	CF-3	CF-2	—
	277	0.25	0.25	0.32	0.32	1	CF-2	CF-2	—
	347 ③	—	—	—	—	—	—	—	—
	480	—	—	—	—	—	—	—	—
70	120	0.90	0.82	0.80	0.85	1	CF-5	CF-5	—
	208	0.50	0.48	0.50	0.52	2	CF-3	CF-3	—
	240	0.44	0.41	0.43	0.44	2	CF-3	CF-3	—
	277	0.35	0.36	0.39	0.39	1	CF-2	CF-2	—
	347 ③	0.30	0.30	0.20	0.28	1	CF-2	CF-2	—
	480	0.21	0.21	0.26	0.23	2	CF-2	CF-2	—
100	120	1.30	1.15	1.20	1.15	1	CF-8	CF-8	—
	208	0.76	0.67	0.70	0.70	2	CF-5	CF-5	—
	240	0.66	0.58	0.61	0.58	2	CF-5	CF-3	—
	277	0.60	0.50	0.55	0.50	1	CF-3	CF-3	—
	347 ③	0.45	0.30	0.40	0.40	1	CF-2	CF-2	—
	480	0.33	0.31	0.30	0.35	2	CF-3	CF-2	—
150	120	2.00	1.66	—	—	1	CF-10	—	—
	208	1.16	0.96	—	—	2	CF-5	—	—
	240	1.00	0.83	0.85	0.80	2	CF-5	CF-5	—
	277	1.00	0.83	—	—	1	CF-5	—	—
	347 ③	0.52	0.56	0.55	0.65	1	CF-3	—	—
	480	0.88	0.75	—	—	2	CF-5	—	—
175	120	1.30	1.80	0.90	1.78	1	—	CF-5	CF-5
	208	0.75	1.04	0.50	1.08	2	—	CF-3	CF-3
	240	0.65	0.90	0.35	0.89	2	—	CF-3	CF-3
	277	0.55	0.80	0.30	0.76	1	—	CF-2	CF-2
	347 ③	0.27	0.65	0.25	0.65	1	—	CF-2	CF-2
	480	0.35	0.45	0.25	0.50	2	—	CF-2	CF-2

Fuse Kit includes fuse, fuse holder and necessary hardware for field installation. Mounts easily in ballast body with one screw. Order one fuse for 120 V and 277 V, and 2 fuses for 208, 240 and 480 V. CF-2 = 2 Amp; CF-3 = 3 Amp; CF-5 = 5 Amp; CF-8 = 8 Amp; CF-10 = 10 Amp

① 35 W through 150 W HPS and 50 W through 100 W PSMH have H.P.F. High Reactance ballasts.

② 175 W PSMH 480 volts has CWA ballast. Multi-tap has Super CWA ballast.

③ 347 V lamp has CSA Certification only.

④ Mercury vapor and metal halide luminaires are not available for purchase within the United States. Please check with your countries governing legislation regarding allowable lamp types before ordering.

Code•Master™ Jr. HID Factory Sealed Luminaires

Explosionproof, Dust-Ignitionproof

Integrally Ballasted. 50 W, 70 W, 100 W, 150 W HPS; 50 W, 70 W, 100 W, 175 W PSMH. 175 W MH. Medium Base. For Use with Threaded Metal Conduit.

NEC:

Class I, Division 1 and 2, Groups B, C, D
 Class II, Division 1 and 2, Groups E, F, G
 Class III
 Marine type electric fixtures, outside type
 (salt water)

CEC:

Class I, Division 1 and 2, Groups B, C, D
 Class II, Division 1 and 2, Groups E, F, G
 Class III
 Type 4X
 Exd IIB + H₂

Dimensions in Millimeters (Inches)

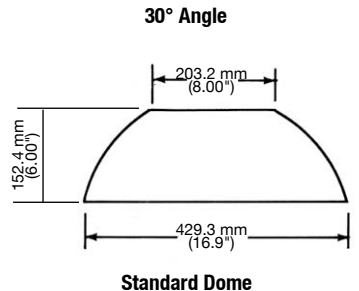
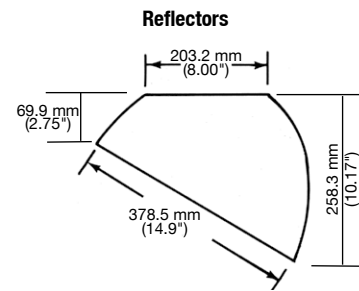
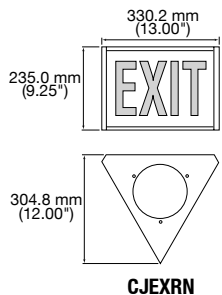
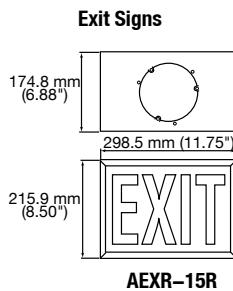
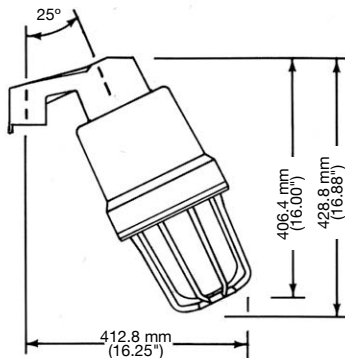
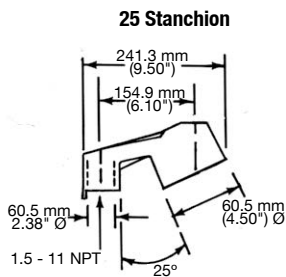
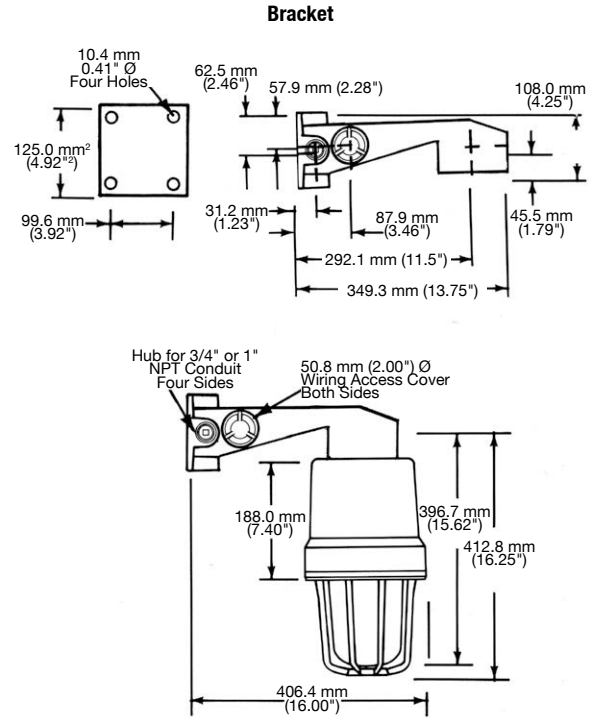
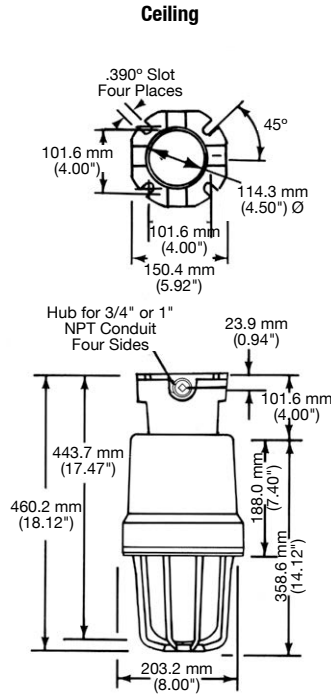
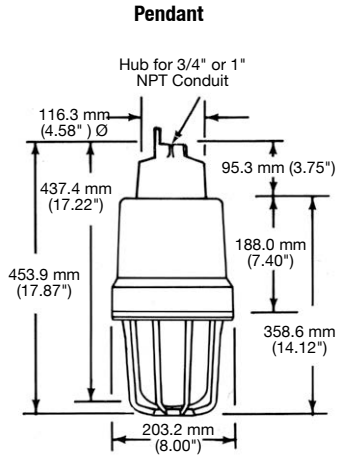

HID/AREA: NEC/CEC EXPLOSIONPROOF



Code•Master™ Jr. HID Factory Sealed Luminaires

Explosionproof, Dust-Ignitionproof

* Photometric data is based on a fixture with a 150-watt clear High Pressure Sodium lamp (16,000 lumen), without guard. For candlepower values of fixtures with other HPS lamps, use the following multipliers: for a 100 W (9,500 lumen) HPS lamp – 0.594; for a 70 W (6,400 lumen) HPS lamp – 0.394; for a 70 W (5800 lumen) HPS lamp – 0.363; for a 50 W (4,000 lumen) HPS lamp – 0.25; for a 35 W (2,250 lumen) HPS lamp – 0.141. For candlepower values of fixture with guard, multiply by 0.95.

NEC:
 Class I, Division 1 and 2, Groups B, C, D
 Class II, Division 1 and 2, Groups E, F, G
 Class III
 Marine type electric fixtures, outside type
 (salt water)

CEC:
 Class I, Division 1 and 2, Groups B, C, D
 Class II, Division 1 and 2, Groups E, F, G
 Class III
 Type 4X
 Exd IIB + H₂

HPS Photometric Data

Zone	Lumens	Total Luminaire Efficiency = 77.5%
0-10	32.97	CIE Type – General Diffuse
10-20	119.16	
20-30	313.87	
30-40	349.57	
40-50	804.55	
50-60	1193.29	
60-70	1327.33	
70-80	1576.23	
80-90	1672.01	
90-100	1647.69	
100-110	1507.22	
110-120	1221.25	
120-130	607.81	
130-140	27.17	
140-150	1.62	
150-160	0.35	
160-170	0.07	
170-180	0.02	

Zonal Lumen Summary			
Zone	Lumens	% Lamp	% Fixture
0-30	465.99	2.9	3.8
0-40	815.56	5.1	6.6
0-60	2813.41	17.6	22.7
0-90	7388.98	46.2	59.6
90-120	4376.17	27.4	35.3
90-130	4983.97	31.1	40.2
90-150	5012.76	31.3	40.2
90-180	5013.20	31.3	40.4
180-0	12402.18	77.5	100.0

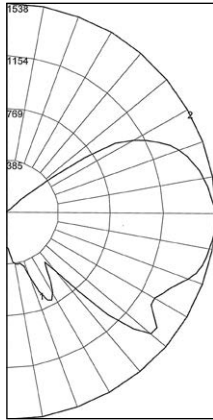

REPORT NUMBER: **CJL15G**

Lamps: 150 W High Pressure Sodium lamp with Globe only *

Coefficients of Utilization – Zonal Cavity Method

Effective Floor Cavity Reflectance 0.20

% Ceiling	Rcc	80				70				50				30				10				0
		70	50	30	10	70	50	30	10	50	30	10	50	30	10	50	30	10	0			
0	85	85	85	85	79	79	79	79	69	69	69	59	59	59	50	50	50	46				
1	72	66	61	57	67	61	57	53	52	49	45	44	41	38	36	34	32	28				
2	64	55	48	42	58	51	44	39	43	38	33	35	31	28	29	26	23	19				
3	57	47	39	33	52	43	36	30	36	30	26	30	25	21	24	20	17	14				
4	51	40	32	26	47	37	30	24	31	25	21	25	21	17	20	16	13	10				
5	46	35	27	21	42	32	25	20	27	21	17	22	17	14	18	14	11	8				
6	42	31	23	18	39	29	22	17	24	18	14	20	15	11	16	12	9	6				
7	39	28	20	15	36	26	19	14	21	16	12	18	13	10	14	10	7	5				
8	36	25	18	13	33	23	17	12	19	14	10	16	11	8	13	9	6	4				
9	33	23	16	11	31	21	15	10	18	12	9	15	10	7	12	8	6	4				
10	31	21	14	10	29	19	13	9	16	11	8	13	9	6	11	7	5	3				

HID/AREA: NEC/CEC EXPLOSIONPROOF

Zone	Lumens	Total Luminaire Efficiency = 66.9%
0-10	249.34	CIE Type – Direct
10-20	810.25	
20-30	1450.35	
30-40	1495.68	
40-50	1920.69	
50-60	2259.61	
60-70	1846.14	
70-80	541.69	
80-90	125.07	
90-100	0.70	
100-110	0.00	
110-120	0.00	
120-130	0.00	
130-140	0.00	
140-150	0.00	
150-160	0.00	
160-170	0.00	
170-180	0.00	

Plane	Spacing Criteria
0-180	1.44
90-270	1.44
Diagonal	1.80

Zonal Lumen Summary			
Zone	Lumens	% Lamp	% Fixture
0-30	2509.94	15.7	23.5
0-40	4005.62	25.0	37.4
0-60	8185.92	51.2	76.5
0-90	10698.82	66.9	100.0
90-120	0.70	0.0	0.0
90-130	0.70	0.0	0.0
90-150	0.70	0.0	0.0
90-180	0.70	0.0	0.0
180-0	10699.52	66.9	100.0

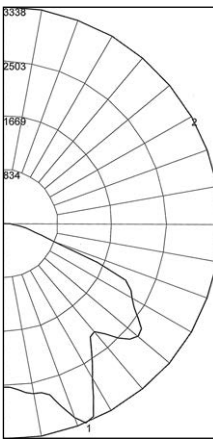

REPORT NUMBER: **CJL15T**

Lamps: 150 W High Pressure Sodium lamp with Standard Dome Reflector

Coefficients of Utilization – Zonal Cavity Method

Effective Floor Cavity Reflectance 0.20

% Ceiling	Rcc	80				70				50				30				10				0
		70	50	30	10	70	50	30	10	50	30	10	50	30	10	50	30	10	0			
0	80	80	80	80	78	78	78	78	74	74	74	71	71	71	68	68	68	67				
1	73	69	66	64	71	68	65	63	65	63	61	62	61	59	60	59	57	56				
2	66	60	55	51	64	59	54	51	56	53	49	54	51	48	52	49	47	46				
3	59	52	46	42	58	51	46	41	49	44	41	47	43	40	45	42	39	38				
4	54	45	39	35	52	45	39	34	43	38	34	41	37	33	40	36	33	31				
5	49	40	34	29	48	39	33	29	38	33	29	37	32	28	35	31	28	27				
6	45	36	30	25	44	35	29	25	34	29	25	33	28	24	32	27	24	23				
7	42	32	26	22	40	32	26	22	31	25	21	30	25	21	29	24	21	20				
8	39	29	23	19	38	29	23	19	28	23	19	27	22	19	26	22	19	17				
9	36	27	21	17	35	26	21	17	25	20	17	25	20	17	24	20	17	15				
10	34	24	19	15	33	24	19	15	23	19	15	23	18	15	22	18	15	14				

Zone	Lumens	Total Luminaire Efficiency = 61.8%
0-10	58.31	CIE Type – Direct
10-20	482.43	
20-30	904.49	
30-40	1163.85	
40-50	1479.08	
50-60	1630.56	
60-70	1467.51	
70-80	1258.91	
80-90	1077.10	
90-100	153.91	
100-110	155.65	
110-120	52.23	
120-130	8.33	
130-140	0.10	
140-150	0.00	
150-160	0.00	
160-170	0.00	
170-180	0.00	

Plane	Spacing Criteria
0-180	2.08
90-270	1.38
Diagonal	1.54

Zonal Lumen Summary			
Zone	Lumens	% Lamp	% Fixture
0-30	1445.23	9.0	14.6
0-40	2609.08	16.3	26.4
0-60	5718.73	35.7	57.8
0-90	9522.24	59.5	96.3
90-120	361.80	2.3	3.7
90-130	370.13	2.3	3.7
90-150	370.23	2.3	3.7
90-180	370.23	2.3	3.7
180-0	9892.48	61.8	100.0

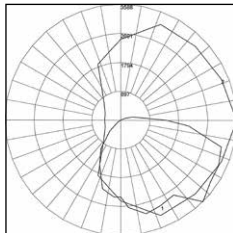

REPORT NUMBER: **CJL15AN**

Lamps: 150 W High Pressure Sodium lamp with 30° Angle Dome Reflector

Coefficients of Utilization – Zonal Cavity Method

Effective Floor Cavity Reflectance 0.20

% Ceiling	Rcc	80				70				50				30				10				0
		70	50	30	10	70	50	30	10	50	30	10	50	30	10	50	30	10	0			
0	73	73	73	73	71	71	71	71	67	67	67	64	64	64	61	61	61	60				
1	64	59	55	52	61	58	54	51	54	51	49	51	49	47	49	47	45	43				
2	56	50	44	40	54	48	43	39	46	41	38	43	39	36	41	38	35	33				
3	51	43	36	31	49	41	36	31	39	34	30	37	33	29	35	31	28	27				
4	46	37	30	25	44	36	30	25	34	29	24	32	28	24	30	26	23	22				
5	42	32	26	21	40	32	25	21	30	25	20	28	24	20	27	23	19	18				
6	38	29	22	18	37	28	22	18	27	21	17	25	21	17	24	20	17	15				
7	35	26	20	15	34	25	19	15	24	19	15	23	18	15	22	17	14	13				
8	33	23	17	13	31	23	17	13	22	17	13	21	16	13	20	16	12	11				
9	30	21	16	12	29	21	15	12	20	15	11	19	14	11	18	14	11	10				
10	28	19	14	10	27	19	14	10	18	13	10	17	13	10	17	13	10	9				

Code•Master™ Jr. HID Factory Sealed Luminaires

Explosionproof, Dust-Ignitionproof

* Photometric data is based on a fixture with a 175-watt clear Pulse Start Metal Halide lamp (14,000 lumen), without guard. For candlepower values of fixtures with other PSMH lamps, use the following multipliers: for a 100 W (8,500 lumen) PSMH lamp – 0.607; for a 70 W (5,000 lumen) PSMH lamp – 0.357. For candlepower values of fixture with guard, multiply by – 0.95.

NEC:

Class I, Division 1 and 2, Groups B, C, D
Class II, Division 1 and 2, Groups E, F, G
Class III
Marine type electric fixtures, outside type
(salt water)

CEC:

Class I, Division 1 and 2, Groups B, C, D
Class II, Division 1 and 2, Groups E, F, G
Class III
Type 4X
Exd IIB + H₂

PSMH Photometric Data

Zone	Lumens	Total Luminaire Efficiency = 77.8%
0-10	46.64	CIE Type – General Diffuse
10-20	176.99	
20-30	380.01	
30-40	480.30	
40-50	1042.35	
50-60	1252.88	
60-70	1378.40	
70-80	1611.81	
80-90	1741.68	
90-100	1758.28	
100-110	1643.71	
110-120	1371.76	
120-130	694.24	
130-140	27.13	
140-150	3.14	
150-160	0.67	
160-170	0.08	
170-180	0.03	

Zonal Lumen Summary				
Zone	Lumens	% Lamp	% Fixture	
0-30	603.64	3.4	4.4	
0-40	1083.94	6.2	8.0	
0-60	3379.18	19.3	24.8	
0-90	8111.07	46.3	59.6	
90-120	4773.75	27.3	35.1	
90-130	5467.99	31.2	40.2	
90-150	5498.26	31.4	40.2	
90-180	5499.05	31.4	40.4	
180-0	13610.12	77.8	100.0	

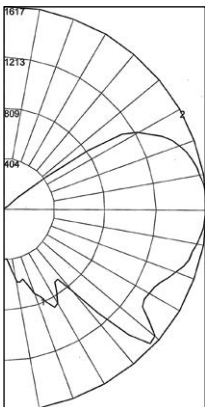

REPORT NUMBER: CJP17G

Lamps: 175 W Pulse Start Metal Halide with Globe only *

Coefficients of Utilization – Zonal Cavity Method

Effective Floor Cavity Reflectance 0.20

% Ceiling	Rcc	80						70						50						30						10						0
		% Walls	Rw	70	50	30	10	70	50	30	10	50	30	10	50	30	10	50	30	10	50	30	10	0								
0	85	85	85	85	79	79	79	79	69	69	69	59	59	59	51	51	51	46														
1	73	67	62	58	67	62	58	54	53	49	46	45	42	39	37	35	33	29														
2	64	56	49	43	59	52	45	40	44	39	35	36	32	29	30	27	24	20														
3	57	48	40	34	53	44	37	31	37	31	27	31	26	22	25	21	18	15														
4	52	41	33	27	48	38	31	25	32	26	22	26	22	18	21	17	14	12														
5	47	36	28	22	43	33	26	21	28	22	18	23	18	15	19	15	12	9														
6	43	32	24	19	40	29	23	18	25	19	15	20	16	12	16	13	10	7														
7	40	28	21	16	36	26	20	15	22	17	13	18	14	10	15	11	8	6														
8	37	26	19	14	34	24	17	13	20	15	11	17	12	9	13	10	7	5														
9	34	23	17	12	31	21	15	11	18	13	9	15	11	8	12	9	6	4														
10	32	21	15	11	29	20	14	10	17	12	8	14	10	7	11	8	5	4														

Zone	Lumens	Total Luminaire Efficiency = 66.4%
0-10	281.17	CIE Type – Direct
10-20	914.71	
20-30	1567.70	
30-40	1691.30	
40-50	2211.91	
50-60	2339.53	
60-70	1900.87	
70-80	568.93	
80-90	145.98	
90-100	1.23	
100-110	0.00	
110-120	0.00	
120-130	0.00	
130-140	0.00	
140-150	0.00	
150-160	0.00	
160-170	0.00	
170-180	0.00	

Spacing Criteria	
Plane	Spacing Criteria
0-180	1.42
90-270	1.42
Diagonal	1.76

Zonal Lumen Summary				
Zone	Lumens	% Lamp	% Fixture	
0-30	2763.57	15.8	23.8	
0-40	4454.87	25.5	38.3	
0-60	9006.31	51.5	77.5	
0-90	11622.09	66.4	100.0	
90-120	1.23	0.0	0.0	
90-130	1.23	0.0	0.0	
90-150	1.23	0.0	0.0	
90-180	1.23	0.0	0.0	
180-0	11623.32	66.4	100.0	

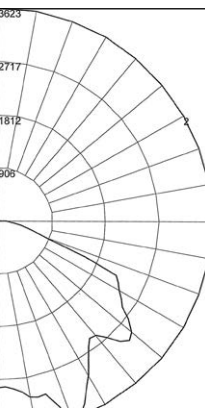

REPORT NUMBER: CJP17ST

Lamps: 175 W Pulse Start Metal Halide with Standard Dome Reflector *

Coefficients of Utilization – Zonal Cavity Method

Effective Floor Cavity Reflectance 0.20

% Ceiling	Rcc	80						70						50						30						10						0
		% Walls	Rw	70	50	30	10	70	50	30	10	50	30	10	50	30	10	50	30	10	50	30	10	0								
0	79	79	79	79	77	77	77	77	74	74	74	71	71	71	68	68	68	66														
1	72	69	66	64	70	67	65	63	65	63	61	62	60	59	60	58	57	56														
2	65	60	55	51	64	58	54	51	56	52	49	54	51	48	52	49	47	46														
3	59	52	46	42	57	51	46	41	49	44	41	47	43	40	45	42	39	38														
4	54	46	39	35	52	45	39	35	43	38	34	41	37	34	40	36	33	32														
5	49	40	34	29	48	40	34	29	38	33	29	37	32	29	35	31	28	27														
6	45	36	30	25	44	35	29	25	34	29	25	33	28	25	32	28	24	23														
7	42	32	26	22	41	32	26	22	31	26	22	30	25	22	29	25	21	20														
8	39	29	23	19	38	29	23	19	28	23	19	27	22	19	26	22	19	18														
9	36	27	21	17	35	26	21	17	26	21	17	25	20	17	24	20	17	16														
10	34	25	19	16	33	24	19	16	24	19	15	23	18	15	22	18	15	14														

Zone	Lumens	Total Luminaire Efficiency = 63.2%
0-10	238.28	CIE Type – Direct
10-20	739.68	
20-30	1242.92	
30-40	1491.36	
40-50	1770.34	
50-60	1739.56	
60-70	1484.79	
70-80	1197.57	
80-90	689.02	
90-100	254.20	
100-110	105.48	
110-120	35.72	
120-130	41.95	
130-140	8.72	
140-150	6.06	
150-160	4.53	
160-170	2.20	
170-180	0.68	

Spacing Criteria	
Plane	Spacing Criteria
0-180	2.10
90-270	1.60
Diagonal	1.62

Zonal Lumen Summary				
Zone	Lumens	% Lamp	% Fixture	
0-30	2220.87	12.7	20.1	
0-40	3712.23	21.2	33.6	
0-60	7222.13	41.3	65.3	
0-90	10593.52	60.5	95.8	
90-120	395.41	2.3	3.6	
90-130	437.36	2.5	4.0	
90-150	452.13	2.6	4.0	
90-180	459.54	2.6	4.2	
180-0	11053.05	63.2	100.0	

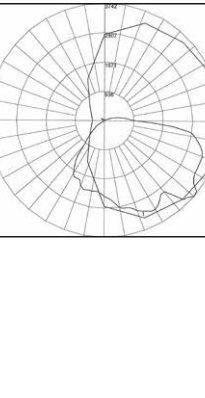

REPORT NUMBER: CJP17AN

Lamps: 175 W Pulse Start Metal Halide with 30° Angle Dome Reflector *

Coefficients of Utilization – Zonal Cavity Method

Effective Floor Cavity Reflectance 0.20

% Ceiling	Rcc	80						70						50						30						10						0
		% Walls	Rw	70	50	30	10	70	50	30	10	50	30	10	50	30	10	50	30	10	50	30	10	0								
0	75	75	75	75	73	73	73	73	69	69	69	65	65	65	62	62	62	61														
1	66	63	59	56	64	61	58	55	58	55	53	55	53	51	52	50	49	47														
2	60	53	48	44	58	52	47	43	49	45	42	47	43	41	44	42	39	38														
3	54	46	40	36	52	45	40	35	43	38	34	41	37	33	39	35	32	31														
4	49	41	34	30	47	39	34	29	38	33	29	36	31	28	34	30	27	26														
5	45	36	30	25	43	35	29	25	33	28	24	32	27	24	30	26	23	22														
6	41	32	26	22	40	31	26	21	30	25	21	29	24	21	27	23	20	19														
7	38	29	23	19	37	28	23	19	27	22	18	26	21	18	25	21	18	16														
8	35	26	21	17	34	26	20	17	25	20	16	24	19	16	23	19	16	14														
9	33	24	19	15	32	24	18	15	23	18	15	22	17	14	21	17	14	13														
10	31	22	17	13	30	22	17	13	21	16	13	20	16	13	19	15	13	12														

Mercmaster™ ATEX LN Series Wellglass Luminaires

Zone 2 and 22

ATEX/IECEX:
Zone 2 and 22
II 3 GD
IP66

Applications

- Enclosed and gasketed fixtures suitable for use in:
 - Marine and wet locations
 - Areas where flammable gases, vapors or combustible dusts are present under conditions defined by the IEC as Zone 2 and 22
 - Applications where energy efficient, high lumen output is required
 - Non-hazardous locations where severe weather conditions, excessive moisture, dirt, dust, corrosive atmosphere or high ambient temperatures are encountered
- Typical applications include:
 - Pulp and paper mills
 - Processing plants
 - Chemical plants
 - Oil refineries
 - Foundries
 - Manufacturing plants
 - Storage areas
 - Waste and sewage treatment
 - Other areas where dust, water, dirt and rough usage are a problem

Features

- Power supply 230/240 V (+6% - 10%) 50 Hz.
- Instant relighting with auxiliary halogen lamps, depending on model (lamps not supplied).
- Fast relighting for 70 W and 150 W high pressure sodium: 5 to 30 seconds depending on the duration of the mains power supply failure.
- Connection via terminal block — 2 x 4 mm² (0.003 x 0.006 in²) maximum.
- Superior corrosion-resistance: copperfree die-cast mounting hoods, ballast housing and guards have a gray epoxy powder coat, electrostatically applied for complete and uniform protection.
- Wide choice of light sources: high pressure sodium, metal halide, mercury vapor and incandescent.
- Six mounting arrangements to suit any lighting layout – pendant, ceiling, wall bracket, angled or straight stanchion and pendant cone (for dust applications).
- Hinge has high lip for added safety during installation and servicing. Hinge and bolt construction assures 360° compression at all points on ballast housing gasket for positive sealing. Swing away design of captive bolt and nut simplifies servicing.
- All fixtures designed to perform in a -40 °C (-40 °F) ambient temperature up to +55 °C (+131 °F).
- Standard dome or 30° angle reflectors made of fiberglass reinforced white polyester. Highly resistant to corrosive atmospheres and vented to improve fixture cooling characteristics.
- Fixture housing mounting hoods and guards are die-cast copperfree aluminum with epoxy powder coat finish.
- All exposed hardware is stainless steel and captive. Stainless thread inserts in the ballast bodies prevent “freezing” of the screws that affix guards and reflectors, simplifying removal for service.
- One piece ballast housing for each component provides even heat dissipation for cooler operation and longer ballast life.
- Fixture bodies are provided with two silicone rubber O-Ring style gaskets that will stay flexible and assure even compression around their circumference. They easily withstand high temperatures, moisture, dirt and dust for worry free operation.



Low Profile Ceiling Mount with Prismatic Globe and Optional Guard



50–200 Watt 25° Stanchion Mount with Prismatic Globe



50–200 Watt 90° Stanchion Mount with Prismatic Globe and Optional Guard



400 Watt Straight Stanchion Mount with Prismatic Glass Globe and Optional Guard

Standard Materials

- Mounting hoods and ballast bodies: die-cast copperfree (4/10 of 1% max.) aluminum
- Hardware and catch assemblies: stainless steel
- Globe: heat and impact resistant internally fluted glass
- Gasket: high temperature silicon
- Reflector: fiberglass reinforced polyester
- Guards: polyester powder coat finished cast copperfree aluminum (LN1 and LN2 sizes) or stainless steel (LN3 and LN4 sizes)

Standard Finishes

- Mounting hoods, ballast bodies and guards: epoxy powder coat finish, electrostatically applied for complete, uniform surface protection
- Reflectors: white polyester finish

HID/AREA: ATEX/IECEX RESTRICTED BREATHING DUST

Appleton

Mercmaster™ ATEX LN Series Wellglass Luminaires

Zone 2 and 22

ATEX/IECEX:
Zone 2 and 22
II 3 GD
IP66

ATEX/IECEX Certifications and Compliances

- Certification Type: LN
 - Gas: Zone 2
 - Conforming to ATEX 94/9/CE: II 3 G
 - Type of Protection: Ex nR IIC Gc
- Certification Type: LN
 - Dust: Zone 22
 - Conforming to ATEX 94/9/CE: II 3 D
 - Type of Protection: Ex tc IIIC Dc

- Ambient Temperature: +40 °C to +55 °C (+104 °F to +131 °F)
- CE Declaration of Conformity: 50217
- ATEX Certificate: LCIE 08 ATEX 6036X
- IECEx Certificate: IECEx LCI 10.0041X
- Index of Protection according EN/IEC 60529: IP66

EURASEC Certification

- EURASEC N° TC RU C-FR.Г505.B.00912

Order using catalog numbering guide below or select catalog number from tables on following pages.

Catalog Numbering Guide for LN Series Luminaires

LN Series: LN - LN Series Zone 2 and 22 ATEX/IECEX Certified	1 Body Size: 1 - Size 1 (MLBG) 2 - Size 2 (KPB) 3 - Size 3 (KPBR) 4 - Size 4 (KPB400)	A Mounting: A - Pendant (Rigid Mounting) C - Ceiling D - Pendant Cone F - Pendant (Flexible Mounting) R - Straight Stanchion S - 25° Stanchion W - Wall	H Lamp Type ①: H - Metal Halide L - High Pressure Sodium M - Mercury Vapor Q - Induction Z - Halogen/ Incandescent	70 Lamp Wattage: 70 - 70 W 80 - 80 W 85 - 85 W Induction only 10 - 100 W 12 - 125 W 15 - 150 W 25 - 250 W 40 - 400 W	A Hub Size: A - M20 2 - 3/4" NPT 3 - 1" NPT 4 - 1-1/4" NPT 5 - 1-1/2" NPT	G2 Globe: G2 - Glass Globe VPGL-2HR G4 - Glass Globe VPGL-4HR	XA Voltage (Magnetic Ballast): XA - 220 Vac, 50 Hz XJ - 230/240 Vac, 50 Hz	P Options: P - PTFE Coating
---	---	---	--	---	--	---	--	--

HID/AREA: ATEX/IECEX RESTRICTED BREATHING DUST

Appleton®

① Mercury vapor and metal halide luminaires are not available for purchase within the United States. Please check with your countries governing legislation regarding allowable lamp types before ordering.

Mercmaster™ ATEX LN Series Wellglass Luminaires

Zone 2 and 22

ATEX/IECEX:
Zone 2 and 22
II 3 GD
IP66

T Rating (Gas) and Surface Temperature (Dust) Table Rating

Lamp Wattage/Type		Gas			Dust	
		Zone 2 T Rating Ambient Temperatures			Zone 22 Surface Temperature for Ambient T° = +55 °C (+131 °F)	
		+40 °C (+104 °F)	+50 °C (+122 °F)	+55 °C (+131 °F)	Dust Surface	Cable
70 W HPS	T Rating	T4	T4	T4	+113 °C (+235 °F)	—
100 W HPS	T Rating	T4	T3	T3	+143 °C (+289 °F)	—
100 W Incandescent	T Rating	T4	T3	T3	+143 °C (+289 °F)	—
100 W Halogen	T Rating	T4	T3	T3	+143 °C (+289 °F)	—
125 W Mercury	T Rating	T4	T3	T3	+143 °C (+289 °F)	—
150 W HPS	T Rating	T4	T3	T3	+143 °C (+289 °F)	—
150 W Halide	T Rating	T4	T3	T3	+143 °C (+289 °F)	—
150 W Incandescent	T Rating	T4	T3	T3	+143 °C (+289 °F)	—
150 W Halogen	T Rating	T4	T3	T3	+143 °C (+289 °F)	—
250 W HPS	T Rating	T4	T4	T3	+137 °C (+279 °F)	—
250 W Halide	T Rating	T4	T3	T3	+143 °C (+289 °F)	—
250 W Mercury	T Rating	T4	T3	T3	+143 °C (+289 °F)	—
400 W HPS	T Rating	T3	T3	T3	+167 °C (+333 °F)	+89 °C (+192 °F)
	Cable T°	—	+84 °C (+183 °F)	+89 °C (+192 °F)		
400 W Halide	T Rating	T3	T3	T3	+171 °C (+340 °F)	+87 °C (+189 °F)
	Cable T°	—	+82 °C (+180 °F)	+87 °C (+189 °F)		
400 W Mercury	T Rating	T3	T3	T3	+171 °C (+340 °F)	+89 °C (+192 °F)
	Cable T°	—	+84 °C (+183 °F)	+89 °C (+192 °F)		

“T” Numbers Represent the Maximum Lamp Temperature Locations and Maximum Surface Temperature Under Dust Blanket.







“T” Number	T1	350	325	T2	T2A	T2B	T2C	T2D	T3	T3A	T3B	T3C	T4	T4A	T5	T6
Temp. Range (°C)	351-450	326-350	301-325	281-300	261-280	231-260	216-230	201-215	181-200	166-180	161-165	136-160	121-135	101-120	86-100	85
Temp. Range (°F)	664-842	619-662	574-617	538-572	502-536	448-500	421-446	394-419	358-392	331-356	322-329	277-320	250-275	214-248	187-212	185

① Mercury vapor and metal halide luminaires are not available for purchase within the United States. Please check with your countries governing legislation regarding allowable lamp types before ordering.

Mercmaster™ ATEX LN Series Wellglass Luminaires

Zone 2 and 22. High Pressure Sodium

ATEX/IECEX:
Zone 2 and 22
II 3 GD
IP66

	Lamp Type	Cable Entry	Lamp Watts	Lampholder	Weight kg (lb)	Volume dm ³ (in ³)	Catalog Number
Pendant							
	HPS	1 x 3/4" NPT	70	E27	7.4 (16.31)	39.0 (2379.93)	LN1AL702G2XJ
			100	E40	9.0 (19.84)	55.0 (3356.31)	LN2AL102G2XJ
			150	E40	9.0 (19.84)	55.0 (3356.31)	LN2AL152G2XJ
			250	E40	16.0 (35.27)	70.0 (4271.66)	LN3AL252G4XJ
			400	E40	19.0 (41.89)	85.2 (5199.22)	LN4AL402G4XJ
Pendant Cone							
	HPS	1 x 3/4" NPT	70	E27	7.4 (16.31)	39.0 (2379.93)	LN1DL702G2XJ
			100	E40	9.0 (19.84)	55.0 (3356.31)	LN2DL102G2XJ
			150	E40	9.0 (19.84)	55.0 (3356.31)	LN2DL152G2XJ
			250	E40	16.0 (35.27)	70.0 (4271.66)	LN3DL252G4XJ
			400	E40	19.0 (41.89)	85.2 (5199.22)	LN4DL402G4XJ
Ceiling							
	HPS	5 x 1" NPT with: - 4 x 1" NPT fitted plugs - 2 x 1" NPT-M20 adaptors - 2 x M20 plugs	70	E27	7.4 (16.31)	39.0 (2379.93)	LN1CL70AG2XJ
			100	E40	9.0 (19.84)	55.0 (3356.31)	LN2CL10AG2XJ
			150	E40	9.0 (19.84)	55.0 (3356.31)	LN2CL15AG2XJ
			250	E40	16.0 (35.27)	70.0 (4271.66)	LN3CL25AG4XJ
			400	E40	19.0 (41.89)	85.2 (5199.22)	LN4CL40AG4XJ
Wall							
	HPS	5 x 1" NPT with: - 4 x 1" NPT fitted plugs - 2 x 1" NPT-M20 adaptors - 2 x M20 plugs	70	E27	7.4 (16.31)	39.0 (2379.93)	LN1WL70AG2XJ
			100	E40	9.0 (19.84)	55.0 (3356.31)	LN2WL10AG2XJ
			150	E40	9.0 (19.84)	55.0 (3356.31)	LN2WL15AG2XJ
			250	E40	16.0 (35.27)	70.0 (4271.66)	LN3WL25AG4XJ
			400	E40	19.0 (41.89)	85.2 (5199.22)	LN4WL40AG4XJ
25° Angled Stanchion							
	HPS	1 x 1- 1/4" NPT	70	E27	7.4 (16.31)	39.0 (2379.93)	LN1SL704G2XJ
			100	E40	9.0 (19.84)	55.0 (3356.31)	LN2SL104G2XJ
			150	E40	9.0 (19.84)	55.0 (3356.31)	LN2SL154G2XJ
			250	E40	16.0 (35.27)	70.0 (4271.66)	LN3SL254G4XJ
			400	E40	19.0 (41.89)	85.2 (5199.22)	LN4SL404G4XJ
Straight Stanchion							
	HPS	1 x 1- 1/4" NPT	70	E27	7.4 (16.31)	39.0 (2379.93)	LN1RL704G2XJ
			100	E40	9.0 (19.84)	55.0 (3356.31)	LN2RL104G2XJ
			150	E40	9.0 (19.84)	55.0 (3356.31)	LN2RL154G2XJ
			250	E40	16.0 (35.27)	70.0 (4271.66)	LN3RL254G4XJ
			400	E40	19.0 (41.89)	85.2 (5199.22)	LN4RL404G4XJ







HID/AREA: ATEX/IECEX RESTRICTED BREATHING DUST

Appleton

Mercmaster™ ATEX LN Series Wellglass Luminaires

Zone 2 and 22. Incandescent/Halogen

ATEX/IECEX:
Zone 2 and 22
II 3 GD
IP66

	Lamp Type	Cable Entry	Lamp Watts	Lampholder	Weight kg (lb)	Volume dm ³ (in ³)	Catalog Number
Pendant							
	Inc./	1 x 3/4" NPT	100	E27	7.4 (16.31)	39.0 (2379.93)	LN1AZ102G2
	Halogen		150	E27	7.4 (16.31)	39.0 (2379.93)	LN1AZ152G2
Pendant Cone							
	Inc./	1 x 3/4" NPT	100	E27	7.4 (16.31)	39.0 (2379.93)	LN1DZ102G2
	Halogen		150	E27	7.4 (16.31)	39.0 (2379.93)	LN1DZ152G2
Ceiling							
	Inc./	5 x 1" NPT with: - 4 x 1" NPT fitted plugs - 2 x 1" NPT-M20 adaptors - 2 x M20 plugs	100	E27	7.4 (16.31)	39.0 (2379.93)	LN1CZ10AG2
	Halogen		150	E27	7.4 (16.31)	39.0 (2379.93)	LN1CZ15AG2
Wall							
	Inc./	5 x 1" NPT with: - 4 x 1" NPT fitted plugs - 2 x 1" NPT-M20 adaptors - 2 x M20 plugs	100	E27	7.4 (16.31)	39.0 (2379.93)	LN1WZ10AG2
	Halogen		150	E27	7.4 (16.31)	39.0 (2379.93)	LN1WZ15AG2
25° Angled Stanchion							
	Inc./	1 x 1-1/4" NPT	100	E27	7.4 (16.31)	39.0 (2379.93)	LN1SZ104G2
	Halogen		150	E27	7.4 (16.31)	39.0 (2379.93)	LN1SZ154G2
Straight Stanchion							
	Inc./	1 x 1-1/4" NPT	100	E27	7.4 (16.31)	39.0 (2379.93)	LN1RZ104G2
	Halogen		150	E27	7.4 (16.31)	39.0 (2379.93)	LN1RZ154G2





HID/AREA: ATEX/IECEX RESTRICTED BREATHING DUST

Appleton®

Mercmaster™ ATEX LN Series Wellglass Luminaires

Zone 2 and 22. Mercury Vapor

ATEX/IECEX:
Zone 2 and 22
II 3 GD
IP66







	Lamp Type ①	Cable Entry	Lamp Watts	Lampholder	Weight kg (lb)	Volume dm³ (in³)	Catalog Number
Pendant							
	MV	1 x 3/4" NPT	150	E27	7.4 (16.31)	39.0 (2379.93)	LN1AM122G2XJ
			250	E40	14.0 (30.86)	70.0 (4271.66)	LN3AM252G4XJ
			400	E40	19.0 (41.89)	85.2 (5199.22)	LN4AM402G4XJ
Pendant Cone							
	MV	1 x 3/4" NPT	150	E27	7.4 (16.31)	39.0 (2379.93)	LN1DM122G2XJ
			250	E40	14.0 (30.86)	70.0 (4271.66)	LN3DM252G4XJ
			400	E40	19.0 (41.89)	85.2 (5199.22)	LN4DM402G4XJ
Ceiling							
	MV	5 x 1" NPT with: - 4 x 1" NPT fitted plugs - 2 x 1" NPT-M20 adaptors - 2 x M20 plugs	150	E27	7.4 (16.31)	39.0 (2379.93)	LN1CM12AG2XJ
			250	E40	14.0 (30.86)	70.0 (4271.66)	LN3CM25AG4XJ
			400	E40	19.0 (41.89)	85.2 (5199.22)	LN4CM40AG4XJ
Wall							
	MV	5 x 1" NPT with: - 4 x 1" NPT fitted plugs - 2 x 1" NPT-M20 adaptors - 2 x M20 plugs	150	E27	7.4 (16.31)	39.0 (2379.93)	LN1WM12AG2XJ
			250	E40	14.0 (30.86)	70.0 (4271.66)	LN3WM25AG4XJ
			400	E40	19.0 (41.89)	85.2 (5199.22)	LN4WM40AG4XJ
25° Angled Stanchion							
	MV	1 x 1-1/4" NPT	150	E27	7.4 (16.31)	39.0 (2379.93)	LN1SM124G2XJ
			250	E40	14.0 (30.86)	70.0 (4271.66)	LN3SM254G4XJ
			400	E40	19.0 (41.89)	85.2 (5199.22)	LN4SM404G4XJ
Straight Stanchion							
	MV	1 x 1-1/4" NPT	150	E27	7.4 (16.31)	39.0 (2379.93)	LN1RM124G2XJ
			250	E40	14.0 (30.86)	70.0 (4271.66)	LN3RM254G4XJ
			400	E40	19.0 (41.89)	85.2 (5199.22)	LN4RM404G4XJ

① Mercury vapor and metal halide luminaires are not available for purchase within the United States. Please check with your countries governing legislation regarding allowable lamp types before ordering.

Mercmaster™ ATEX LN Series Wellglass Luminaires

Zone 2 and 22. Metal Halide

ATEX/IECEX:
Zone 2 and 22
II 3 GD
IP66





	Lamp Type ①	Cable Entry	Lamp Watts	Lampholder	Weight kg (lb)	Volume dm³ (in³)	Catalog Number
Pendant							
	MH	1 x 3/4" NPT	150	E40	9.0 (19.84)	55.0 (3356.31)	LN2AH152G2XJ
			250	E40	16.0 (35.27)	70.0 (4271.66)	LN3AH252G4XJ
			400	E40	19.0 (41.89)	85.2 (5199.22)	LN4AH402G4XJ
Pendant Cone							
	MH	1 x 3/4" NPT	150	E40	9.0 (19.84)	55.0 (3356.31)	LN2DH152G2XJ
			250	E40	16.0 (35.27)	70.0 (4271.66)	LN3DH252G4XJ
			400	E40	19.0 (41.89)	85.2 (5199.22)	LN4DH402G4XJ
Ceiling							
	MH	5 x 1" NPT with: - 4 x 1" NPT fitted plugs - 2 x 1" NPT-M20 adaptors - 2 x M20 plugs	150	E40	9.0 (19.84)	55.0 (3356.31)	LN2CH15AG2XJ
			250	E40	16.0 (35.27)	70.0 (4271.66)	LN3CH25AG4XJ
			400	E40	19.0 (41.89)	85.2 (5199.22)	LN4CH40AG4XJ
Wall							
	MH	5 x 1" NPT with: - 4 x 1" NPT fitted plugs - 2 x 1" NPT-M20 adaptors - 2 x M20 plugs	150	E40	9.0 (19.84)	55.0 (3356.31)	LN2WH15AG2XJ
			250	E40	16.0 (35.27)	70.0 (4271.66)	LN3WH25AG4XJ
			400	E40	19.0 (41.89)	85.2 (5199.22)	LN4WH40AG4XJ
25° Angled Stanchion							
	MH	1 x 1-1/4" NPT	150	E40	9.0 (19.84)	55 (3356.31)	LN2SH154G2XJ
			250	E40	16.0 (35.27)	70 (4271.66)	LN3SH254G4XJ
			400	E40	19.0 (41.89)	85.2 (5199.22)	LN4SH404G4XJ
Straight Stanchion							
	MH	1 x 1-1/4" NPT	150	E40	9.0 (19.84)	55 (3356.31)	LN2RH154G2XJ
			250	E40	16.0 (35.27)	70 (4271.66)	LN3RH254G4XJ
			400	E40	19.0 (41.89)	85.2 (5199.22)	LN4RH404G4XJ

① Mercury vapor and metal halide luminaires are not available for purchase within the United States. Please check with your countries governing legislation regarding allowable lamp types before ordering.

Mercmaster™ ATEX LN Series Wellglass Luminaires

Zone 2 and 22

ATEX/IECEX:
Zone 2 and 22
II 3 GD
IP66

Item	Description	Catalog Number
White Polyester Reflectors		
For Globe Fixtures – LN1 and LN2 sizes		
 Standard Dome	Standard Dome	KR2-ST
	30° Angle	KR2-AN
For Glass Refractor Fixtures – LN3 and LN4 sizes		
 Standard Dome	Standard Dome	CMR-4ST
	30° Angle	CMR-4AN
Guards		
For Globe Fixtures – LN1 and LN2 sizes		
 Globe Guard	Aluminium	KRGU2
	For Glass Refractor Fixtures – LN3 and LN4 sizes	
 Globe Guard	Stainless Steel	KPGU400

HID/AREA: ATEX/IECEX RESTRICTED BREATHING DUST

Appleton®

Mercmaster™ ATEX LN Series Wellglass Luminaires

Zone 2 and 22

ATEX/IECEX:
Zone 2 and 22
II 3 GD
IP66

Dimensions in Millimeters (Inches)

Ballast Body with Globe

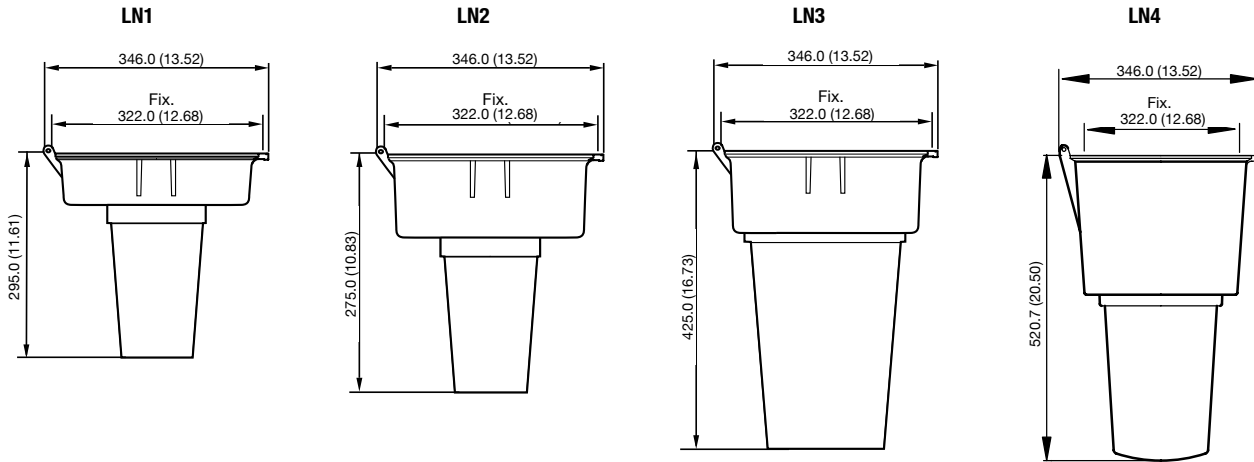

Mounting Hoods

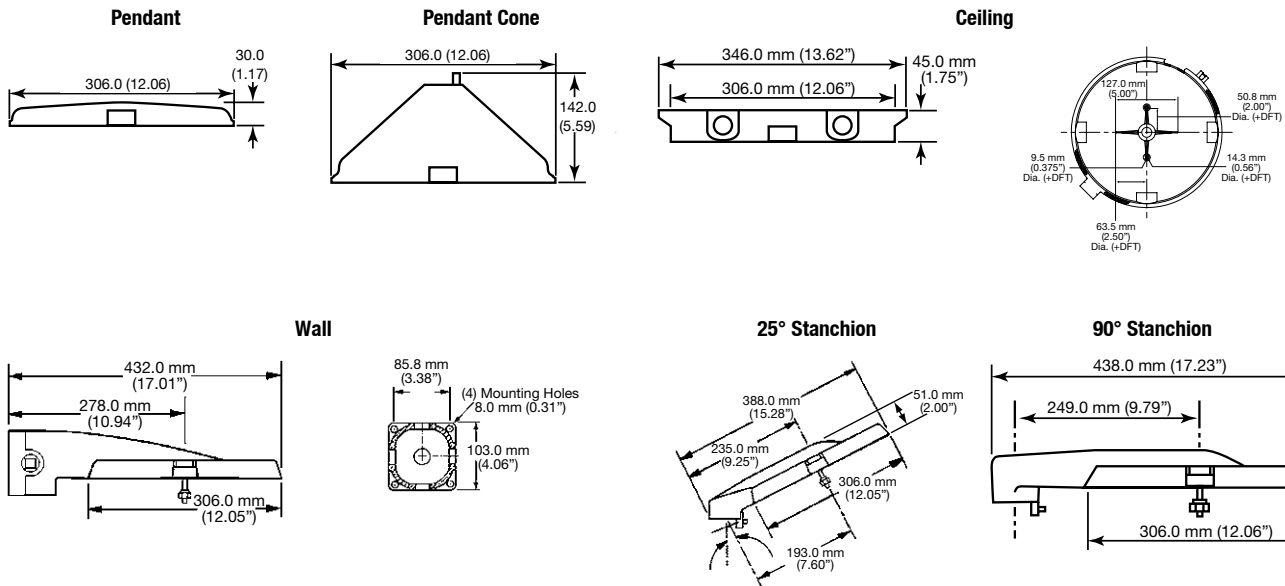

HID/AREA: ATEX/IECEX RESTRICTED BREATHING DUST

Appleton®

Mercmaster™ ATEX LN Series Wellglass Luminaires

Zone 2 and 22

ATEX/IECEX:
 Zone 2 and 22
 II 3 GD
 IP66

Photometric Data

Polar curves for a 1000 lm flux, according to NF C 71-120
 Luminaire symbol according to NF C 71-121

--- Longitudinal
 — Transverse

High Pressure Sodium

70 W HP Sodium — Efficiency 74.6%

150 W HP Sodium — Efficiency 87.3%

250 W HP Sodium — Efficiency 89.1%

400 W HP Sodium — Efficiency 82.3%

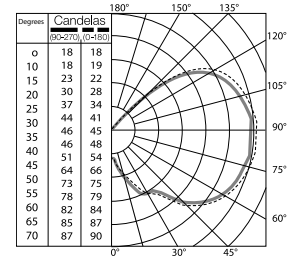
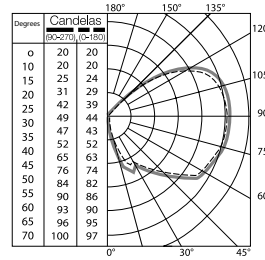
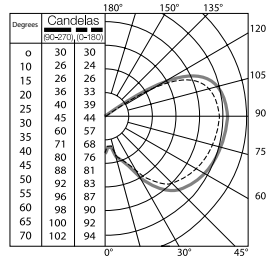
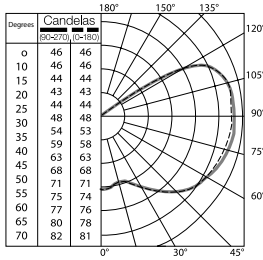

Metal Halide

150 W Metal Halide — Efficiency 82.4%

250 W Metal Halide — Efficiency 96.2%

400 W Metal Halide — Efficiency 89.8%

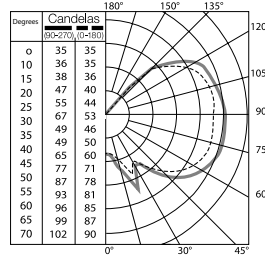
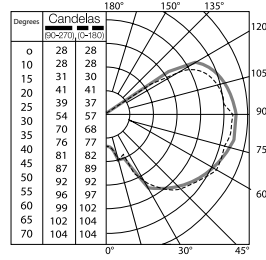
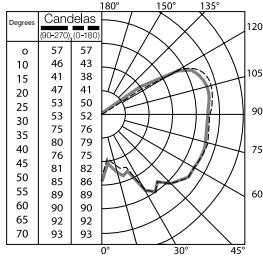

Incandescent or Halogen

150 W HP Incandescent Halogen — Efficiency 90.6%

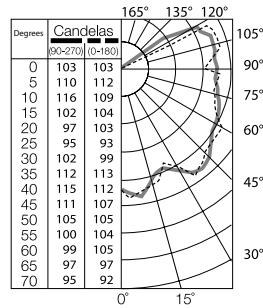

Mercury Vapor

250 W Mercury Vapor — Efficiency 76%

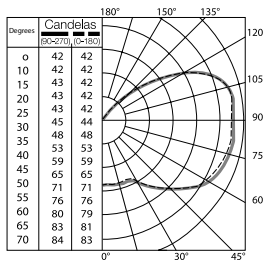

HID/AREA: ATEX/IECEX RESTRICTED BREATHING DUST



Baymaster™ Prismatic 250/400 High Bay Luminaires

150 W, 250 W, 400 W HPS.

NEC/CEC:

Listed for Ordinary (Unclassified) Locations

Applications

- For illumination of manufacturing, storage, and other indoor areas.

Features

- Standard Baymaster fixtures operate in +40 °C (+104 °F) ambient temperatures. All units suitable for minimum +90 °C (+194 °F) supply wire.
- High efficiency (up to 78% with 250 W HPS lamps) with exceptionally long lamp life—economical to own and operate.
- A wide range of ballasts and voltages are available for both domestic and export applications.
- Integral ballast.
- Mogul base sockets with spring loaded center contact and heavy gauge screw shell with double lamp grips to prevent lamps from loosening due to vibration.
- Efficient, low glare, compact reflector is UV stabilized, clear, injection molded high-temperature acrylic that provides 15-20% uplight.
- Reflector installs and adjusts to wide, medium, or narrow distribution (without tools) by repositioning spring locks.
- Installation is quick and easy:
 - (1) mount junction box to 3/4" conduit
 - (2) slide ballast onto junction box
 - (3) make connections
 - (4) install lamp
 - (5) snap reflector in place
- Open-top reflector design keeps reflector clean because of thermal barrier and chimney effect, and provides up-light to relieve contrast.

Standard Materials

- Ballast: finned, aluminum
- Sockets: heavy duty porcelain
- Reflector: acrylic
- Locks: stainless steel

Standard Finishes

- Ballast: corrosion polyester
- Sockets: nickel plated center contact
- Screws: nickel plated brass

Options

- All units available with a sensor circuit for automatically lighting an auxiliary safety lamp if a power dip or lamp failure extinguishes the HID lamp.

NEC/CEC Certifications and Compliances

- UL Listed: E109438
- UL Standard: 1598
- CSA Certified: LR9349

Related Products

- For power hook, fusing and other suspension accessories, see *Fixture Hanger Accessories* page.



Dimensions in Millimeters (Inches)

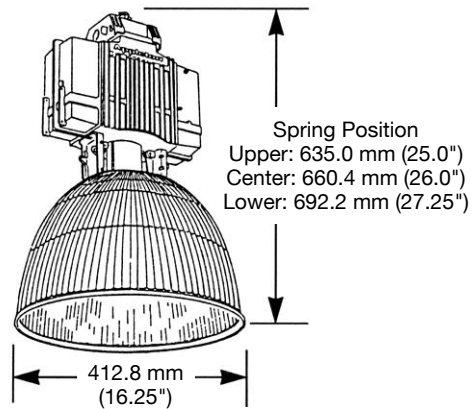

Baymaster™ Prismatic 250/400 High Bay Luminaires

150 W, 250 W, 400 W HPS.

NEC/CEC:

Listed for Ordinary (Unclassified) Locations

High Pressure Sodium Lamps — Pendant Mounting

Lamp Wattage	Voltage	Catalog Number	
		Complete Assembly ①	Ballast Housing Assembly
150 W	120/208/240/277 V	G-HB41PL-MT	G-HB411L-MT
	120/277/347 V	G-HB41PL-TT ③②	G-HB411L-TT ③②
	480	G-HB41PL-48	G-HB411L-48
250 W	120/208/240/277 V	G-HB61PL-MT	G-HB611L-MT
	120/277/347 V	G-HB61PL-TT ③②	G-HB611L-TT ③②
	480	G-HB61PL-48	G-HB611L-48
400 W	120/208/240/277 V	G-HB71PL-MT	G-HB711L-MT
	120/277/347 V	G-HB71PL-TT ③②	G-HB711L-TT ③②
	480	G-HB71PL-48	G-HB711L-48

Accessories

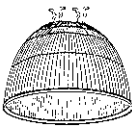
	Description	Catalog Number
	16" Prismatic Reflector only.	G-7PR
	16" Prismatic Reflector with clamp band and clear tempered glass lens.	G-7PR-IL ③
	16" Prismatic Reflector with clamp band and prismatic acrylic lens.	G-7PR-ILP ③

① To order fixture complete with lamp, add suffix **-L** to catalog number.

Add suffix **-E** to catalog number if provision for 150 W quartz emergency lamp is desired (lamp not included). Furnished with socket installed and pre-wired.

② Supplied complete with CWA Ballast. For 208, 240, 480 or 600 V CWI applications, change the **-TT** suffix to **-C2**, **-C3**, **-C6** or **-C7** as required.

③ Certified to meet the Canadian Electrical Code (CEC) only.

Baymaster™ Prismatic 250/400 High Bay Luminaires

150 W, 250 W, 400 W HPS.

NEC/CEC:

Listed for Ordinary (Unclassified) Locations

Electrical Specifications – High Pressure Sodium – All ballasts are C.W.A. type, except 150 W HPS which is HX-Auto

• Ballast has primary taps for 120, 208, 240 and 277 Volts.

Line Volts	150 Watt			250 Watt			400 Watt		
	Start	Operating	Total Watts	Start	Operating	Total Watts	Start	Operating	Total Watts
120	2.00	1.70	188	2.00	2.50	295	3.30	3.80	465
208	1.15	0.95	188	1.20	1.50	295	1.80	2.20	465
240	1.00	0.85	188	1.00	1.30	295	1.60	1.90	465
277	0.85	0.72	188	0.85	1.10	295	1.40	1.70	465
347 ②	0.52	0.56	188	0.60	0.93	295	1.00	1.32	465
480	0.50	0.47	189	0.40	0.65	295	0.80	1.00	465

Quick Estimate Illumination Charts ①

How to use Quick-Estimate Illumination Chart

1. Refer to “Quick-Estimate Illumination Chart” for the lamp type and wattage to be used.
2. Determine “room size” of area to be lighted. “Small Room” is 232.2 m² (2500 ft²) or less. “Medium Room” is 232.2 m² (2500 ft²) thru 929.0 m² (10,000 ft²). A “Large Room” is 929.0 m² (10,000 ft²) or more.
3. Find level of light (footcandles) required in vertical column of figures at left of chart. Then follow horizontal line (real or interpolated) to right until it intersects with “Arc” of selected “room size.” Come directly down from point of intersection to horizontal line of number “Square Feet Per Luminaire.” The resulting number (real or interpolated) is the “number of square feet” one Appleton Baymaster will illuminate to the selected average maintained footcandle level when mounted in conjunction with other units in the high bay installation.
4. Divide number of total square feet in project by “number of square feet per luminaire” to get number of units required.
5. Take square root of resulting “number of square feet per luminaire” number to determine spacing between units.

400 Watt High Pressure Sodium

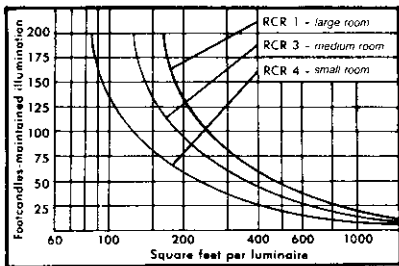

250 Watt High Pressure Sodium

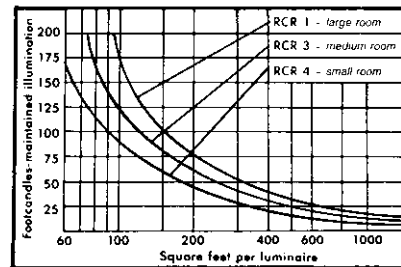

① Photometric charts available on request.

② Certified to meet the Canadian Electrical Code (CEC) only.

Baymaster™ Prismatic 250/400 High Bay Luminaires

150 W, 250 W, 400 W HPS.

NEC/CEC:

Listed for Ordinary (Unclassified) Locations

Photometric Data ①

Square Steel Poles for Davit Mount Luminaires

Distance (ft) Ahead/ Behind Footcandle	Mounting Height Feet			
	30	40	50	60
165	—	—	.01	.02
160	—	—	.01	.03
155	—	—	.01	.03
150	—	—	.02	.04
145	—	—	.02	.04
140	—	.01	.03	.06
135	—	.01	.03	.09
130	—	.01	.04	.14
125	—	.02	.05	.20
120	—	.03	.06	.27
115	—	.04	.10	.35
110	.01	.05	.17	.46
105	.01	.06	.26	.60
100	.02	.08	.38	.77
95	.03	.10	.54	.93
90	.05	.21	.74	1.13
85	.07	.37	1.00	1.37
80	.10	.60	1.29	1.66
75	.14	.91	1.62	2.02
70	.23	1.35	2.05	2.16
65	.55	1.91	2.69	2.21
60	1.06	2.53	3.07	2.21
55	1.85	3.39	3.17	2.18
50	3.08	4.55	3.19	2.34
45	4.51	4.93	3.16	2.24
40	6.64	4.98	3.23	2.31
35	8.65	4.98	3.18	2.57
30	8.85	5.04	3.63	2.85
25	8.95	5.49	4.10	3.16
20	9.25	6.41	4.64	3.43
15	11.4	7.47	4.95	3.41
10	13.7	7.67	4.83	3.18
5	12.7	6.53	3.93	2.60
0	6.58	3.70	2.37	1.65
-5	1.15	.81	.58	.48
-10	.60	.40	.33	.29
-15	.77	.31	.23	.18
-20	1.13	.43	.21	.15
-25	1.11	.59	.26	.15
-30	.85	.70	.35	.19

Typical Footcandle Values

400 Watt High Pressure Sodium

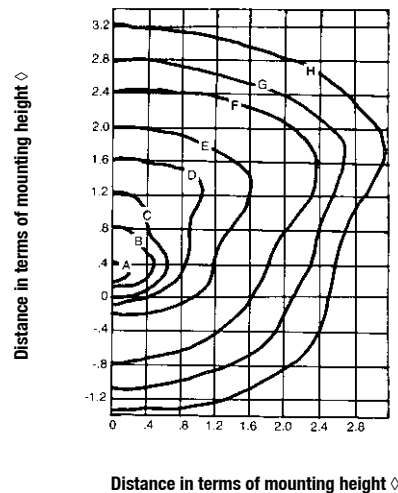

400 W HPS Mtg. Ht.	Ft. Candles for Iso-Footcandle Lines							
	A	B	C	D	E	F	G	H
20	29.03	20.21	19.19	8.07	2.39	.39	.17	.04
25	18.58	12.91	12.28	5.16	1.53	.25	.11	.04
30	12.90	8.98	8.53	3.59	1.06	.17	.08	.03
35	9.48	6.60	6.27	2.63	.78	.13	.06	.02
40	7.26	5.05	4.80	2.02	.60	.10	.04	.02
45	5.73	4.00	3.79	1.59	.47	.08	.03	.01

This report has been prepared in accordance with IES guides on testing procedures. It is representative of luminaires tested under standardized and stabilized laboratory conditions. Various operating factors can cause differences between laboratory data and actual field performance.

① Additional photometric charts available on request.

② Distance in terms of mounting height (i.e., ratio) of distance to height. Example: @ 4.6 m (15 ft) mounting height, 1 means 4.6 m (15 ft); 2 means 9.1 m (30 ft), etc.

Super-Baymaster™ High Bay Luminaires

High Bay Luminaires for Mill Duty and Corrosive Atmospheres

150 W, 175 W, 250 W, 400 W or 1000 W HPS; 1000 W PSMH; 1000 W MH.

CEC:

Listed for Ordinary (Unclassified) Locations

Applications

- For illumination of mills (pulp and paper), manufacturing, storage and other areas where corrosion, moisture or dust present severe problems.
- CSA approved weatherproof (Encl. 3) with open reflector and dust-tight (Encl. 3 and 5) with enclosing lens.
- Will operate safely in temperatures ranging from -40 °C to +65 °C (-40 °F to +149 °F) ambient.

Features

- Corrosion resistant. All external surfaces of the ballast housing are coated with a heavy-duty epoxy-finish providing durability and resistant to both alkali and acidic atmospheric conditions. To suit specific atmospheric requirements, consult the factory for a suitable finish.
- High efficiency reflectors (up to 76% with 1000 W MH lamps) and exceptionally long HID lamp life make Super-Baymaster luminaires unusually economical to own and operate.
- The Baymaster reflector is a unique design that combines high efficiency with low glare in a compact size.
- Super-Baymaster luminaires are furnished with open reflectors. For enclosed reflectors, clear or prismatic glass are available.
- Pre-wired with high temperature fixture wire, these integral ballasted luminaires are supplied with dual-tap primary for 120 or 240 Volt lines or with 208, 277 or 347 Volt primary. Ballasts are highest quality, Class H insulated, CWA and CWI types, thermally isolated for cooler operating and long life. Grounding wire provided.
- To protect the internal components of the luminaire from corrosive atmospheres all mating surfaces are gasketed.
- Mogul base socket with spring loaded center contact and heavy gauge, screw shell with double lamp grips to prevent lamps from loosening due to vibration.
- Installation is quick and easy:
 - (1) lift ballast assembly onto the hanger hub and rotate 60° until sealed on hub
 - (2) tighten locking nut (hand tight) to secure ballast assembly
 - (3) make supply connections (90° wire) and replace wiring cover
 - (4) snap reflector in place
 - (5) install lamp

Standard Materials

- Reflector: aluminum
- Sockets: porcelain

Standard Finishes

- Screws: nickel plated brass
- Housing: epoxy powder coated external surfaces

Options

- Quartz auxiliary: units are available with a pre-wired sensor circuit for automatically lighting a quartz auxiliary lamp when power dip or lamp failure extinguishes the main HID lamp.
- Fuse kits: for grounded systems.
- Lenses: clear or prismatic glass with heavy-duty, stainless steel clips to secure lens to reflector.
- HPS units available with a pulse eliminator which effectively shuts down the ballast assembly when lamp fails.
- Optional finishes may be ordered to suit specific environments in regular or specific colors.



Shown with optional lens: 1000 W

Dimensions in Millimeters (Inches)

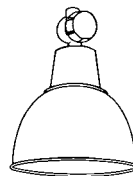

Height

530.4 mm (20-7/8"); 150-400 W HPS
500.1 mm (19-11/16"); 1000 W HPS, PSMH, MH

Width

406.4 mm (16"); 150-400 W HPS
508.0 mm (20"); 1000 W HPS, PSMH, MH

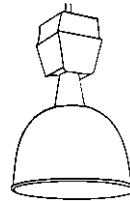

Height

736.6 mm (29"); 150-400 W HPS
787.4 mm (31"); 1000 W HPS, PSMH, MH

Width

406.4 mm (16"); 150-400 W HPS
508.0 mm (20"); 1000 W HPS, PSMH, MH

CEC Certifications and Compliances

- CSA Certified: 009349
- CSA Standard: C22.2 No. 250.0

Related Products

- For power hook, fusing and other suspension accessories, see *Fixture Hanger Accessories* page.

Super-Baymaster™ High Bay Luminaires

High Bay Luminaires for Mill Duty and Corrosive Atmospheres

150 W, 175 W, 250 W, 400 W or 1000 W HPS; 1000 W PSMH; 1000 W MH.

CEC:

Listed for Ordinary (Unclassified) Locations

Order using catalog numbering guide below or select catalog number from tables on following pages.

Catalog Numbering Guide for GSB and GSS

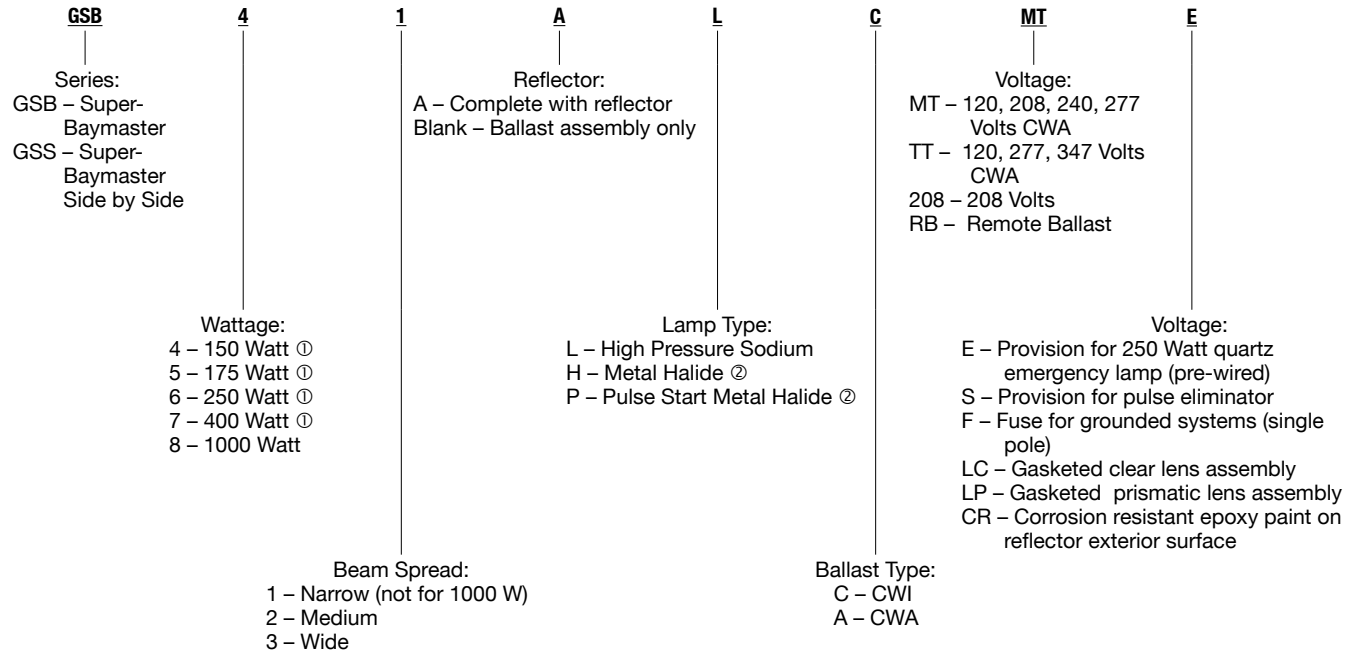

Accessories and Replacement Parts

	Description	Catalog Number
Wire Guard	With relamp door. Zinc plated	G-HB20-G
Safety Chain	Secures ballast and reflector	G-HB-7000-SC
Wiring Kit	Supplied with 0.91 meters (3 feet) of 600 Volt +90 °C (+194 °F) 3-conductor no. 16 SOW cable and 19.1 mm (3/4") FHHM hook (shipped separately) Add Suffix:	PWK
Sockets	Socket for Metal Halide	SPF-1004
	Socket for High Pressure Sodium	SPF-1001

① Only available in high pressure sodium.

② Only available in 1000 Watt.

Super-Baymaster™ High Bay Luminaires

High Bay Luminaires for Mill Duty and Corrosive Atmospheres

150 W, 175 W, 250 W, 400 W or 1000 W HPS; 1000 W PSMH; 1000 W MH.

CEC:
Listed for Ordinary (Unclassified) Locations

Appleton®

HID/AREA: NECC/CEC ORDINARY LOCATION HIGH BAY

Luminaire Performance — High Pressure Sodium

Distribution ①	150 Watt		175 Watt		250 Watt		400 Watt		1000 Watt	
	Efficiency	Spacing to Mounting Height	Efficiency	Spacing to Mounting Height	Efficiency	Spacing to Mounting Height	Efficiency	Spacing to Mounting Height	Efficiency	Spacing to Mounting Height
Narrow	66.3%	0.5:1	66.3%	0.5:1	68.9%	0.5:1	66.4%	0.5:1	—	—
Medium	71.3%	1.1:1	71.3%	1.1:1	74.4%	1.7:1	71.4%	1.1:1	71.3%	0.7:1
Wide	73.3%	2.0:1	73.3%	2.0:1	78.0%	2.0:1	73.5%	2.0:1	74.4%	1.4:1

Luminaire Performance — Metal Halide

Distribution ①	1000 Watt	
	Efficiency	Spacing to Mounting Height
Narrow	—	—
Medium	76.2%	1.1:1
Wide	75.4%	2.5:1

Quick Estimate Illumination Charts ②

How to use Quick-Estimate Illumination Chart

1. Refer to “Quick-Estimate Illumination Chart” for the lamp type and wattage to be used.
2. Determine “room size” of area to be lighted. “Small Room” is 232.2 m² (2500 ft²) or less. “Medium Room” is 232.2 m² (2500 ft²) thru 929.0 m² (10,000 ft²). A “Large Room” is 929.0 m² (10,000 ft²) or more.
3. Find level of light (footcandles) required in vertical column of figures at left of chart. Then follow horizontal line (real or interpolated) to right until it intersects with “Arc” of selected “room size.” Come directly down from point of intersection to horizontal line of number “Square Feet Per Luminaire.” The resulting number (real or interpolated) is the “number of square feet” one Appleton Baymaster will illuminate to the selected average maintained footcandle level when mounted in conjunction with other units in the high bay installation.
4. Divide number of total square feet in project by “number of square feet per luminaire” to get number of units required.
5. Take square root of resulting “number of square feet per luminaire” number to determine spacing between units.

1000 Watt High Pressure Sodium

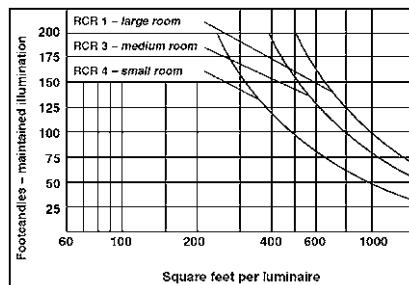

1000 Watt Metal Halide

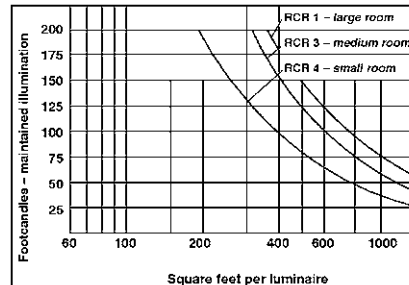

① Reflector adjusts for narrow to medium to wide distribution without tools.

② Photometric charts available on request.

Wallmaster™ HPS/PSMH Luminaires

Vertical and Horizontal Wall Mount

50 W, 75 W, 100 W, 150 W HPS; 70 W, 100 W PSMH.

NEC/CEC:

Listed for Ordinary (Unclassified) Locations

Applications

- Totally enclosed luminaires for public security installations. Tough polycarbonate refractor provides vandal resistance.
- Ideal where illumination over wide areas adjacent to walls is required. Applications include walkways, parking lots and garages, building exteriors, shopping centers, stores, restaurants, tunnels, underpasses, loading docks, ramps, security lighting areas, entrances and recreational areas.

Features

- Computer designed optical system. Reflector provides optimum down and out light distribution. Prismatic refractor provides soft light with even distribution, reducing glare.
- Contemporary architectural design with attractive bronze polyester finish. Soft, diffused light enhances the beauty of any architectural setting.
- Enclosed and gasketed for use in wet locations—indoors and out. High temperature neoprene gasketing.
- Easy to maintain. Hinged lens frame swings open (just loosen two captive bolts) for fast, easy relamping and access to internal components.
- Quick, easy installation. Fixture bolts to any flat surface or any standard 76.2 or 101.6 mm (3" or 4") outlet box for vertical mounting.
- High energy efficiency. High pressure sodium lamps use approximately one-fourth as much electrical energy as incandescent lamps.
- Pre-wired, integrally ballasted.
- Complete assemblies available with a choice of ballasts: high reactance high power factor—with or without photocontrol (automatic ON-OFF operation). High power factor ballasts provide a minimum 90% P.F. and are suitable for use in high ambient temperature areas. High reactance high power factor ballasts are single-tap (120 or 480 Vac), dual tap (120/277 Vac) and multi-tap (120-277 Vac). Reactor and reactor high power factor ballasts are 120 Vac.
- Glass thermal barrier in 100 W and 150 W units protects polycarbonate lens from heat for longer lens life.
- Tough, molded polycarbonate refractor provides cool fixture operation.
- Three knockouts provided for conduit and wiring.
- Medium base porcelain socket with spring loaded nickel plated contacts.

Standard Materials

- Ballast housing and wall bracket: aluminum
- Hinged lens assembly: high Impact, non-solarizing, polycarbonate
- Reflector: aluminum

Standard Finishes

- Ballast housing, wall bracket: two-coat bronze polyester finish
- Reflector: natural finish

Options

- Photocontrol provides automatic ON-OFF operation. Order luminaires with **-PC** suffix or add **-PC** suffix to any 120 Volt luminaire catalog numbers.

Note: For multi-tap ballast specify voltage to be used.



Dimensions in Millimeters (Inches)

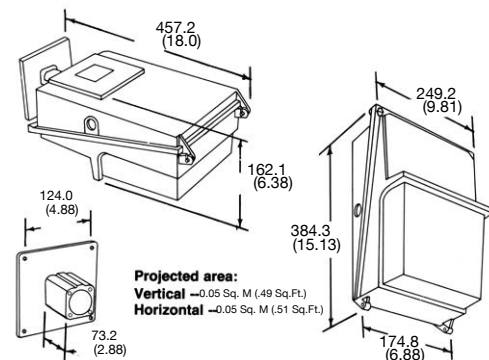

NEC/CEC Certifications and Compliances

- UL Standard: E85142
- UL Standard: 1598
- CSA Certified: LR9349

Wallmaster™ HPS/PSMH Luminaires

Vertical and Horizontal Wall Mount

50 W, 75 W, 100 W, 150 W HPS; 70 W, 100 W PSMH.

NEC/CEC:
Listed for Ordinary (Unclassified) Locations

Description	Line Voltage	Vertical Mount	Catalog Number	
			Horizontal Mount ③	Vertical Mount ④
50-Watt High Pressure Sodium				
Reactor Ballast ①	120 V	G-WM130L-12R	G-WM134L-12R	G-WMM50L-R1 ④
Reactor Ballast, High Power Factor ①	120 V	G-WM130L-12RH	G-WM134L-12RH	G-WMM50L-H1 ④
70-Watt High Pressure Sodium				
High Reactance Ballast, High Power Factor	120/208/240/277 V	G-WM230L-MT	G-WM234L-MT	G-WMM70L-MT ④②
High Reactance Ballast, High Power Factor	480 V	G-WM230L-48	G-WM234L-48	—
Reactor Ballast ①	120 V	G-WM230L-12R	G-WM234L-12R	G-WMM70L-R1 ④
Reactor Ballast, High Power Factor ①	120 V	G-WM230L-12RH	G-WM234L-12RH	G-WMM70L-H1 ④
100-Watt High Pressure Sodium				
High Reactance Ballast, High Power Factor	120/208/240/277 V	G-WM330L-MT	G-WM334L-MT	G-WMM10L-MT ④②
High Reactance Ballast, High Power Factor	480 V	G-WM330L-48	G-WM334L-48	—
Reactor Ballast ①	120 V	G-WM330L-12R	G-WM334L-12R	G-WMM10L-R1 ④
Reactor Ballast, High Power Factor ①	120 V	G-WM330L-12RH	G-WM334L-12RH	G-WMM10L-H1 ④
150-Watt High Pressure Sodium				
High Reactance Ballast, High Power Factor	120/208/240/277 V	G-WM430L-MT	G-WM434L-MT	—
High Reactance Ballast, High Power Factor	480 V	—	—	—
Reactor Ballast ①	120 V	G-WM430L-12R	G-WM434L-12R	G-WMM15L-R1 ④
Reactor Ballast, High Power Factor ①	120 V	G-WM430L-12RH	G-WM434L-12RH	G-WMM15L-H1 ④
70-Watt Pulse Start Metal Halide				
High Reactance Ballast, High Power Factor	120/208/240/277 V	G-WM230H-MT	G-WM234H-MT	G-WMM70H-MT ④②
100-Watt Pulse Start Metal Halide				
High Reactance Ballast, High Power Factor	120/208/240/277 V	G-WM330H-MT	G-WM334H-MT	G-WMM10H-MT ④②

Wall Mounting Kit

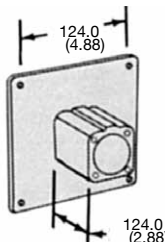
Dimensions	Description	Catalog Number
	Adapts vertical mount fixtures to horizontal position.	G-WM-HMK

① Add suffix **-PC** for Photocontrol. Provides automatic dusk-to-dawn ON-OFF operation. Specify voltage to be used with photocell, if used with multi voltage ballast.

② Change the **-MT** suffix to **-TT** for tri-tap 120/277/347 V.

③ Comes with Wall Mounting Kit GWMHMK

④ Vertical Mounting Wallmaster has CSA Certification only.

Wallmaster™ HPS/PSMH Luminaires

Vertical and Horizontal Wall Mount

50 W, 75 W, 100 W, 150 W HPS; 70 W, 100 W PSMH.

NEC/CEC:

Listed for Ordinary (Unclassified) Locations

Line Voltage	Type of Ballast	Starting Amps	Operating Amps	Total Watts
50-Watt High Pressure Sodium				
120	Reactor	1.80	1.18	60
120	Reactor, High Power Factor	0.75	0.55	60
70-Watt High Pressure Sodium				
120/208/240/277	High Reactance, High Power Factor	0.75/0.35	0.81/0.35	91
480	High Reactance, High Power Factor	0.21	0.21	94
120	Reactor	2.25	1.70	87
120	Reactor, High Power Factor	0.85	0.75	82
100-Watt High Pressure Sodium				
120/208/240/277	High Reactance, High Power Factor	1.30/.60	1.15/0.50	130
480	High Reactance, High Power Factor	0.33	0.31	135
120	Reactor	3.05	2.40	115
120	Reactor, High Power Factor	1.50	1.05	115
150-Watt High Pressure Sodium				
120/208/240/277	High Reactance, High Power Factor	2.00/0.85	1.65/.72	188
480	High Reactance, High Power Factor	0.50	0.47	189
120	Reactor	4.55	3.40	170
120	Reactor, High Power Factor	2.20	1.50	170
70-Watt Pulse Start Metal Halide				
120/208/240/277	High Reactance, High Power Factor	0.80/0.39	0.85/0.39	95
100-Watt Pulse Start Metal Halide				
120/208/240/277	Constant Wattage Auto transformer (CWA)	1.22/0.44	1.15/0.50	128

Wallmaster™ HPS/PSMH Luminaires

Vertical and Horizontal Wall Mount

50 W, 75 W, 100 W, 150 W HPS; 70 W, 100 W PSMH. Data Based on 70 Watt, HPS Clear B-17 Medium Base Lamp (6,300 lumens).

NEC/CEC:
Listed for Ordinary (Unclassified) Locations

Photometric Data ①

Ft. Candles for Iso-Footcandle Lines							
Mtg. Ht.	A	B	C	D	E	F	G
6'	5.80	4.80	3.87	2.88	1.94	0.96	0.39
7'	4.22	3.54	2.84	2.14	1.42	0.70	0.29
8'	3.26	2.72	2.17	1.63	1.09	0.54	0.22
10'	2.09	1.73	1.39	1.04	0.70	0.34	0.14
12'	1.45	1.21	0.96	0.72	0.48	0.24	0.10
14'	1.06	0.89	0.71	0.53	0.36	0.18	0.07

Watts	Lumens	Mult.
35	2,250	.357
50	3,500	.556
100	9,500	1.508
150	16,000	2.540

Typical Footcandle Values

70 W High Pressure Sodium

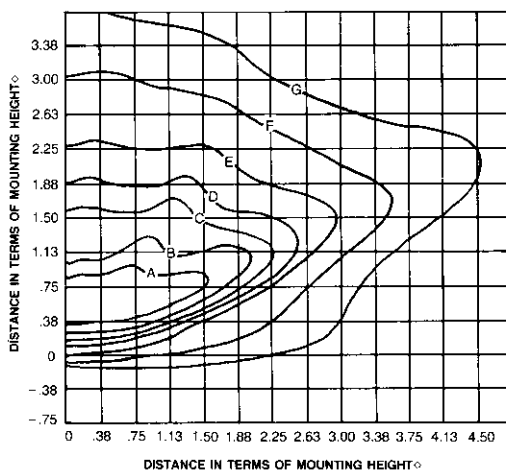

NOTE: For other HPS, Clear, Med. Base Lamps multiply all footcandle values as follows:

◇ Distance in terms of mounting height (i.e., ratio) of distance to height. Example: @ 4.6 m (15 ft) mounting height, 1 means 4.6 m (15 ft); 2 means 9.1 meters (30 ft), etc.)

① Additional photometric charts available on request.

Areamaster™ 250/400 Integrally Ballasted Floodlights

100 W to 400 W HID

For hazardous and marine locations.

NEC:

Class I, Division 2, Groups A, B, C, D
Class I, Zone 2, AEx nR, Groups IIA, IIB, IIC

CEC:

Class I, Division 2, Groups A, B, C, D
Class I, Zone 2, Ex nR, Groups IIA, IIB, IIC
Class II, Division 1 and 2, Groups E, F, G
Class III

NEC/CEC:

Wet locations
Marine outside type (salt water)
IP66

Applications

- Powerful, efficient weatherproof lighting for medium and large areas such as:
 - Pulp and paper mills
 - Processing plants
 - Chemical plants
 - Oil refineries
 - Foundries
 - Storage areas
 - Waste and sewage treatment
 - Parking garages
 - Other areas where dust, water, dirt and rough usage are a problem

Features

- Compact in size, attractively styled contemporary design, rugged and dependable.
- Easy to install and service.
- A wide range of ballasts and voltages are available for both domestic and export applications.
- Integral ballast.
- One-piece housing.
- One-piece lens cover. Secured by four 1/4" Dia. captive stainless steel slotted hex-head bolts.
- Thermal shock and impact resistant glass lens.
- Heavy duty, high temperature silicone rubber gasket, firmly seated.
- Heavy duty mogul-base porcelain socket with heavy gauge brass, nickel-plated, double lamp-grip screw shell and springloaded center contact.
- Compound parabolic, double segment, finished aluminum reflector for optimum efficiency.
- Mounting choice:
 - (1) Yoke mount, zinc plated steel yoke with architectural bronze polyester finish
 - (2) Pole mount, built-in slip-fitter, for internal wiring, adjustable laterally and vertically, slip fits 50.8 mm (2.00") thru 63.5 mm (2.50") pipe, architectural bronze polyester finish available for use in CEC governed locations
- Cool operating temperatures translate into long luminaire life.

Standard Materials

- Ballast housing and lens door: copperfree (4/10 of 1% max.) aluminum
- Gasket: silicone rubber
- Socket: heavy duty porcelain with heavy gauge brass shell
- Reflector: finished aluminum
- Yoke mount: zinc plated steel
- Bolts: stainless steel

Standard Finishes

- Ballast housing, lens cover, yoke and pole mount: architectural bronze polyester
- Socket: nickel-plated

Options

- For Division 2 rating, add suffix **I2**.
- For Ex nR/AEx nR version with terminal blocks, add suffix **-Z2**.
- For a fixture with terminal blocks, order the Ex nR/AEx nR version, add suffix **-Z2**.



Dimensions in Millimeters (Inches)

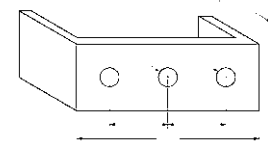
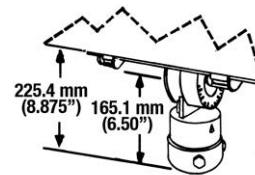
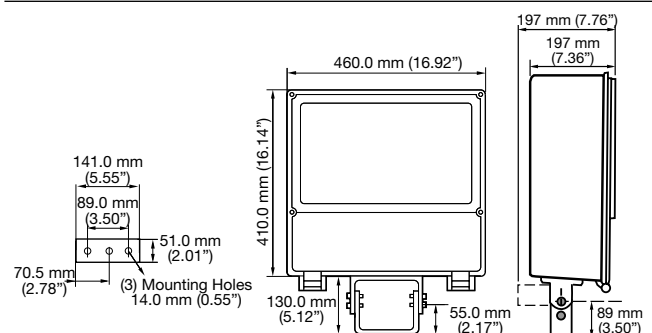

NEC/CEC Certifications and Compliances

- Areamaster 250/400
 - Wet locations
 - Marine outside type (salt water)
 - UL Standard: UL 1598, 1598A, 844
 - UL Listed: E10794
 - CSA Standards: C22.2 No. 25, C22.2 No. 94, C22.2 No. 97, C22.2 No. 137
 - CSA Approval: LR25248
- Zone 2 Areamaster 250/400
 - UL Standard: UL 1598, 1598A, 60079-0, 60079-15
 - UL Listed: E10794
 - CSA Standards: E79-0, E79-15
 - CSA Approval: LR25428
 - Index of Protection (solid and liquid): IP66

Areamaster™ 250/400 Integrally Ballasted Floodlights

100 W to 400 W HID

For hazardous and marine locations.

NEC:
Class I, Division 2, Groups A, B, C, D
Class I, Zone 2, AEx nR, Groups IIA, IIB, IIC

CEC:
Class I, Division 2, Groups A, B, C, D
Class I, Zone 2, Ex nR, Groups IIA, IIB, IIC
Class II, Division 1 and 2, Groups E, F, G
Class III

NEC/CEC:
Wet locations
Marine outside type (salt water)
IP66

Order using catalog numbering guide below or select catalog number from tables on following pages.

Catalog Numbering Guide For Areamaster 250/400 Floodlights

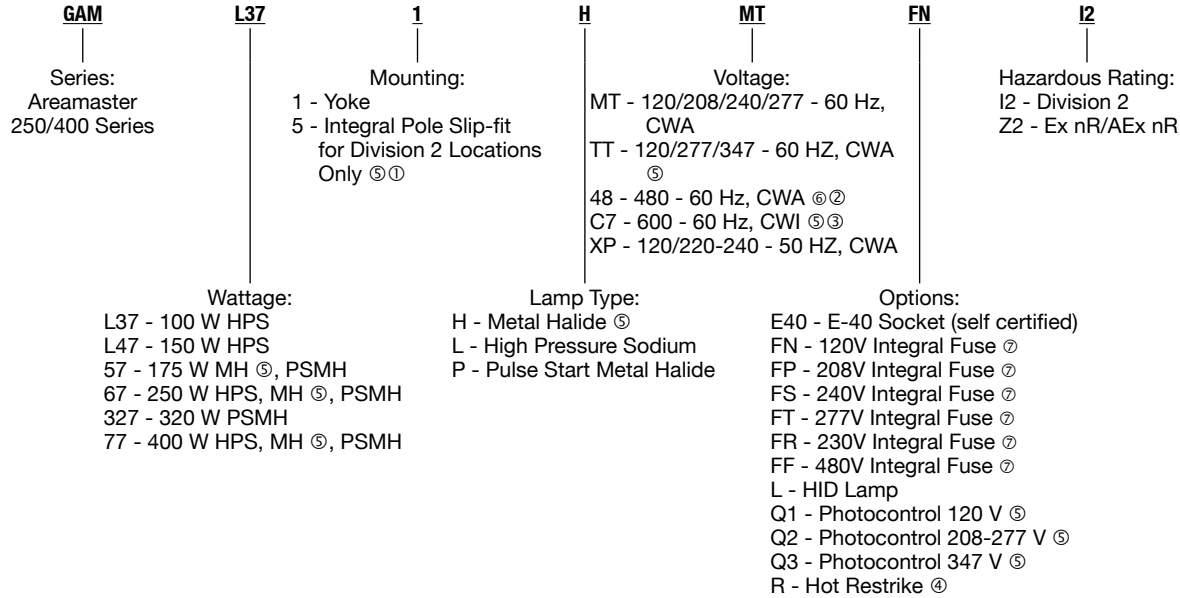

“T” Numbers Represent the Maximum Lamp Temperature for Class I, Division 2 Locations and Maximum Surface Temperature Under Dust Blanket for Class II, Division 1 Locations.

“T” Number	T1	350	325	T2	T2A	T2B	T2C	T2D	T3	T3A	T3B	T3C	T4	T4A	T5	T6
Temp. Range (°C)	351-450	326-350	301-325	281-300	261-280	231-260	216-230	201-215	181-200	166-180	161-165	136-160	121-135	101-120	86-100	85
Temp. Range (°F)	664-842	619-662	574-617	538-572	502-536	448-500	421-446	394-419	358-392	331-356	322-329	277-320	250-275	214-248	187-212	185

“T” Numbers Represent the Maximum Surface Temperature for Luminaires with AEx nA nR or AEx nR rating

“T” Number	T1	T2	T3	T4	T5	T6
Temp. Range (°C)	301-450	201-300	136-200	101-135	86-100	85
Temp. Range (°F)	547-842	394-572	277-392	214-275	187-212	185

- ① Slip-fit for 2" to 2-1/2" pole top tenons.
- ② For CEC 480 V, 60 Hz, consult factory.
- ③ Not available for PSMH versions.
- ④ For NEC, “Hot Restrike” option available for 100 W through 150 W HPS only. For CEC, “Hot Restrike” option available for up to 400 W.
- ⑤ Certified to meet the Canadian Electrical Code (CEC) only.
- ⑥ Certified to meet the National Electrical Code (NEC) only.
- ⑦ Optional fusing is available for use with NEC Rated products.



HID/FLOODLIGHT: NEC/CEC ENCLOSED AND GASKETED



Areamaster™ 250/400 Integrally Ballasted Floodlights

100 W to 400 W HID

For hazardous and marine locations.

NEC:
Class I, Division 2, Groups A, B, C, D
Class I, Zone 2, AEx nR, Groups IIA, IIB, IIC

CEC:
Class I, Division 2, Groups A, B, C, D
Class I, Zone 2, Ex nR, Groups IIA, IIB, IIC
Class II, Division 1 and 2, Groups E, F, G
Class III

NEC/CEC:
Wet locations
Marine outside type (salt water)
IP66

"T" Numbers

Watts	Lamp		Supply Wire Temp. °C (°F)	Ambient Temp. °C (°F)	NEC/CEC	CEC	NEC/CEC
	Type	Voltage			Class I, Division 2, Groups A, B, C, D	Class II, Division 1 and 2, Groups E, F, G	Class I, Zone 2
100	HPS	MT, TT, XP, 48, C7	75 (167)	40 (104)	T3	T3B	T5
			90 (194)	55 (131)	T2D	—	T4
			105 (221)	65 (149)	T2C	—	T4
150	HPS	MT, TT, XP, 48, C7	90 (194)	40 (104)	T2C	T3B	T4
			105 (221)	55 (131)	T2B	—	T4
			125 (257)	65 (149)	T2B	—	T3
250	HPS	MT, TT, XP, 48, C7	75 (167)	40 (104)	350 °C (662 °F)	T3B	T4
			90 (194)	55 (131)	350 °C (662 °F)	—	T3
			105 (221)	65 (149)	T1	—	T3
400	HPS	MT, TT, XP, 48, C7	105 (221)	40 (104)	T1	T3B	T3
			125 (257)	50 (122)	—	—	T3
			90 (194)	40 (104)	T2	T3B	T4
175	PSMH	MT, TT, 48	105 (221)	55 (131)	325 °C (617 °F)	—	T3
			125 (257)	65 (149)	325 °C (617 °F)	—	T3
			85 (185)	40 (104)	325 °C (617 °F)	T3B	T3
250	PSMH	MT, TT, 48	105 (221)	55 (131)	325 °C (617 °F)	—	T3
			110 (230)	65 (149)	—	—	T3
			90 (194)	40 (104)	325 °C (617 °F)	T3B	T3
320	PSMH	MT, TT, 48	105 (221)	55 (131)	325 °C (617 °F)	—	T3
			105 (221)	55 (131)	325 °C (617 °F)	—	T3
			105 (221)	40 (104)	325 °C (617 °F)	T3B	T3
400	PSMH	MT, TT, 48	125 (257)	55 (131)	325 °C (617 °F)	—	T3
			90 (194)	40 (104)	T2	120 °C (248 °F)	T4
			105 (221)	55 (131)	325 °C (617 °F)	120 °C (248 °F)	T3
175	MH ①	MT, TT, CT	110 (230)	65 (149)	325 °C (617 °F)	120 °C (248 °F)	T3
			85 (185)	40 (104)	325 °C (617 °F)	120 °C (248 °F)	T3
			105 (221)	55 (131)	350 °C (662 °F)	120 °C (248 °F)	T3
250	MH ①	MT, TT, CT	110 (230)	65 (149)	350 °C (662 °F)	120 °C (248 °F)	T3
			105 (221)	55 (131)	350 °C (662 °F)	120 °C (248 °F)	T3
			105 (221)	40 (104)	325 °C (617 °F)	120 °C (248 °F)	T3

HID/FLOODLIGHT: NEC/CEC ENCLOSED AND GASKETED

Appleton®

① Mercury vapor and metal halide luminaires are not available for purchase within the United States. Please check with your countries governing legislation regarding allowable lamp types before ordering.

Areamaster™ 250/400 Integrally Ballasted Floodlights

100 W to 400 W HID

For hazardous and marine locations.

NEC:
Class I, Division 2, Groups A, B, C, D
Class I, Zone 2, AEx nR, Groups IIA, IIB, IIC

CEC:
Class I, Division 2, Groups A, B, C, D
Class I, Zone 2, Ex nR, Groups IIA, IIB, IIC
Class II, Division 1 and 2, Groups E, F, G
Class III

NEC/CEC:
Wet locations
Marine outside type (salt water)
IP66

Lamp	Line Voltage	Weight kg (lb)	Volume dm ³ (in ³)	Catalog Number	
				Class 1, Division 2	Class I, Zone 2 Ex nR/AEx nR
High Pressure Sodium					
100 W HPS	120/208/240/277	12.9 (28.4)	62.5 (3814)	G-AML371L-MT-I/2	G-AML371L-MT-Z2
	120/220-240 V 50 Hz			G-AML371L-XP-I/2	G-AML371L-XP-Z2
	480			G-AML371L-48-I/2 ②	G-AML371L-48-Z2 ②
150 W HPS	120/208/240/277	12.9 (28.4)	62.5 (3814)	G-AML471L-MT-I/2	G-AML471L-MT-Z2
	120/220-240 V 50 Hz			G-AML471L-XP-I/2	G-AML471L-XP-Z2
	480			G-AML471L-48-I/2 ②	G-AML471L-48-Z2 ②
	120/277/347			G-AML471L-TT-I/2 ③	G-AML471L-TT-Z2 ③
	600 ①			G-AML471L-C7-I/2 ③	G-AML471L-C7-Z2 ③
250 W HPS	120/208/240/277	14.3 (31.5)	62.5 (3814)	G-AM671L-MT-I/2	G-AM671L-MT-Z2
	120/220-240 V 50 Hz			G-AM671L-XP-I/2	G-AM671L-XP-Z2
	480			G-AM671L-48-I/2 ②	G-AM671L-48-Z2 ②
	120/277/347			G-AM671L-TT-I/2 ③	G-AM671L-TT-Z2 ③
	600 ①			G-AM671L-C7-I/2 ③	G-AM671L-C7-Z2 ③
400 W HPS	120/208/240/277	16.0 (35.3)	62.5 (3814)	G-AM771L-MT-I/2	G-AM771L-MT-Z2
	120/220-240 V 50 Hz			G-AM771L-XP-I/2	G-AM771L-XP-Z2
	480			G-AM771L-48-I/2 ②	G-AM771L-48-Z2 ②
	120/277/347			G-AM771L-TT-I/2 ③	G-AM771L-TT-Z2 ③
	600 ①			G-AM771L-C7-I/2 ③	G-AM771L-C7-Z2 ③

HID/FLOODLIGHT: NEC/CEC ENCLOSED AND GASKETED

Appleton®

① Supplied complete with CWI Isolated Secondary Ballast for 600 Vac.
② Certified to meet the National Electrical Code (NEC) only.
③ Certified to meet the Canadian Electrical Code (CEC) only.

Areamaster™ 250/400 Integrally Ballasted Floodlights

100 W to 400 W HID

For hazardous and marine locations.

NEC:

Class I, Division 2, Groups A, B, C, D
Class I, Zone 2, AEx nR, Groups IIA, IIB, IIC

CEC:

Class I, Division 2, Groups A, B, C, D
Class I, Zone 2, Ex nR, Groups IIA, IIB, IIC
Class II, Division 1 and 2, Groups E, F, G
Class III

NEC/CEC:

Wet locations
Marine outside type (salt water)
IP66

Lamp	Line Voltage	Weight kg (lb)	Volume dm ³ (in ³)	Catalog Number	
				For Class 1, Division 2 Classified Duty and Marine Yoke Mount	Class I, Zone 2 Yoke Mounting
Pulse Start Metal Halide					
175 W PSMH	120/208/240/277	12.9 (28.4)	62.5 (3814)	G-AM571P-MT-I/2	G-AM571P-MT-Z2
	480			G-AM571P-48-I/2 ②	G-AM571P-48-Z2
	120/277/347			G-AM571P-TT-I/2 ③	G-AM571P-TT-Z2 ③
250 W PSMH	120/208/240/277	14.3 (31.5)	62.5 (3814)	G-AM671P-MT-I/2	G-AM671P-MT-Z2
	480			G-AM671P-48-I/2 ②	G-AM671P-48-Z2 ②
	120/277/347			G-AM671P-TT-I/2 ③	G-AM671P-TT-Z2
320 W PSMH	120/208/240/277	16.0 (35.3)	62.5 (3814)	G-AM3271P-MT-I/2	G-AM3271P-MT-Z2 ③
	480			G-AM3271P-48-I/2 ②	G-AM3271P-48-Z2 ②
	120/277/347			G-AM3271P-TT-I/2 ③	G-AM3271P-TT-Z2 ③
400 W PSMH	120/208/240/277	16.0 (35.3)	62.5 (3814)	G-AM771P-MT-I/2	G-AM771P-MT-Z2
	480			G-AM771P-48-I/2 ②	G-AM771P-48-Z2 ②
	120/277/347			G-AM771P-TT-I/2 ③	G-AM771P-TT-Z2 ③
Metal Halide ④					
175 W MH	120/277/347	12.9 (28.4)	62.5 (3814)	G-AM571H-TT-I/2 ③	G-AM571H-TT-Z2 ③
	120/220-240 V 50 Hz			G-AM571H-XP-I/2 ③	G-AM571H-XP-Z2 ③
	600 ①			G-AM571H-C7-I/2 ③	G-AM571H-C7-Z2 ③
250 W MH	120/277/347	14.3 (31.5)	62.5 (3814)	G-AM671H-TT-I/2 ③	G-AM671H-TT-Z2 ③
	120/220-240 V 50 Hz			G-AM671H-XP-I/2 ③	G-AM671H-XP-Z2 ③
	600 ①			G-AM671H-C7-I/2 ③	G-AM671H-C7-Z2 ③
400 W MH	120/277/347	16.0 (35.3)	62.5 (3814)	G-AM771H-TT-I/2 ③	G-AM771H-TT-Z2 ③
	120/220-240 V 50 Hz			G-AM771H-XP-I/2 ③	G-AM771H-XP-Z2 ③
	600 ①			G-AM771H-C7-I/2 ③	G-AM771H-C7-Z2 ③

① Supplied complete with CWI Isolated Secondary Ballast for 600 Vac.

② Certified to meet the National Electrical Code (NEC) only.

③ Certified to meet the Canadian Electrical Code (CEC) only.

④ Mercury vapor and metal halide luminaires are not available for purchase within the United States. Please check with your countries governing legislation regarding allowable lamp types before ordering.

Areamaster™ 250/400 Integrally Ballasted Floodlights





100 W to 400 W HID

For hazardous and marine locations.

NEC:
Class I, Division 2, Groups A, B, C, D
Class I, Zone 2, AEx nR, Groups IIA, IIB, IIC

CEC:
Class I, Division 2, Groups A, B, C, D
Class I, Zone 2, Ex nR, Groups IIA, IIB, IIC
Class II, Division 1 and 2, Groups E, F, G
Class III

NEC/CEC:
Wet locations
Marine outside type (salt water)
IP66

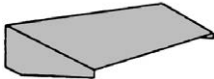
	Description	Catalog Numbers
<p>Crossarm Mounting Bracket</p> 	<p>Has 180° horizontal adjustment — degree marked. Facilitates mounting floodlight to crossarm or other flat surface, or to G-AM-8-WB. Includes floodlight yoke bolts. Malleable iron, zinc plated, chromate sealed, architectural bronze polyester finish.</p>	<p>G-AM-8-CA</p>
<p>Pipe or Wall Mount Bracket</p> 	<p>Used with G-AM-8-CA. Clamps to 1" to 2-1/2" pipe, vertical or horizontal, or mounts on flat surfaces. Includes U-bolt and crossarm bracket bolts. Malleable iron, zinc plated, chromate sealed, with architectural bronze polyester finish.</p>	<p>G-AM-8-WB</p>
<p>Poletop Slip-Fitter</p> 	<p>Slip-fits 1-1/2" or 2" pipe size poletop tenons. Includes floodlight yoke bolts, 3 locking bolts, and cord grip. Body is malleable iron-zinc plated, chromate sealed, with cast aluminum cap. Assembly has architectural bronze polyester finish.</p>	<p>G-SF20</p>
	<p>Slip-fits 2" or 2-1/2" poletop tenons. Includes floodlight yoke bolts, 3 locking bolts, and cord grip. Malleable iron, zinc plated, chromate sealed, with architectural bronze polyester finish.</p>	<p>G-AM-8-SF</p>
<p>Vandal Shield</p> 	<p>UV stabilized polycarbonate, with installation hardware and instructions.</p>	<p>G-AM-6-VS</p>
<p>Top Visor</p> 	<p>Easy to install with hardware supplied. Aluminum, with architectural bronze polyester finish.</p>	<p>G-AM-6-V</p>

HID/FLOODLIGHT: NEC/CEC ENCLOSED AND GASKETED

Appleton

Areamaster™ 250/400 Integrally Ballasted Floodlights

100 W to 400 W HID

For hazardous and marine locations.

NEC:

Class I, Division 2, Groups A, B, C, D
Class I, Zone 2, AEx nR, Groups IIA, IIB, IIC

CEC :

Class I, Division 2, Groups A, B, C, D
Class I, Zone 2, Ex nR, Groups IIA, IIB, IIC
Class II, Division 1 and 2, Groups E, F, G
Class III

NEC/CEC:

Wet locations
Marine outside type (salt water)
IP66

Line Voltage	Frequency	Type of Ballast	Starting Amps	Operating Amps	Total Watts
100 Watt High Pressure Sodium					
120	60	HX-HPF	1.30	1.15	130
208	60	HX-HPF	0.76	0.67	130
240	60	HX-HPF	0.66	0.60	130
277	60	HX-HPF	0.60	0.52	130
347	60	HX-HPF	0.45	0.39	130
480	60	HX-HPF	0.33	0.31	135
120	50	HX-HPF	0.90	1.20	130
220	50	HX-HPF	0.50	0.65	130
240	50	HX-HPF	0.45	0.60	130
150 Watt High Pressure Sodium					
120	60	HX-HPF	2.00	1.70	188
208	60	HX-HPF	1.15	0.95	188
240	60	HX-HPF	1.00	0.85	188
277	60	HX-HPF	0.85	0.72	188
347	60	HX-HPF	0.52	0.56	188
480	60	HX-HPF	0.50	0.47	189
120	50	HX-HPF	1.50	1.60	188
220	50	HX-HPF	0.85	0.90	188
240	50	HX-HPF	0.75	0.80	188
250 Watt High Pressure Sodium					
120	60	CWA	2.00	2.50	295
208	60	CWA	1.20	1.50	295
240	60	CWA	1.00	1.30	295
277	60	CWA	0.85	1.10	295
347	60	CWA	0.60	0.93	295
480	60	CWA	0.40	0.65	295
120	50	CWA	1.85	2.75	300
220	50	CWA			
240	50	CWA			
400 Watt High Pressure Sodium					
120	60	CWA	3.30	3.80	465
208	60	CWA	1.80	2.20	465
240	60	CWA	1.60	1.90	465
277	60	CWA	1.40	1.70	465
347	60	CWA	1.00	1.32	464
480	60	CWA	0.80	1.00	465
120	50	CWA	3.70	4.00	465
220	50	CWA			
240	50	CWA			
175 Watt Pulse Start Metal Halide					
120	60	Super CWA	0.90	1.78	199
208	60	Super CWA	0.50	1.08	199
240	60	Super CWA	0.35	0.89	199
277	60	Super CWA	0.30	0.76	199
347	60	Super CWA	0.25	0.65	208
480	60	Super CWA	0.25	0.50	213
250 Watt Pulse Start Metal Halide					
120	60	Super CWA	1.90	2.50	288
208	60	Super CWA	1.10	1.45	288
240	60	Super CWA	0.96	1.25	288
277	60	Super CWA	0.85	1.10	288
347	60	Super CWA	0.62	0.90	291
480	60	Super CWA	0.45	0.60	285
320 Watt Pulse Start Metal Halide					
120	60	Super CWA	2.60	3.25	368
208	60	Super CWA	1.50	1.90	368
240	60	Super CWA	1.30	1.65	368
277	60	Super CWA	1.15	1.40	368
347	60	Super CWA	0.70	1.10	368
480	60	Super CWA	0.60	0.80	368
400 Watt Pulse Start Metal Halide					
120	60	Super CWA	3.50	4.00	454
208	60	Super CWA	2.00	2.30	454
240	60	Super CWA	1.25	2.00	454
277	60	Super CWA	1.50	1.75	454
347	60	Super CWA	1.10	1.35	452
480	60	Super CWA	0.90	1.00	454
175 Watt Metal Halide ①					
120	60	CWA	1.30	1.80	213
208	60	CWA	0.75	1.10	213
240	60	CWA	0.65	0.90	213
277	60	CWA	0.55	0.80	213
347	60	CWA	0.50	0.65	210
480	60	CWA	0.35	0.45	213
120	50	CWA	1.70	1.90	210
220	50	CWA	0.80	1.10	210
240	50	CWA			
250 Watt Metal Halide ①					
120	60	CWA	1.20	2.60	295
208	60	CWA	0.65	1.50	295
240	60	CWA	0.60	1.30	295
277	60	CWA	0.50	1.12	295
347	60	CWA	0.80	0.90	295
480	60	CWA	0.30	0.65	298
120	50	CWA	2.00	2.50	285
220	50	CWA	0.94	1.30	285
240	50	CWA			
400 Watt Metal Halide ①					
120	60	CWA	3.25	4.00	458
208	60	CWA	1.90	2.30	458
240	60	CWA	1.65	2.00	458
277	60	CWA	1.40	1.75	458
347	60	CWA	1.20	1.40	460
480	60	CWA	0.85	1.00	462
120	50	CWA	2.70	4.10	480
220	50	CWA	1.50	2.20	480
240	50	CWA			

① Mercury vapor and metal halide luminaires are not available for purchase within the United States. Please check with your countries governing legislation regarding allowable lamp types before ordering.

Areamaster™ 250/400 Integrally Ballasted Floodlights

100 W to 400 W HID

For hazardous and marine locations.

NEC:
Class I, Division 2, Groups A, B, C, D
Class I, Zone 2, AEx nR, Groups IIA, IIB, IIC

CEC:
Class I, Division 2, Groups A, B, C, D
Class I, Zone 2, Ex nR, Groups IIA, IIB, IIC
Class II, Division 1 and 2, Groups E, F, G
Class III

NEC/CEC:
Wet locations
Marine outside type (salt water)
IP66

Photometric Data

Typical Footcandle Values ♦

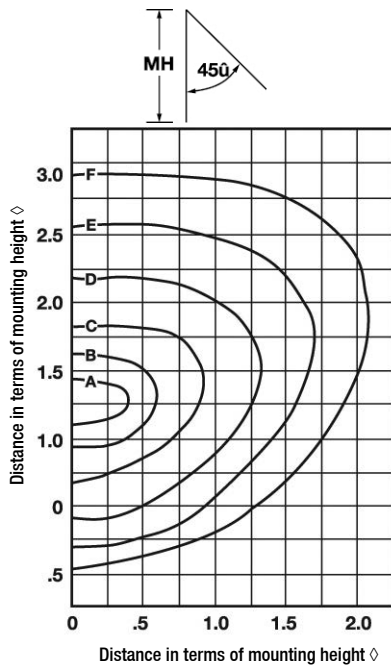

Mtg. Ht. Meters (feet)	Ft. Cdles for Iso-Footcandle Lines					
	A	B	C	D	E	F
400W HPS						
18.3 m (60')	3.27	2.74	1.82	0.92	0.37	0.18
15.2 m (50')	4.74	4.00	2.90	1.37	0.52	0.27
12.2 m (40')	7.65	6.28	4.38	2.27	0.82	0.43
9.1 m (30')	13.10	10.92	7.83	3.47	1.45	0.77
6.1 m (20')	28.22	25.55	17.37	7.28	3.46	1.82

400W MH ①						
18.3 m (60')	2.32	1.66	1.00	0.58	0.33	0.17
15.2 m (50')	3.32	2.32	1.49	0.76	0.48	0.25
12.2 m (40')	5.48	3.62	2.32	1.33	0.75	0.36
9.1 m (30')	9.79	7.80	3.98	2.16	1.33	0.68
6.1 m (20')	17.26	14.60	9.30	5.31	3.15	1.49

For 400W PSMH multiply FC values by 1.29; for 320W PSMH use 0.97.

400W PSMH						
18.3 m (60')	2.60	1.86	1.12	0.65	0.37	0.19
15.2 m (50')	3.72	2.60	1.66	0.85	0.54	0.28
12.2 m (40')	6.14	4.05	2.60	1.49	0.84	0.40
9.1 m (30')	10.96	8.74	4.46	2.42	1.49	0.76
6.1 m (20')	19.33	16.35	10.41	5.94	3.53	1.67

Mtg. Ht. Meters (feet)	Ft. Cdles for Iso-Footcandle Lines					
	A	B	C	D	E	F
250W HPS						
18.3 m (60')	1.96	1.64	1.09	0.55	0.22	0.11
15.2 m (50')	2.84	2.40	1.74	0.82	0.31	0.16
12.2 m (40')	4.58	3.76	2.62	1.36	0.49	0.26
9.1 m (30')	7.85	6.54	4.69	2.08	0.87	0.46
6.1 m (20')	16.90	15.30	10.40	4.36	2.07	1.09

250W MH ①						
18.3 m (60')	1.40	1.00	0.60	0.35	0.20	0.10
15.2 m (50')	2.00	1.40	0.90	0.46	0.29	0.15
12.2 m (40')	3.30	2.18	1.40	0.80	0.45	0.22
9.1 m (30')	5.90	4.70	2.40	1.30	0.80	0.41
6.1 m (20')	10.40	8.80	5.60	3.20	1.90	0.90

For 175W MH lamps, multiply FC values by 0.68. For 175W PSMH Lamps 0.85; for 200W PSMH use 1.03; for 250W PSMH use 1.22.

250W PSMH						
18.3 m (60')	1.90	1.63	0.82	0.48	0.27	0.14
15.2 m (50')	2.72	1.90	1.22	0.63	0.39	0.20
12.2 m (40')	4.48	2.96	1.90	1.09	0.61	0.30
9.1 m (30')	8.00	6.40	3.26	1.76	1.09	0.55
6.1 m (20')	14.40	11.97	7.61	4.35	2.58	1.22

For 175W MH lamps, multiply FC values by 0.68. For 175W PSMH Lamps 0.85; for 200W PSMH use 1.03; for 250W PSMH use 1.22.

♦ i.e., ratio of distance to height. Example: @ 6.1 meter (20 foot) mounting height, 1 means 6.1 meter (20 foot); 2 means 12.2 meter (40 foot), etc.

♦ Photometric charts available on request.

① Mercury vapor and metal halide luminaires are not available for purchase within the United States. Please check with your countries governing legislation regarding allowable lamp types before ordering.

Areamaster™ 1000 Floodlights

Integrally Ballasted. 1000 W HID

For hazardous locations.

NEC/CEC:

Listed for ordinary and marine locations

NEC – Optional hazardous locations:
Class I, Division 2, Groups A, B, C, D

CEC – Optional hazardous locations:
Class I, Division 2, Groups A, B, C, D
Class I, Zone 2, Ex nR, Groups IIA, IIB, IIC

Applications

- Powerful, efficient weatherproof lighting for large areas such as:
 - Pulp and paper mills
 - Processing plants
 - Chemical plants
 - Oil refineries
 - Foundries
 - Storage areas
 - Waste and sewage treatment
 - Parking garages
 - Other areas where dust, water, dirt and rough usage are a problem

Features

- Highly efficient, integrally ballasted floodlight. Has compact, lightweight, yet rugged diecast aluminum construction. Combines architecturally beautiful design with rugged dependability, simple installation and maintenance.
- Easy to install and service.
- A wide range of ballasts and voltages are available for both domestic and export applications.
- Integral ballast.
- One-piece housing.
- One-piece lens cover. Secured by five 1/4" Dia. captive stainless steel slotted hex-head bolts.
- Thermal shock and impact resistant glass lens.
- Heavy duty, high temperature silicone rubber gasket, firmly seated.
- Heavy duty mogul-base porcelain socket with heavy gauge brass, nickel-plated, double lamp-grip screw shell and spring-loaded center contact.
- Compound parabolic, double segment, finished aluminum reflector for optimum efficiency.
- Yoke mount, zinc plated steel yoke with architectural bronze polyester finish.
- 3/4" NPT tapped hub for power entry.

Standard Materials

- Ballast housing and lens door: copperfree (4/10 of 1% max.) aluminum
- Gasket: silicone rubber
- Socket: heavy duty porcelain with heavy gauge brass shell
- Reflector: finished aluminum
- Yoke mount: zinc plated steel
- Bolts: stainless steel

Standard Finishes

- Ballast housing, lens cover, yoke and pole mount: architectural bronze polyester
- Socket: nickel-plated

NEC/CEC Certifications and Compliances

- UL Standard: UL 1598, UL 844
- UL Listed: E10794



Yoke

Projected Area: 3.36 Sq. Ft.

HID/FLOODLIGHT: NEC/CEC ENCLOSED AND GASKETED

Appleton®

Areamaster™ 1000 Floodlights

Integrally Ballasted. 1000 W HID

For hazardous locations.

NEC/CEC:
Listed for ordinary and marine locations

NEC – Optional hazardous locations:
Class I, Division 2, Groups A, B, C, D

CEC – Optional hazardous locations:
Class I, Division 2, Groups A, B, C, D
Class I, Zone 2, Ex nR, Groups II

Order using catalog numbering guide below or select catalog number from tables on following pages.

Catalog Numbering Guide For Areamaster 1000 Floodlights

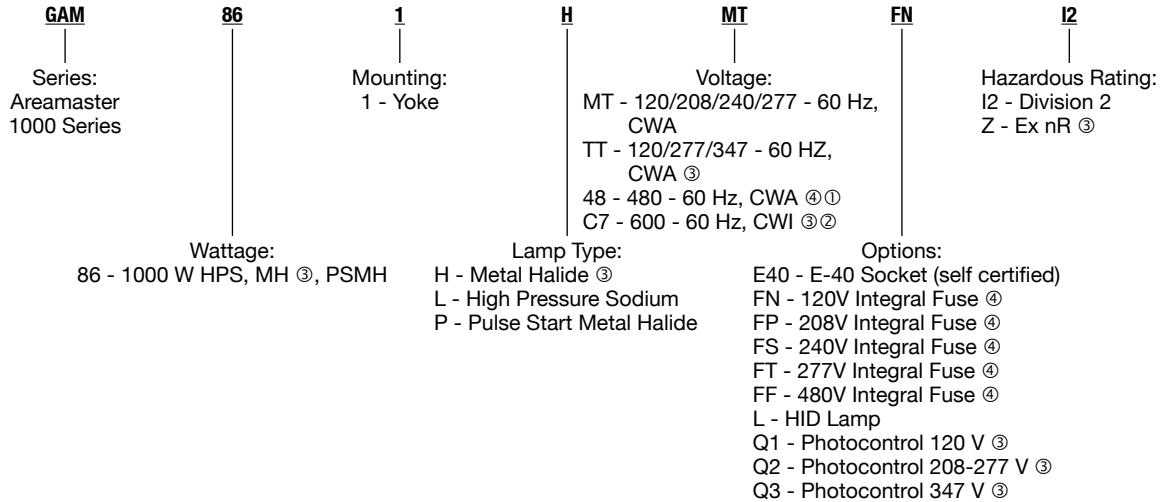

“T” Numbers Represent the Maximum Lamp Temperature for Class I, Division 2 Locations and Maximum Surface Temperature Under Dust Blanket for Class II, Division 1 Locations.

“T” Number	T1	350	325	T2	T2A	T2B	T2C	T2D	T3	T3A	T3B	T3C	T4	T4A	T5	T6
Temp. Range (°C)	351-450	326-350	301-325	281-300	261-280	231-260	216-230	201-215	181-200	166-180	161-165	136-160	121-135	101-120	86-100	85
Temp. Range (°F)	664-842	619-662	574-617	538-572	502-536	448-500	421-446	394-419	358-392	331-356	322-329	277-320	250-275	214-248	187-212	185

“T” Numbers Represent the Maximum Surface Temperature for Luminaires with AEx nA nR or AEx nR rating

“T” Number	T1	T2	T3	T4	T5	T6
Temp. Range (°C)	301-450	201-300	136-200	101-135	86-100	85
Temp. Range (°F)	547-842	394-572	277-392	214-275	187-212	185

① For CEC 480 V, 60 Hz, consult factory.

② Not for available for PSMH versions.

③ Certified to meet the Canadian Electrical Code (CEC) only.

④ Certified to meet the National Electrical Code (NEC) only.

Areamaster™ 1000 Floodlights

Integrally Ballasted. 1000 W HID

For hazardous locations.

NEC/CEC:
Listed for ordinary and marine locations

NEC – Optional hazardous locations:
Class I, Division 2, Groups A, B, C, D

CEC – Optional hazardous locations:
Class I, Division 2, Groups A, B, C, D
Class I, Zone 2, Ex nR, Groups II

Lamp Watts	Line Voltage	Weight kg (lb)	Volume dm ³ (in ³)	NEC/CEC Class 1, Division 2 Catalog Number	CEC Class I, Zone 2, Ex nR Catalog Number
High Pressure Sodium					
1000	120/208/240/277			G-AM861L-MT-I/2	G-AM861L-MT-Z ②
1000	120/277/347			G-AM861L-TT-I/2 ②	G-AM861L-TT-Z ②
1000	480	29.48 (65.0)	75.7 (4620)	G-AM861L-48-I/2	G-AM861L-48-Z ②
1000	600 ①			G-AM861L-C7-I/2 ②	G-AM861L-C7-Z ②
Metal Halide					
1000	120/208/240/277			G-AM861H-MT-I/2	G-AM861H-MT-Z ②
1000	120/277/347			G-AM861H-TT-I/2 ②	G-AM861H-TT-Z ②
1000	480	29.48 (65.0)	75.7 (4620)	G-AM861H-48-I/2	G-AM861H-48-Z ②
1000	600 ①			G-AM861H-C7-I/2 ②	G-AM861H-C7-Z ②
Pulse Start Metal Halide					
1000	120/208/240/277			G-AM861P-MT-I/2 ③	—
1000	480	29.48 (65.0)	75.7 (4620)	G-AM861P-48-I/2 ③	—

Dimensions in Millimeters (Inches)

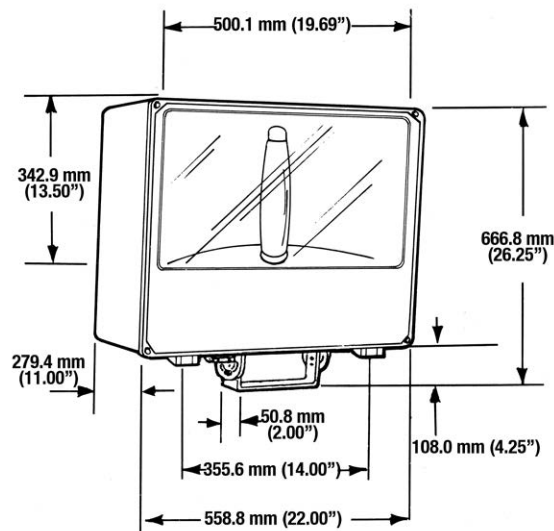

- ① Supplied complete with CWI Isolated Secondary Ballast for 600 Vac.
- ② Certified to meet the Canadian Electrical Code (CEC) only.
- ③ Certified to meet the National Electrical Code (NEC) only.

Areamaster™ 1000 Floodlights

Integrally Ballasted. 1000 W HID

For hazardous locations.







NEC/CEC:
Listed for ordinary and marine locations

NEC – Optional hazardous locations:
Class I, Division 2, Groups A, B, C, D

CEC – Optional hazardous locations:
Class I, Division 2, Groups A, B, C, D
Class I, Zone 2, Ex nR, Groups II

HID/FLOODLIGHT: NEC/CEC ENCLOSED AND GASKETED

Appleton®

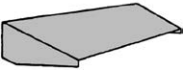
	Description	Catalog Numbers
Crossarm Mounting Bracket 	Has 180° horizontal adjustment — degree marked. Facilitates mounting floodlight to crossarm or other flat surface, or to G-AM-8-WB. Includes floodlight yoke bolts. Malleable iron, zinc plated, chromate sealed, architectural bronze polyester finish.	G-AM-8-CA
Pipe or Wall Mount Bracket 	Used with G-AM-8-CA. Clamps to 1" to 2-1/2" pipe, vertical or horizontal, or mounts on flat surfaces. Includes U-bolt and crossarm bracket bolts. Malleable iron, zinc plated, chromate sealed, with architectural bronze polyester finish.	G-AM-8-WB
Poletop Slip-Fitter 	Slip-fits 1-1/2" or 2" pipe size poletop tenons. Includes floodlight yoke bolts, 3 locking bolts, and cord grip. Body is malleable iron-zinc plated, chromate sealed, with cast aluminum cap. Assembly has architectural bronze polyester finish.	G-SF20
	Slip-fits 2" or 2-1/2" poletop tenons. Includes floodlight yoke bolts, 3 locking bolts, and cord grip. Malleable iron, zinc plated, chromate sealed, with architectural bronze polyester finish.	G-AM-8-SF
Locking-Type Photocontrol Receptacle 	For NEMA type photocontrol, with installation hardware and instructions.	G-1PCR
Vandal Shield 	UV stabilized polycarbonate, with installation hardware and instructions.	G-AM-8-NVS
Top Visor 	Easy to install with hardware supplied. Aluminum, with architectural bronze polyester finish.	G-AM-6-NV

Areamaster™ 1000 Floodlights

Integrally Ballasted. 1000 W HID

For hazardous locations.

NEC/CEC:
Listed for ordinary and marine locations

NEC – Optional hazardous locations:
Class I, Division 2, Groups A, B, C, D

CEC – Optional hazardous locations:
Class I, Division 2, Groups A, B, C, D
Class I, Zone 2, Ex nR, Groups II

Photometric Data

Typical Footcandle Values ①

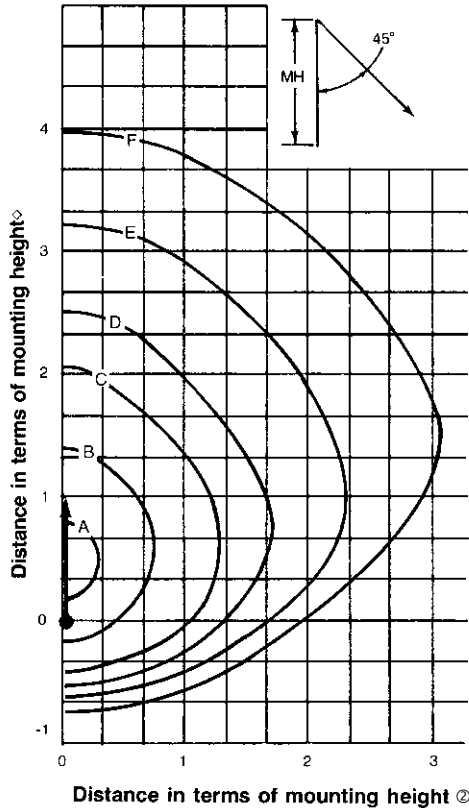

Mtg. Ht. M (Ft)	Footcandle Values for Iso Footcandle Lines					
	A	B	C	D	E	F
1000W HPS Clear, 140,000 Lumens, Cat. No. G-AM861L-MT						
18.3 (60)	8.0	3.0	1.0	0.5	0.20	0.10
15.2 (50)	11.5	4.6	1.5	0.72	0.27	0.15
12.2 (40)	17.3	6.8	2.4	1.0	0.45	0.21
9.1 (30)	31.5	12	4.1	1.9	0.80	0.30
1000W MH Clear, 110,000 Lumens, Cat. No. G-AM861H-MT						
18.3 (60)	6.0	3	1.0	0.5	0.20	0.10
15.2 (50)	8.2	4.2	1.4	0.8	0.28	0.15
12.2 (40)	12.6	7.9	2.3	1.2	0.42	0.19
9.1 (30)	23.0	11.6	4.0	2.1	0.70	0.25

① Photometric charts available on request.

② i.e., ratio of distance to height. Example: @ 6.1 meters (20 feet) mounting height, 1 means 6.1 meters (20 feet); 2 means 12.2 meters (40 feet), etc.

③ Certified to meet the Canadian Electrical Code (CEC) only.

Photometric Data ①

	HPS	MH	PSMH
Horiz. Spread	134°	133°	
Vert. Spread	131°	124°	
Beam Lumens	77,440	62,112	
Beam Effic.	55.3%	56.5%	
Max. CP	40,251	45,909	
Avg. Max. CP	38,396	38,490	
Total Lumens	80,846	66,008	
Total Effic.	57.7%	60.0%	

Electrical Specifications

Lamp Type	Line Voltage	Type of Ballast	Starting Amps	Operating Amps	Total Watts
1000 Watt High Pressure Sodium					
HPS	120	CWA	6.35	9.50	1100
HPS	208	CWA	3.80	5.50	1100
HPS	240	CWA	3.20	4.25	1100
HPS	277	CWA	2.75	4.20	1100
HPS	347	CWA	2.20	3.30	1100
HPS	480	CWA	1.80	2.45	1100
1000 Watt Metal Halide					
MH	120	CWA	8.00	9.20	1080
MH	208	CWA	4.60	5.30	1080
MH	240	CWA	4.00	4.60	1080
MH	277	CWA	3.50	4.00	1080
MH	347	CWA	2.50	3.20	1080
MH	480	CWA	2.00	2.30	1080
1000 Watt Pulse Start					
PSMH	120	Super CWA	7.00	9.00	1080
PSMH	208	Super CWA	4.00	5.30	1080
PSMH	240	Super CWA	3.50	4.50	1080
PSMH	277	Super CWA	3.00	3.90	1080
PSMH	480	Super CWA	N/A	N/A	1080

T Numbers and Temperature Ratings Areamaster 1000

Fixture Wattage	Fixture Type	T Ratings	Ambient Temp. °C (°F)	T Rating Temperature Range °C (°F)
1000	Class I Div 2	350	40 (104)	301-325 (574-617)
1000 ③	Ex nR IIC	T3	40 (104)	136-200 (277-392)

Areamaster™ Stainless Steel Floodlights

Integral Ballast. 250 W, 400 W HPS or PSMH. Mogul Base

For Marine; Class I, Division 2 Hazardous Locations; Class I, Zone 2; and Corrosive Environments.

NEC/CEC:
Class I, Division 2, Groups A, B, C, D
Class I, Zone 2 IIC
NEMA 4X
Marine Outside Type (Salt Water)
Wet Location

CEC:
Class II, Groups E, F, G
Class III

Applications

- Powerful, efficient weatherproof lighting for medium and large areas such as chemical plants, refineries, shipboard and marine industrial process areas where severely corrosive agents are present.

Features

- Compact in size, rugged and dependable.
- Easy to install and service.
- A wide range of ballasts and voltages are available for both domestic and export applications.
- Integral ballast.
- Completely assembled fixture saves installation time and cost.
- Easily removable ballast tray.
- Hinged door.
- Seamless welded construction.
- Can be mounted in any position ranging from lens down to horizontal, lens up.
- Stainless steel latches to allow relamping without tools.
- 3/4" NPT conduit/cable entry.

Standard Materials

- Fixture body and trunnion arm: 316 stainless steel
- 16 gauge 316 stainless steel
- Lens: thermal-shock-resistant and tempered impact-resistant glass
- Gasket: heavy-duty, high-temperature silicone rubber, firmly seated
- Socket: heavy-duty, mogul base porcelain with heavy gauge brass, nickel-plated, double lamp-grip screw shell and spring-loaded center contact
- Reflector: compound parabolic, double segment, finished aluminum for optimum efficiency



NEC/CEC Certifications and Compliances

- UL Standard: UL 1598, UL 1598A, UL 844
- UL Listed: E10794
- CSA Standards: C22.2 No. 94, C22.2 No. 137, C22.2 No. 250
- CSA Approval: LR25248

Order using catalog numbering guide below or select catalog number from tables on following pages.

Catalog Numbering Guide For Areamaster Stainless Steel Floodlights

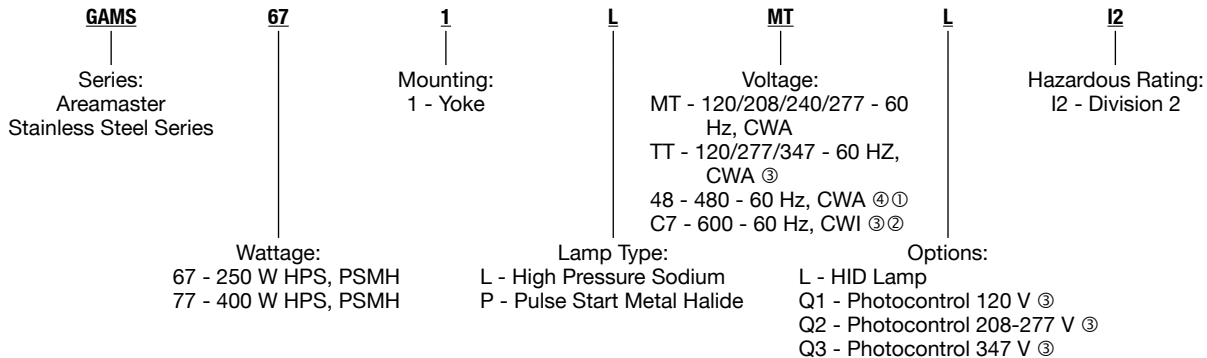

① For CEC 480 V, 60 Hz, consult factory.

② Available in High Pressure Sodium only.

③ Certified to meet the Canadian Electrical Code (CEC) only.

④ Certified to meet the National Electrical Code (NEC) only.

Areamaster™ Stainless Steel Floodlights

Integral Ballast. 250 W, 400 W HPS or PSMH. Mogul Base





For Marine; Class I, Division 2 Hazardous Locations; Class I, Zone 2; and Corrosive Environments.

NEC/CEC:
Class I, Division 2, Groups A, B, C, D
Class I, Zone 2 IIC
NEMA 4X
Marine Outside Type (Salt Water)
Wet Location

CEC:
Class II, Groups E, F, G
Class III

Lamp Type	Line Voltage	T Rating	Weight kg (lb)	Volume dm ³ (in ³)	Catalog Number
High Pressure Sodium					
400 W HPS	120/208/240/277	350	20.41 (45)	33.1 (2020)	GAMS771L-MT-I2
	120/277/347				GAMS771L-TT-I2 ①
	480				GAMS771L-48-I2 ②
	600				GAMS771L-C7-I2 ①
250 W HPS	120/208/240/277	350	20.41 (45)	33.1 (2020)	GAMS671L-MT-I2
	120/277/347				GAMS671L-TT-I2 ①
	480				GAMS671L-48-I2 ②
	600				GAMS671L-C7-I2 ①
Pulse Start Metal Halide					
400 W PSMH	120/208/240/277	450	20.41 (45)	33.1 (2020)	GAMS771P-MT-I2
	120/277/347				GAMS771P-TT-I2 ①
	480				GAMS771P-48-I2 ②
250 W PSMH	120/208/240/277	350	20.41 (45)	33.1 (2020)	GAMS671P-MT-I2
	120/277/347				GAMS671P-TT-I2 ①
	480				GAMS671P-48-I2 ②

Mounting Fittings and Accessories

	Description	Catalog Number
	Crossarm Mounting Bracket — Has 180° horizontal adjustment—degree-marked. Facilitates mounting floodlight to crossarm or other flat surface, or to G-AM-8-WB. Includes floodlight yoke bolts. Malleable iron, zinc plated, chromate sealed, architectural bronze polyester finish.	G-AM-8-CA
	Pipe or Wall Mount Bracket — Used with G-AM-8-CA. Clamps to 1" to 2-1/2" pipe, vertical or horizontal, or mounts on flat surfaces. Includes U-bolt and crossarm bracket bolts. Malleable iron, zinc plated, chromate sealed, with architectural bronze polyester finish.	G-AM-8-WB
	Poletop Slip-Fitter — 1-1/2" or 2" pipe size poletop tenons. Includes floodlight yoke bolt, 3 locking bolts, and cord grip. Body is malleable iron—zinc plated, chromate sealed, with cast aluminum cap. Assembly has architectural bronze polyester finish.	G-SF20
	Poletop Slip-Fitter — Slip-Fits 2" or 2-1/2" poletop tenons. Includes floodlight yoke bolts, 3 locking bolts and cord grip. Malleable iron, zinc plated, chromate sealed, with architectural bronze polyester finish.	G-AM-8-SF

① Certified to meet the Canadian Electrical Code (CEC) only.

② Certified to meet the National Electrical Code (NEC) only.

Areamaster™ Stainless Steel Floodlights

Integral Ballast. 250 W, 400 W HPS or PSMH. Mogul Base

For Marine; Class I, Division 2 Hazardous Locations; Class I, Zone 2; and Corrosive Environments.

NEC/CEC:
 Class I, Division 2, Groups A, B, C, D
 Class I, Zone 2 IIC
 NEMA 4X
 Marine Outside Type (Salt Water)
 Wet Location

CEC:
 Class II, Groups E, F, G
 Class III

Dimensions in Millimeters (Inches)

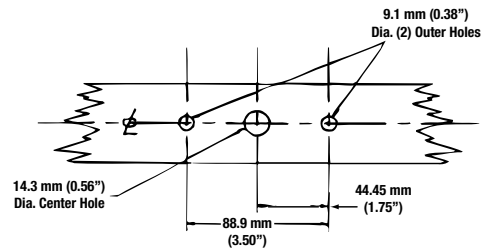
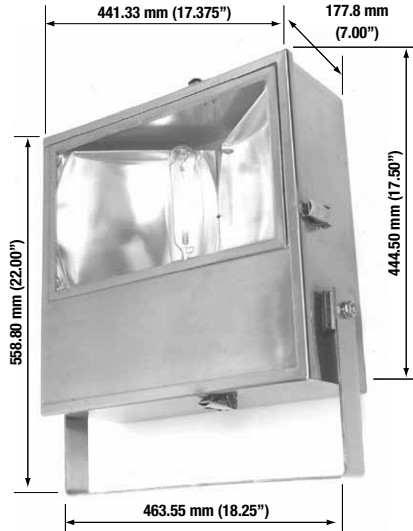

Trunnion Mount

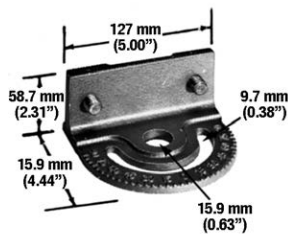

Crossarm Mounting Bracket



Pipe or Wall Mount Bracket



Poletop Slip-Fitter



Poletop Slip-Fitter

HID/FLOODLIGHT: NEC/CEC ENCLOSED AND GASKETED

Appleton®

Areamaster™ Stainless Steel Floodlights

Integral Ballast. 250 W, 400 W HPS or PSMH. Mogul Base

For Marine; Class I, Division 2 Hazardous Locations; Class I, Zone 2; and Corrosive Environments.

NEC/CEC:
 Class I, Division 2, Groups A, B, C, D
 Class I, Zone 2 IIC
 NEMA 4X
 Marine Outside Type (Salt Water)
 Wet Location

CEC:
 Class II, Groups E, F, G
 Class III

Photometric Data

Typical Footcandle Values ①

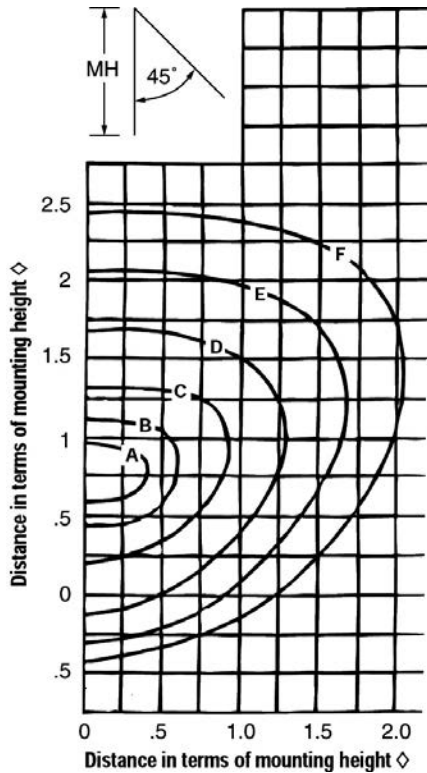

Electrical Specifications — All ballasts are CWA type

Line Voltage	Starting Amps	Operating Amps	Total Watts
400 W High Pressure Sodium			
120	3.30	3.80	465
208	1.80	2.20	465
240	1.60	1.90	465
277	1.40	1.70	465
347	1.00	1.32	464
480	0.80	1.00	465
400 W Pulse Start Metal Halide			
120	3.50	4.00	454
208	2.00	2.30	454
240	1.25	2.00	454
277	1.50	1.75	454
347	1.10	1.35	452
480	0.90	1.00	454
250 W High Pressure Sodium			
120	2.00	2.50	295
208	1.20	1.50	295
240	1.00	1.30	295
277	0.85	1.10	295
347	0.60	0.93	295
480	0.40	0.65	295
250 W Pulse Start Metal Halide			
120	1.90	2.50	288
208	1.10	1.45	288
240	0.96	1.25	288
277	0.85	1.10	288
347	0.62	0.90	291
480	0.45	0.60	285

Mtg. Ht. m (ft)	Footcandles for Iso-Footcandle Lines											
	A	B	C	D	E	F	A	B	C	D	E	F
	400 W HPS						250 W HPS					
18.3 (60)	3.27	2.74	1.82	0.92	0.37	0.18	1.96	1.64	1.09	0.55	0.22	0.11
15.2 (50)	4.74	4.00	2.90	1.37	0.52	0.27	2.84	2.40	1.74	0.82	0.31	0.16
12.2 (40)	7.65	6.28	4.38	2.27	0.82	0.43	4.58	3.76	2.62	1.36	0.49	0.26
9.1 (30)	13.10	10.92	7.83	3.47	1.45	0.77	7.85	6.54	4.69	2.08	0.87	0.46
6.1 (20)	28.22	25.55	17.37	7.28	3.46	1.82	16.90	15.30	10.40	4.36	2.07	1.09
	400 W PSMH						250 W PSMH					
18.3 (60)	2.60	1.86	1.12	0.65	0.37	0.19	1.90	1.36	0.82	0.48	0.27	0.14
15.2 (50)	3.72	2.60	1.66	0.85	0.54	0.28	2.72	1.90	1.22	0.63	0.39	0.20
12.2 (40)	6.14	4.05	2.60	1.49	0.84	0.40	4.48	2.96	1.90	1.09	0.61	0.30
9.1 (30)	10.96	8.74	4.46	2.42	1.49	0.76	8.00	6.40	3.26	1.76	1.09	0.55
6.1 (20)	19.33	16.35	10.41	5.94	3.53	1.67	14.40	11.97	7.61	4.35	2.58	1.22

① Photometric charts available on request.

◇ i.e., ratio of distance to height. Example: @ 6.1 m (20') mounting height, 1 means 6.1 m (20'); 2 means 12.2 m (40'), etc.

Wallmaster™ I/2 for Hazardous and Wet Locations

Class I, Division 2/Zone 2.

Enclosed and Gasketed. Integrally Ballasted. 70 W, 100 W, 150 W HPS

NEC/CEC:

Class I, Division 2, Groups A, B, C, D
Class I, Zone 2, Groups IIA, IIB, IIC

Applications

- Wall mounted luminaire suitable for outdoor applications.
- Areas where flammable gases are present under conditions defined by NEC Class I, Division 2 and Class I, Zone 2.

Features

- Attractive yet rugged design.
- Side hinged door allows unobstructed access to lamp and wiring components.
- Built in stop limits door opening to 90° and protects the lens from breakage.
- Latch mechanism: unique heavy-duty stainless steel latch secures the cover assembly while allowing the luminaire to be relamped without the use of tools.
- Prismatic tempered glass lens is thermal-shock- and impact-resistant giving a soft diffused light.
- Installation is fast and easy.
- Luminaire is furnished with two plugged 1/2" conduit entries.
- Mogul base socket is heavy-duty porcelain with heavy gauge brass nickel plated double lamp grip screw shell and spring loaded center contacts.
- Aluminum reflector is designed for maximum efficiency.
- Standard finish is architectural bronze tone baked epoxy.



NEC/CEC Certifications and Compliances

- UL Standard: UL 1598, UL 844
- cCSAus Certified: 025428
- CSA Standard: C22.2 No. 250, C22.2 No. 137
- CSA Certified: 025428

Order using catalog numbering guide below.

Catalog Numbering Guide For Wallmaster I/2 Luminaires

GWM	70	L	MT	H	R
Series: GWM - Wallmaster	Wattage: 70 - 70 W HPS 10 - 100 W HPS 15 - 150 W HPS 36 - Two 18 W PL-T 52 - Two 26 W PL-T 64 - Two 32 W PL-T	Lamp Type: L - High Pressure Sodium F - Fluorescent 48 - 480 MT - 120/208/240/277 BU - 120-277, 50/60 Hz (Fluorescent Only) TT - 120/277/347	Voltage:	Ratings: H - Hazardous Location	Options: E - Quartz Auxiliary Light (Non-Hazardous HID only) G - Wire Guard Q - Hazardous Photocontrol 120 to 277 Vac (Class I, Div. 2) R - HRE (Hot Restrike for HID only) S - PE (Safety Starter for HID only) T - Tamper proof Latch V - Polycarbonate Vandal Shield

HID/FLOODLIGHT: NEC/CEC HAZARDOUS ARCHITECTURAL

Appleton®

Wallmaster™ I/2 for Hazardous and Wet Locations

Class I, Division 2/Zone 2.

Enclosed and Gasketed. Integrally Ballasted. 70 W, 100 W, 150 W HPS

NEC/CEC:

Class I, Division 2, Groups A, B, C, D
Class I, Zone 2, Groups IIA, IIB, IIC

“T” Numbers for Wallmaster I/2 Fixtures

Lamp Watts	Lamp Type	Supply Wire °C (°F)	Maximum Ambient Temperature °C (°F)	Class I, Division 2 Class I, Zone 2
70	HPS	125 (257)	40 (104)	T2D
100	HPS	125 (257)	25 (77)	T2C
150	HPS	125 (257)	25 (77)	T2A
36	Fluorescent	125 (257)	40 (104) 55 (131)	T3
52	Fluorescent	125 (257)	40 (104) 55 (131)	T3
64	Fluorescent	125 (257)	40 (104) 55 (131)	T3

“T” Numbers Represent the Maximum Lamp Temperature for Class I, Division 2 Locations

“T” Number	T1	350	325	T2	T2A	T2B	T2C	T2D	T3	T3A	T3B	T3C	T4	T4A	T5	T6
Temp. Range (°C)	351-450	326-350	301-325	281-300	261-280	231-260	216-230	201-215	181-200	166-180	161-165	136-160	121-135	101-120	86-100	85
Temp. Range (°F)	664-842	619-662	574-617	538-572	502-536	448-500	421-446	394-419	358-392	331-356	322-329	277-320	250-275	214-248	187-212	185

Accessories

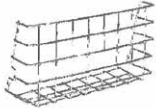
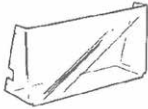
	Description	Catalog Number
	Guard - Stainless steel plated	G-WMWG
	Vandal Shield - UV stabilized polycarbonate. Can be used with guard.	G-WM-LS
	Clear Replacement Lens	G-WM-L

Dimensions in Millimeters (Inches)

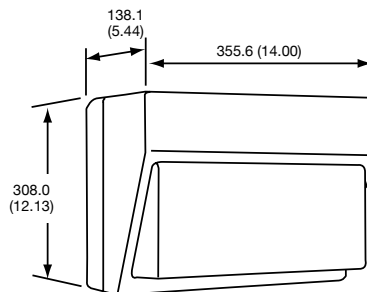

Code•Master™ 2 HID Factory Sealed Floodlights

Marine (Outside Type). Explosionproof

Integrally Ballasted. 150 W, 250 W, 400 W HPS; 150 W, 175 W, 250 W, 320 W, 350 W, 400 W PSMH; 175 W, 250 W, 400 W MH. Mogul Base.

NEC:

Class 1, Division 1 and 2, Groups C, D
Marine Type Electric Fixtures
Outside Type (Salt Water)

CEC:

Class I, Division 1 and 2, Groups B, C, D
Class II, Division 1, Groups E, F, G
Class II, Division 2, Groups F, G
Class III
CSA 4X

Applications

- UL Listed for Marine Type Electric Fixtures Outside Type (Salt Water).
- Ideal in Class I, Division 1 and 2 installations in refineries, in pipeline transportation facilities, at drilling rigs and in production facilities on land and marine platforms.
- Class I, Division 1 areas include:
 - (1) enclosed derricks, mud tanks, desander-desilter, gas-operated control devices, oil-gas separation vessels, shale shakers and flowing or beam wells
 - (2) flowing or beam wells in open areas with cellar or below grade sump
 - (3) on refinery docks where tankers are loaded with hoses or loading arms
 - (4) in compressor buildings (open or enclosed) where methane gas is present
- Virtually all enclosed areas at drilling operations or refineries where ventilation is inadequate, or where a cellar or below grade sump exists, are Class I, Division 1.

Features

- Choice of mountings: (1) crossarm with degree indicator; (2) junction box for horizontal or vertical mount; and (3) swivel for pole mount (screws onto standard 2" pipe threads).
- Fixtures operate safely in high ambient temperatures. For example, in Class I areas the 150 W HPS unit operateSee page 1290 for classified area suitability.
- Arrangement of heat-producing components results in more efficient heat dissipation for cooler fixture operation.
- All threaded joints are flame-tight.
- Five threads are always fully engaged in an explosionproof manner.
- Factory sealed. External seals not required.
- Strategic location of lamp socket, in combination with the interior prism design of the glass globe, provides optimum light distribution and control.
- Heat- and impact-resistant globes have smooth dust-resistant exterior.
- Superior corrosion resistance, with epoxy powder coat finish.
- Ballasts operate at low temperatures – PSMH: -29 °C (-20 °F); HPS: -40 °C (-40 °F).

Standard Materials

- Ballast housing, guard and junction box, and pole mounts: copperfree (4/10 of 1% max.) aluminum
- Crossarm mount: malleable iron
- Trunnion: steel.
- High bay reflector: aluminum
- Standard dome, deep dome and 30° angle reflectors: fiberglass reinforced polyester
- Socket: porcelain
- Screw shell: nickel-plated phosphor bronze

Standard Finishes

- Ballast housing, guard, trunnion and mounting accessories: epoxy-clad finish. Powder coat baked finish, electrostatically applied for complete, uniform corrosion protection



Shown with Optional High Bay Reflector

Effective Protected area: 1.8 Square Feet

Options

- Fuses for field installation are ordered by catalog number from the fuse kit table
- Quartz Auxiliary Emergency Lamp for PSMH and HPS fixtures. Relay switch installed fixture. Add suffix **-E** to fixture catalog number.
- Hot Restrike Option available for 150 W HPS. Add suffix **-R**.
- Smart Starter. Add suffix **-S**

NEC/CEC Certifications and Compliances

- UL Standard: UL 1598, UL 844
- UL Listed: E10794
- CSA Standard: C22.2 No. 250, C22.2 No. 137
- CSA Certified: 025428

Code•Master™ 2 HID Factory Sealed Floodlights

Marine (Outside Type). Explosionproof

Integrally Ballasted. 150 W, 250 W, 400 W HPS; 150 W, 175 W, 250 W, 320 W, 350 W, 400 W PSMH; 175 W, 250 W, 400 W MH. Mogul Base.

NEC:

Class 1, Division 1 and 2, Groups C, D
 Marine Type Electric Fixtures
 Outside Type (Salt Water)

CEC:

Class I, Division 1 and 2, Groups B, C, D
 Class II, Division 1, Groups E, F, G
 Class II, Division 2, Groups F, G
 Class III
 CSA 4X

Classified Area Suitability — Suitability includes use of reflector

Lamp Type	Lamp Watts	Supply Wire °C (°F)	Ambient Temp °C (°F)	Class I, Division 1 and 2 With Globe or with Globe and Reflector UL/NEC/CEC Temp. Ident. No.			Class II, Division 1 and 2 With Globe or with Globe and Reflector CEC Temp. Ident. No.	
				Nameplate Marking	NEC Groups	CEC Groups	Nameplate Marking	CEC Groups
High Pressure Sodium	150	50 (122)	40 (104)	T5	C,D	B, C, D	T3A	E,F
	150	75 (167)	55 (131)	—	C,D	B, C, D	T3	—
	250	75 (167)	40 (104)	T4	C,D	B, C, D	—	—
	250	75 (167)	55 (131)	—	C,D	B, C, D	—	—
	400	85 (185)	40 (104)	T3A	C,D	B, C, D	—	—
Pulse Start Metal Halide	175	75 (167)	40 (104)	T3B	C,D	B, C, D	T3C	E,F,G
	250	75 (167)	40 (104)	T3B	C,D	B, C, D	T3A	E,F
	320	75 (167)	40 (104)	T3	C,D	B, C, D	—	—
	350	75 (167)	40 (104)	T3	C,D	B, C, D	—	—
	400	75 (167)	40 (104)	T3	C,D	B, C, D	—	—
Metal Halide ①	175	75 (167)	40 (104)	T4	—	B, C, D	T3C	E, F, G
	250	75 (167)	40 (104)	T4	—	B, C, D	T3A	E, F
	400	75 (167)	40 (104)	T3C	—	B, C, D	—	—

① Mercury vapor and metal halide luminaires are not available for purchase within the United States. Please check with your countries governing legislation regarding allowable lamp types before ordering.

Code•Master™ 2 HID Factory Sealed Floodlights





Marine (Outside Type). Explosionproof

Integrally Ballasted. 150 W, 250 W, 400 W HPS; 150 W, 175 W, 250 W, 320 W, 350 W, 400 W PSMH. Mogul Base.

NEC:
Class 1, Division 1 and 2, Groups C, D
Marine Type Electric Fixtures
Outside Type (Salt Water)

Appleton

HID/FLOODLIGHT: NEC/CEC EXPLOSIONPROOF

	Lamp Watts	ANSI Lamp Type		Catalog Number ①③	
		HPS	PSMH	HPS	PSMH
Fixture Unit					
Furnished with Trunnion 3/4" hub. (3/4 – 14 NPT)					
	150	S55	M102	CFL150MT	CFP150MT
	175	—	M137/M152	—	CFP175MT
	250	S50	M138/M153	CFL250MT	CFP250MT
	320	—	M145	—	CFP320MT
	350	—	M131	—	CFP350MT
	400	S51	M135/M155	CFL400MT	CFP400MT
Fixture Unit with Junction Box for Horizontal or Vertical Mounting ②					
3/4" fixture hub and two conduit openings (3/4 – 14 NPT). 30" Flexible Coupling connects to 3/4" fixture hub and to 1/2" junction box opening. Furnished with one 3/4" Close-up Plug. Has Locking Screw for horizontal adjustment.					
	150	S55	M102	CFL150JBMT	CFP150JBMT
	175	—	M137/M152	—	CFP175JBMT
	250	S50	M138/M153	CFL250JBMT	CFP250JBMT
	320	—	M145	—	CFP320JBMT
	350	—	M131	—	CFP350JBMT
	400	S51	M135/M155	CFL400JBMT	CFP400JBMT
Fixture Unit with Pole-Top Mount (on 2" Threaded Pipe) ②					
2" tapered threads (2 – 11-1/2 NPT). Locking Screw for horizontal adjustment. 30" Flexible Coupling connects to 3/4" fixture hub (3/4 – 14 NPT) and to 1/2" pole-top opening (1/2-14 NPT).					
	150	S55	M102	CFL150SFMT	CFP150SFMT
	175	—	M137/M152	—	CFP175SFMT
	250	S50	M138/M153	CFL250SFMT	CFP250SFMT
	320	—	M145	—	CFP320SFMT
	350	—	M131	—	CFP350SFMT
	400	S51	M135/M155	CFL400SFMT	CFP400SFMT
Fixture Unit with Crossarm Mounting ②					
For mounting to flat surface. 180° horizontal adjustment with degree indicator. 30" Flexible Coupling connects to 3/4" fixture hub (3/4 – 14 NPT) and to any 1/2" opening (1/2 – 14 NPT).					
	150	S55	M102	CFL150CAMT	CFP150CAMT
	175	—	M137/M152	—	CFP175CAMT
	250	S50	M138/M153	CFL250CAMT	CFP250CAMT
	320	—	M145	—	CFP320CAMT
	350	—	M131	—	CFP350CAMT
	400	S51	M135/M155	CFL400CAMT	CFP400CAMT

① To order fixture with guard, add suffix **-G** before voltage suffix.

② Fixtures furnished with trunnion and bolts, flexible coupling and fittings, and mounting accessory. The trunnion provides vertical adjustment and the mounting accessory provides horizontal adjustment.

③ Change suffix **-MT** (120/208/240/277 V) to **-480** for 480 V.





Code•Master™ 2 HID Factory Sealed Floodlights

Marine (Outside Type). Explosionproof

Integrally Ballasted. 150 W, 250 W, 400 W HPS; 150 W, 175 W, 250 W, 320 W, 350 W, 400 W PSMH; 175 W, 250 W, 400 W MH. Mogul Base.

CEC:

Class I, Division 1 and 2, Groups B, C, D
 Class II, Division 1, Groups E, F, G
 Class II, Division 2, Groups F, G
 Class III
 CSA 4X

Lamp Watts	HPS	ANSI Lamp Type			HPS	Catalog Number ①③	
		PSMH	MH	PSMH		MH	
Fixture Unit							
Furnished with Trunnion 3/4" hub. (3/4 – 14 NPT)							
	150	S55	M102	—	CFL150TTCN	CFP150TTCN	—
	175	—	M137/M152	M57/H39	—	CFP175TTCN	CFH175TTCN
	250	S50	M138/M153	M58/H37	CFL250TTCN	CFP250TTCN	CFH250TTCN
	320	—	M145	—	—	CFP320TTCN	—
	350	—	M131	—	—	CFP350TTCN	—
	400	S51	M135/M155	M59/H33	CFL400TTCN	CFP400TTCN	CFH400TTCN
Fixture Unit with Junction Box for Horizontal or Vertical Mounting ②							
3/4" fixture hub and two conduit openings (3/4 – 14 NPT). 30" Flexible Coupling connects to 3/4" fixture hub and to 1/2" junction box opening. Furnished with one 3/4" Close-up Plug. Has Locking Screw for horizontal adjustment.							
	150	S55	M102	—	CFL150JBTTCN	CFP150JBTTCN	—
	175	—	M137/M152	M57/H39	—	CFP175JBTTCN	CFH175JBTTCN
	250	S50	M138/M153	M58/H37	CFL250JBTTCN	CFP250JBTTCN	CFH250JBTTCN
	320	—	M145	—	—	CFP320JBTTCN	—
	350	—	M131	—	—	CFP350JBTTCN	—
	400	S51	M135/M155	M59/H33	CFL400JBTTCN	CFP400JBTTCN	CFH400JBTTCN
Fixture Unit with Pole-Top Mount (on 2" Threaded Pipe) ②							
2" tapered threads (2 – 11-1/2 NPT). Locking Screw for horizontal adjustment. 30" Flexible Coupling connects to 3/4" fixture hub (3/4 – 14 NPT) and to 1/2" pole-top opening (1/2-14 NPT).							
	150	S55	M102	—	CFL150SFTTCN	CFP150SFTTCN	—
	175	—	M137/M152	M57/H39	—	CFP175SFTTCN	CFH175SFTTCN
	250	S50	M138/M153	M58/H37	CFL250SFTTCN	CFP250SFTTCN	CFH250SFTTCN
	320	—	M145	—	—	CFP320SFTTCN	—
	350	—	M131	—	—	CFP350SFTTCN	—
	400	S51	M135/M155	M59/H33	CFL400SFTTCN	CFP400SFTTCN	CFH400SFTTCN
Fixture Unit with Crossarm Mounting ②							
For mounting to flat surface. 180° horizontal adjustment with degree indicator. 30" Flexible Coupling connects to 3/4" fixture hub (3/4 – 14 NPT) and to any 1/2" opening (1/2 – 14 NPT).							
	150	S55	M102	—	CFL150CATTN	CFP150CATTN	—
	175	—	M137/M152	M57/H39	—	CFP175CATTN	CFH175CATTN
	250	S50	M138/M153	M58/H37	CFL250CATTN	CFP250CATTN	CFH250CATTN
	320	—	M145	—	—	CFP320CATTN	—
	350	—	M131	—	—	CFP350CATTN	—
	400	S51	M135/M155	M59/H33	CFL400CATTN	CFP400CATTN	CFH400CATTN

① To order fixture with guard, add suffix **-G** before voltage suffix.

② Fixtures furnished with trunnion and bolts, flexible coupling and fittings, and mounting accessory. The trunnion provides vertical adjustment and the mounting accessory provides horizontal adjustment.

③ Change voltage suffix **-TT** (120/277/347 V) to **-MT** for 120/208/240/277 V, **-C2** for 208 V, **-C3** for 240 V, **-C6** for 480 V, or **-C7** for 600 V.







Code•Master™ 2 HID Factory Sealed Floodlights

Marine (Outside Type). Explosionproof

Integrally Ballasted. 150 W, 250 W, 400 W HPS; 150 W, 175 W, 250 W, 320 W, 350 W, 400 W PSMH; 175 W, 250 W, 400 W MH. Mogul Base.

NEC:
Class 1, Division 1 and 2, Groups C, D
Marine Type Electric Fixtures
Outside Type (Salt Water)

CEC:
Class I, Division 1 and 2, Groups B, C, D
Class II, Division 1, Groups E, F, G
Class II, Division 2, Groups F, G
Class III
CSA 4X

	Description	Catalog Number
	Box has 1/2" opening for threading to Flexible Coupling, and two 3/4" conduit openings (3/4 – 14NPT) and is furnished with one 3/4" close-up plug. Locking screw for horizontal adjustment. Trunnion bolts furnished. Aluminum, gray epoxy finish.	AF-JB
	Threads onto 2" pipe with tapered threads (2-11 – 1/2 NPT). Includes floodlight trunnion bolts. Locking screw for horizontal floodlight adjustment. Aluminum, gray epoxy finish.	AF-SF
	Has 180° horizontal adjustment – degree-marked. Facilitates mounting floodlight to crossarm or other flat surface, or to G-AM-8-WB Pole/Wall Mounting Bracket (see photo below). Includes floodlight trunnion bolts. Malleable iron, plated, chromate sealed, architectural bronze EPOXY finish.	G-AM-8-CA
 <p>Standard and Deep Dome 30° Angle</p>	Standard Dome Deep Dome 30° Angle	CMR-4ST CMR-4DD CMR-4AN
		CMR-4HB
	Connects to 3/4" Fixture Unit hub (3/4 – 14 NPT) and to 1/2" Junction Box or Pole-Top Accessory opening (1/2 – 14 NPT).	AF-EXL
<p>Quartz Emergency Lamp for Pulse Start Metal Halide and High Pressure Sodium Fixtures Fixtures can be supplied with a socket to accept a 150 W or 250 W, 120 V quartz lamp. This D.C. bayonet base socket is in addition to the standard lamp socket, independent of the lighting fixture voltage.</p> <p style="text-align: right;">Add Suffix-E</p>		
<p>HPS Smart Hot Restrike Smart Hot Restrike will immediately restrike an HPS lamp when power is restored after a momentary power interruption. The smart function removes the hot restrike ignitor from the circuit if the lamp burns out or is removed from the socket. Eliminates starter failures caused by prolonged operation with cycling or failing lamps and simplifies finding their location, reducing maintenance and repair costs.</p> <p style="text-align: right;">Optional for 150 W fixtures (HPS only) Add Suffix -SR</p>		
<p>HPS Hot Restrike Restrikes HPS lamp immediately when power is restored after a momentary power interruption.</p> <p style="text-align: right;">Optional for 150 W fixtures (HPS only) Add Suffix -R</p>		
<p>HPS Smart Starter Smart Starter for HPS and PSMH fixtures. Incorporates a 1-1/2-minute timer and performs as a conventional starter to normally start lamp. Removes itself from circuit if lamp burns out or is removed from socket. Eliminates starter failures caused by prolonged operation with cycling or failing lamps and simplifies finding their location, reducing maintenance and repair costs.</p> <p style="text-align: right;">Optional for all fixture watts Add Suffix -S</p> <p>G-AM-8-CA Crossarm Mounting Bracket Shown with G-AM-8-WB Pipe/Wall Mounting Bracket. The G-AM-8-WB bracket is not furnished with fixtures.</p> 		

Code•Master™ 2 HID Factory Sealed Floodlights

Marine (Outside Type). Explosionproof

Integrally Ballasted. 150 W, 250 W, 400 W HPS; 150 W, 175 W, 250 W, 320 W, 350 W, 400 W PSMH; 175 W, 250 W, 400 W MH. Mogul Base.

NEC:

Class 1, Division 1 and 2, Groups C, D
Marine Type Electric Fixtures
Outside Type (Salt Water)

CEC:

Class I, Division 1 and 2, Groups B, C, D
Class II, Division 1, Groups E, F, G
Class II, Division 2, Groups F, G
Class III
CSA 4X

Lamp	Watts	Volts	High Pressure Sodium ①		Ballast Amps		Metal Halide CWA		Fuse Quantity Required	Fuse Kit Catalog Number		
			Start	Operating	Pulse Start	Super CWA	Start	Operating		HPS	PSMH	MH ②
150	120		2.00	1.66	—	—	—	—	1	CF-10	—	—
	208		1.16	0.96	—	—	—	—	2	CF-5	—	—
	240		1.00	0.83	—	—	—	—	2	CF-5	—	—
	277		0.88	0.75	—	—	—	—	1	CF-5	—	—
	347		0.52	0.56	—	—	—	—	1	CF-5	—	—
	480		0.50	0.44	—	—	—	—	2	CF-3	—	—
175	120		—	—	1.10	1.86	1.30	1.80	1	—	CF-5	CF-5
	208		—	—	0.75	1.23	0.75	1.10	2	—	CF-3	CF-3
	240		—	—	0.65	0.98	0.65	0.90	2	—	CF-3	CF-3
	277		—	—	0.55	0.87	0.55	0.80	1	—	CF-2	CF-2
	347		—	—	0.25	0.65	0.50	0.65	1	—	CF-2	CF-2
	480		—	—	0.25	0.50	—	—	2	—	CF-2	—
250	120		1.75	2.70	1.96	2.50	1.20	2.60	1	CF-8	CF-8	CF-8
	208		1.00	1.50	1.13	1.45	0.65	1.50	2	CF-5	CF-5	CF-5
	240		0.85	1.30	0.98	1.25	0.60	1.30	2	CF-5	CF-5	CF-5
	277		0.75	1.15	0.85	1.10	0.50	1.12	1	CF-5	CF-3	CF-3
	347		0.60	0.93	0.62	0.90	0.80	0.90	1	CF-5	CF-3	CF-3
	480		0.40	0.65	0.32	0.67	—	—	2	CF-2	CF-2	—
320	120		—	—	3.30	3.25	—	—	1	—	CF-8	—
	208		—	—	1.90	1.90	—	—	2	—	CF-6	—
	240		—	—	1.60	1.65	—	—	2	—	CF-5	—
	277		—	—	1.40	1.40	—	—	1	—	CF-5	—
	347		—	—	0.70	1.10	—	—	1	—	CF-5	—
	480		—	—	0.45	0.85	—	—	2	—	CF-3	—
350	120		—	—	3.60	3.70	—	—	1	—	CF-10	—
	208		—	—	2.10	2.10	—	—	2	—	CF-8	—
	240		—	—	1.80	1.80	—	—	2	—	CF-5	—
	277		—	—	1.60	1.60	—	—	1	—	CF-5	—
	347		—	—	0.70	1.01	—	—	1	—	CF-5	—
	480		—	—	0.60	0.90	—	—	2	—	CF-3	—
400	120		3.10	3.90	3.50	4.00	3.25	4.00	1	CF-15	CF-10	CF-10
	208		1.80	2.25	2.00	2.30	1.90	2.30	2	CF-8	CF-8	CF-8
	240		1.60	1.95	1.75	2.00	1.65	2.00	2	CF-5	CF-5	CF-5
	277		1.35	1.70	1.50	1.75	1.40	1.75	1	CF-5	CF-5	CF-5
	347		1.00	1.32	1.10	1.35	1.20	1.40	1	CF-5	CF-5	CF-5
	480		0.80	1.00	0.75	1.00	—	—	2	CF-5	CF-3	—

Fuse Kit includes fuse, fuse holder and necessary hardware for field installation. Mounts easily in ballast body with one screw. Order one fuse for 120 and 277 V, and 2 fuses for 208, 240 and 480 V. CF-2 = 2 amp; CF-3 = 3 amp; CF-5 = 5 amp; CF-6 = 6 amp; CF-8 = 8 amp; CF-10 = 10 amp

① 50 through 150 W HPS have H.P.F. High Reactance ballasts; 250 W and 400 W HPS have CWA ballasts.

② Mercury vapor and metal halide luminaires are not available for purchase within the United States. Please check with your countries governing legislation regarding allowable lamp types before ordering.

Code•Master™ 2 HID Factory Sealed Floodlights

Marine (Outside Type). Explosionproof

Integrally Ballasted. 150 W, 250 W, 400 W HPS; 150 W, 175 W, 250 W, 320 W, 350 W, 400 W PSMH; 175 W, 250 W, 400 W MH. Mogul Base.

NEC:
Class 1, Division 1 and 2, Groups C, D
Marine Type Electric Fixtures
Outside Type (Salt Water)

CEC:
Class I, Division 1 and 2, Groups B, C, D
Class II, Division 1, Groups E, F, G
Class II, Division 2, Groups F, G
Class III
CSA 4X

Dimensions in Millimeters (Inches)

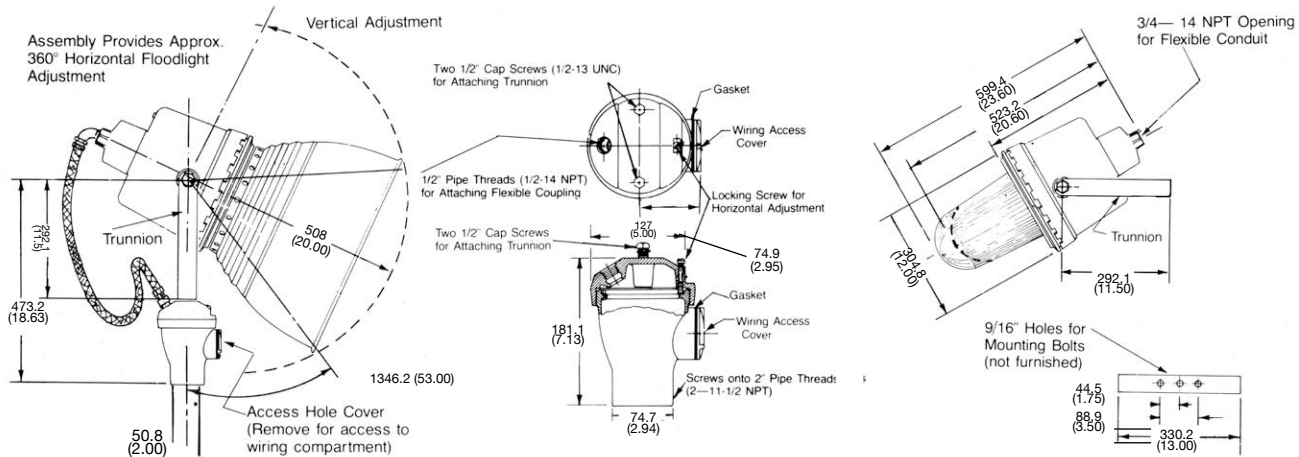
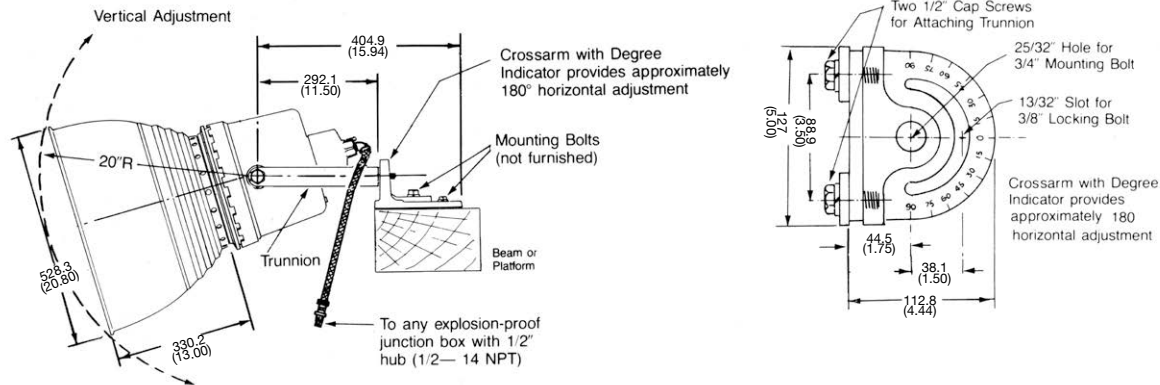
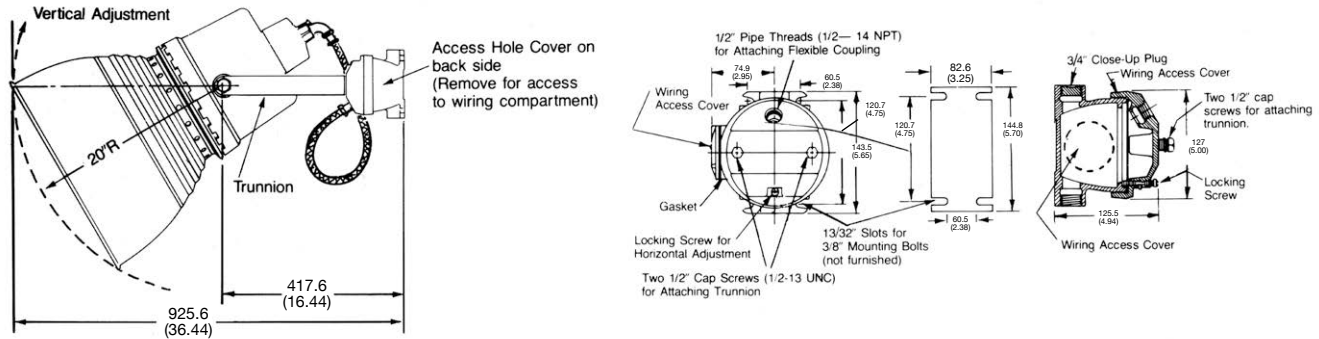

Weights kg (lb)

150 W	175 W	250 W	320 W	350 W	400 W
21 (46.30)	21 (46.30)	32 (70.55)	32 (70.55)	32 (70.55)	32 (70.55)

Code•Master™ 2 HID Factory Sealed Floodlights

Marine (Outside Type). Explosionproof

Typical Footcandle Values for Iso-Footcandle Curves. Data Based on 400 W HPS (50,000 Lumens) Clear Mogul Base Lamps.

NEC:
 Class 1, Division 1 and 2, Groups C, D
 Marine Type Electric Fixtures
 Outside Type (Salt Water)

CEC:
 Class I, Division 1 and 2, Groups B, C, D
 Class II, Division 1, Groups E, F, G
 Class II, Division 2, Groups F, G
 Class III
 CSA 4X

Photometric Data

400 W HPS Floodlight at 45° Angle with High Bay Reflector ①

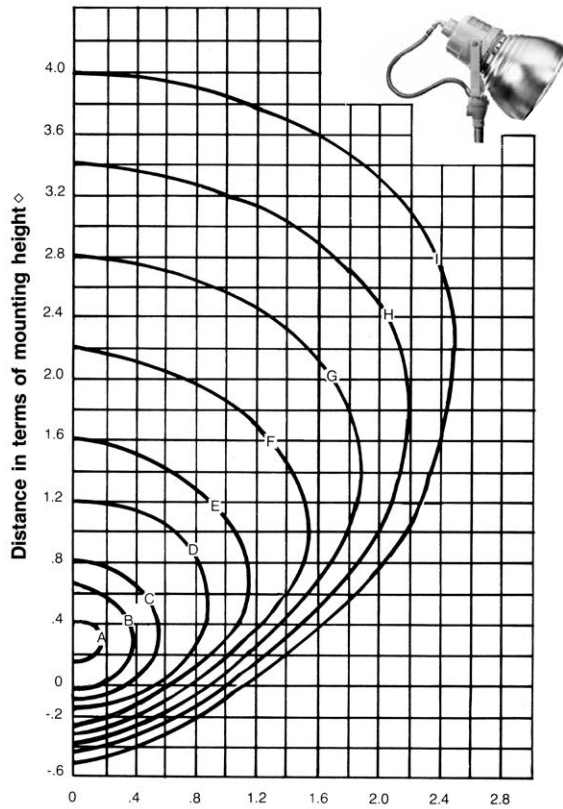

Mounting Height (feet)	FOOTCANDLE VALUES FOR ISO-FOOTCANDLE CURVES								
	A	B	C	D	E	F	G	H	I
15	52.52	43.34	31.00	17.05	10.23	4.77	2.43	1.36	0.84
20	29.54	24.38	17.44	9.59	5.75	2.68	1.37	0.77	0.47
25	18.91	15.60	11.16	6.14	3.68	1.72	0.87	0.49	0.30
30	13.13	10.84	7.75	4.26	2.56	1.19	0.61	0.34	0.31
35	9.65	7.96	5.69	3.13	1.88	0.88	0.45	0.25	0.15
40	7.39	6.10	4.36	2.40	1.44	0.67	0.34	0.19	0.12

400W MH Floodlight at 45° Angle with High Bay Reflector

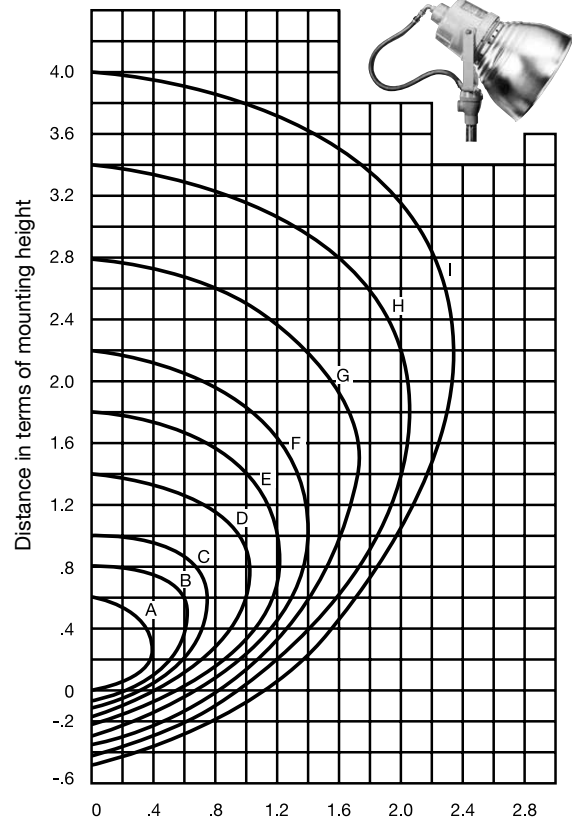

Mounting Height (feet)	FOOTCANDLE VALUES FOR ISO-FOOTCANDLE CURVES								
	A	B	C	D	E	F	G	H	I
15	33.97	22.10	16.12	9.69	6.40	4.12	2.13	1.13	.67
20	19.11	12.43	9.07	5.45	3.60	2.31	1.20	.64	.38
25	12.23	7.96	5.80	3.49	2.30	1.48	.77	.41	.24
30	8.49	5.52	4.03	2.42	1.60	1.03	.53	.28	.17
35	6.24	4.06	2.96	1.78	1.18	.76	.39	.21	.12
40	4.78	3.11	2.27	1.36	.90	.58	.30	.16	.10

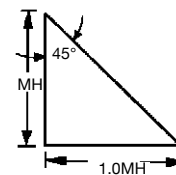
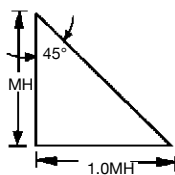

① For 250 Watt HPS Clear, 30,000 Lumen lamp, multiply all FTC values by 0.60.

EFL Series HID and Quartz Floodlights

Explosionproof

NEC/CEC:
Class I, Zone 1 and 2
Ex de IIB T1/T2/T3
Class I, Zone 1 and 2
AEx de IIB T1/T2/T3
IP66 / 67

Applications

- Designed for large area lighting in industrial outdoor and indoor explosionproof areas.
- Ideal for use in Zone 1 and 2 applications in the oil and gas industry in such areas as refineries, pipelines and offshore drilling rigs.

Features

- Fast and easy tubular lamp replacement via threaded entry at the end of the fixture. Suitable for HPS and HPI-T MH lamps only. Other lamps require lens cover removal for servicing.
- Lamp holder can be easily field adjusted for either a narrow or wide beam type.
- Thermally separated ballast provides for extended life.
- Easy, efficient wiring process due to a separate Ex e terminal chamber.
- Choice of mounting with a galvanized yoke bracket, fixed horizontal brackets, two different sizes of tube/pole mount brackets or without brackets for custom installation.
- Tempered safety glass lens is factory sealed into the cover frame.
- Suitable for use in up to 55 °C (131 °F) ambient temperatures.
- Two – M20 threaded cable entries for ease of wiring. Supplied c/w one close-up plug and one Ex e non-armored cable gland.
- One external 4mm² and one 6mm² earth/ground terminals.
- Universal mounting for vertical or horizontal positioning.
- Reversible hinge allows for fixture access from either side.
- Mogul Base Lamp is supplied as standard. Optional export version would be supplied with E40 export socket.
- Highly polished internal Aluminium reflector.

Standard Materials

- Housing and door: copperfree marine grade aluminum alloy
- Lens: tempered safety glass
- Reflector: highly polished aluminium
- Closure bolts: 316 stainless steel

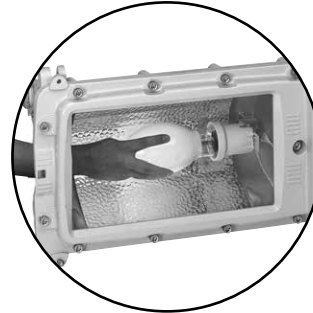

Standard Finishes

- Exterior finish: Housing and door: gray polyester epoxy

Options

- Overhead diffuser. Black painted, galvanized steel. Suffix –D.
- Protective wire guard. Zinc plated steel. Suffix –G.
- Hot Restrike Igniter. Ignites a hot lamp shortly after a power dip or outage extinguishes the lamp. Suffix –R.
- Safety Starter. Shuts off device in the event of a lamp failure. Suffix –S.
- Additional wiring terminals. For 3 Phase loop in/out. Suffix –T.

NEC/CEC Certifications and Compliances

- cCSAus: LR25428

Catalog Numbering Guide

EFL	H	40	B	TT	L
EFL Series: Explosionproof Floodlights	Lamp Type: H - Metal Halide/ Mercury Vapor L - High Pressure Sodium P - Pulse Start Metal Halide Q - Halogen	Wattage: 10 - 1000W Quartz Halogen 15 - 150W HPS, MH ① 17 - 175W PSMH, MH ① 20 - 200W PSMH 25 - 250W HPS, MH ① 40 - 400W HPS, MH ① 50 - 500W Quartz Halogen	Mounting: B - Galvanized Yoke Bracket (Std. Offering) H - Set of Horizontal Fittings C1 - Clamp Bracket. For 1-1/4" – 1-1/2" Tube C2 - Clamp Bracket. For 2" Tube N - No Mounting Hardware Supplied	HID Ballast Type and Voltage TT - CWA for 120/277/347V MT - CWA for 120/208/240/277V XP - CWA for 120/220-240V 50 Hz C5 - CWI for 480V C6 - CWI for 600V A1 - No Ballast - Quartz Only	Accessory Options: D - Overhead Diffuser G - Protective Wire Guard L - Lamp Included (HID Only) R - Protected Hot R Strike S - Safety Starter (not required with R)

① Mercury and Mercury Vapor luminaires are not available for purchase within the United States. Please check with your countries governing legislation regarding allowable lamp types before ordering.

EFL Series HID and Quartz Floodlights

Explosionproof





NEC/CEC:
Class I, Zone 1 and 2
Ex de IIB T1/T2/T3
Class I, Zone 1 and 2
AEx de IIB T1/T2/T3
IP66 / 67

Fixture Ordering Supplied Std. w/ Yoke Mtg.	T Code	T Code	Input Voltages	Fixture Wt.	Vol.	Catalog Number
	40 °C (104 °F)	55 °C (131 °F)				
Metal Halide/Mercury Vapor ③						
150 W	T3	T3	120/277/347 V 60Hz	60	3	EFLH15B-TTCN ①
250 W	T3	T3	120/277/347 V 60Hz	62	3	EFLH25B-TTCN
400 W	T3	T3	120/277/347 V 60Hz	66	3	EFLH40B-TTCN
Pulse Start Metal Halide						
175 W	T3	T3	120/277/347 V 60Hz	62	3	EFLP17B-TTCN ①
200 W	T3	T3	120/277/347 V 60Hz	62	3	EFLP20B-TTCN ①
250 W	T3	T3	120/277/347 V 60Hz	25	3	EFLP25B-TTCN ①
400 W	T3	T3	120/277/347 V 60Hz	66	3	EFLP40B-TTCN ①
High Pressure Sodium						
150 W	T3	T3	120/277/347 V 60Hz	60	3	EFL15B-TTCN
250 W	T3	T3	120/277/347 V 60Hz	62	3	EFL25B-TTCN
400 W	T3	T3	120/277/347 V 60Hz	66	3	EFL40B-TTCN
Tubular Quartz Halogen						
500 W	T1	T1	Lamp sockets rated 125-250 Vac	71	3	EFLQ50B-A1CN
1000 W	T1	T1		71	3	EFLQ10B-A1CN

Voltages – Add Suffix Below to Catalog Number

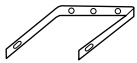
Volts	120	208	220	240	277	347	480	600
CWA	-MT	-MT	-	-MT	-MT	-	-A6 ②	-
CWI	-C1	-C2	-	-C3	-	-C5	-C6	-C7
50 Hz CWA	-XP	-	-XP	-XP	-	-	-	-

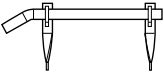
Accessories and Replacement Parts

Size mm (in)	Catalog Number	Catalog Number
Galvanized Steel Hinged Bracket		Clip on Diffuser
	PNTB1	 PND1
Pole Mounting Brackets		Protective Guard
	31.8 to 38.1 (1.25 to 1.50)	 PNG1
	50.8 (2.00)	
	PNPB115	
	PNPB120	
Horizontal Fixed Mounting Bracket		
	PNHB1	

① Depending on availability of tubular type lamps, may require removal of lens cover for servicing.

② Supplied as export voltage only. Not suitable for CEC applications

③ Mercury and Mercury Vapor luminaires are not available for purchase within the United States. Please check with your countries governing legislation regarding allowable lamp types before ordering.

EFL Series HID and Quartz Floodlights

Explosionproof

NEC/CEC:
Class I, Zone 1 and 2
Ex de IIB T1/T2/T3
Class I, Zone 1 and 2
AEx de IIB T1/T2/T3
IP66 / 67

Appleton

HID/FLOODLIGHT: NEC/CEC EXPLOSIONPROOF

Dimensions in Millimeters (Inches)

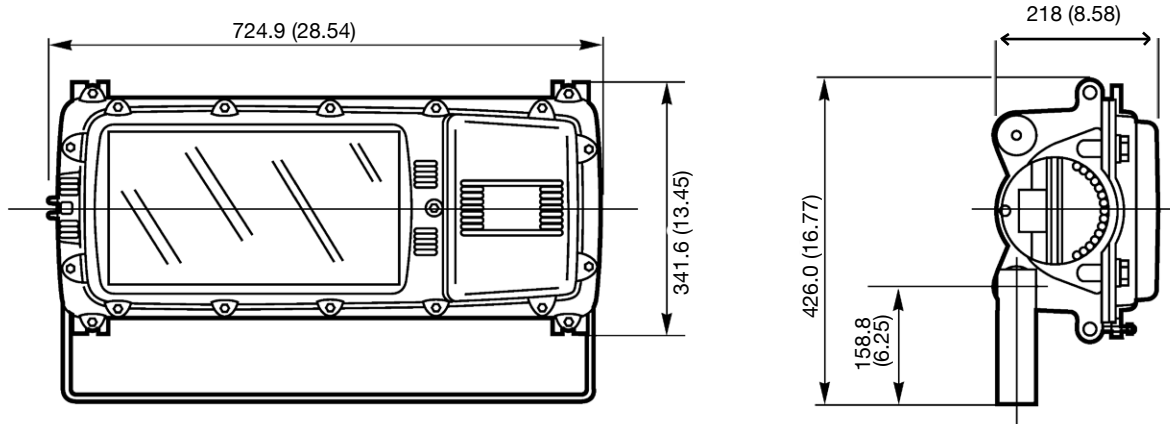

Clamp Brackets For Tubing

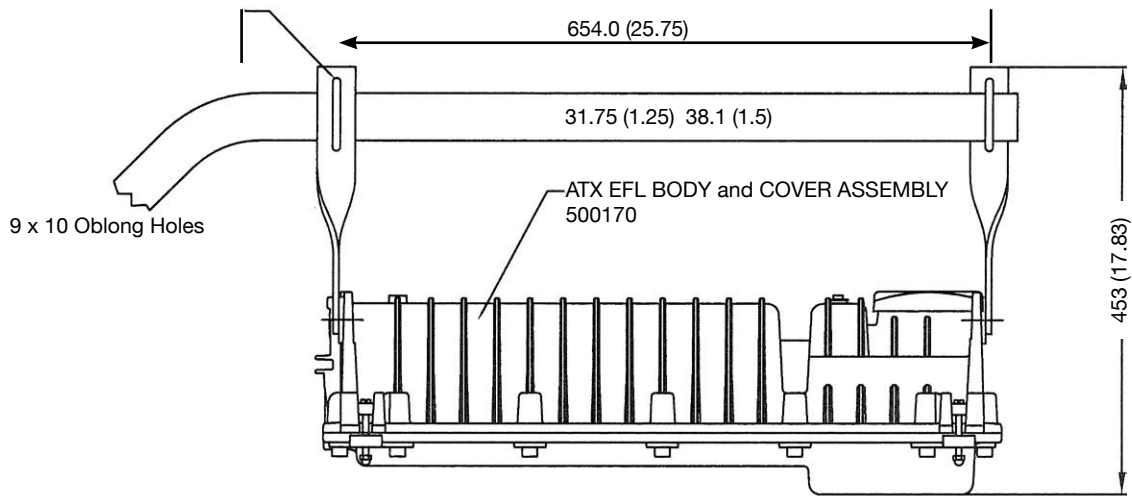

EFL Series HID and Quartz Floodlights

Explosionproof

NEC/CEC:
 Class I, Zone 1 and 2
 Ex de IIB T1/T2/T3
 Class I, Zone 1 and 2
 AEx de IIB T1/T2/T3
 IP66 / 67

Photometric Data ①

Polar curves for a 1000 lm flux, according to NF C 71-120
 Luminaire symbol according to NF C 71-121

----- Longitudinal
 _____ Transverse

250W halide Narrow Beam

Efficiency 68.3%

NF C 71-121: 0,68B

**CANDELA
 DISTRIBUTION**

	0-180	90-270
0	505	505
5	515	499
10	512	469
15	501	403
20	476	312
25	453	248
30	427	190
35	394	146
40	368	117
45	290	97
50	160	12
55	51	7
60	34	4
65	15	4
70	6	4

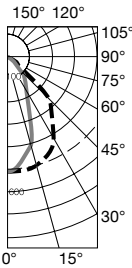

250W halide Wide Beam

Efficiency 67.9%

NF C 71-121: 0,68C

**CANDELA
 DISTRIBUTION**

	0-180	90-270
0	301	301
5	303	318
10	299	342
15	294	387
20	287	382
25	286	306
30	271	237
35	231	208
40	172	186
45	133	140
50	83	104
55	48	18
60	34	8
65	23	6
70	6	6

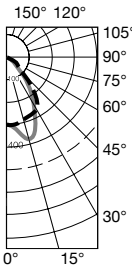

400W halide Narrow Beam

Efficiency 49.3%

NF C 71-121: 0,49C

**CANDELA
 DISTRIBUTION**

	0-180	90-270
0	217	217
5	210	219
10	218	231
15	223	205
20	238	193
25	255	148
30	266	132
35	263	130
40	244	116
45	201	104
50	136	37
55	85	15
60	51	8
65	28	6
70	5	4

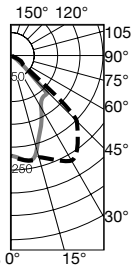

400W halide Wide Beam

Efficiency 46.7%

NF C 71-121: 0,46C

**CANDELA
 DISTRIBUTION**

	0-180	90-270
0	105	105
5	104	106
10	108	130
15	124	165
20	148	177
25	167	183
30	165	147
35	142	127
40	116	113
45	74	115
50	52	103
55	48	40
60	44	13
65	34	9
70	18	6

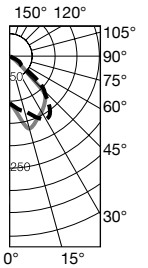

① 400 W MH: Efficiency rate lower than 250 W due to thermal deflector between glass and lamp, requested for T3.

Areamaster™ ATEX PN Series Floodlights

Zone 2 – 21 and 22. Metal Halide, High Pressure Sodium, Mercury Vapor

Listed for simultaneous exposure to gas, combustible dusts and flammable gases or vapors.

ATEX/IECEX:
Zone 2 – 21 and 22
⊕ II 2 D - ⊕ II 3 GD
IP66 - IK07/08

Applications

- Powerful, efficient floodlights for large areas such as industrial complexes and ship loading areas.
- Rated for use in hazardous areas.

Features

- Highly efficient, integrally ballasted floodlight. Has compact, lightweight, yet rugged die cast aluminum construction.
- Simple installation and maintenance.
- Integral ballast:
 - ATEX/IEC: 230/240 V, 50 Hz
- One piece lens cover.
- Heavy duty, high temperature silicone rubber gasket, firmly seated.
- Socket: E40 (E27 for 70 W HPS version).
- Reflectors: double segment compound parabolic with finish for maximum efficiency.
- Mounting: yoke mount.

Standard Materials

- Ballast housing and lens door: copperfree (4/10 of 1% max.) aluminum
- Gasket: silicone rubber
- Socket: heavy duty porcelain with heavy gauge brass shell
- Reflector: finished aluminum
- Yoke mount: zinc plated steel
- Bolts: stainless steel

Standard Finishes

- Ballast housing, lens cover, yoke and pole mount: architectural bronze polyester
- Socket: porcelain

ATEX/IECEX Certifications and Compliances

- Certification Type: PjN
 - Gas: Zone 2
 - Conforming to ATEX 94/9/CE: ⊕ II 3 G
 - Type of Protection: Ex nR IIC Gc
 - Temperature Class: T2 to T4
 - Ambient Temperature: -40 °C to +55 °C (-40 °F to +131 °F) [-40 °C to +50 °C (-40 °F to 131 °F) for body size L]
 - ATEX Certificate: LCIE 08 ATEX 6035X
 - IECEX Certificate: IECEX LCI 04.0015
 - Dust: Zone 22
 - Conforming to ATEX 94/9/CE: ⊕ II 3 D
 - Type of Protection: Ex t IIIC Dc
 - Surface Temperature: T117 °C to T228 °C (T243 °F to T442 °F)
 - Ambient Temperature: -40 °C to +55 °C (-40 °F to +131 °F) (-40 °C to +50 °C (-40 °F to 131 °F) for body size L)
 - ATEX Certificate: LCIE 08 ATEX 6035X
 - IECEX Certificate: IECEX LCI 04.0015
 - Dust: Zone 21
 - Conforming to ATEX 94/9/CE: ⊕ II 2 D
 - Type of Protection: Ex tD A21
 - Surface Temperature: T65 °C to T182 °C (T149 °F to T360 °F)
 - Ambient Temperature: -20 °C to +40 °C (-4 °F to +104 °F)
 - CE Declaration of Conformity: 50274
 - ATEX Certificate: LCIE 02 ATEX 6246X



- Index of Protection according EN/IEC 60529: IP66
- Impact Resistance (shock): IK07 with glass diffuser, IK08 with polycarbonate diffuser

EURASEC Certification

- EURASEC N° TC RU C-FR.Г505.B.00912

Other Certification

- Size M - Certification Type: PjN
 - INMETRO Certificate: BVC 11.0394-X ①

① Inmetro certification available on special request only. Contact your local sales representative for more information

Areamaster™ ATEX PN Series Floodlights

Zone 2 – 21 and 22. Metal Halide, High Pressure Sodium, Mercury Vapor

Listed for simultaneous exposure to gas, combustible dusts and flammable gases or vapors.

ATEX/IECEX:
 Zone 2 – 21 and 22
 Ⓢ II 2 D - Ⓢ II 3 GD
 IP66 - IK07/08

Order using catalog numbering guide below or select catalog number from tables on following pages.

Catalog Numbering Guide – Areamaster ATEX PN Series Floodlights

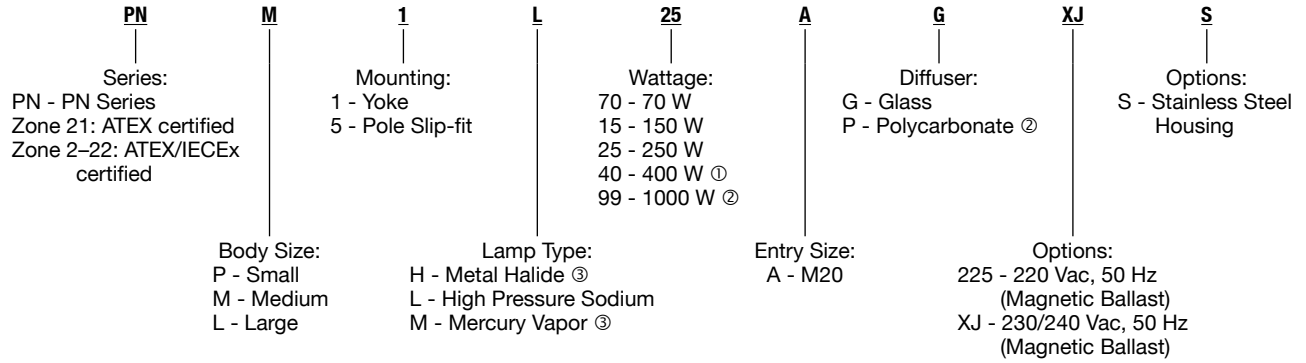

HID/FLOODLIGHT: ATEX/IECEX FLAMEPROOF

① 400 Watt is rated for Zones 21-22 and 1000 Watt is rated for Zones 2-22 when used with large body. Select glass diffuser.

② Polycarbonate diffuser is not rated for use in Zones 2-22.

③ Mercury vapor and metal halide luminaires are not available for purchase within the United States. Please check with your countries governing legislation regarding allowable lamp types before ordering.

Areamaster™ ATEX PN Series Floodlights

Zone 2 – 21 and 22. Metal Halide, High Pressure Sodium, Mercury Vapor

Listed for simultaneous exposure to gas, combustible dusts and flammable gases or vapors.

ATEX/IECEX:
Zone 2 – 21 and 22
II 2 D - II 3 GD
IP66 - IK07/08

Zone 21 (Dust)

Operating Position	Dust Surface Temperatures for Ta = +40 °C (+104 °F)		Time Before Opening in Minutes
	Glass Diffuser	Polycarbonate Diffuser	
Lamp Type and Wattage			
70 W High Pressure Sodium	+75 °C (+167 °F)	+65 °C (+149 °F)	50
150 W High Pressure Sodium	+101 °C (+214 °F)	+91 °C (+196 °F)	25
250 W High Pressure Sodium	+127 °C (+261 °F)	+117 °C (+243 °F)	15
250 W Metal Halide ①	+123 °C (+253 °F)	+113 °C (+235 °F)	15
250 W Mercury ①	+136 °C (+277 °F)	+131 °C (+268 °F)	15
400 W High Pressure Sodium	+126 °C (+26 °F)	+121 °C (+250 °F)	30
1000 W High Pressure Sodium	+177 °C (+351 °F)	-	30
1000 W Metal Halide ①	+182 °C (+360 °F)	-	30

Zone 2 (Gas)

Lamp Type and Wattage	T Rating for Ta = +40 °C (+104 °F)	T Rating for Ta = +50 °C (+122 °F)	T Rating for Ta = +55 °C (+131 °F)
70 W High Pressure Sodium	T4	T4	T4
150 W High Pressure Sodium	T4	T4	T4
150 W Metal Halide ①	T4	T4	T4
250 W High Pressure Sodium	T3	T3	T3 – Cable T ° = +82 °C (+180 °F)
250 W Metal Halide ①	T3	T3	T3
250 W Mercury ①	T3	T3	T3 – Cable T ° = +81 °C (+178 °F)
400 W High Pressure Sodium	T3	T3 – Cable T ° = +87 °C (+187 °F)	T2 – Cable T ° = +92 °C (+198 °F)
400 W Metal Halide ①	T2	T2 – Cable T ° = +84 °C (+183 °F)	T2 – Cable T ° = +89 °C (+192 °F)
400 W Mercury ①	T2	T2 – Cable T ° = +84 °C (+183 °F)	T2 – Cable T ° = +89 °C (+192 °F)
1000 W High Pressure Sodium	T3	T3	-
1000 W Metal Halide ①	T3	T3	-

Zone 22 (Dust)

Lamp Type and Wattage	T Rating for Ta = +40 °C (+104 °F)	T Rating for Ta = +50 °C (+122 °F)	T Rating for Ta = +55 °C (+131 °F)
70 W High Pressure Sodium	117 °C (242 °F)	-	-
150 W High Pressure Sodium	130 °C (266 °F)	-	-
150 W Metal Halide ①	128 °C (262 °F)	-	-
250 W High Pressure Sodium	160 °C (320 °F)	-	T3 – Cable T ° = +82 °C (+180 °F)
250 W Metal Halide ①	175 °C (347 °F)	-	-
250 W Mercury ①	181 °C (358 °F)	-	T3 – Cable T ° = +81 °C (+178 °F)
400 W High Pressure Sodium	198 °C (388 °F)	T3 – Cable T ° = +87 °C (+187 °F)	T2 – Cable T ° = +92 °C (+198 °F)
400 W Metal Halide ①	228 °C (442 °F)	T2 – Cable T ° = +84 °C (+183 °F)	T2 – Cable T ° = +89 °C (+192 °F)
400 W Mercury ①	227 °C (441 °F)	T2 – Cable T ° = +84 °C (+183 °F)	T2 – Cable T ° = +89 °C (+192 °F)
1000 W High Pressure Sodium	+187 °C (+369 °F) for Ta = +50 °C (+122 °F)	Cable T ° = +90 °C (+194 °F)	-
1000 W Metal Halide ①	+192 °C (+378 °F) for Ta = +50 °C (+122 °F)	Cable T ° = +90 °C (+194 °F)	-

① Mercury vapor and metal halide luminaires are not available for purchase within the United States. Please check with your countries governing legislation regarding allowable lamp types before ordering.

Areamaster™ ATEX PN Series Floodlights

Zone 2 – 21 and 22. Metal Halide, High Pressure Sodium, Mercury Vapor

Listed for simultaneous exposure to gas, combustible dusts and flammable gases or vapors.

ATEX/IECEX:
Zone 2 – 21 and 22
Ⓢ II 2 D - Ⓢ II 3 GD
IP66 - IK07/08

Lamp Type and Wattage	Weight kg (lb)	Volume dm ³ (in ³)	Permissible lamps (not supplied)	Body Size	Catalog Number ③④
Standard with Lamp Glass Sealed on Frame					
70 W HPS	12.1 (26.7)	62.5 (3814)	Ovoid/Tubular	Medium	PNM1L70AGXJ
150 W HPS	12.9 (28.4)	62.5 (3814)	Ovoid/Tubular	Medium	PNM1L15AGXJ
250 W HPS	14.3 (31.5)	62.5 (3814)	Ovoid/Tubular	Medium	PNM1L25AGXJ
400 W HPS	16.0 (35.3)	62.5 (3814)	Ovoid/Tubular	Medium	PNM1L40AGXJ ①
400 W HPS	–	–	Ovoid/Tubular	Large	PNL1L40AGXJ ①
150 W MH ④	12.9 (28.4)	62.5 (3814)	Ovoid/Tubular	Medium	PNM1H15AGXJ
250 W MH ④	14.3 (31.5)	62.5 (3814)	Ovoid/Tubular	Medium	PNM1H25AGXJ
400 W MH ④	16.0 (35.3)	62.5 (3814)	Tubular	Medium	PNM1H40AGXJ ①
400 W MH ④	–	–	Ovoid/Tubular	Large	PNL1H40AGXJ ①
250 W MV ④	12.9 (28.4)	62.5 (3814)	Ovoid	Medium	PNM1M25AGXJ
400 W MV ④	13.8 (30.4)	62.5 (3814)	Ovoid/Tubular	Medium	PNM1M40AGXJ ①
With External Polycarbonate Weatherproof Protection ②					
70 W HPS	13.2 (29.1)	62.5 (3814)	Ovoid/Tubular	Medium	PNM1L70APXJ
150 W HPS	14.0 (30.9)	62.5 (3814)	Ovoid/Tubular	Medium	PNM1L15APXJ
250 W HPS	15.4 (34.0)	62.5 (3814)	Ovoid/Tubular	Medium	PNM1L25APXJ
400 W HPS	–	–	Ovoid/Tubular	Large	PNL1L40APXJ ①
150 W MH ④	14.0 (30.9)	62.5 (3814)	Ovoid/Tubular	Medium	PNM1H15APXJ
250 W MH ④	15.4 (34.0)	62.5 (3814)	Ovoid/Tubular	Medium	PNM1H25APXJ
400 W MH ④	–	–	Ovoid/Tubular	Large	PNL1H40APXJ
250 W MV ④	14.0 (30.9)	62.5 (3814)	Ovoid	Medium	PNM1M25APXJ ①

① 400 Watt is rated for Zones 21-22 and 1000 Watt is rated for Zones 2-22 when used with large body. Select glass diffuser.

② Polycarbonate diffuser is not rated for use in Zones 2-22.

③ For a 220 Vac, 50 Hz, magnetic ballast, replace the letters **XJ** in the 10th and 11th positions with the letters **225**; example: PNP1L70AG225.

④ Mercury vapor and metal halide luminaires are not available for purchase within the United States. Please check with your countries governing legislation regarding allowable lamp types before ordering.



Areamaster™ ATEX PN Series Floodlights

Zone 2 – 21 and 22. Metal Halide, High Pressure Sodium, Mercury Vapor

Listed for simultaneous exposure to gas, combustible dusts and flammable gases or vapors.

ATEX/IECEX:
Zone 2 – 21 and 22
II 2 D - II 3 GD
IP66 - IK07/08

Accessories

Description	Catalog Number
Fall Prevention Kit 1.2 m (3.94 in) stainless steel chain for M20 cable entry	FESCM20
 Slip-Fitter Adapter — fits medium body	G-SF20
 Slip-Fitter Adapter — fits large body/1000 Watt floodlight	G-AM-8-SF

Dimensions in Millimeters (Inches)

Size M

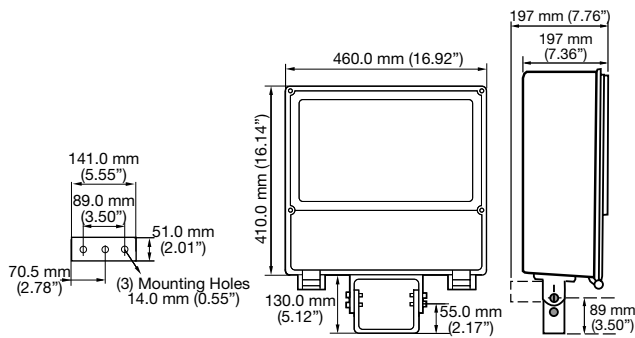

Size L

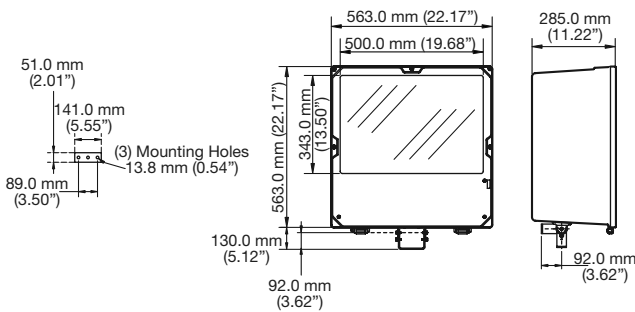

Photometric Data

Lamps: 70 W High Pressure Sodium

Polar curves for a 1000 lm flux, according to NF C 71-120
Luminaire symbol according to NF C 71-121

Degrees	Candelas	
	(0-180)	(90-270)
0	487	487
5	439	461
10	416	387
15	372	324
20	208	290
25	129	294
30	116	319
35	111	318
40	101	289
45	86	193
50	70	150
55	84	141
60	62	132
65	22	88
70	9	15

Total Luminaire Efficiency = 74.6%

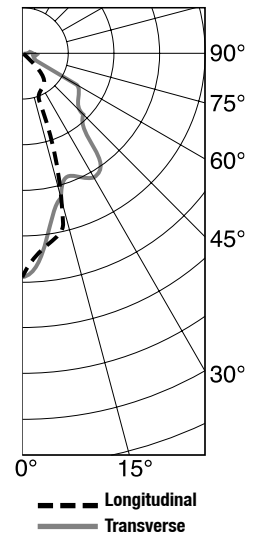

HID/FLOODLIGHT: ATEX/IECEX FLAMEPROOF

ATX™ PC Series Floodlights

Flameproof. Metal Halide, High Pressure Sodium, Mercury Vapor, Halogen

ATEX/IECEX:
Zone 1 and 2 - 21 and 22
⊕ II 2 GD
IP66/67 – IK10

Applications

- Designed for large area lighting in industrial outdoor and indoor hazardous areas.
- Ideal for use in Zones 1 and 2 and 21 and 22 in the oil and gas industry. In locations such as: refineries, pipelines, warehouses, offshore platforms and drilling rigs.

Features

- Gray epoxy painted light marine grade aluminum housing and door.
- Fast and easy lamp replacement via threaded cover on the side of the fixture. The cover is fitted with a short safety chain.
- Lampholder of the ATEX/IEC version can be easily field-adjusted for either a narrow or wide beam.
- Fixtures operate safely in high ambient temperatures up to +55 °C (+131 °F) and in low ambient temperature up to -25 °C (-13 °F).
- Electrical components (ballast, ignitor and capacitor) are thermally separated from the lighting compartment with an insulating protection, providing extended life.
- Easy and efficient wiring due to separate Ex e terminal box with wiring onto 2 captive terminals 2 x 6 mm² (2 x 0.009 in²); 2 internal earth terminals capacity 6 mm² (0.009 in²) and 1 external earth terminal capacity 4 mm² (0.006 in²).
- 2 x 20 mm (2 x 0.79 in) clearance holes throughwire cable entries supplied with:
 - One Ex e unarmored cable gland — sealing diameter 6.5 mm to 14.5 mm (0.2 in to 0.57 in)
 - One blanking plug
 - Two M20 locknuts
- For use with either tubular or ellipsoidal shape lamps. See ordering information for details.
- Choice of mounting with galvanized hinged bracket fixed mounting or tube/pole mounting with galvanized brackets.
- Thermoshock and impact-resistant glass factory sealed into the floodlight body.
- Operates in any position.
- Reversible hinge allows for fixture access from either side.
- Internal symmetric reflector.

Standard Materials

- Housing and door: copperfree marine-grade aluminum alloy
- Lens: toughened safety glass
- Reflector: bright highly polished aluminum
- Bolts: stainless steel bolt
- Cable gland and blanking plug: polyamide
- Locknut: nickel plated brass

Standard Finishes

- Housing and door: gray epoxy powder paint

Options

- Other voltages, please contact your sales representative.
- Terminal block with 2 more terminals for wiring with 3 phases plus Neutral in 380/415 V (loop in/loop out wiring possible): add suffix **-T** at the end of the catalog number.
- Asymmetrical light distribution is available, add suffix **-A** to end of catalog number.
- Screwed-on overhead diffuser out of galvanized steel with black painting (see accessories).
- Screwed-on zinc-coated protection guard (see accessories).

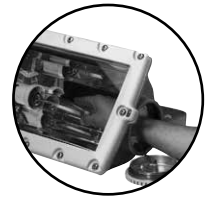
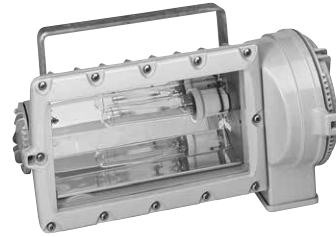

ATEX/IECEX Certifications and Compliances

- Certification Type: PJD
 - Gas: Zone 1 and 2
 - Conforming to ATEX 94/9/CE: ⊕ II 2 G
 - Type of Protection: Ex de IIC
 - Temperature Class: See *T Rating (Gas) and Surface Temperature (Dust) Table*
 - Dust: Zone 21 - 22
 - Conforming to ATEX 94/9/CE: ⊕ II 2 D
 - Type of Protection: Ex tD A21
 - Surface Temperature: See *T Rating (Gas) and Surface Temperature (Dust) Table*
- Ambient Temperature: standard fixture: -20 °C ≤ Ta ≤ +55 °C (-4 °F ≤ Ta ≤ +131 °F); with asymmetrical optic "C": -25 °C (-13 °F)
- CE Declaration of Conformity: 50207
- ATEX Certificate: LCIE 99/ ATEX 6002
- IECEX Certificate: IECEX LCI 04.0020
- Index of Protection according EN/IEC 60529: IP66/67
- Impact Resistance (shock): IK10

EURASEC Certification

- EURASEC N° TC RU C-FR.Г505.B.00912

Other Certification

- INMETRO Certificate: BVC12.2098 ①

① Inmetro certification available on special request only. Contact your local sales representative for more information

ATX™ PC Series Floodlights

Flameproof. Metal Halide, High Pressure Sodium, Mercury Vapor, Halogen

ATEX/IECEX:
Zone 1 and 2 - 21 and 22
II 2 GD
IP66/67 - IK10

Order using catalog numbering guide below or select catalog number from the following pages.

Catalog Numbering Guide — PC Series Floodlights

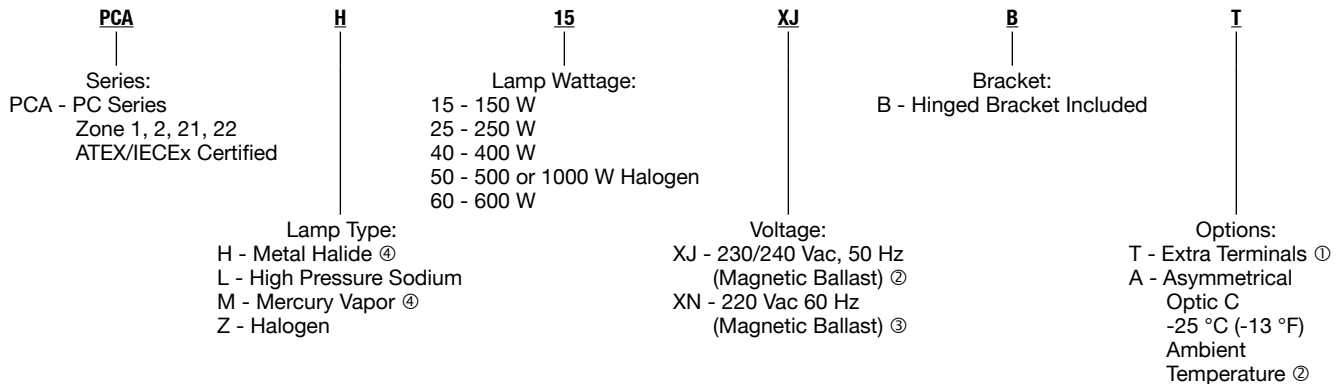

T Rating (Gas) and Surface Temperature (Dust) Table

Lamp Type and Wattage	Gas Temperature Rating According to Ta			Dust Surface Temperature °C (°F)
	+40 °C (+104°F)	+50 °C (+122°F)	+55 °C (+131°F)	
2 x 70 W - H3	T4	T4	T4	+130 (+266)
150 W High Pressure Sodium	T4	T3	T3	+145 (+293)
250 W High Pressure Sodium	T3	T3	T3	+195 (+383)
250 W Metal Halide	T3	T3	T3	+197 (+387)
250 W Mercury Vapor	T3	T3	T3	+194 (+381)
400 W High Pressure Sodium	T3	T3	T3	+189 (+372)
400 W Metal Halide	T3	T3	T3	+193 (+379)
400 W Mercury Vapor	T3	T3	T3	+195 (+383)
600 W High Pressure Sodium	T2	T2	T2	+257 (+495)
500 W Halogen	T2	T2	T2	+267 (+513)
1000 W Halogen	T1	T1	T1	+378 (+712)

① 3 Phase + Neutral.

② Certified for use in ATEX/IECEX governed locations only.

③ Not certified for use in ATEX/IECEX governed locations.

④ Mercury vapor and metal halide luminaires are not available for purchase within the United States. Please check with your countries governing legislation regarding allowable lamp types before ordering.

ATX™ PC Series Floodlights

Flameproof. Metal Halide, High Pressure Sodium, Mercury Vapor, Halogen

ATEX/IECEX:
Zone 1 and 2 - 21 and 22
II 2 GD
IP66/67 – IK10

Lamp Wattages	Lampholder	Voltage (+/-10%)	Lamp Type		Weight kg (lb)	Volume dm ³ (in ³)	Catalog Number ① ②
			Ellipsoidal	Tubular			
High Pressure Sodium							
150	E40	230/240 V, 50 Hz	x	x	29.0 (64)	104.4 (6374)	PCAL15XJB
150	E40	220 Vac, 60 Hz	x	x	29.0 (64)	104.4 (6374)	—
250	E40	230/240 V, 50 Hz	x	x	30.0 (66)	104.4 (6374)	PCAL25XJB
250	E40	220 Vac, 60 Hz	x	x	30.0 (66)	104.4 (6374)	—
400	E40	230/240 V, 50 Hz	—	x	32.0 (71)	104.4 (6374)	PCAL40XJB
400	E40	220 Vac, 60 Hz	—	x	32.0 (71)	104.4 (6374)	—
600	E40	230/240 V, 50 Hz	—	x	35.0 (77)	104.4 (6374)	PCAL60XJB
600	E40	220 Vac, 60 Hz	—	x	35.0 (77)	104.4 (6374)	—
Mercury Vapor ③							
250	E40	230/240 V, 50 Hz	x	x	30.0 (66)	104.4 (6374)	PCAM25XJB
250	E40	220 Vac, 60 Hz	x	x	30.0 (66)	104.4 (6374)	—
400	E40	230/240 V, 50 Hz	—	x	30.5 (67)	104.4 (6374)	PCAM40XJB
400	E40	220 Vac, 60 Hz	—	x	30.5 (67)	104.4 (6374)	—
Metal Halide ③							
250	E40	230/240 V, 50 Hz	x	x	30.0 (66)	104.4 (6374)	PCAH25XJB
250	E40	220 Vac, 60 Hz	x	x	30.0 (66)	104.4 (6374)	—
400	E40	230/240 V, 50 Hz	—	x	32.0 (71)	104.4 (6374)	PCAH40XJB
400	E40	220 Vac, 60 Hz	—	x	32.0 (71)	104.4 (6374)	—
Halogen							
500/1000	E40	—	—	x	27.0 (60)	104.4 (6374)	PCAZ50B

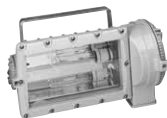

Appleton®

HID/FLOODLIGHT: ATEX/IECEX FLAMEPROOF

Note: Floodlights supplied with hinged mounting bracket, 1 plug, 1 M20 cable gland — 6.5 mm to 14.5 mm (0.26 in to 0.57 in) diameter. Lamps are not included.

① Terminal block with 2 more terminals for wiring with 3 phases plus Neutral in 380/415 V: add suffix **-T** at the end of the catalog number. Certified for use in ATEX/IECEX governed locations only.

② Asymmetrical light distribution is available, add suffix **-A** to end of catalog number. Certified for use in ATEX/IECEX governed locations only.



③ Mercury vapor and metal halide luminaires are not available for purchase within the United States. Please check with your countries governing legislation regarding allowable lamp types before ordering.

ATX™ PC Series Floodlights

Flameproof. Metal Halide, High Pressure Sodium, Mercury Vapor, Halogen

ATEX/IECEX:
 Zone 1 and 2 - 21 and 22
 II 2 GD
 IP66/67 – IK10

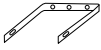
Accessories

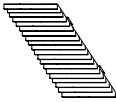
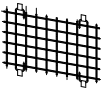
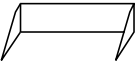
		Catalog Number
Standard Galvanized Steel Hinged Mounting Bracket Replacement Part		
		PCHBG
Optional Galvanized Steel Mounting Brackets		
		1-1/4" to 1-1/2"
Pole/Tube	Flat Surface	PCHC49G
Flat Surface Mounting		2"
		PCHC60G
400 W Mercury Vapor Lamp		PCSBG
		LM400E40
Screwed-on Overhead Diffuser		
		PCGDG
Screwed-on Protective Guard		
		PCPGZ
Visor – Secured With 2 Screws		
		PCVG

Dimensions in Millimeters (Inches)

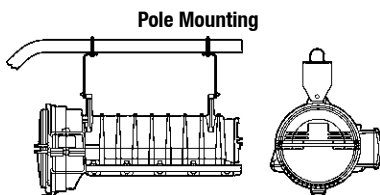
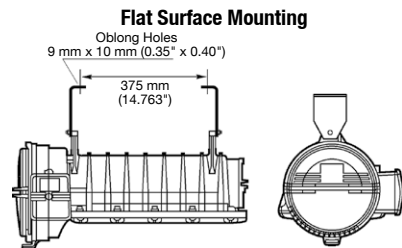
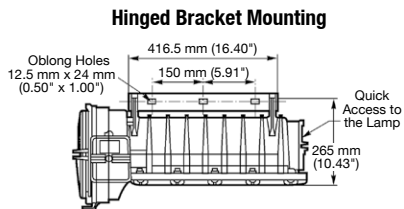

ATX™ PC Series Floodlights

Flameproof. Metal Halide, High Pressure Sodium, Mercury Vapor, Halogen

ATEX/IECEX:
 Zone 1 and 2 - 21 and 22
 II 2 GD
 IP66/67 - IK10

Photometric Data

Polar curves for a 1000 lm flux, according to NF C 71-120
 Luminaire symbol according to NF C 71-121

--- Longitudinal
 — Transverse

Narrow beam Metal Halide 250 W
 Efficiency 68.3%
 NF C 71-121: 0.68B

CANDELA DISTRIBUTION

0-180 90-270

0	505	505
5	515	499
10	512	469
15	501	403
20	476	312
25	453	248
30	427	190
35	394	146
40	368	117
45	290	97
50	160	12
55	51	7
60	34	4
65	15	4
70	6	4

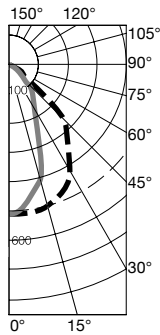

Narrow beam Metal Halide 400 W ①
 Efficiency 49.3%
 NF C 71-121: 0.49C

CANDELA DISTRIBUTION

0-180 90-270

0	217	217
5	210	219
10	218	231
15	223	205
20	238	193
25	255	148
30	266	132
35	263	130
40	244	116
45	201	104
50	136	37
55	85	15
60	51	8
65	28	6
70	5	4

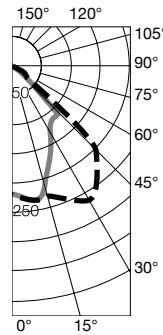

Narrow beam Halogen 1000 W
 Efficiency 59.2%
 NF C 71-121: 0.59B

CANDELA DISTRIBUTION

0-180 90-270

0	417	417
5	406	418
10	419	399
15	419	330
20	408	266
25	398	218
30	371	177
35	344	142
40	295	115
45	213	98
50	135	12
55	68	7
60	34	4
65	16	3
70	5	3

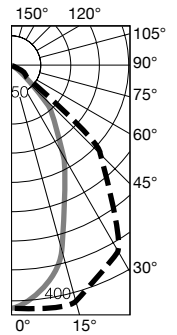

Wide beam Metal Halide 250 W
 Efficiency 67.9%
 NF C 71-121: 0.68C

CANDELA DISTRIBUTION

0-180 90-270

0	301	301
5	303	318
10	299	342
15	294	387
20	287	382
25	286	306
30	271	237
35	231	208
40	172	186
45	133	140
50	83	104
55	48	18
60	34	8
65	23	6
70	6	6

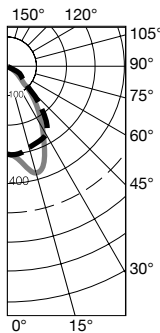

Wide beam Metal Halide 400 W ①
 Efficiency 46.7%
 NF C 71-121: 0.46C

CANDELA DISTRIBUTION

0-180 90-270

0	105	105
5	104	106
10	108	130
15	124	165
20	148	177
25	167	183
30	165	147
35	142	127
40	116	113
45	74	115
50	52	103
55	48	40
60	44	13
65	34	9
70	18	6

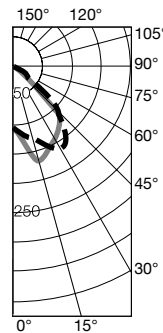

Wide beam Halogen 1000 W
 Efficiency 57.7%
 NF C 71-121: 0.57C

CANDELA DISTRIBUTION

0-180 90-270

0	251	251
5	244	255
10	247	272
15	245	293
20	237	306
25	229	262
30	213	213
35	194	188
40	163	161
45	120	133
50	82	105
55	52	18
60	35	8
65	20	5
70	8	5

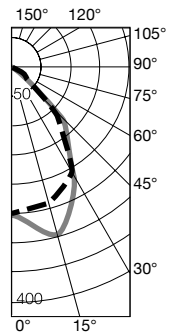

① 400 W Metal Halide: Efficiency rate lower than 250 W due to thermal deflector between glass and lamp, requested for T3.

ATX™ PL Series Floodlights

Flameproof. Metal Halide, High Pressure Sodium, Mercury Vapor, Halogen

ATEX/IECEX:
Zone 1 and 2 - 21 and 22
Ex II 2 GD
IP66/67 - IK10

Applications

- Designed for large area lighting in industrial outdoor and indoor hazardous areas.
- Ideal for use in Zones 1 and 2 and 21 and 22 in the oil and gas industry. In locations such as: refineries, pipelines, warehouses, offshore platforms and drilling rigs.

Features

- Gray epoxy painted light marine grade aluminum housing and door.
- The cover is fitted with a short safety chain.
- Lampholder can be easily field-adjustable for either a narrow or wide beam.
- Fixtures operate safely in high ambient temperatures up to +55 °C (+131 °F) and in low ambient temperature up to -40 °C (-40 °F).
- Electrical components (ballast, ignitor and capacitor) are thermally separated from the lighting compartment with an insulating protection, providing extended life.
- Easy and efficient wiring due to separate Ex e terminal box with wiring onto 2 captive terminals 2 x 6 mm² (2 x 0.009 in²); 2 internal earth terminals capacity 4 mm² (0.009 in²) and 1 external earth terminal capacity 4 mm² (0.006 in²).
- 2 x 20 mm (2 x 0.79 in) clearance holes throughwire cable entries supplied with:
 - One Ex e unarmored cable gland — 6.5 mm to 14.5 mm (0.2 in to 0.57 in) sealing diameter.
 - One blanking plug.
 - Two M20 locknuts.
- For use with either tubular or ellipsoidal shape lamps. See ordering information for details.
- Choice of mounting with galvanized hinged bracket fixed mounting or tube/pole mounting with galvanized brackets.
- Thermoshock and impact-resistant glass factory sealed into the cover frame.
- Operates in wall-mounting or down lighting applications.
- Reversible hinge allows for fixture access from either side.
- E40 or H3 lampholders for the 2 x 70 W Vac/Vdc halogen version.
- Internal symmetric reflector.

Standard Materials

- Housing and door: copperfree marine-grade aluminum alloy
- Lens: toughened safety glass
- Reflector: bright highly polished aluminum
- Bolts: stainless steel bolt
- Cable gland and blanking plug: polyamide
- Locknut: nickel plated brass

Standard Finishes

- Housing and door: gray epoxy powder paint

Options

- 1000 W HP Sodium with separate Ex d housing for ballast.
- Other voltages, please contact your sales representative.
- Hinged bracket available: add suffix **-B** at the end of the catalog number.
- Terminal block with 2 more terminals for wiring with 3 phases plus Neutral in 380/415 V (loop in/loop out wiring possible): add suffix **-T** at the end of the catalog number.



- Asymmetrical light distribution is available, add suffix **-A** to end of catalog number.
- Screwed-on overhead diffuser out of galvanized steel with black painting (see accessories).
- Screwed-on zinc-coated protection guard (see accessories).

ATEX/IECEX Certifications and Compliances

- Certification Type: P, Jd
 - Gas: Zone 1 and 2
 - Conforming to ATEX 94/9/CE: Ex II 2 G
 - Type of Protection: Ex de IIB
 - Temperature Class: See *T Rating (Gas) and Surface Temperature (Dust) Table*
 - Dust: Zone 21 - 22
 - Conforming to ATEX 94/9/CE: Ex II 2 D
 - Type of Protection: Ex tD A21
 - Surface Temperature: See *T Rating (Gas) and Surface Temperature (Dust) Table*
- Ambient Temperature: -40 °C ≤ Ta ≤ +55 °C (-40 °F ≤ Ta ≤ +131 °F)
- CE Declaration of Conformity: 50207
- ATEX Certificate: LCIE 99/ ATEX 6002
- IECEx Certificate: IECEx LCI 04.0020
- Index of Protection according EN/IEC 60529: IP66/67
- Impact Resistance (shock): IK10

EURASEC Certification

- EURASEC N° TC RU C-FR.Г505.B.00912

Other Certification

- INMETRO Certificate: BVC12.2098 ①

① Inmetro certification available on special request only. Contact your local sales representative for more information.

ATX™ PL Series Floodlights

Flameproof. Metal Halide, High Pressure Sodium, Mercury Vapor, Halogen

ATEX/IECEX:
Zone 1 and 2 - 21 and 22
Ⓢ II 2 GD
IP66/67 – IK10

Order using catalog numbering guide below or select catalog number from the following pages.

Catalog Numbering Guide – PL Series Floodlights

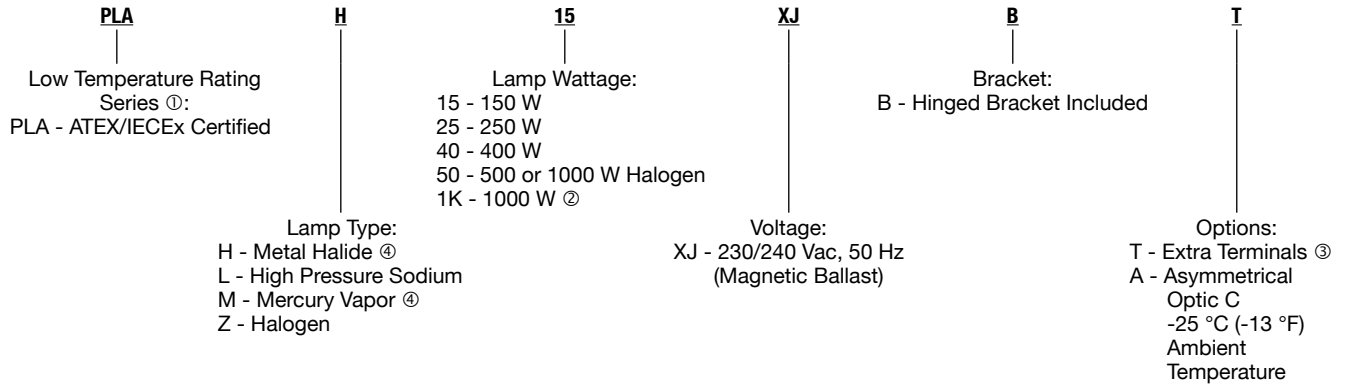

T Rating (Gas) and Surface Temperature (Dust) Table

Lamp Type and Wattage	Gas Temperature Rating According to Ta			Dust Surface Temperature °C (°F)
	+40 °C (+104°F)	+50 °C (+122°F)	+55 °C (+131°F)	
150 W High Pressure Sodium	T4	T3	T3	+145 (+293)
250 W High Pressure Sodium	T4	T3	T3	+145 (+293)
250 W Metal Halide	T3	T3	T3	+197 (+387)
250 W Mercury Vapor	T3	T3	T3	+194 (+381)
400 W High Pressure Sodium	T4	T3	T3	+144 (+291)
400 W Metal Halide	T3	T3	T3	+193 (+379)
400 W Mercury Vapor	T3	T3	T3	+195 (+383)
600 W High Pressure Sodium	T2	T2	T2	+257 (+495)
500 W Halogen	T2	T2	T2	+267 (+513)
1000 W Halogen	T1	T1	T1	+378 (+712)

① Only for 250 W and 400 W Versions.

② Available for High Pressure Sodium Lamp Only + Separate Gear Box.

③ 3 Phase + Neutral.

④ Mercury vapor and metal halide luminaires are not available for purchase within the United States. Please check with your countries governing legislation regarding allowable lamp types before ordering.



ATX™ PL Series Floodlights

Flameproof. Metal Halide, High Pressure Sodium, Mercury Vapor, Halogen

ATEX/IECEX:
Zone 1 and 2 - 21 and 22
II 2 GD
IP66 or IP66/67 – IK10

Lamp Wattages	Lampholder	Voltage (+/-10%)	Lamp Type		Weight kg (lb)	Volume dm ³ (in ³)	Catalog Number ① ② ③
			Ellipsoidal	Tubular			
High Pressure Sodium							
250	E40	230/240 V 50 Hz	x	x	37.5 (83)	104.4 (6374)	PLAL25XJB
400	E40	220 V 50 Hz	x	x	37.5 (83)	104.4 (6374)	PLAL40XAB
Halogen							
500/1000	E40		-	x	34.0 (75)	104.4 (6374)	PLAZ50B

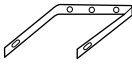
Accessories and Replacement Parts

							Catalog Number
Galvanized Steel Hinged Brackets							
							PCHBG
Galvanized Steel Brackets							
		Pole/Tube Mounting		1-1/4" to 1-1/2"		PNHC49G	
		Flat Surface Mounting		2"		PNHC60G	
Pole/Tube	Flat Surface	Flat Surface Mounting				PNSBG	
400 W Mercury Vapor Lamp							LM400E40

Dimensions in Millimeters (Inches)

Hinged Bracket Mounting

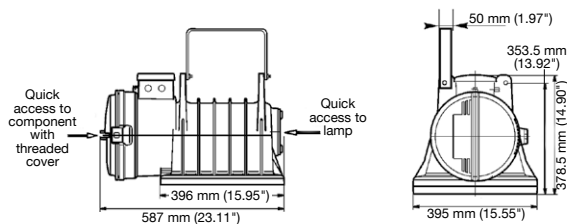

Flat Surface Mounting

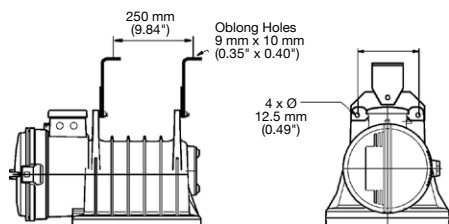

Pole Mounting

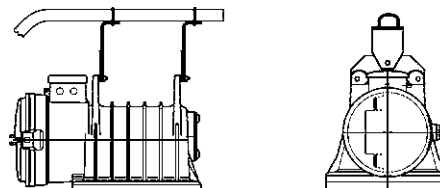

Note: Floodlights supplied with hinged mounting bracket, 1 plug, 1 M20 cable gland — diameter 6.5 mm to 14.5 mm (0.26 in to 0.57 in). Lamps are not included.

- ① Hinged bracket available: add suffix **-B** at the end of the catalog number.
- ② Terminal block with 2 more terminals for wiring with 3 phases plus Neutral in 380/415 V: add suffix **-T** at the end of the catalog number.
- ③ Asymmetrical light distribution is available, add suffix **-A** to end of catalog number.

ATX™ PL Series Floodlights

Flameproof. Metal Halide, High Pressure Sodium, Mercury Vapor, Halogen

ATEX/IECEX:
 Zone 1 and 2 - 21 and 22
 II 2 GD
 IP66 or IP66/67 - IK10

Photometric Data

Polar curves for a 1000 lm flux, according to NF C 71-120
 Luminaire symbol according to NF C 71-121

--- Longitudinal
 — Transverse

Narrow beam Metal Halide 250 W
 Efficiency 68.3%
 NF C 71-121: 0.68B

CANDELA DISTRIBUTION

	0-180	90-270
0	505	505
5	515	499
10	512	469
15	501	403
20	476	312
25	453	248
30	427	190
35	394	146
40	368	117
45	290	97
50	160	12
55	51	7
60	34	4
65	15	4
70	6	4

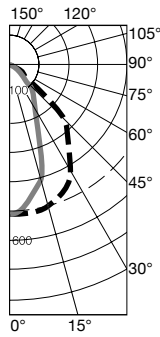

Narrow beam Metal Halide 400 W ①
 Efficiency 49.3%
 NF C 71-121: 0.49C

CANDELA DISTRIBUTION

	0-180	90-270
0	217	217
5	210	219
10	218	231
15	223	205
20	238	193
25	255	148
30	266	132
35	263	130
40	244	116
45	201	104
50	136	37
55	85	15
60	51	8
65	28	6
70	5	4

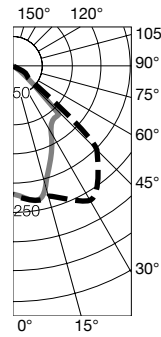

Narrow beam Halogen 1000 W
 Efficiency 59.2%
 NF C 71-121: 0.59B

CANDELA DISTRIBUTION

	0-180	90-270
0	417	417
5	406	418
10	419	399
15	419	330
20	408	266
25	398	218
30	371	177
35	344	142
40	295	115
45	213	98
50	135	12
55	68	7
60	34	4
65	16	3
70	5	3

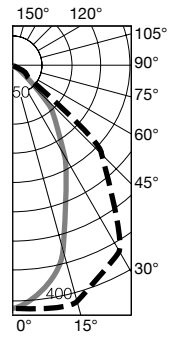

Wide beam Metal Halide 250 W
 Efficiency 67.9%
 NF C 71-121: 0.68C

CANDELA DISTRIBUTION

	0-180	90-270
0	301	301
5	303	318
10	299	342
15	294	387
20	287	382
25	286	306
30	271	237
35	231	208
40	172	186
45	133	140
50	83	104
55	48	18
60	34	8
65	23	6
70	6	6

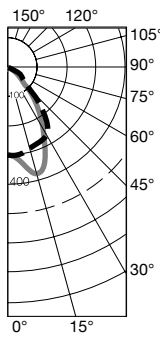

Wide beam Metal Halide 400 W ①
 Efficiency 46.7%
 NF C 71-121: 0.46C

CANDELA DISTRIBUTION

	0-180	90-270
0	105	105
5	104	106
10	108	130
15	124	165
20	148	177
25	167	183
30	165	147
35	142	127
40	116	113
45	74	115
50	52	103
55	48	40
60	44	13
65	34	9
70	18	6

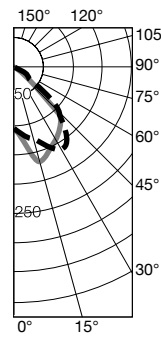

Wide beam Halogen 1000 W
 Efficiency 57.7%
 NF C 71-121: 0.57C

CANDELA DISTRIBUTION

	0-180	90-270
0	251	251
5	244	255
10	247	272
15	245	293
20	237	306
25	229	262
30	213	213
35	194	188
40	163	161
45	120	133
50	82	105
55	52	18
60	35	8
65	20	5
70	8	5

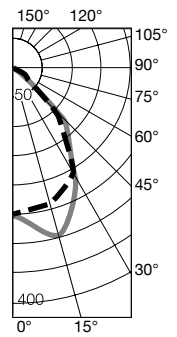

① 400 W Metal Halide: Efficiency rate lower than 250 W due to thermal deflector between glass and lamp, requested for T3.

HID/FLOODLIGHT: ATEX/IECEX FLAMEPROOF

ATX™ PB Series Floodlights

Flameproof. Metal Halide, Sodium, Mercury Vapor, Halogen

NEC/CEC:
AEx/Ex de IIB IP 66
Ex de IIB
IP66

ATEX/IECEX:
Zone 1 and 2 - 21 and 22
⊕ II 2 GD
IP66 - IK10

Applications

- Designed for large area lighting in industrial outdoor and indoor hazardous areas.
- Ideal for use in Zones 1 and 2 and 21 and 22 in the oil and gas industry. In locations such as: refineries, pipelines, warehouses, offshore platforms and drilling rigs.

Features

- Gray epoxy painted light marine grade aluminum housing and door.
- Fast and easy lamp replacement via threaded cover on the side of the fixture. The cover is fitted with a short safety chain.
- Lampholder can be easily field-adjustable for either a narrow or wide beam.
- Fixtures operate safely in high ambient temperatures up to +55 °C (+131°F) and in low ambient temperature up to -40 °C (-40 °F).
- Electrical components (ballast, ignitor and capacitor) are thermally separated from the lighting compartment with a bulkhead, providing extended life.
- Easy and efficient wiring due to separate Ex e terminal box with wiring onto 2 captive terminals 2 x 6 mm² (2 x 0.009 in²); 2 internal earth terminals capacity 6 mm² (0.009 in²) and 1 external earth terminal capacity 4 mm² (0.006 in²).
- 2 x 20 mm (2 x 0.79 in) clearance holes throughwire cable entries supplied with:
 - One Ex e unarmored cable gland — sealing diameter 6.5 mm to 14.5 mm (0.2 in to 0.57 in)
 - One blanking plug
 - Two M20 locknuts
- For use with either tubular or ellipsoidal shape lamps. See ordering information for details.
- Choice of mounting with galvanized hinged bracket fixed mounting or tube/pole mounting with galvanized brackets.
- Thermoshock and impact-resistant glass factory sealed into the cover frame.
- Operates in any position.
- Reversible hinge allows for fixture access from either side.
- E40 or H3 lampholders for the 2 x 70 W Vac/Vdc halogen version.
- Internal symmetric reflector.

Standard Materials

- Housing and door: copperfree marine-grade aluminum alloy
- Lens: toughened safety glass
- Reflector: bright highly polished aluminum
- Bolts: stainless steel bolt
- Cable gland and blanking plug: polyamide
- Locknut: nickel plated brass

Standard Finishes

- Housing and door: gray epoxy powder paint

Options

- Other voltages, please contact your sales representative.
- Hinged bracket available: add suffix -T at the end of the catalog number.
- Terminal block with 2 more terminals for wiring with 3 phases plus Neutral in 380/415 V (loop in/loop out wiring possible): add suffix -T at the end of the catalog number.

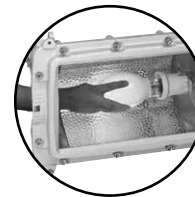
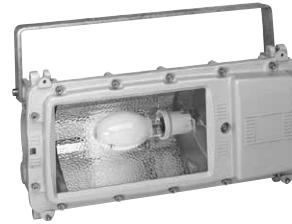

- Asymmetrical light distribution is available, add suffix -A to end of catalog number.
- Screwed-on overhead diffuser out of galvanized steel with black painting (see accessories).
- Screwed-on zinc-coated protection guard (see accessories).

NEC/CEC Certifications and Compliances

- AEx/Ex de IIB IP 66
- cCSAus Ex de IIB IP 66
- 175 W Metal Halide and Pulse Start Metal Halide
- Safety starter

ATEX/IECEX Certifications and Compliances

- Certification Type: PjD
 - Gas: Zone 1 and 2
 - Conforming to ATEX 94/9/CE: ⊕ II 2 G
 - Type of Protection: Ex de IIB
 - Temperature Class: See *T Rating (Gas) and Surface Temperature (Dust) Table*
 - Dust: Zone 21 - 22
 - Conforming to ATEX 94/9/CE: ⊕ II 2 D
 - Type of Protection: Ex tD A21
 - Surface Temperature: See *T Rating (Gas) and Surface Temperature (Dust) Table*
- Ambient Temperature: -20 °C ≤ Ta ≤ +55 °C (-4 °F ≤ Ta ≤ +131 °F)
- CE Declaration of Conformity: 50207
- ATEX Certificate: LCIE 99/ ATEX 6002
- IECEx Certificate: IECEx LCI 04.0020
- Index of Protection according EN/IEC 60529: IP66 (Type PB)
- Impact Resistance (shock): IK10

EURASEC Certification

- EURASEC N° TC RU C-FR.Г505.B.00912

ATX™ PB Series Floodlights

Flameproof. Metal Halide, High Pressure Sodium, Mercury Vapor, Halogen

NEC/CEC:
AEx/Ex de IIB IP 66
Ex de IIB
IP66

ATEX/IECEX:
Zone 1 and 2 - 21 and 22
II 2 GD
IP66 - IK10

Order using catalog numbering guide below or select catalog number from the following pages.

Catalog Numbering Guide — PB Series Floodlights

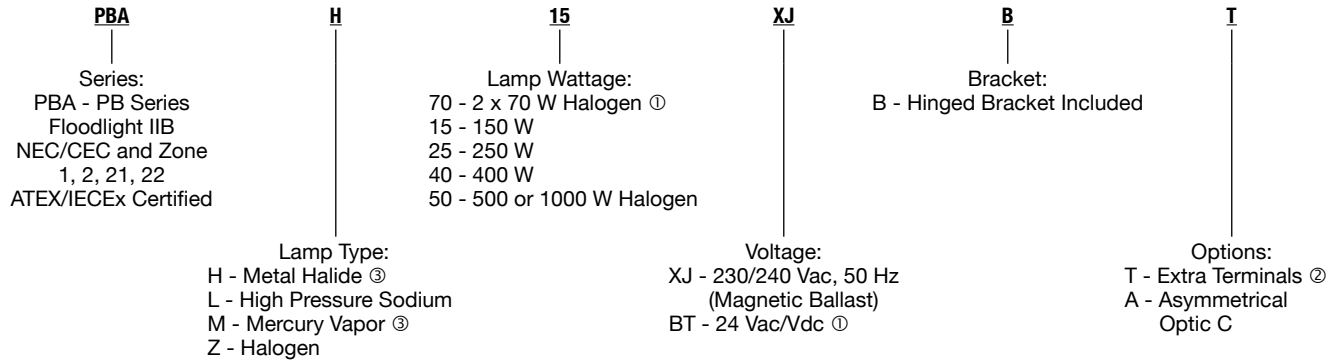

HID/FLOODLIGHT: NEC/CEC, ATEX/IECEX FLAMEPROOF

T Rating (Gas) and Surface Temperature (Dust) Table

Lamp Type and Wattage	Gas Temperature Rating According to Ta			Dust Surface Temperature °C (°F)
	+40 °C (+104°F)	+50 °C (+122°F)	+55 °C (+131°F)	
2 x 70 W - H3 ①	T4	T4	T4	+130 (+266)
150 W High Pressure Sodium	T4	T3	T3	+145 (+293)
250 W High Pressure Sodium	T3	T3	T3	+195 (+383)
250 W Metal Halide	T3	T3	T3	+197 (+387)
250 W Mercury Vapor	T3	T3	T3	+194 (+381)
400 W High Pressure Sodium	T3	T3	T3	+189 (+372)
400 W Metal Halide	T3	T3	T3	+193 (+379)
400 W Mercury Vapor	T3	T3	T3	+195 (+383)
600 W High Pressure Sodium	T2	T2	T2	+257 (+495)
500 W Halogen	T2	T2	T2	+267 (+513)
1000 W Halogen	T1	T1	T1	+378 (+712)

① 2 x 70 W Halogen 24 Vac/Vdc.

② 3 Phase + Neutral.

③ Mercury vapor and metal halide luminaires are not available for purchase within the United States. Please check with your countries governing legislation regarding allowable lamp types before ordering.

ATX™ PB Series Floodlights

Flameproof. Metal Halide, High Pressure Sodium, Mercury Vapor, Halogen

NEC/CEC:
AEx/Ex de IIB IP 66
Ex de IIB
IP 66

ATEX/IECEx:
Zone 1 and 2 - 21 and 22
II 2 GD
IP66 or IP66/67 - IK10

HID/FLOODLIGHT: NEC/CEC, ATEX/IECEx FLAMEPROOF

Lamp Wattages	Lampholder	Voltage (+/-10%)	Lamp Type		Weight kg (lb)	Volume dm ³ (in ³)	Catalog Number ② ③
			Ellipsoidal	Tubular			
High Pressure Sodium							
150	E40	230/240 V, 50 Hz	x	x	29.3 (65)	79.4 (4847)	PBAL15XJB
250	E40	230/240 V, 50 Hz	x	x	30.3 (67)	79.4 (4847)	PBAL25XJB
400	E40	230/240 V, 50 Hz	-	x	31.8 (70)	79.4 (4847)	PBAL40XJB
Mercury Vapor ④							
250	E40	230/240 V, 50 Hz	x	x	29.3 (65)	79.4 (4847)	PBAM25XJB
400	E40	230/240 V, 50 Hz	-	x	29.8 (66)	79.4 (4847)	PBAM40XJB
Metal Halide							
250	E40	230/240 V, 50 Hz	x	x	30.3 (67)	79.4 (4847)	PBAH25XJB
400	E40	230/240 V, 50 Hz	-	x	31.8 (70)	79.4 (4847)	PBAH40XJB
Halogen ④							
500/1000	E40	-	-	x	26.3 (58)	79.4 (4847)	PBAZ50B
2 x 70	H3	24 Vac/Vdc, 50 Hz	-	-	27.3 (60)	79.4 (4847)	PBAZ70BTB ①



Accessories

Galvanized Steel Hinged Brackets

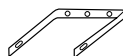

PBHBG

Pole/Tube Mounting Galvanized Steel Brackets



1-1/4" to 1-1/2"

PNHC49G

2"

PNHC60G

Flat Surface Mounting Galvanized Steel Brackets



PNSBG

400 W Mercury Vapor Lamp

LM400E40

Screwed-on Overhead Diffuser

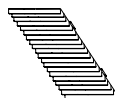

PBGDG

Screwed-on Protective Guard



PBPGZ

Note : Floodlights supplied with hinged mounting bracket, 1 plug, 1 M20 cable gland — 6.5 mm to 14.5 mm (0.26 in to 0.57 in) diameter. Lamps are not included.

① Supplied with 2 x 70 W H3 bulbs, 24 Vac/Vdc.

② Terminal block with 2 more terminals for wiring with 3 phases plus Neutral in 380/415 V: add suffix **-T** at the end of the catalog number.

③ Asymmetrical light distribution is available, add suffix **-A** to end of catalog number.

④ Mercury vapor and metal halide luminaires are not available for purchase within the United States. Please check with your countries governing legislation regarding allowable lamp types before ordering.

ATX™ PB Series Floodlights

Flameproof. Metal Halide, High Pressure Sodium, Mercury Vapor, Halogen

NEC/CEC:
AEx/Ex de IIB IP 66
Ex de IIB
IP66

ATEX/IECEx:
Zone 1 and 2 - 21 and 22
II 2 GD
IP66 - IK10

Dimensions in Millimeters (Inches)

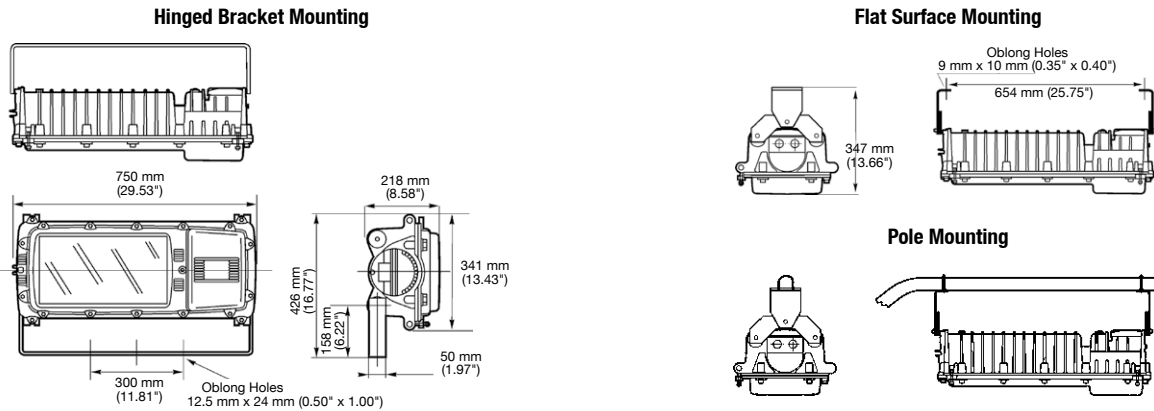

Photometric Data

Polar curves for a 1000 lm flux, according to NF C 71-120
Luminaire symbol according to NF C 71-121

--- Longitudinal
— Transverse

Narrow beam Metal Halide 250 W
Efficiency 68.3%
NF C 71-121: 0.68B

CANDELA DISTRIBUTION

0-180 90-270

	0	150°	120°	105°
0	505	505		
5	515	499		
10	512	469		
15	501	403		
20	476	312		
25	453	248		
30	427	190		
35	394	146		
40	368	117		
45	290	97		
50	160	12		
55	51	7		
60	34	4		
65	15	4		
70	6	4		

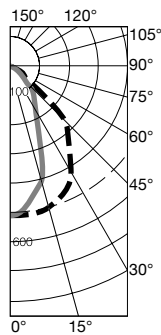

Narrow beam Metal Halide 400 W ①
Efficiency 49.3%
NF C 71-121: 0.49C

CANDELA DISTRIBUTION

0-180 90-270

	0	150°	120°	105°
0	217	217		
5	210	219		
10	218	231		
15	223	205		
20	238	193		
25	255	148		
30	266	132		
35	263	130		
40	244	116		
45	201	104		
50	136	37		
55	85	15		
60	51	8		
65	28	6		
70	5	4		

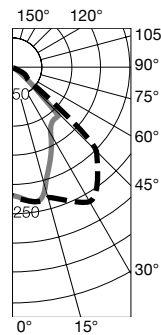

Narrow beam Halogen 1000 W
Efficiency 59.2%
NF C 71-121: 0.59B

CANDELA DISTRIBUTION

0-180 90-270

	0	150°	120°	105°
0	417	417		
5	406	418		
10	419	399		
15	419	330		
20	408	266		
25	398	218		
30	371	177		
35	344	142		
40	295	115		
45	213	98		
50	135	12		
55	68	7		
60	34	4		
65	16	3		
70	5	3		

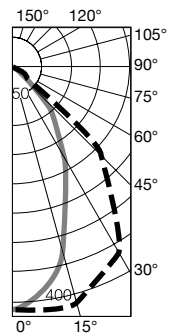

Wide beam Metal Halide 250 W
Efficiency 67.9%
NF C 71-121: 0.68C

CANDELA DISTRIBUTION

0-180 90-270

	0	150°	120°	105°
0	301	301		
5	303	318		
10	299	342		
15	294	387		
20	287	382		
25	286	306		
30	271	237		
35	231	208		
40	172	186		
45	133	140		
50	83	104		
55	48	18		
60	34	8		
65	23	6		
70	6	6		

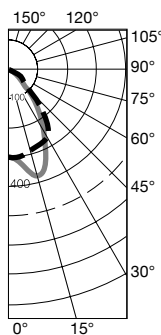

Wide beam Metal Halide 400 W ①
Efficiency 46.7%
NF C 71-121: 0.46C

CANDELA DISTRIBUTION

0-180 90-270

	0	150°	120°	105°
0	105	105		
5	104	106		
10	108	130		
15	124	165		
20	148	177		
25	167	183		
30	165	147		
35	142	127		
40	116	113		
45	74	115		
50	52	103		
55	48	40		
60	44	13		
65	34	9		
70	18	6		

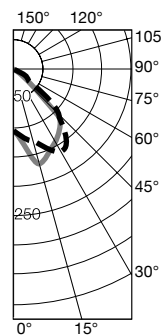

Wide beam Halogen 1000 W
Efficiency 57.7%
NF C 71-121: 0.57C

CANDELA DISTRIBUTION

0-180 90-270

	0	150°	120°	105°
0	251	251		
5	244	255		
10	247	272		
15	245	293		
20	237	306		
25	229	262		
30	213	213		
35	194	188		
40	163	161		
45	120	133		
50	82	105		
55	52	18		
60	35	8		
65	20	5		
70	8	5		

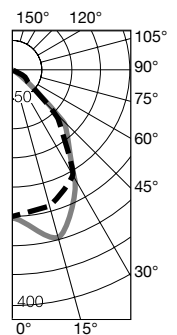

① 400 W Metal Halide: Efficiency rate lower than 250 W due to thermal deflector between glass and lamp, requested for T3.

Areamaster™ 250/400 Integrally Ballasted Floodlights

175 W to 400 W HID

For ordinary locations. NOT available for use in CEC governed locations.

NEC:
Rated for Ordinary (Unclassified) Locations

Applications

- Powerful, efficient lighting for medium and large areas such as:
 - Shopping malls
 - Parking lots
 - Sports areas
 - New car lot lighting
 - Security lighting
 - Industrial process lighting

Features

- Compact in size, attractively styled contemporary design, rugged and dependable.
- Easy to install and service.
- A wide range of ballasts and voltages are available for both domestic and export applications.
- Integral ballast.
- One-piece housing.
- One-piece lens cover. Secured by four 1/4" Dia. captive stainless steel slotted hex-head bolts.
- Thermal shock and impact resistant glass lens.
- Heavy duty, high temperature silicone rubber gasket, firmly seated.
- Heavy duty mogul-base porcelain socket with heavy gauge brass, nickel-plated, double lamp-grip screw shell and springloaded center contact.
- Compound parabolic, double segment, finished aluminum reflector for optimum efficiency.
- Mounting choice:
 - (1) Yoke mount, zinc plated steel yoke with architectural bronze polyester finish
 - (2) Pole mount, built-in slip-fitter, for internal wiring, adjustable laterally and vertically, slip fits 50.8 mm (2.00") thru 63.5 mm (2.50") 2" or 2-1/2" pipe, architectural bronze polyester finish available for use in CEC governed locations
- Cool operating temperatures translate into long luminaire life.

Standard Materials

- Ballast housing and lens door: copperfree (4/10 of 1% max.) aluminum
- Gasket: silicone rubber
- Socket: heavy duty porcelain with heavy gauge brass shell
- Reflector: finished aluminum
- Yoke mount: zinc plated steel
- Bolts: stainless steel

Standard Finishes

- Ballast housing, lens cover, yoke and pole mount: architectural bronze polyester
- Socket: nickel-plated

NEC/CEC Certifications and Compliances

- UL Standard: 844, 1598, 1598A



Areamaster with Integral Pole Slip-fit

Dimensions in Millimeters (Inches)

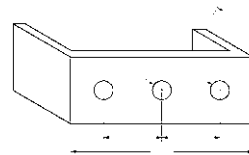
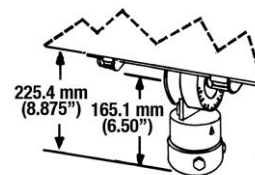
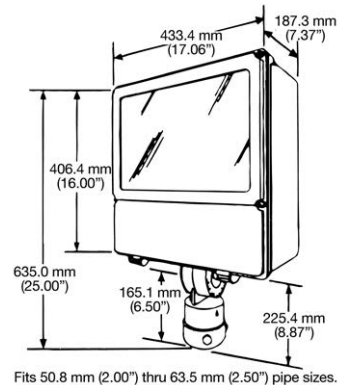

HID/FLOODLIGHT: NEC/CEC ORDINARY LOCATION

Appleton

Areamaster™ 250/400 Integrally Ballasted Floodlights

175 W to 400 W HID

For ordinary locations. NOT available for use in CEC governed locations.

NEC:

Rated for Ordinary (Unclassified) Locations

Order using catalog numbering guide below or select catalog number from tables on following pages.

Catalog Numbering Guide For Areamaster 250/400 Floodlights

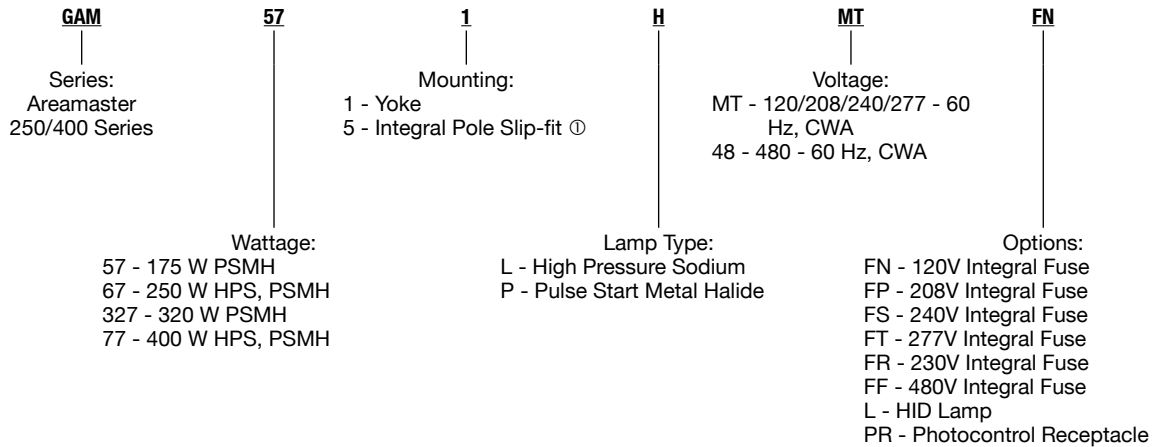

Lamp	Line Voltage	Weight kg (lb)	Volume dm ³ (in ³)	Catalog Number	
				Yoke Mount	Slip-Fit Mount ①
High Pressure Sodium					
250 W HPS	120/208/240/277	14.3 (31.5)	62.5 (3814)	G-AM671L-MT	G-AM675L-MT
	480			G-AM671L-48	G-AM675L-48
400 W HPS	120/208/240/277	16.0 (35.3)	62.5 (3814)	G-AM771L-MT	G-AM775L-MT
	480			G-AM771L-48	G-AM775L-48
Pulse Start Metal Halide					
175 W PSMH	120/208/240/277	12.9 (28.4)	62.5 (3814)	G-AM571P-MT	G-AM575P-MT
	480			G-AM571P-48	G-AM575P-48
250 W PSMH	120/208/240/277	14.3 (31.5)	62.5 (3814)	G-AM671P-MT	G-AM675P-MT
	480			G-AM671P-48	G-AM675P-48
320 W PSMH	120/208/240/277	16.0 (35.3)	62.5 (3814)	G-AM3271P-MT	G-AM3275P-MT
	480			G-AM3271P-48	G-AM3275P-48
400 W PSMH	120/208/240/277	16.0 (35.3)	62.5 (3814)	G-AM771P-MT	G-AM775P-MT
	480			G-AM771P-48	G-AM775P-48







① Slip-fits 2" or 2-1/2" pipe-size tenons.

Areamaster™ 250/400 Integrally Ballasted Floodlights

175 W to 400 W HID

For ordinary locations. NOT available for use in CEC governed locations.

NEC:
Rated for Ordinary (Unclassified) Locations

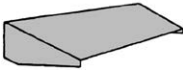
	Description	Catalog Numbers
Crossarm Mounting Bracket		
	Has 180° horizontal adjustment — degree marked. Facilitates mounting floodlight to crossarm or other flat surface, or to G-AM-8-WB. Includes floodlight yoke bolts. Malleable iron, zinc plated, chromate sealed, architectural bronze polyester finish.	G-AM-8-CA
Pipe or Wall Mount Bracket		
	Used with G-AM-8-CA. Clamps to 1" to 2-1/2" pipe, vertical or horizontal, or mounts on flat surfaces. Includes U-bolt and crossarm bracket bolts. Malleable iron, zinc plated, chromate sealed, with architectural bronze polyester finish.	G-AM-8-WB
Poletop Slip-Fitter		
	Slip-fits 1-1/2" or 2" pipe size poletop tenons. Includes floodlight yoke bolts, 3 locking bolts, and cord grip. Body is malleable iron-zinc plated, chromate sealed, with cast aluminum cap. Assembly has architectural bronze polyester finish.	G-SF20
	Slip-fits 2" or 2-1/2" poletop tenons. Includes floodlight yoke bolts, 3 locking bolts, and cord grip. Malleable iron, zinc plated, chromate sealed, with architectural bronze polyester finish.	G-AM-8-SF
Locking-Type Photocontrol Receptacle		
	For NEMA type photocontrol, with installation hardware and instructions.	G-1PCR
Vandal Shield		
	UV stabilized polycarbonate, with installation hardware and instructions.	G-AM-6-VS
Top Visor		
	Easy to install with hardware supplied. Aluminum, with architectural bronze polyester finish.	G-AM-6-V

HID/FLOODLIGHT: NEC/CEC ORDINARY LOCATION

Appleton®

Areamaster™ 250/400 Integrally Ballasted Floodlights

175 W to 400 W HID

For ordinary locations. NOT available for use in CEC governed locations.

NEC:

Rated for Ordinary (Unclassified) Locations

Line Voltage	Frequency	Type of Ballast	Starting Amps	Operating Amps	Total Watts
250 Watt High Pressure Sodium					
120	60	CWA	2.00	2.50	295
208	60	CWA	1.20	1.50	295
240	60	CWA	1.00	1.30	295
277	60	CWA	0.85	1.10	295
480	60	CWA	0.40	0.65	295
400 Watt High Pressure Sodium					
120	60	CWA	3.30	3.80	465
208	60	CWA	1.80	2.20	465
240	60	CWA	1.60	1.90	465
277	60	CWA	1.40	1.70	465
480	60	CWA	0.80	1.00	465
175 Watt Pulse Start Metal Halide					
120	60	Super CWA	0.90	1.78	199
208	60	Super CWA	0.50	1.08	199
240	60	Super CWA	0.35	0.89	199
277	60	Super CWA	0.30	0.76	199
480	60	Super CWA	0.25	0.50	213
250 Watt Pulse Start Metal Halide					
120	60	Super CWA	1.90	2.50	288
208	60	Super CWA	1.10	1.45	288
240	60	Super CWA	0.96	1.25	288
277	60	Super CWA	0.85	1.10	288
480	60	Super CWA	0.45	0.60	285
320 Watt Pulse Start Metal Halide					
120	60	Super CWA	2.60	3.25	368
208	60	Super CWA	1.50	1.90	368
240	60	Super CWA	1.30	1.65	368
277	60	Super CWA	1.15	1.40	368
480	60	Super CWA	0.60	0.80	368
400 Watt Pulse Start Metal Halide					
120	60	Super CWA	3.50	4.00	454
208	60	Super CWA	2.00	2.30	454
240	60	Super CWA	1.25	2.00	454
277	60	Super CWA	1.50	1.75	454
480	60	Super CWA	0.90	1.00	454

Photometric Data

Typical Footcandle Values ♦

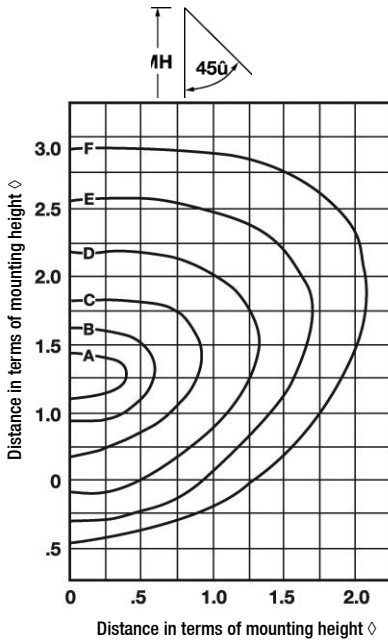

Mtg. Ht. Meters (Feet)	Ft. Cdles for Iso-Footcandle Lines					
	A	B	C	D	E	F
400W HPS						
18.3 m (60')	3.27	2.74	1.82	0.92	0.37	0.18
15.2 m (50')	4.74	4.00	2.90	1.37	0.52	0.27
12.2 m (40')	7.65	6.28	4.38	2.27	0.82	0.43
9.1 m (30')	13.10	10.92	7.83	3.47	1.45	0.77
6.1 m (20')	28.22	25.55	17.37	7.28	3.46	1.82
400W PSMH						
18.3 m (60')	2.60	1.86	1.12	0.65	0.37	0.19
15.2 m (50')	3.72	2.60	1.66	0.85	0.54	0.28
12.2 m (40')	6.14	4.05	2.60	1.49	0.84	0.40
9.1 m (30')	10.96	8.74	4.46	2.42	1.49	0.76
6.1 m (20')	19.33	16.35	10.41	5.94	3.53	1.67
250W HPS						
18.3 m (60')	1.96	1.64	1.09	0.55	0.22	0.11
15.2 m (50')	2.84	2.40	1.74	0.82	0.31	0.16
12.2 m (40')	4.58	3.76	2.62	1.36	0.49	0.26
9.1 m (30')	7.85	6.54	4.69	2.08	0.87	0.46
6.1 m (20')	16.90	15.30	10.40	4.36	2.07	1.09
250W PSMH						
18.3 m (60')	1.90	1.63	0.82	0.48	0.27	0.14
15.2 m (50')	2.72	1.90	1.22	0.63	0.39	0.20
12.2 m (40')	4.48	2.96	1.90	1.09	0.61	0.30
9.1 m (30')	8.00	6.40	3.26	1.76	1.09	0.55
6.1 m (20')	14.40	11.97	7.61	4.35	2.58	1.22

For 175W PSMH Lamps 0.85; for 250W PSMH use 1.22.

♦ i.e., ratio of distance to height. Example: @ 6.1 meter (20 foot) mounting height, 1 means 6.1 meter (20 foot); 2 means 12.2 meter (40 foot), etc.

♦ Photometric charts available on request.

Areamaster™ 1000 Floodlights

Integrally Ballasted. 1000 W and 1500 W HID

For ordinary locations. NOT available for use in CEC governed locations.

NEC:
Listed for Ordinary (Unclassified) Locations

Applications

- Powerful, efficient weatherproof floodlights for large areas such as:
 - Shopping malls
 - Industrial complexes
 - Ship loading areas
 - Mining sites
 - Parking lots
 - Sports areas
- Suitable for wet locations.

Features

- Highly efficient, integrally ballasted floodlight. Has compact, lightweight, yet rugged diecast aluminum construction. Combines architecturally beautiful design with rugged dependability, simple installation and maintenance.
- Easy to install and service.
- A wide range of ballasts and voltages are available for both domestic and export applications.
- Integral ballast.
- One-piece housing.
- One-piece lens cover. Secured by four 1/4" Dia. captive stainless steel slotted hex-head bolts.
- Thermal shock and impact resistant glass lens.
- Heavy duty, high temperature silicone rubber gasket, firmly seated.
- Heavy duty mogul-base porcelain socket with heavy gauge brass, nickel-plated, double lamp-grip screw shell and spring-loaded center contact.
- Compound parabolic, double segment, finished aluminum reflector for optimum efficiency.
- Mounting choice:
 - (1) Yoke mount, zinc plated steel yoke with architectural bronze polyester finish.
 - (2) Pole mount, built-in slip-fitter, for internal wiring, adjustable laterally and vertically, slip fits 2" or 2-1/2" pipe, architectural bronze polyester finish.
- 3/4" NPT tapped hub for power entry.



Yoke



Slip-Fit

Projected Area: 0.31 Sq. M (3.36 Sq. Ft.)

Standard Materials

- Ballast housing and lens door: copperfree (4/10 of 1% max.) aluminum
- Gasket: silicone rubber
- Socket: heavy duty porcelain with heavy gauge brass shell
- Reflector: finished aluminum
- Yoke mount: zinc plated steel
- Bolts: stainless steel

Standard Finishes

- Ballast housing, lens cover, yoke and pole mount: architectural bronze polyester
- Socket: nickel-plated

NEC Certifications and Compliances

- UL Standard: UL 1598
- UL Listed: E85142

HID/FLOODLIGHT: NEC/CEC ORDINARY LOCATION

Order using catalog numbering guide below or select catalog number from tables on following pages.

Catalog Numbering Guide For Areamaster 1000 Floodlights

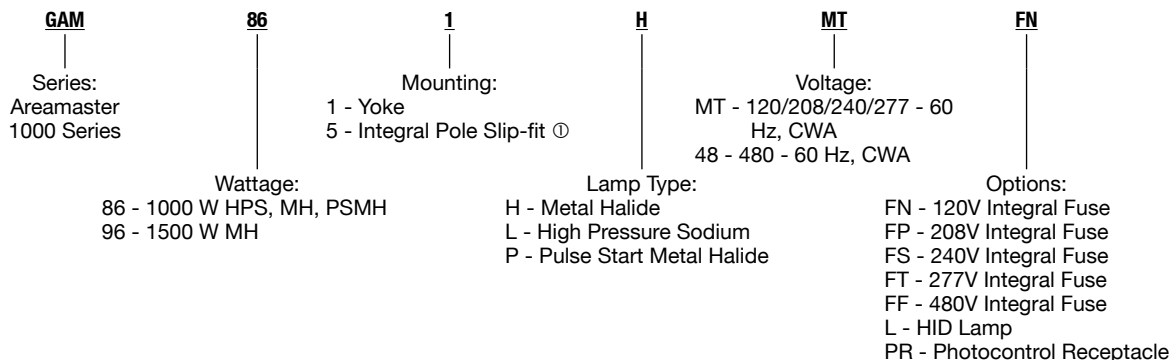

① Slip-fits 2" or 2-1/2" pipe-size tenons.

Areamaster™ 1000 Floodlights

Integrally Ballasted. 1000 W and 1500 W HID

For ordinary locations. NOT available for use in CEC governed locations.

NEC:

Listed for Ordinary (Unclassified) Locations

Lamp Watts	Line Voltage	Weight kg (lb)	Volume dm ³ (in ³)	Yoke Mount Catalog Number	Slip-Fit Mount Catalog Number ①
High Pressure Sodium					
1000	120/208/240/277	29.48 (65.0)	75.7 (4620)	G-AM861L-MT	G-AM865L-MT
1000	480			G-AM861L-48	G-AM865L-48
Metal Halide					
1000	120/208/240/277	29.48 (65.0)	75.7 (4620)	G-AM861H-MT	G-AM865H-MT
1000	480			G-AM861H-48	G-AM865H-48
1500	120/208/240/277	29.48 (65.0)	75.7 (4620)	G-AM961H-MT	G-AM965H-MT
1500	480			G-AM961H-48	G-AM965H-48
Pulse Start Metal Halide					
1000	120/208/240/277	29.48 (65.0)	75.7 (4620)	G-AM861P-MT	G-AM865P-MT
1000	480			G-AM861P-48	G-AM865P-48

Dimensions in Millimeters (Inches)

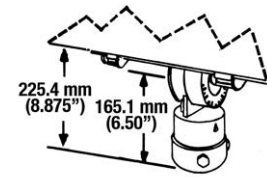
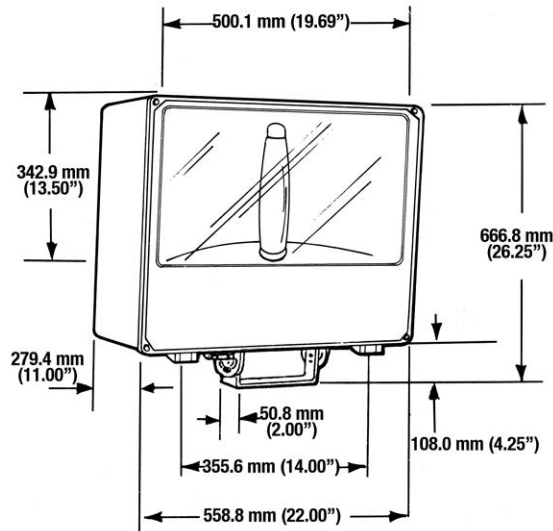

Slip-Fit Mount

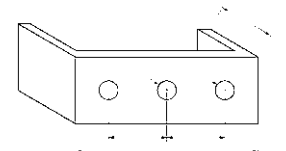

Yoke Mount







① Slip-fits 2" or 2-1/2" pipe-size tenons.

Areamaster™ 1000 Floodlights

Integrally Ballasted. 1000 W and 1500 W HID

For ordinary locations. NOT available for use in CEC governed locations.

NEC:
Listed for Ordinary (Unclassified) Locations

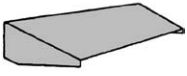
	Description	Catalog Numbers
Crossarm Mounting Bracket 	Has 180° horizontal adjustment — degree marked. Facilitates mounting floodlight to crossarm or other flat surface, or to G-AM-8-WB. Includes floodlight yoke bolts. Malleable iron, zinc plated, chromate sealed, architectural bronze polyester finish.	G-AM-8-CA
Pipe or Wall Mount Bracket 	Used with G-AM-8-CA. Clamps to 1" to 2-1/2" pipe, vertical or horizontal, or mounts on flat surfaces. Includes U-bolt and crossarm bracket bolts. Malleable iron, zinc plated, chromate sealed, with architectural bronze polyester finish.	G-AM-8-WB
Poletop Slip-Fitter 	Slip-fits 1-1/2" or 2" pipe size poletop tenons. Includes floodlight yoke bolts, 3 locking bolts, and cord grip. Body is malleable iron-zinc plated, chromate sealed, with cast aluminum cap. Assembly has architectural bronze polyester finish.	G-SF20
	Slip-fits 2" or 2-1/2" poletop tenons. Includes floodlight yoke bolts, 3 locking bolts, and cord grip. Malleable iron, zinc plated, chromate sealed, with architectural bronze polyester finish.	G-AM-8-SF
Locking-Type Photocontrol Receptacle 	For NEMA type photocontrol, with installation hardware and instructions.	G-1PCR
Vandal Shield 	UV stabilized polycarbonate, with installation hardware and instructions.	G-AM-8-NVS
Top Visor 	Easy to install with hardware supplied. Aluminum, with architectural bronze polyester finish.	G-AM-6-NV

HID/FLOODLIGHT: NEC/CEC ORDINARY LOCATION

Appleton®

Areamaster™ 1000 Floodlights

Integrally Ballasted. 1000 W and 1500 W HID

For ordinary locations. NOT available for use in CEC governed locations.

NEC:

Listed for Ordinary (Unclassified) Locations

Photometric Data

Typical Footcandle Values ①

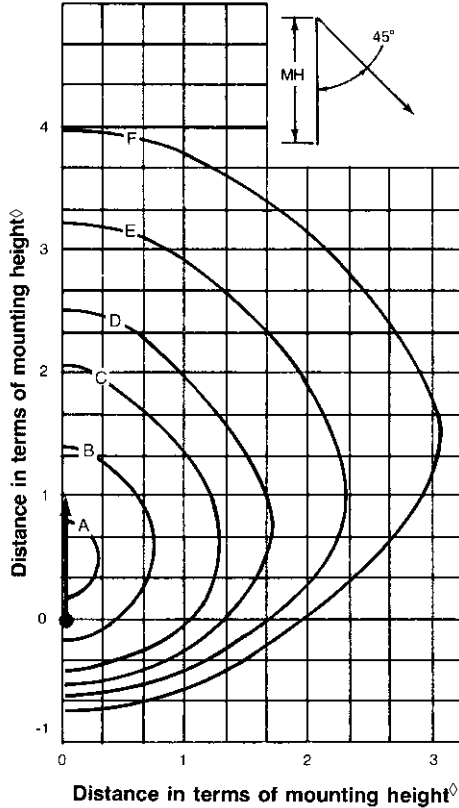

Mtg. Ht. M (Ft)	Footcandle Values for Iso Footcandle Lines					
	A	B	C	D	E	F
1000W HPS Clear, 140,000 Lumens, Cat. No. G-AM861L-MT						
18.3 (60)	8.0	3.0	1.0	0.5	0.20	0.10
15.2 (50)	11.5	4.6	1.5	0.72	0.27	0.15
12.2 (40)	17.3	6.8	2.4	1.0	0.45	0.21
9.1 (30)	31.5	12	4.1	1.9	0.80	0.30
1000W MH Clear, 110,000 Lumens, Cat. No. G-AM861H-MT						
18.3 (60)	6.0	3	1.0	0.5	0.20	0.10
15.2 (50)	8.2	4.2	1.4	0.8	0.28	0.15
12.2 (40)	12.6	7.9	2.3	1.2	0.42	0.19
9.1 (30)	23.0	11.6	4.0	2.1	0.70	0.25

Photometric Data ①

	HPS	MH	PSMH
Horiz. Spread	134°	133°	
Vert. Spread	131°	124°	
Beam Lumens	77,440	62,112	
Beam Effic.	55.3%	56.5%	
Max. CP	40,251	45,909	
Avg. Max. CP	38,396	38,490	
Total Lumens	80,846	66,008	
Total Effic.	57.7%	60.0%	

Electrical Specifications

Lamp Type	Line Voltage	Type of Ballast	Starting Amps	Operating Amps	Total Watts
1000 Watt High Pressure Sodium					
HPS	120	CWA	6.35	9.50	1100
HPS	208	CWA	3.80	5.50	1100
HPS	240	CWA	3.20	4.25	1100
HPS	277	CWA	2.75	4.20	1100
HPS	347	CWA	2.20	3.30	1100
HPS	480	CWA	1.80	2.45	1100
1000 Watt Metal Halide					
MH	120	CWA	8.00	9.20	1080
MH	208	CWA	4.60	5.30	1080
MH	240	CWA	4.00	4.60	1080
MH	277	CWA	3.50	4.00	1080
MH	347	CWA	2.50	3.20	1080
MH	480	CWA	2.00	2.30	1080
1500 Watt Metal Halide					
MH	120	C.W.A.	13.50	14.00	1610
MH	208	C.W.A.	7.70	8.00	1610
MH	240	C.W.A.	6.70	7.00	1610
MH	277	C.W.A.	5.90	6.00	1610
MH	480	C.W.A.	3.30	3.50	1610
1000 Watt Pulse Start					
PSMH	120	Super CWA	7.00	9.00	1080
PSMH	208	Super CWA	4.00	5.30	1080
PSMH	240	Super CWA	3.50	4.50	1080
PSMH	277	Super CWA	3.00	3.90	1080
PSMH	480	Super CWA	N/A	N/A	1080

① Photometric charts available on request.

◇ i.e., ratio of distance to height. Example: @ 6.1 meters (20 feet) mounting height, 1 means 6.1 meters (20 feet); 2 means 12.2 meters (40 feet), etc.

Beam-Master™ Floodlights

General Purpose and Heavy Duty.

Ballast for 1000 W, 1500 W MH; 400 W, 1000 W HPS.

NEC/CEC:

Listed for Ordinary (Unclassified) Locations

Applications

- To illuminate large areas such as:
 - Building facades
 - Ship loading docks
 - Truck terminals
 - Security lighting
 - Airports
 - Athletic stadiums
 - Sports fields

Features

- General purpose and heavy duty units available for 1000 W or 1500 W metal halide lamps or 400 W and 1000 W high pressure sodium lamps. Choice of five different NEMA beam spreads (1000 W HPS, two beam spreads).
- Compact design combines reflector assembly and ballast housing as a single unit — easier to wire and install.
- Balanced weight distribution allows swing-over design for easy relamping and servicing.
- Sturdy and rugged — withstands high vibration and rugged usage.
- Breather openings allow unit to breathe, yet keep dirt and moisture out.
- Floodlights have aiming device, plus 180° vertical positioning scale. Fully adjustable horizontally with crossarm bracket or poletop mount.
- Swing-over design with a “memory” locking device for accurate return to pre-aimed position after servicing.
- Mogul base porcelain socket has heavy gauge brass, nickel plated, double lamp-grip screw shell and spring-loaded center contact.
- Heavy duty models have heavy shroud for protection against severe weather, such as high winds and hail.
- Cord enters through a weatherproof cord grip.
- Yoke is rugged 6061-T6 aluminum alloy. Crossarm bracket and poletop slip-fitter are malleable iron.
- Ballasts are Class H insulated, UL Listed, C.W.A. type, available multi-tapped 120, 208, 240, or 277 Volts, or single-tap for 480 Volts.

Standard Materials

- Reflectors: aluminum
- Lens: shock and impact resistant glass
- Gasket: one-piece silicone rubber gasket
- Frame and clamps: stainless steel
- Socket/ballast: cast aluminum
- Housing: malleable Iron

Standard Finishes

- Reflectors: natural finish
- Ballast: white powder coated polyester finish
- Housing: zinc plated, chromate sealed, architectural bronze polyester finish

NEC/CEC Certifications and Compliances

- UL Listed: E85142
- UL Standard: 1598
- CSA Certified: LR9349



Dimensions in Millimeters (Inches)

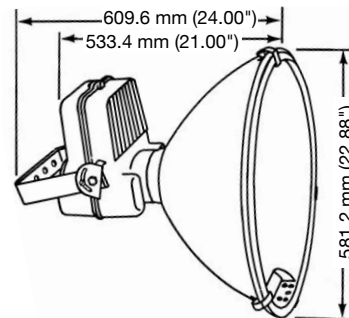

Mounting Options



Poletop Slip-Fitter Mounting



Crossarm Mounting

Beam-Master™ Floodlights

General Purpose and Heavy Duty.

Ballast for 1000 W, 1500 W MH; 400 W, 1000 W HPS.

NEC/CEC:

Listed for Ordinary (Unclassified) Locations

NEMA Type	Beam Spread Horiz x Vert.	Beam Lumens	Beam Efficacy	Candlepower		Line Voltage	Catalog Number	
				Avg. Max. CP	Max CP		General Purpose	Heavy Duty
With Ballast for 1000 W Metal Halide Lamp ②								
II	20.2° x 21.1°	37,577	34.2%	1,332,312	1,547,349	120/208/240/277 480	G-SM821H-MTN ①	G-SM821HH-MTN ①
							G-SM821H-48N	G-SM821HH-48N
III	45.1° x 45.1°	55,104	50.1%	481,977	638,600	120/208/240/277 480	G-SM831H-MTN ①	G-SM831HH-MTN ①
							G-SM831H-48N	G-SM831HH-48N
IV	58.6° x 59.3°	61,562	56.0%	213,277	266,126	120/208/240/277 480	G-SM841H-MTN ①	G-SM841HH-MTN ①
							G-SM841H-48N	G-SM841HH-48N
V	73.6° x 74.0°	66,843	60.8%	128,822	160,661	120/208/240/277 480	G-SM851H-MTN ①	G-SM851HH-MTN ①
							G-SM851H-48N	G-SM851HH-48N
VI	111.5° x 111.2°	74,020	67.3%	76,050	82,363	120/208/240/277 480	G-SM861H-MTN ①	G-SM861HH-MTN ①
							G-SM861H-48N	G-SM861HH-48N
With Ballast for 1500 W Metal Halide Lamp ②								
II	20.2° x 21.1°	52,950	34.2%	1,877,349	2,180,356	120/208/240/277 480	G-SM921H-MTN ①	G-SM921HH-MTN ①
							G-SM921H-48N	G-SM921HH-48N
III	45.1° x 45.1°	77,646	50.1%	679,149	899,846	120/208/240/277 480	G-SM931H-MTN ①	G-SM931HH-MTN ①
							G-SM931H-48N	G-SM931HH-48N
IV	58.6° x 59.3°	86,746	56.0%	300,526	374,996	120/208/240/277 480	G-SM941H-MTN ①	G-SM941HH-MTN ①
							G-SM941H-48N	G-SM941HH-48N
V	73.6° x 74.0°	94,188	60.8%	181,522	226,386	120/208/240/277 480	G-SM951H-MTN ①	G-SM951HH-MTN ①
							G-SM951H-48N	G-SM951HH-48N
VI	111.5° x 111.2°	104,301	67.3%	107,161	116,057	120/208/240/277 480	G-SM961H-MTN ①	G-SM961HH-MTN ①
							G-SM961H-48N	G-SM961HH-48N
With Ballast for 1000 W High Pressure Sodium Lamp								
V	69.1° x 65.2°	63,710	45.5%	175,347	302,942	120/208/240/277 480	G-SM851L-MTN ①	G-SM851LH-MTN ①
							G-SM851L-48N	G-SM851LH-48N
VI	110.3° x 104.6°	81,722	58.4%	81,998	107,556	120/208/240/277 480	G-SM861L-MTN ①	G-SM861LH-MTN ①
							G-SM861L-48N	G-SM861LH-48N
With Ballast for 400 W High Pressure Sodium Lamp								
II	—	—	—	—	—	120/208/240/277 480	G-SM721L-MTN ①	G-SM721LH-MTN ①
							G-SM721L-48N	G-SM721LH-48N
III	—	—	—	—	—	120/208/240/277 480	G-SM731L-MTN ①	G-SM731LH-MTN ①
							G-SM731L-48N	G-SM731LH-48N
IV	—	—	—	—	—	120/208/240/277 480	G-SM741L-MTN ①	G-SM741LH-MTN ①
							G-SM741L-48N	G-SM741LH-48N
V	—	—	—	—	—	120/208/240/277 480	G-SM751L-MTN ①	G-SM751LH-MTN ①
							G-SM751L-48N	G-SM751LH-48N
VI	—	—	—	—	—	120/208/240/277 480	G-SM761L-MTN ①	G-SM761LH-MTN ①
							G-SM761L-48N	G-SM761LH-48N

① For tri-tap 120/277/347 V, change suffix -MTN to -TTN.

② Mercury vapor and metal halide luminaires are not available for purchase within the United States. Please check with your countries governing legislation regarding allowable lamp types before ordering.

Beam-Master™ Floodlights

General Purpose and Heavy Duty.

Ballast for 1000 W, 1500 W MH; 400 W, 1000 W HPS.

NEC/CEC:

Listed for Ordinary (Unclassified) Locations

Mounting Fittings and Accessories

Description	Catalog Number
-------------	----------------

Crossarm Mounting Bracket

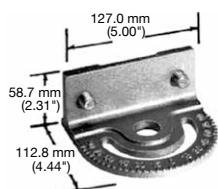

180° horizontal adjustment — degree-marked.
Facilitates mounting floodlight to crossarm or other flat surface, or to G-AM-8-WB.
Includes floodlight yoke bolts.

G-AM-8-CA

Poletop Slip-Fitter

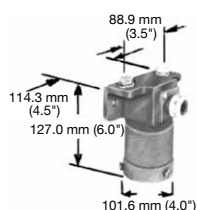

Slip-fits 50.8 or 63.5 mm (2" or 2-1/2") poletop tenons.
Includes floodlight yoke bolts, 3 locking bolts and cord grip.

G-AM-8-SF

Pipe or Wall Mount Bracket

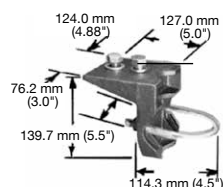

Used with G-AM-8-CA.
Clamps to 25.4 to 50.8 mm (1" to 2") pipe, vertical or horizontal, or mounts on flat surfaces.
Includes U-bolt and crossarm bracket bolts.

G-AM-8-WB

Fuse and Cartridge



Cartridges are furnished complete with two 254 mm (10") long high temperature wire leads and 600 Volt fuse.

10 Amp

G-F10

20 Amp

G-F20

Electrical Specifications

Line Volts	Start	Metal Halide — C.W.A. ① Ballast Amps			High Pressure Sodium — C.W.A. ① Ballast Amps			Start	Operating	Total Watts	Start	Operating	Total Watts
		1000 W	Start	Operating	1500 W	Start	Operating						
120	8.0	9.20	1080	13.50	14.0	1610	3.30	3.80	465	6.35	9.50	1100	
208	4.6	5.30	1080	7.70	8.00	1610	1.80	2.20	465	3.80	5.50	1100	
240	4.0	4.60	1080	6.70	7.00	1610	1.60	1.90	465	3.20	4.80	1100	
277	3.50	4.00	1080	5.90	6.00	1610	1.40	1.70	465	2.75	4.20	1100	
480	2.00	2.30	1080	2.25	3.50	1610	0.80	1.00	465	1.80	2.45	1100	

① C.W.A. — Constant Wattage Autotransformer.

Mercmaster™ III Low Profile Compact Fluorescent Luminaires

Enclosed and Gasketed. For Hazardous and Wet Locations

Compact Fluorescent listed for simultaneous exposure to combustible dusts and flammable gases or vapors.

NEC/CEC:

Class I, Division 2, Groups A, B, C, D
Class I, Zone 2, AEx nA nR IIC (Z2)
Class II, Division 1 and 2, Groups E, F, G
Class III

NEC/CEC:

Simultaneous Exposure (Class I, Division 2/
Class II, Division 1)
Fixtures Outside Type (Salt Water)
Type 4X
IP66

CEC:

Class I, Zone 2, Ex nR IIC (Z)

Applications

- Enclosed and gasketed fixtures suitable for use in marine and wet locations, and in a wide range of industrial, chemical processing and other areas where flammable gases and vapors or combustible dusts are present under conditions defined by the National Electrical Code as Class I, Division 2; Class II, Division 1 and 2; and Class III. The method of protection for the Zone 2 Mercmaster is AEx nA nR – Restricted Breathing/Nonsparking.
- For use in areas of low clearance, low ceiling heights or where fixture weights must be minimized.
- Suited for use in non-hazardous locations where severe weather conditions, excessive moisture, dirt, dust or corrosive atmospheres are present.
- Typical applications include oil refineries, pulp and paper mills, chemical plants, food-processing areas, inspection facilities, foundries, power plants, storage areas, waste and sewage treatment, parking garages, and other areas where dust, water, dirt and rough usage are a problem.

Features

- Energy-efficient, compact fluorescent light sources possess superior lamp efficiency.
- Fluorescent provides long lamp life, thereby reducing relamping costs.
- “Instant on” nature of this electronically ballasted fluorescent eliminates the possibility of an extended blackout due to a momentary power dip.
- High efficacies (up to 75 lumens per Watt) offer a desirable low-glare/instant-on alternative to low wattage HID sources.
- High output under widely varying conditions: Greater than 90% of rated lumens in ambient temperatures from -5 °C to +54 °C (+23 °F to +130 °F).
- Excellent color rendering (82 CRI) makes it the best choice for food processing and inspection facilities.
- A wide variety of lamp wattages: 26 W, 32 W, 42 W, 52 W, 64 W, 84 W.
- Electronic ballast permits low operating costs with power factor greater than 99%. Also allows flicker-free starting.
- Cold weather starting to a minimum temperature of -18 °C (0 °F).
- Fixtures are available for operation from an external 125 Vdc source.
- Compact, light-weight low profile design creates ease of installation and maintenance.
- Modular design, with multiple mounting hoods, optics and reflectors, permits a wide array of fixtures to meet installation and lighting needs.
- Body gaskets and optic gaskets are high temperature silicone O-Rings that provide superior sealing.
- Mounting hoods have a high hinge for added safety during installation and servicing.
- Choice of heat-resistant prismatic glass refractor (NEMA I, III or V), heat-resistant clear globes, color globes or polymeric refractors (NEMA II, III, IV or V). (Polymeric refractors are not listed for Zone 2.)



Pendant Mount Fixture
with Glass Globe

Ceiling Mount Fixture with
Prismatic Glass Refractor

Standard Materials

- Standard dome or 30° angle reflectors: highly reflective fiberglass reinforced white polyester to provide strength, corrosion resistance and excellent photometrics
- Fixture housing, mounting hoods, and guards: die-cast, copperfree (4/10 of 1% max.) aluminum with epoxy finish for corrosion resistance
- Exposed hardware: stainless steel. Latch assemblies have stainless steel bolt and captive nut; reflectors and guards attach with stainless steel screws threading into stainless steel inserts
- Globes and glass refractors: heat-resistant prismatic glass
- Polymeric refractor: spun aluminum refractor and a lens made of an engineered thermoplastic

Standard Finishes

- Epoxy powder coat finish electrostatically applied for complete, uniform surface protection

Options

- Fuse can be field installed. Kits include fuse block, wire connectors and screws for attachment to mounting hood.
 - Fixtures with fuses do not comply with UL 1598A for marine listing
 - Canadian Electrical Code does NOT allow fusing in hazardous locations
- Guards with gray epoxy painted to match fixtures, supplied with stainless steel screws. Add suffix **-G**.
- Reflectors are available as standard dome and 30° angle polyester. Order separately.

NEC/CEC Certifications and Compliances

- UL Standard: UL 1598, UL 1598A, UL 844, UL 60079-0, UL 60079-15
- UL Listed: E10444
- CSA Standard: C22.2 No. 250, C22.2 No. 137, CAN E60079-0, CAN E60079-15
- CSA Certified: 025428

Mercmaster™ III Low Profile Compact Fluorescent Luminaires

Enclosed and Gasketed. For Hazardous and Wet Locations

Compact Fluorescent listed for simultaneous exposure to combustible dusts and flammable gases or vapors.

NEC/CEC:

Class I, Division 2, Groups A, B, C, D
Class I, Zone 2, AEx nA nR IIC (Z2)
Class II, Division 1 and 2, Groups E, F, G
Class III

NEC/CEC:

Simultaneous Exposure (Class I, Division 2/
Class II, Division 1)
Fixtures Outside Type (Salt Water)
Type 4X
IP66

CEC:

Class I, Zone 2, Ex nR IIC (Z)

Appleton

FLUORESCENT/AREA: NEC/CEC ENCLOSED AND GASKETED

Illustrated Features



Globe Chamber

Completely sealed from the ballast housing and outside vapors/air (nA nR).

Epoxy Finish

Ballast housing, hoods and guards are copperfree aluminum with epoxy powder coat finish.

Photocell

Installs through knock-out in mounting hoods except cone and ceiling mount. Provides continuous on-off dusk-to-dawn control. Not for use in hazardous (classified) areas. Hazardous location rated photocells also available. See Accessories page.



Stainless Steel Latch Assembly

Captive, stainless steel latch assembly bolt and nut closes securely, resists attack of corrosive atmospheres. Swing-away design simplifies servicing.



Vented Reflectors

Reflectors are thick, tough fiberglass-reinforced white polyester, vented for cooler operation. Quickly attach with furnished stainless steel screws.

Terminal Blocks (Zone 2)

A seven-point terminal block is provided to facilitate wiring. Terminal block accommodates wire size ranging from #8 to #24 AWG.

Stainless Steel Inserts

Ballast bodies have stainless steel threaded inserts to receive stainless steel screws for reflectors and guard. Prevents "freezing", allowing guards and reflectors to be easily removed and replaced at any time, without damage to the housing.

Prismatic Glass Globes and Refractors

Heat-resistant globes and glass refractors and polymeric refractors thread directly into ballast housing and seal against a high temperature silicone rubber gasket. (Polymeric refractors are not listed for Zone 2 areas.)



Ballast Assembly

Utilizing non-sparking components avoiding the ignition of gases or vapors that may be present (nA).

Hood/Ballast Gasket

Silicone rubber gasket seals out moisture, dirt and dust. Stays flexible, withstands high temperatures. Closure design assures uniform gasket compression.

Electrical Protection

Ground wire provided to bond mounting hood to ballast housing.



Cooler Operating Cone Hood

Larger sloped surface sheds dusts, dirt and combustible fibers providing better heat dissipation.

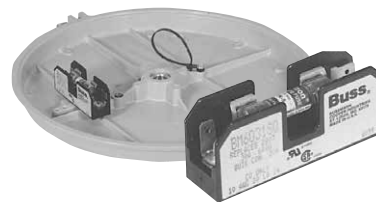

Fuses

Two screws secure fuse kit to mounting boss in any Mercmaster mounting hood. Fuse included.



"Safety" High Hinge

Extra-high hinge provides additional protection against accidental ballast housing disengagement during installation or maintenance.

Mercmaster™ III Low Profile Compact Fluorescent Luminaires

Enclosed and Gasketed. For Hazardous and Wet Locations

Compact Fluorescent listed for simultaneous exposure to combustible dusts and flammable gases or vapors.

NEC/CEC:

Class I, Division 2, Groups A, B, C, D
 Class I, Zone 2, AEx nA nR IIC (Z2)
 Class II, Division 1 and 2, Groups E, F, G
 Class III

NEC/CEC:

Simultaneous Exposure (Class I, Division 2/
 Class II, Division 1)
 Fixtures Outside Type (Salt Water)
 Type 4X
 IP66

CEC:

Class I, Zone 2, Ex nR IIC (Z)

Mercmaster III Low Profile Compact Fluorescent Family Tree

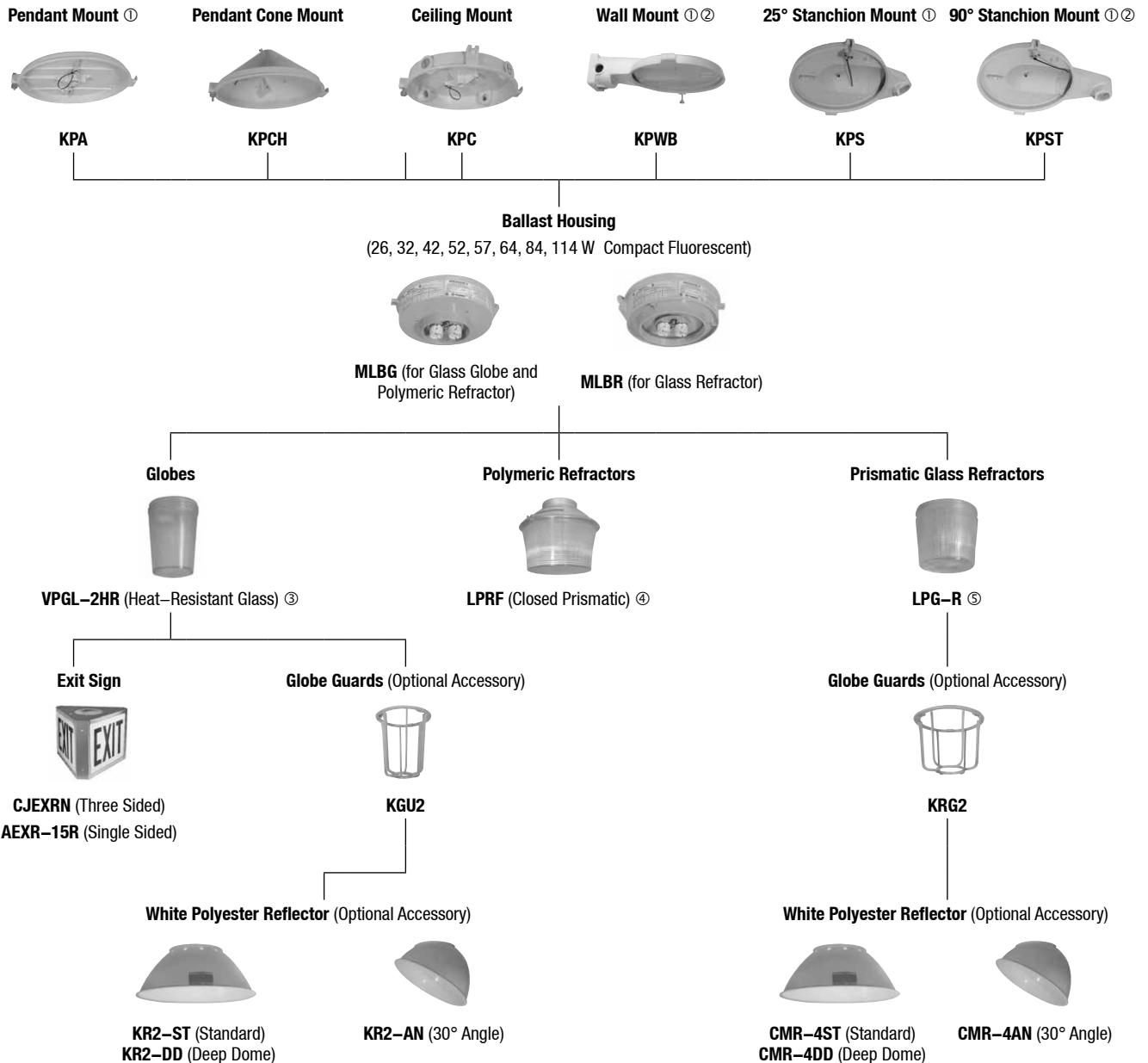

① Mounting hood with a 120 V or 208-277 V factory installed photocell is available.

② Standard and deep dome reflectors may interfere with bottom conduit entry if used with KPST and KPWB mounting hoods..

③ Available in clear, amber, blue, green and red.

④ Available in NEMA Type II, III, IV and V. Polymeric Refractor suitable for Class II, Groups F and G, NEMA 4X and Marine Type Electric Fixtures Outside Type (Salt Water) only (100 W PSMH Max.).

⑤ Available in NEMA Type I, III and V.

Mercmaster™ III Low Profile Compact Fluorescent Luminaires

Enclosed and Gasketed. For Hazardous and Wet Locations

NEC/CEC:

Class I, Division 2, Groups A, B, C, D
Class I, Zone 2, AEx nA nR IIC (Z2)
Class II, Division 1 and 2, Groups E, F, G
Class III

NEC/CEC:

Simultaneous Exposure (Class I, Division 2/
Class II, Division 1)
Fixtures Outside Type (Salt Water)
Type 4X
IP66

CEC:

Class I, Zone 2, Ex nR IIC (Z)

Order using catalog numbering guide below or select catalog number from tables on following pages.

Catalog Numbering Guide For Zone 2 Mercmaster III Compact Fluorescent Luminaires

<p>ML</p> <p>Series: ML - Mercmaster III Low Profile</p>	<p>A</p> <p>Mounting Hood: A - Pendant (Rigid or Flexible) C - Ceiling D - Pendant Cone R - 90° Stanchion S - 25° Stanchion W - Wall</p>	<p>F</p> <p>Lamp Type: F - Fluorescent</p>	<p>84</p> <p>Wattage: 26 - One 26 Watt PL-T 32 - One 32 Watt PL-T 42 - One 42 Watt PL-T 52 - Two 26 Watt PL-T 57 - One 57 Watt PL-T ③ 64 - Two 32 Watt PL-T 84 - Two 42 Watt PL-T 114 - Two 57 Watt PL-T ④</p>	<p>2</p> <p>Hub Size: 2 - 3/4" NPT 3 - 1" NPT 4 - 1-1/4" NPT Stanchion 5 - 1-1/2" NPT Stanchion</p>	<p>G2</p> <p>Optical Assembly: ① G2 - VPGL2HR Globe (not for 57, 114 Watt) G4 - VPGL4HR Globe (57, 114 Watt only) ④ J1 - NEMA I Glass Refractor J3 - NEMA III Glass Refractor J5 - NEMA V Glass Refractor P2 - NEMA II Polymeric Refractor P3 - NEMA III Polymeric Refractor P4 - NEMA IV Polymeric Refractor P5 - NEMA V Polymeric Refractor</p>	<p>G</p> <p>Guard Options: G - Cast Guard (Glass Refractor and Globe only) N - No Guard</p>	<p>BU</p> <p>Voltage: BU - 120 to 277 V, 50/60 Hz and 125 Vdc A5 - 347 V, 60 Hz ④</p>	<p>L</p> <p>Lamp Options: L - Lamp(s) included Blank - Lamp(s) excluded</p>	<p>Z2</p> <p>Suffix: DP - Safety Cable SC - Safety Chain Z2 - Zone 2 Suffix (Required for AEx nA nR rating) C - Safety Cable ④ F - Fused Mtg. Hood ③④ (Non-Haz. Loc. only) P - Non-Haz. Photocell (Specify Voltage) ④ Q - Division 2 Haz. Photocell (Specify Voltage) ④ T - Terminal Blocks ④ V - Vibration Protection ④ X - Appledapter ② Mounting Hood Adapter ④ Z - Zone 2 suffix (required for Ex nR) ④</p>
---	---	---	---	--	--	--	--	--	--

① Polymeric refractors suitable for Class II, Groups F and G; NEMA 4X; and Marine Type Electric Fixture Outside Type (Salt Water) only.

Reflectors ordered separately (for use with globe fixtures only): Standard Dome: KR2-ST 30-degree Angle: KR2-AN

② Appledapter is available for use with the pendant, ceiling and angled stanchion mounting only.

③ Canadian Electrical Code (CEC) does NOT allow fusing in hazardous locations.

④ Certified to meet the Canadian Electrical Code (CEC) only.

Mercmaster™ III Low Profile Compact Fluorescent Luminaires

Class I, Division 2; Class II, Division 1; Simultaneous Exposure to Hazardous Conditions

Temperature identification numbers of Mercmaster III Low Profile Fluorescent Fixtures

NEC/CEC:

Class I, Division 2, Groups A, B, C, D
Class I, Zone 2, AEx nA nR IIC (Z2)
Class II, Division 1 and 2, Groups E, F, G
Class III

NEC/CEC:

Simultaneous Exposure (Class I, Division 2/
Class II, Division 1)
Fixtures Outside Type (Salt Water)
Type 4X
IP66

CEC:

Class I, Zone 2, Ex nR IIC (Z)

Thermal Performance

Lamp Watts	Ambient Temp °C (°F) ①	Class I, Division 2				Class II, Division 1 Groups E, F and G ②				Simultaneous Exposure (Class I, Div 2 and Class II, Division 1)			
		Globe	Reflector	Glass Refractor	Polymeric Refractor	Globe	Reflector	Glass Refractor	Polymeric Refractor	Globe	Reflector	Glass Refractor	Polymeric Refractor
26	40 °C (104 °F)	T3	T3	T3	—	T5	T5	T5	T6	T3	T3	T3	—
32	40 °C (104 °F)	T3	T3	T3	—	T5	T5	T5	T6	T3	T3	T3	—
42	40 °C (104 °F)	T3	T3	T3	—	T5	T5	T5	T6	T3	T3	T3	—
52	40 °C (104 °F)	T2D	T2D	T3	—	T4A	T4A	T4A	T6	T2C	T2C	T2C	—
	55 °C (151 °F)	T2C	T2C	T2C	—	T4	T4	T4	—	T2C	T2C	T2C	—
57 ③	40 °C (104 °F)	T2D	T2D	T3	—	T4A	T4A	T4A	T6	—	—	—	—
64	40 °C (104 °F)	T2D	T2D	T3	—	T4A	T4A	T4A	T6	T2C	T2C	T2C	—
	55 °C (151 °F)	T2C	T2C	T2C	—	T4	T4	T4	—	—	—	—	—
84	40 °C (104 °F)	T2C	T2C	T2D	—	T3C	T3C	T3C	T6	T2B	T2B	T2B	—
114 ③	40 °C (104 °F)	T2C	T2C	T2D	—	T3C	T3C	T3C	T6	—	—	—	—

“T” Numbers Represent the Maximum Lamp Temperature for Class I, Division 2 Locations and Maximum Surface Temperature Under Dust Blanket for Class II, Division 1 Locations.

“T” Number	T1	350	325	T2	T2A	T2B	T2C	T2D	T3	T3A	T3B	T3C	T4	T4A	T5	T6
Temp. Range (°C)	351-450	326-350	301-325	281-300	261-280	231-260	216-230	201-215	181-200	166-180	161-165	136-160	121-135	101-120	86-100	85
Temp. Range (°F)	664-842	619-662	574-617	538-572	502-536	448-500	421-446	394-419	358-392	331-356	322-329	277-320	250-275	214-248	187-212	185

Lamp Watts	Supply Wire Temp. °C (°F)	Ambient Temp. °C (°F)	Class I, Zone 2, AEx nA nR — Ex nR		
			Globe	Globe and Reflector	Refractor
26	75 °C (167 °F)	40 °C (104 °F)	T5	T5	T6
32	75 °C (167 °F)	40 °C (104 °F)	T5	T5	T6
42	75 °C (167 °F)	40 °C (104 °F)	T5	T5	T6
52	75 °C (167 °F)	40 °C (104 °F)	T5	T5	T6
	75 °C (167 °F)	55 °C (131 °F)	T4	T4	T4
57 ③	75 °C (167 °F)	40 °C (104 °F)	T6	T6	T6
64	75 °C (167 °F)	40 °C (104 °F)	T5	T5	T6
	75 °C (167 °F)	55 °C (131 °F)	T4	T4	T4
84	75 °C (167 °F)	40 °C (104 °F)	T5	T5	T6
114 ③	75 °C (167 °F)	40 °C (104 °F)	T6	T6	T6

“T” Numbers Represent the Maximum Surface Temperature for Luminaires with AEx nA nR Rating

“T” Number	T1	T2	T3	T4	T5	T6
Temperature Range (°C)	301-450	201-300	136-200	101-135	86-100	85
Temperature Range (°F)	574-842	394-572	277-392	214-275	187-212	185

① Use +75 °C (+167 °F) rated supply wire.

② Fixtures with Polymeric Refractor are listed for Groups F and G only.

③ Certified to meet the Canadian Electrical Code (CEC) only.

Mercmaster™ III Low Profile Compact Fluorescent Luminaires

Enclosed and Gasketed. For Hazardous and Wet Locations

High Power Factor Electronic Ballast (Min. P.F. 99%), PL-T Lamps.

NEC/CEC:
Class I, Division 2, Groups A, B, C, D
Class I, Zone 2, AEx nA nR IIC (Z2)
Class II, Division 1 and 2, Groups E, F, G
Class III

NEC/CEC:
Simultaneous Exposure (Class I, Division 2/
Class II, Division 1)
Fixtures Outside Type (Salt Water)
Type 4X
IP66

CEC:
Class I, Zone 2, Ex nR IIC (Z)

Appleton

FLUORESCENT/AREA: NEC/CEC ENCLOSED AND GASKETED

Lamp Watts	Hub Size (Inches)	With Globe ①④	Catalog Numbers ②③	
			With Type V 8" Glass Refractor ①④⑤	With Type V Polymeric Refractor ⑥
Pendant — One Hub (Rigid or Flexible Mounting)				
1 x 26 W	3/4	MLAF262G2N	MLAF262J5N	MLAF262P5N
	1	MLAF263G2N	MLAF263J5N	MLAF263P5N
1 x 32 W	3/4	MLAF322G2N	MLAF322J5N	MLAF322P5N
	1	MLAF323G2N	MLAF323J5N	MLAF323P5N
1 x 42 W	3/4	MLAF422G2N	MLAF422J5N	MLAF422P5N
	1	MLAF423G2N	MLAF423J5N	MLAF423P5N
2 x 26 W	3/4	MLAF522G2N	MLAF522J5N	MLAF522P5N
	1	MLAF523G2N	MLAF523J5N	MLAF523P5N
1 x 57 W	3/4	MLAF572G4N ⑦	MLAF572J5N ⑦	MLAF572P5N ⑦
	1	MLAF573G4N ⑦	MLAF573J5N ⑦	MLAF573P5N ⑦
2 x 32 W	3/4	MLAF642G2N	MLAF642J5N	MLAF642P5N
	1	MLAF643G2N	MLAF643J5N	MLAF643P5N
2 x 42 W	3/4	MLAF842G2N	MLAF842J5N	MLAF842P5N
	1	MLAF843G2N	MLAF843J5N	MLAF843P5N
2 x 57 W	3/4	MLAF1142G4N ⑦	MLAF1142J5N ⑦	MLAF1142P5N ⑦
	1	MLAF1143G4N ⑦	MLAF1143J5N ⑦	MLAF1143P5N ⑦
Pendant Cone — One Hub (Rigid or Flexible Mounting)				
1 x 26 W	3/4	MLDF262G2N	MLDF262J5N	MLDF262P5N
	1	MLDF263G2N	MLDF263J5N	MLDF263P5N
1 x 32 W	3/4	MLDF322G2N	MLDF322J5N	MLDF322P5N
	1	MLDF323G2N	MLDF323J5N	MLDF323P5N
1 x 42 W	3/4	MLDF422G2N	MLDF422J5N	MLDF422P5N
	1	MLDF423G2N	MLDF423J5N	MLDF423P5N
2 x 26 W	3/4	MLDF522G2N	MLDF522J5N	MLDF522P5N
	1	MLDF523G2N	MLDF523J5N	MLDF523P5N
1 x 57 W	3/4	MLDF572G4N ⑦	MLDF572J5N ⑦	MLDF572P5N ⑦
	1	MLDF573G4N ⑦	MLDF573J5N ⑦	MLDF573P5N ⑦
2 x 32 W	3/4	MLDF642G2N	MLDF642J5N	MLDF642P5N
	1	MLDF643G2N	MLDF643J5N	MLDF643P5N
2 x 42 W	3/4	MLDF842G2N	MLDF842J5N	MLDF842P5N
	1	MLDF843G2N	MLDF843J5N	MLDF843P5N
2 x 57 W	3/4	MLDF1142G4N ⑦	MLDF1142J5N ⑦	MLDF1142P5N ⑦
	1	MLDF1143G4N ⑦	MLDF1143J5N ⑦	MLDF1143P5N ⑦



Shown with Glass Globe



Shown with 8" Glass Refractor

① For fixtures with guard, substitute **G** for **N** before adding voltage suffix.

② Add voltage suffix **-BU** for 120 through 277 V, 50/60 Hz and 125 Vdc. Add voltage suffix **-A5** for 347 V, 60 Hz.

③ Add **L** after voltage suffix to include lamp.

④ Add **Z2** suffix for factory-sealed non-sparking/restricted breathing protection (Aex nA nR).

⑤ To order fixture with NEMA Type I or III glass refractor, change **J5** to **J1** or **J3** respectively.

⑥ To order fixture with NEMA Type II, III, or IV polymeric refractor, change **P5** to **P2**, **P3** or **P4** respectively. Polymeric refractor fixtures are UL Listed and CSA Certified for Class II, Division 1 and 2, Groups F and G; Class III; Marine Outdoor Salt Water (UL1598A); NEMA 4X and CSA Type 4X.

⑦ Certified to meet the Canadian Electrical Code (CEC) only.

Mercmaster™ III Low Profile Compact Fluorescent Luminaires

Enclosed and Gasketed. For Hazardous and Wet Locations

High Power Factor Electronic Ballast (Min. P.F. 99%), PL-T Lamps.

NEC/CEC:



Class I, Division 2, Groups A, B, C, D
Class I, Zone 2, AEx nA nR IIC (Z2)
Class II, Division 1 and 2, Groups E, F, G
Class III

NEC/CEC:

Simultaneous Exposure (Class I, Division 2/
Class II, Division 1)
Fixtures Outside Type (Salt Water)
Type 4X
IP66

CEC:

Class I, Zone 2, Ex nR IIC (Z)

	Lamp Watts	Hub Size (Inches)	With Globe ①④	Catalog Numbers ②③	
				With Type V 8" Glass Refractor ①④⑤	With Type V Polymeric Refractor ⑥
Ceiling — Five Hubs, Four Close-Up Plugs					
	1 x 26 W	3/4	MLCF262G2N	MLCF262J5N	MLCF262P5N
		1	MLCF263G2N	MLCF263J5N	MLCF263P5N
	1 x 32 W	3/4	MLCF322G2N	MLCF322J5N	MLCF322P5N
		1	MLCF323G2N	MLCF323J5N	MLCF323P5N
	1 x 42 W	3/4	MLCF422G2N	MLCF422J5N	MLCF422P5N
		1	MLCF423G2N	MLCF423J5N	MLCF423P5N
	2 x 26 W	3/4	MLCF522G2N	MLCF522J5N	MLCF522P5N
		1	MLCF523G2N	MLCF523J5N	MLCF523P5N
	1 x 57 W	3/4	MLCF572G4N ⑦	MLCF572J5N ⑦	MLCF572P5N ⑦
		1	MLCF573G4N ⑦	MLCF573J5N ⑦	MLCF573P5N ⑦
	2 x 32 W	3/4	MLCF642G2N	MLCF642J5N	MLCF642P5N
		1	MLCF643G2N	MLCF643J5N	MLCF643P5N
	2 x 42 W	3/4	MLCF842G2N	MLCF842J5N	MLCF842P5N
		1	MLCF843G2N	MLCF843J5N	MLCF843P5N
2 x 57 W	3/4	MLCF1142G4N ⑦	MLCF1142J5N ⑦	MLCF1142P5N ⑦	
	1	MLCF1143G4N ⑦	MLCF1143J5N ⑦	MLCF1143P5N ⑦	
Wall Bracket — Five Hubs, Four Close-Up Plugs					
	1 x 26 W	3/4	MLWF262G2N	MLWF262J5N	MLWF262P5N
		1	MLWF263G2N	MLWF263J5N	MLWF263P5N
	1 x 32 W	3/4	MLWF322G2N	MLWF322J5N	MLWF322P5N
		1	MLWF323G2N	MLWF323J5N	MLWF323P5N
	1 x 42 W	3/4	MLWF422G2N	MLWF422J5N	MLWF422P5N
		1	MLWF423G2N	MLWF423J5N	MLWF423P5N
	2 x 26 W	3/4	MLWF522G2N	MLWF522J5N	MLWF522P5N
		1	MLWF523G2N	MLWF523J5N	MLWF523P5N
	1 x 57 W	3/4	MLWF572G4N ⑦	MLWF572J5N ⑦	MLWF572P5N ⑦
		1	MLWF573G4N ⑦	MLWF573J5N ⑦	MLWF573P5N ⑦
	2 x 32 W	3/4	MLWF642G2N	MLWF642J5N	MLWF642P5N
		1	MLWF643G2N	MLWF643J5N	MLWF643P5N
	2 x 42 W	3/4	MLWF842G2N	MLWF842J5N	MLWF842P5N
		1	MLWF843G2N	MLWF843J5N	MLWF843P5N
2 x 57 W	3/4	MLWF1142G4N ⑦	MLWF1142J5N ⑦	MLWF1142P5N ⑦	
	1	MLWF1143G4N ⑦	MLWF1143J5N ⑦	MLWF1143P5N ⑦	

① For fixtures with guard, substitute **G** for **N** before adding voltage suffix.

② Add voltage suffix **-BU** for 120 through 277 V, 50/60 Hz and 125 Vdc. Add voltage suffix **-A5** for 347 V, 60 Hz.

③ Add **L** after voltage suffix to include lamp.

④ Add **Z2** suffix for factory-sealed non-sparking/restricted breathing protection (Aex nA nR).

⑤ To order fixture with NEMA Type I or III glass refractor, change **J5** to **J1** or **J3** respectively.

⑥ To order fixture with NEMA Type II, III, or IV polymeric refractor, change **P5** to **P2**, **P3** or **P4** respectively. Polymeric refractor fixtures are UL Listed and CSA Certified for Class II, Division 1 and 2, Groups F and G; Class III; Marine Outdoor Salt Water (UL1598A); NEMA 4X and CSA Type 4X.

⑦ Certified to meet the Canadian Electrical Code (CEC) only.

Mercmaster™ III Low Profile Compact Fluorescent Luminaires

Enclosed and Gasketed. For Hazardous and Wet Locations

High Power Factor Electronic Ballast (Min. P.F. 99%), PL-T Lamps.

NEC/CEC:
Class I, Division 2, Groups A, B, C, D
Class I, Zone 2, AEx nA nR IIC (Z2)
Class II, Division 1 and 2, Groups E, F, G
Class III

NEC/CEC:
Simultaneous Exposure (Class I, Division 2/
Class II, Division 1)
Fixtures Outside Type (Salt Water)
Type 4X
IP66

CEC:
Class I, Zone 2, Ex nR IIC (Z)

Appleton

FLUORESCENT/AREA: NEC/CEC ENCLOSED AND GASKETED

Lamp Watts	Hub Size (Inches)	With Globe ①④	Catalog Numbers ②③	
			With Type V 8" Glass Refractor ①④⑤	With Type V Polymeric Refractor ⑥
25° Stanchion				
1 x 26 W	3/4	MLSF264G2N	MLSF264J5N	MLSF264P5N
	1	MLSF265G2N	MLSF265J5N	MLSF265P5N
1 x 32 W	3/4	MLSF324G2N	MLSF324J5N	MLSF324P5N
	1	MLSF325G2N	MLSF325J5N	MLSF325P5N
1 x 42 W	3/4	MLSF424G2N	MLSF424J5N	MLSF424P5N
	1	MLSF425G2N	MLSF425J5N	MLSF425P5N
2 x 26 W	3/4	MLSF524G2N	MLSF524J5N	MLSF524P5N
	1	MLSF525G2N	MLSF525J5N	MLSF525P5N
1 x 57 W	3/4	MLSF574G4N ⑦	MLSF574J4N ⑦	MLSF574P4N ⑦
	1	MLSF575G4N ⑦	MLSF575J4N ⑦	MLSF575P4N ⑦
2 x 32 W	3/4	MLSF644G2N	MLSF644J5N	MLSF644P5N
	1	MLSF645G2N	MLSF645J5N	MLSF645P5N
2 x 42 W	3/4	MLSF844G2N	MLSF844J5N	MLSF844P5N
	1	MLSF845G2N	MLSF845J5N	MLSF845P5N
2 x 57 W	3/4	MLSF1144G4N ⑦	MLSF1144J4N ⑦	MLSF1144P4N ⑦
	1	MLSF1145G4N ⑦	MLSF1145J4N ⑦	MLSF1145P4N ⑦
90° Stanchion				
1 x 26 W	3/4	MLRF264G2N	MLRF264J5N	MLRF264P5N
	1	MLRF265G2N	MLRF265J5N	MLRF265P5N
1 x 32 W	3/4	MLRF324G2N	MLRF324J5N	MLRF324P5N
	1	MLRF325G2N	MLRF325J5N	MLRF325P5N
1 x 42 W	3/4	MLRF424G2N	MLRF424J5N	MLRF424P5N
	1	MLRF425G2N	MLRF425J5N	MLRF425P5N
2 x 26 W	3/4	MLRF524G2N	MLRF524J5N	MLRF524P5N
	1	MLRF525G2N	MLRF525J5N	MLRF525P5N
1 x 57 W	3/4	MLRF574G4N ⑦	MLRF574J4N ⑦	MLRF574P4N ⑦
	1	MLRF575G4N ⑦	MLRF575J4N ⑦	MLRF575P4N ⑦
2 x 32 W	3/4	MLRF644G2N	MLRF644J5N	MLRF644P5N
	1	MLRF645G2N	MLRF645J5N	MLRF645P5N
2 x 42 W	3/4	MLRF844G2N	MLRF844J5N	MLRF844P5N
	1	MLRF845G2N	MLRF845J5N	MLRF845P5N
2 x 57 W	3/4	MLRF1144G4N ⑦	MLRF1144J4N ⑦	MLRF1144P4N ⑦
	1	MLRF1145G4N ⑦	MLRF1145J4N ⑦	MLRF1145P4N ⑦



Shown with Glass Globe



Shown with Polymeric Refractor

① For fixtures with guard, substitute **G** for **N** before adding voltage suffix.
 ② Add voltage suffix **-BU** for 120 through 277 V, 50/60 Hz and 125 Vdc. Add voltage suffix **-A5** for 347 V, 60 Hz.
 ③ Add **L** after voltage suffix to include lamp.
 ④ Add **Z2** suffix for factory-sealed non-sparking/restricted breathing protection (Aex nA nR).
 ⑤ To order fixture with NEMA Type I or III glass refractor, change **J5** to **J1** or **J3** respectively.
 ⑥ To order fixture with NEMA Type II, III, or IV polymeric refractor, change **P5** to **P2**, **P3** or **P4** respectively. Polymeric refractor fixtures are UL Listed and CSA Certified for Class II, Division 1 and 2, Groups F and G; Class III; Marine Outdoor Salt Water (UL1598A); NEMA 4X and CSA Type 4X.
 ⑦ Certified to meet the Canadian Electrical Code (CEC) only.

Mercmaster™ III Low Profile Compact Fluorescent Luminaires

Enclosed and Gasketed. For Hazardous and Wet Locations

Compact Fluorescent listed for simultaneous exposure to combustible dusts and flammable gases or vapors.

NEC/CEC:

Class I, Division 2, Groups A, B, C, D
 Class I, Zone 2, AEx nA nR IIC (Z2)
 Class II, Division 1 and 2, Groups E, F, G
 Class III



NEC/CEC:

Simultaneous Exposure (Class I, Division 2/
 Class II, Division 1)
 Fixtures Outside Type (Salt Water)
 Type 4X
 IP66

CEC:

Class I, Zone 2, Ex nR IIC (Z)

Ballast Bodies

	Lamp Wattage	Catalog Numbers	
		For Glass Globe or Polymeric Refractor ①②	For Glass Refractor ②
Compact PL-T Fluorescent – 120 V to 277 V, 50/60 Hz and 125 Vdc			
 <p>Ballast Body for Glass Globe or Polymeric Refractor ①</p>	1 x 26 W	MLBG26FBU	MLBR26FBU
	1 x 32 W	MLBG32FBU	MLBR32FBU
	1 x 42 W	MLBG42FBU	MLBR42FBU
	2 x 26 W	MLBG52FBU	MLBR52FBU
	1 x 57 W	—	MLBR57F ③
	2 x 32 W	MLBG64FBU	MLBR64FBU
	2 x 42 W	MLBG84FBU	MLBR84FBU
	2 x 57 W	—	MLBR114F ③
	 <p>Ballast Body for Glass Refractor</p>		

① Polymeric refractor not listed for Class I, Zone 2 areas.

② Add voltage suffix **-BU** for 120 through 277 V, 50/60 Hz and 125 Vdc. Add voltage suffix **-A5** for 347 V, 60 Hz.

③ Certified to meet the Canadian Electrical Code (CEC) only.

Mercmaster™ III Low Profile Compact Fluorescent Luminaires

Enclosed and Gasketed. For Hazardous and Wet Locations

Compact Fluorescent listed for simultaneous exposure to combustible dusts and flammable gases or vapors.

NEC/CEC:

Class I, Division 2, Groups A, B, C, D
Class I, Zone 2, AEx nA nR IIC (Z2)
Class II, Division 1 and 2, Groups E, F, G
Class III

NEC/CEC:

Simultaneous Exposure (Class I, Division 2/
Class II, Division 1)
Fixtures Outside Type (Salt Water)
Type 4X
IP66

CEC:

Class I, Zone 2, Ex nR IIC (Z)

Mounting Hoods

	Description	Hub Size (Inches)	Catalog Number
	One Hub, Rigid or Flexible Mounting	3/4 1	KPA-75 KPA-100
		Five Hubs, Four Close-Up Plugs	3/4 1
	Five Hubs, Four Close-Up Plugs	3/4 1	KPC-75 KPC-100
	Five Hubs, Four Close-Up Plugs	3/4 1	KPWB-75 KPWB-100
	One Hub	1-1/4 1-1/2	KPS-125 KPS-150
		One Hub	1-1/4 1-1/2

Mercmaster™ III Low Profile Compact Fluorescent Luminaires

Enclosed and Gasketed. For Hazardous and Wet Locations

Compact Fluorescent listed for simultaneous exposure to combustible dusts and flammable gases or vapors.

NEC/CEC:









Class I, Division 2, Groups A, B, C, D
 Class I, Zone 2, AEx nA nR IIC (Z2)
 Class II, Division 1 and 2, Groups E, F, G
 Class III

NEC/CEC:

Simultaneous Exposure (Class I, Division 2/
 Class II, Division 1)
 Fixtures Outside Type (Salt Water)
 Type 4X
 IP66

CEC:

Class I, Zone 2, Ex nR IIC (Z)

Item	Description	Catalog Number ③
White Polyester Reflectors		
 Standard Dome	For Globe Fixtures	
	Standard Dome 30° Angle	KR2-ST KR2-AN
 30° Angle Dome	For Glass Refractor Fixtures ①	
	Standard Dome 30° Angle	CMR-4ST ② CMR-4AN ②
Prismatic Glass Globes — Heat-Resistant ③		
	Clear	VPGL-2HR
	Amber ④	VPGL-2AM
	Blue ④	VPGL-2BL
	Green ④	VPGL-2GR
	Red ④	VPGL-2RE
	Clear — 57/114 Watt ⑤	VPGL-4HR
Closed Prismatic Glass Refractors — All Heat-Resistant ③		
	NEMA Type I	LPG-R1
	NEMA Type III	LPG-R3
	NEMA Type V	LPG-R5
Closed Prismatic Polymeric Refractors — Not Listed for Class I, Zone 2 Areas		
	NEMA Type II	LPRF-2CP
	NEMA Type III	LPRF-3CP
	NEMA Type IV	LPRF-4CP
	NEMA Type V	LPRF-5CP
Guards		
 Globe Guard	Globe Guard	KGU2
	 Glass Refractor Guard	Glass Refractor Guard
 Globe Guard for 57 W Only		Globe Guard — 57/114 W ⑤

① Fixtures with refractors are not UL Listed when used with reflectors.

② Standard dome reflectors may interfere with bottom conduit entry if used with KPST and KPWB mounting hoods.

③ Silicone or Teflon coated globes are available. Contact your local sales representative.

④ Non hazardous rated globes for special applications.

⑤ Certified to meet the Canadian Electrical Code (CEC) only.

Mercmaster™ III Low Profile Compact Fluorescent Luminaires

Enclosed and Gasketed. For Hazardous and Wet Locations

Compact Fluorescent listed for simultaneous exposure to combustible dusts and flammable gases or vapors.

NEC/CEC:







Class I, Division 2, Groups A, B, C, D
Class I, Zone 2, AEx nA nR IIC (Z2)
Class II, Division 1 and 2, Groups E, F, G
Class III

NEC/CEC:

Simultaneous Exposure (Class I, Division 2/
Class II, Division 1)
Fixtures Outside Type (Salt Water)
Type 4X
IP66

CEC:

Class I, Zone 2, Ex nR IIC (Z)

Item	Description	Catalog Number																			
Replacement Optic Gaskets — Silicone rubber																					
	Globe and Polymeric Refractor Gasket	VPGL-GK																			
	Glass Refractor Gasket	KRF-GK																			
Replacement Lamp																					
	Mercmaster III Low Profile Compact Fluorescent																				
	<table border="1"> <thead> <tr> <th>Lamp Type</th> <th>Lamp Base</th> <th>Wattage</th> <th>Catalog Number</th> </tr> </thead> <tbody> <tr> <td>PL-T</td> <td>GX24q-3</td> <td>26</td> <td>PLT26</td> </tr> <tr> <td>PL-T</td> <td>GX24q-3</td> <td>32</td> <td>PLT32</td> </tr> <tr> <td>PL-T</td> <td>GX24q-4</td> <td>42</td> <td>PLT42</td> </tr> <tr> <td>PL-T</td> <td>GX24q-5</td> <td>57</td> <td>PLT57 ③</td> </tr> </tbody> </table>	Lamp Type	Lamp Base	Wattage	Catalog Number	PL-T	GX24q-3	26	PLT26	PL-T	GX24q-3	32	PLT32	PL-T	GX24q-4	42	PLT42	PL-T	GX24q-5	57	PLT57 ③
Lamp Type	Lamp Base	Wattage	Catalog Number																		
PL-T	GX24q-3	26	PLT26																		
PL-T	GX24q-3	32	PLT32																		
PL-T	GX24q-4	42	PLT42																		
PL-T	GX24q-5	57	PLT57 ③																		
Replacement Socket																					
	For 26 W, 32 W and 42 W PLT Lamps listed above	PLT32RS																			
	For 57 W PLT Lamp	PLT57RS ③																			
Three-Way Exit Sign ①																					
	Epoxy enameled steel – 152.4 mm (6”) high red lettering	CJEXRN																			
	Mounts to Globe Ballast Housing in place of guard.																				
Single Sided Exit Sign ①																					
	Epoxy enameled steel – 152.4 mm (6”) high red lettering	AEXR-15R																			
	Mounts to Globe Ballast Housing in place of guard																				
Retrofit Pendant Mounting Adapter																					
	Permits use of Mercmaster III pendant hood with 3/4” hub on existing V-51 mounting hood	LPAD-1																			
Fuse Kit ②																					
	2 Amp time delay fuse	MLF2																			

① Consult your local sales representative for classified area suitability. Not listed for Zone 2 areas.

② Canadian Electrical Code does NOT allow fusing in hazardous locations.

③ Certified to meet the Canadian Electrical Code (CEC) only.

Mercmaster™ III Low Profile Compact Fluorescent Luminaires

Enclosed and Gasketed. For Hazardous and Wet Locations

Compact Fluorescent listed for simultaneous exposure to combustible dusts and flammable gases or vapors.

NEC/CEC:

Class I, Division 2, Groups A, B, C, D
Class I, Zone 2, AEx nA nR IIC (Z2)
Class II, Division 1 and 2, Groups E, F, G
Class III

NEC/CEC:

Simultaneous Exposure (Class I, Division 2/
Class II, Division 1)
Fixtures Outside Type (Salt Water)
Type 4X
IP66

CEC:

Class I, Zone 2, Ex nR IIC (Z)

Line Voltage	Type of Ballast	Starting and Operating Amps	Total Watts
26 Watt PL-T Fluorescent			
120	Electronic	.250	28
277	Electronic	.110	28
347	Electronic	.080	27
32 Watt PL-T Fluorescent			
120	Electronic	.300	36
277	Electronic	.130	36
347	Electronic	.150	36
42 Watt PL-T Fluorescent			
120	Electronic	.410	48
277	Electronic	.180	48
347	Electronic	.140	43
52 Watt PL-T Fluorescent			
120	Electronic	.460	56
277	Electronic	.220	56
347	Electronic	.170	54
57 Watt PL-T Fluorescent ①			
120	Electronic	.480	58
277	Electronic	.210	57
347	Electronic	.180	61
64 Watt PL-T Fluorescent			
120	Electronic	.580	69
277	Electronic	.260	69
347	Electronic	.190	66
84 Watt PL-T Fluorescent			
120	Electronic	.760	91
277	Electronic	.320	91
347	Electronic	.280	86
114 Watt PL-T Fluorescent ①			
120	Electronic	.960	116
277	Electronic	.420	114
347	Electronic	.360	122

Fuse catalog number: MLF2 (1 required for 120 V or 277 V) – 2-Amp fuse, time delay.
Minimum starting temperature: -18 °C (0 °F).

Energy Efficiency and Lamp Life Comparison

Lamp Type	Watts	Lumens	Rated Average Life (Hours)
Incandescent	100	1750	750
Incandescent	150	2880	750
Incandescent	200 (PS-25, PS-30)	3710	750
Incandescent	200 (A-23)	4010	750
PL-T Fluorescent	26	1800	10,000
PL-T Fluorescent	32	2400	10,000
PL-T Fluorescent	42	3200	10,000
PL-T Fluorescent	52	3600	10,000
PL-T Fluorescent	57 ①	4300	12,000
PL-T Fluorescent	64	4800	10,000
PL-T Fluorescent	84	6400	10,000
PL-T Fluorescent	114 ①	8600	12,000

① Certified to meet the Canadian Electrical Code (CEC) only.

Lumen Output Comparison

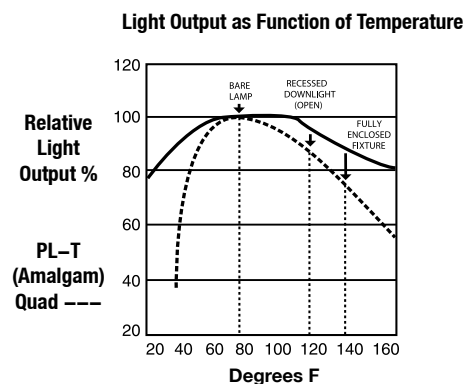

High lumen output of the amalgam technology lamp vs. the reduced light output at variable temperatures from a typical compact fluorescent lamp.

Mercmaster™ III Low Profile Compact Fluorescent Luminaires

Enclosed and Gasketed. For Hazardous and Wet Locations

Compact Fluorescent listed for simultaneous exposure to combustible dusts and flammable gases or vapors.

NEC/CEC:

Class I, Division 2, Groups A, B, C, D
 Class I, Zone 2, AEx nA nR IIC (Z2)
 Class II, Division 1 and 2, Groups E, F, G
 Class III

NEC/CEC:

Simultaneous Exposure (Class I, Division 2)
 Class II, Division 1)
 Fixtures Outside Type (Salt Water)
 Type 4X
 IP66

CEC:

Class I, Zone 2, Ex nR IIC (Z)

Dimensions in Millimeters (Inches)

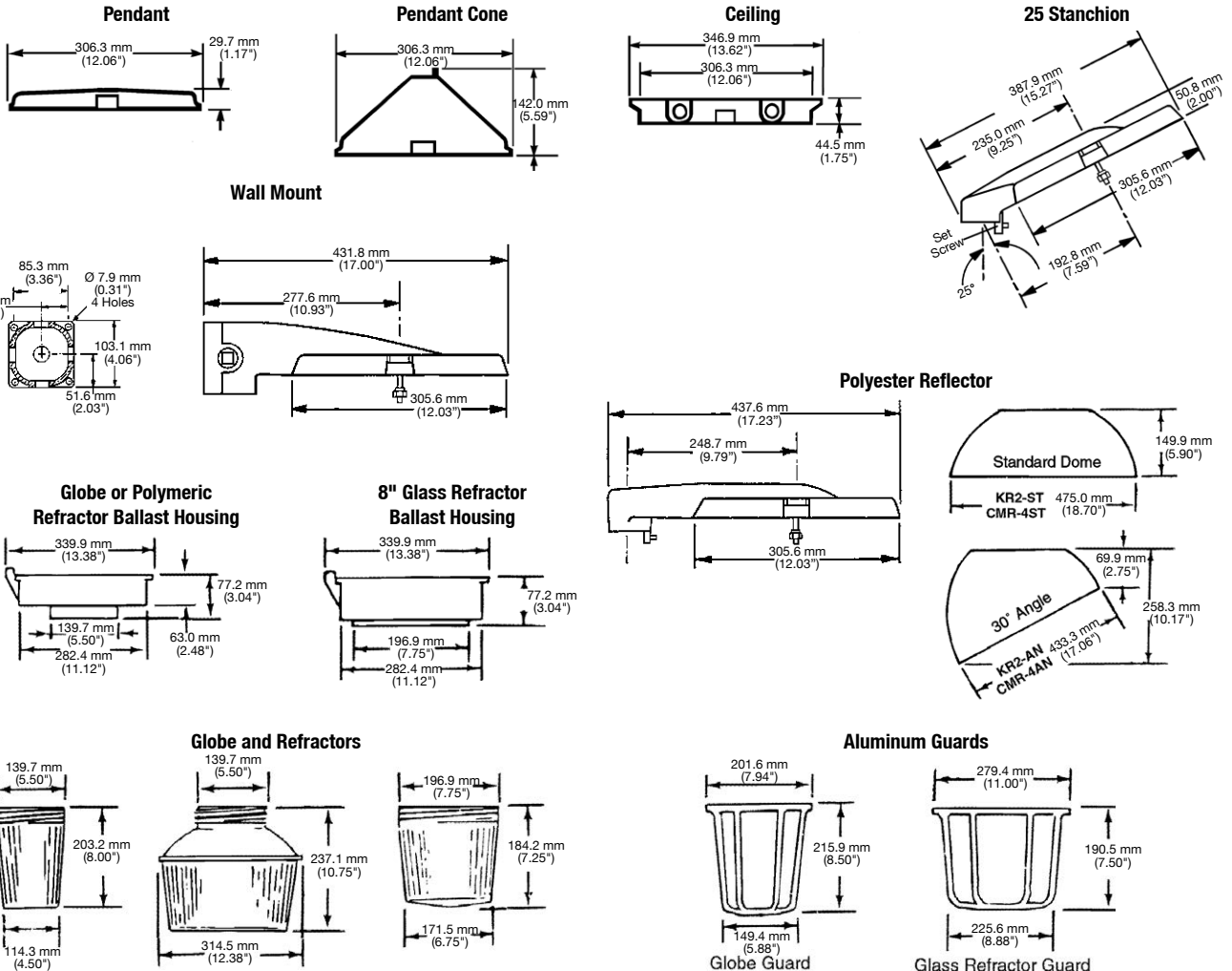

Accessory Weights ①

Ballast Housings and Mounting Hoods	Wt. Kgs (Lbs)	Refractors, Globe, Guards and Reflectors	Wt. Kgs (Lbs)
Pendant	1.0 (2.20)	8" Glass Refractor	2.4 (5.29)
Pendant Cone	1.1 (2.43)	Glass Globe	1.7 (3.75)
Ceiling	1.4 (3.09)	Glass Globe — 57/114 W ③	3.8 (8.38)
Wall Mount	1.8 (3.97)	Polymeric Refractor ②	1.1 (2.43)
25° Stanchion	1.5 (3.31)	Glass Refractor Guard	0.5 (1.10)
90° Stanchion	1.7 (3.75)	Globe Guard	0.5 (1.10)
Globe/Polymeric Refractor Housing	2.5 (5.51)	Globe Guard — 57/114 W ③	0.9 (1.98)
Glass Refractor Housing	2.9 (6.39)	Standard Dome	1.1 (2.43)
		30° Angle	1.1 (2.43)
		Exit Sign ②	2.3 (5.07)

① Weights are approximate.

② Not listed for Class I, Zone 2 areas.

③ Certified to meet the Canadian Electrical Code (CEC) only.

FV Series Nonmetallic Fluorescent Luminaires

For Hazardous and Adverse Locations

NEC/CEC:
Class I, Division 2, Groups A, B, C, D
Class II, Division 2, Groups F, G
Class I, Zone 2, Group IIC

NEC/CEC:
Marine Type Electric Fixture
Outside Type (Salt Water)
Type 4X
Wet Locations

Applications

- For use in hazardous locations defined by the NEC and CEC as Class I, Division 2, Groups A, B, C and D; Class II, Division 2, Groups F and G; Marine Outdoor Salt Water; UL1598A and Type 4X. As well as hazardous locations defined by the CEC as Class I, Zone 2 II C.
- For use in locations where a high degree of corrosion resistance is required.
- For indoor or outdoor use where protection against dirt, water and moisture is necessary.
- Typical applications include oil refineries, petrochemical facilities, pulp and paper mills, food processing plants, warehouses, underground tunnels and general manufacturing facilities.

Features

- Stainless steel hubs (3/4") provided as standard.
- Ballast options for nearly all U.S. and foreign voltage and frequency combinations are available.
- Low operating costs provide more lumens per Watt than incandescent fixtures.
- Impact-resistant polycarbonate lens is hinged to allow easy access to lamp compartment.
- Corrosion-resistant fiberglass reinforced polyester housing.
- Actuator allows access to lamps and ballast compartment – no tools required.
- Latch assembly and elastomer type gasket provide positive seal from water ingress.
- Safety switch (supplied as standard) disconnects power to lamps and ballast when lens is open.
- Reflector is hinged for easy single-handed entry to ballast compartment.
- Actuator can be removed for tamper-resistant applications.

Standard Materials

- Housing: fiberglass reinforced polyester
- Lens: polycarbonate
- Gasket: elastomer
- Hubs: stainless steel
- Lampholders: polycarbonate
- Internal reflector: highly reflective white polycarbonate
- Fixed surface mount: (2) 14-gauge stainless steel
- Adjustable wall mount: (2) copperfree (4/10 of 1% max.) aluminum
- 45° fixed wall mount: (2) 11-gauge (1/8") stainless steel
- Chain ring bolt: set of 2 zinc plated steel (internal diameter .78")

Options

- Individually fused ballast. Add suffix **-F**.
- Terminal block. Add suffix **-T**.
- Emergency battery pack. Add suffix **-EL**.
- Emergency light capability in moments of power interruption. Luminaire automatically switches to emergency mode, keeping one lamp illuminated for a minimum of 90 minutes. When AC power is restored, battery automatically recharges in 24 hours. Initial light output is 600-700 lumens.



NEC/CEC Compliances and Certifications

- UL Standard: UL 1598, UL 844, UL 60079-0, UL 60079-15, Marine Listed UL 1598A ①
- UL Listed: E10794
- CSA Standard: C22.2 No. 250, C22.2 No. 137, CAN E60079-0, CAN E60079-15
- cUL Listed: E10794

① Does not apply to fixtures with fusing.

FV Series Nonmetallic Fluorescent Luminaires

For Hazardous and Adverse Locations

NEC/CEC:
Class I, Division 2, Groups A, B, C, D
Class II, Division 2, Groups F, G



NEC/CEC:
Marine Type Electric Fixture
Outside Type (Salt Water)
Type 4X
Wet Locations

CEC:
Class I, Zone 2, Group IIC

Order using catalog numbering guide below or select catalog number from tables on following pages.

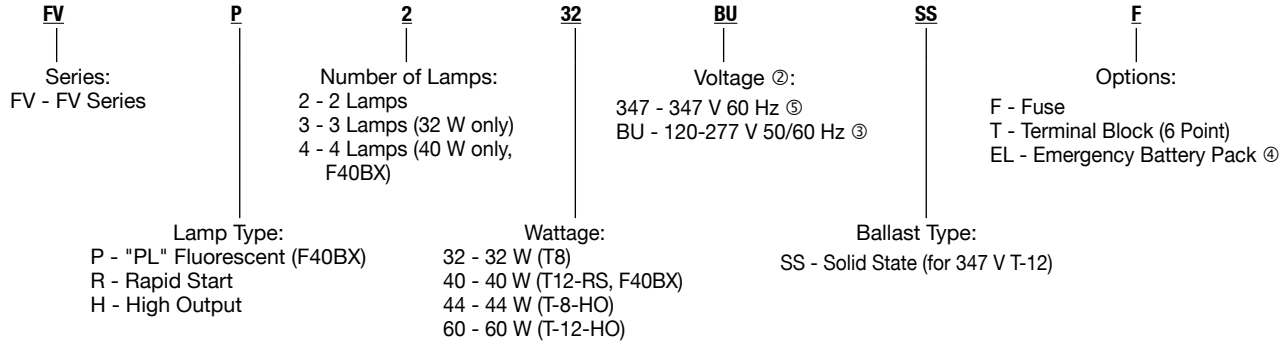
Catalog Numbering Guide For FV Series Nonmetallic Fluorescent Luminaires



	Number of Lamps	Lamp Watts	Lamp Type	Hub Size (Inches)	Overall Fixture Length Millimeters (Inches)	Volts	Catalog Number
	2	40	F40BX	3/4	787.4 (31)	120-277	FVP240BU
	2	40	F40BX	3/4	787.4 (31)	347	FVP240-347 ⑤
	4	40	F40BX	3/4	1397.0 (55)	120-277	FVP440BU
	4	40	F40BX	3/4	1397.0 (55)	347	FVP440-347 ⑤
	2	32	T8	3/4	1397.0 (55)	120-277	FVR232BU
	2	32	T8	3/4	1397.0 (55)	347	FVR232-347S0 ⑤
	2	44	T8-HO	3/4	1397.0 (55)	120-277	FVH244BU
	2	44	T8-HO	3/4	1397.0 (55)	347	FVH244-347S0 ⑤
	2	40	T12	3/4	1397.0 (55)	120-277	FVR240BU
	2	40	T12	3/4	1397.0 (55)	347	FVR240-347SS ⑤
	2	60	T12-HO	3/4	1397.0 (55)	120-277	FVH260BU
	2	60	T12-HO	3/4	1397.0 (55)	347	FVH260-347SS ⑤
	3	32	T8	3/4	1397.0 (55)	120-277	FVR332BU
	3	32	T8	3/4	1397.0 (55)	347	FVR332-347S0 ⑤

Note: BU ballasts are auto-sensing, solid state for any voltage between 120 and 277 V, 50 or 60 Hz.

- ① Does not apply to fixtures with fusing.
- ② Consult factory for availability of specific voltages.
- ③ 32 W SS Octron and F40BX only.
- ④ 4' fixture only.
- ⑤ Certified to meet the Canadian Electrical Code (CEC) only.





FV Series Nonmetallic Fluorescent Luminaires

For Hazardous and Adverse Locations

NEC/CEC:
Class I, Division 2, Groups A, B, C, D
Class II, Division 2, Groups F, G

NEC/CEC:
Marine Type Electric Fixture
Outside Type (Salt Water)
Type 4X
Wet Locations

CEC:
Class I, Zone 2, Group IIC

	Description	Standard Materials	Catalog Number
	Surface Mount (set of 2)	14-gauge stainless steel	FVSM
	Adjustable Wall Mount (set of 2)	Copperfree (4/10 of 1% max.) aluminum	FVWAM
	Fixed 45° Wall Mount (set of 2)	11-gauge (1/8") stainless steel	FVWFM
	Chain Mount (set of 2)	Zinc plated steel M8 ring bolts (chain not provided)	FVCM

Technical Data — Thermal Performance of FV Series Fixtures

For supply connection, use wire rated +75 °C (+167 °F).

Fixture	Quantity	Lamp Watt	Lamp Type	Lamp Lumens	Min. Start Temp °C (°F)	Ambient Temp. °C (°F)	"T" Numbers
FVP240BU	2	40	F40BX	3300	-18 (0)	+40 (+104)	T4
FVP240-347 ②	2	40	F40BX	3300	-18 (0)	+40 (+104)	T4
FVP440BU	4	40	F40BX	3300	-18 (0)	+40 (+104)	T4
FVP440-347 ②	4	40	F40BX	3300	-18 (0)	+40 (+104)	T4
FVR232BU	2	32	T8-RS	2850	-18 (0)	+40 (+104)	T6
FVR232-347S0	2	32	T8-RS	2850	-18 (0)	+40 (+104)	T6
FVH244-BU	2	44	T8-HO	4050	-10 (+14)	+40 (+104)	T6
FVH244-347S0 ②	2	44	T8-HO	4050	-10 (+14)	+40 (+104)	T6
FVR240BU	2	40	T12-RS	3050	-18 (0)	+55 (+131)	T4A
FVR240-347SS ②	2	40	T12-HO	3050	+10 (+50)	+55 (+131)	T4A
FVH260BU	2	60	T12-HO	4050	-28 (-20)	+40 (+104)	T4A
FVH260-347SS ②	2	60	T12-HO	4050	-28 (-20)	+40 (+104)	T4A
FVR332BU	3	32	T8-RS	2850	-18 (0)	+40 (+104)	T6

① Does not apply to fixtures with fusing.

② Certified to meet the Canadian Electrical Code (CEC) only.

FV Series Nonmetallic Fluorescent Luminaires

For Hazardous and Adverse Locations

NEC/CEC:
Class I, Division 2, Groups A, B, C, D
Class II, Division 2, Groups F, G

NEC/CEC:
Marine Type Electric Fixture
Outside Type (Salt Water)
Type 4X
Wet Locations

CEC:
Class I, Zone 2, Group IIC

Dimensions in Millimeters (Inches)

FV Series

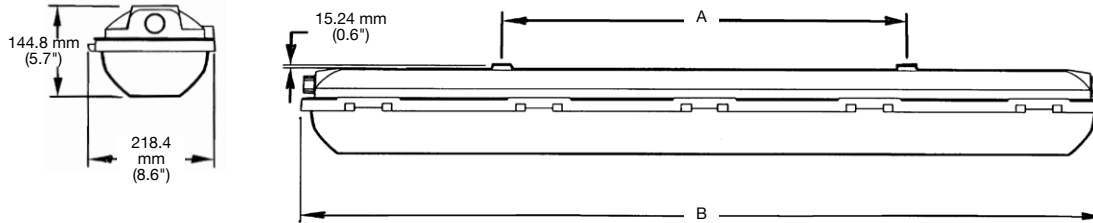

FVWFM

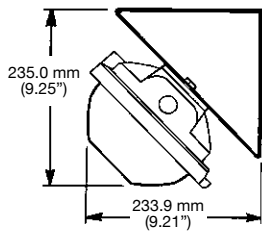

FVWAM

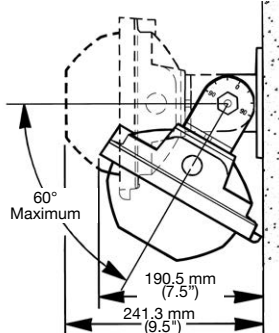

FVSM

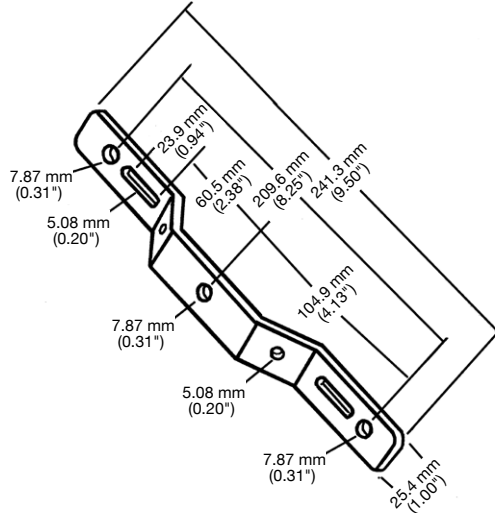

FVCM

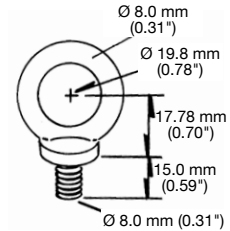

FLUORESCENT/AREA: NEC/CEC ENCLOSED AND GASKETED

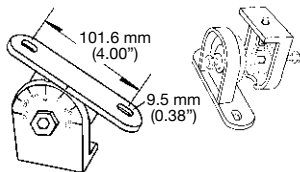
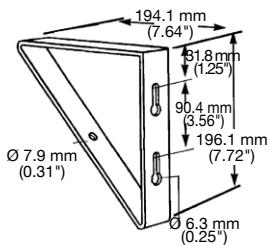

Mounting Centers and Overall Length in Millimeters (Inches)

	A	B
2 Foot Luminaire	401.3 mm (15.80")	787.4 mm (31.00")
4 Foot Luminaire	701.0 mm (27.60")	1397.0 mm (55.00")

FV Series Nonmetallic Fluorescent Luminaire Photometric Data

For Hazardous and Adverse Locations

NEC/CEC:
Class I, Division 2, Groups A, B, C, D
Class II, Division 2, Groups F, G

NEC/CEC:
Marine Type Electric Fixture
Outside Type (Salt Water)
Type 4X
Wet Locations

CEC:
Class I, Zone 2, Group IIC



FLUORESCENT/AREA: NEC/CEC ENCLOSED AND GASKETED

Photometric Data

CIE TYPE - DIRECT

PLANE: 0 DEG. 90 DEG.

SPACING CRITERIA: 1.2 1.5

CANDELA DISTRIBUTION				
	0.0	45.0	90.0	ZONAL LUMENS
0	1705	1705	1705	
5	1701	1698	1687	161
15	1635	1642	1688	468
25	1513	1581	1660	731
35	1324	1492	1623	932
45	1085	1361	1516	1027
55	806	1161	1292	992
65	490	888	1065	836
75	197	644	821	619
85	32	360	497	351
90	12	257	399	

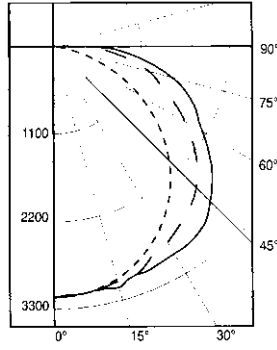

FVP 240, Two 40 W PL Lamps • Total Luminaire Efficiency = 92.7%

% Floors Rfc	% Ceiling Rcc	% Walls Rww	Room Cavity Ratio															
			80				70				20							
			70	50	30	10	70	50	30	10	50	30	10	50	30	10	0	
0	1.10	1.10	1.10	1.10	1.08	1.08	1.08	1.08	1.03	1.03	1.03	.99	.99	.99	.95	.95	.95	.93
1	.99	.93	.89	.84	.96	.91	.87	.83	.87	.83	.80	.83	.80	.78	.80	.78	.75	.73
2	.89	.80	.73	.67	.86	.78	.72	.66	.75	.69	.64	.72	.67	.63	.69	.65	.61	.59
3	.80	.69	.61	.54	.78	.68	.60	.54	.65	.58	.53	.62	.57	.52	.60	.55	.51	.49
4	.73	.61	.52	.45	.71	.60	.51	.44	.57	.50	.44	.55	.49	.44	.53	.48	.43	.41
5	.67	.54	.45	.39	.65	.53	.45	.38	.51	.44	.38	.49	.43	.37	.47	.42	.37	.35
6	.62	.49	.40	.33	.60	.48	.39	.33	.46	.38	.33	.44	.38	.33	.43	.37	.32	.30
7	.57	.44	.35	.29	.55	.43	.35	.29	.42	.34	.29	.40	.34	.29	.39	.33	.28	.26
8	.53	.40	.32	.26	.52	.39	.31	.26	.38	.31	.25	.37	.30	.25	.36	.30	.25	.23
9	.50	.37	.29	.23	.48	.36	.28	.23	.35	.28	.23	.34	.27	.23	.33	.27	.23	.21
10	.46	.34	.26	.21	.45	.33	.26	.21	.32	.25	.21	.31	.25	.21	.30	.24	.20	.19

CIE TYPE - DIRECT

PLANE: 0 DEG. 90 DEG.

SPACING CRITERIA: 1.2 1.5

CANDELA DISTRIBUTION				
	0.0	45.0	90.0	ZONAL LUMENS
0	3152	3152	3152	
5	3139	3138	3130	299
15	3030	3060	3036	868
25	2798	2910	3041	1351
35	2470	2740	2091	1720
45	2043	2517	2760	1897
55	1523	2130	2373	1827
65	941	1656	1976	1553
75	378	1234	1532	1163
85	49	679	901	649
90	10	474	694	

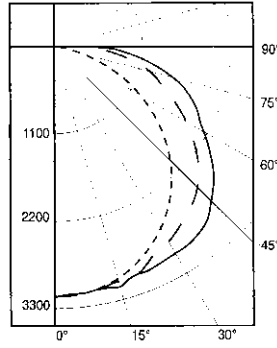

FVP 440, Four 40 W PL Lamps • Total Luminaire Efficiency = 85.8%

% Floors Rfc	% Ceiling Rcc	% Walls Rww	Room Cavity Ratio															
			80				70				20							
			70	50	30	10	70	50	30	10	50	30	10	50	30	10	0	
0	1.02	1.02	1.02	1.02	1.00	1.00	1.00	1.00	.95	.95	.95	.91	.91	.91	.88	.88	.88	.86
1	.99	.93	.89	.84	.96	.91	.87	.83	.87	.83	.80	.83	.80	.78	.80	.78	.75	.73
2	.89	.80	.73	.67	.86	.78	.72	.66	.75	.69	.64	.72	.67	.63	.69	.65	.61	.59
3	.74	.64	.56	.50	.72	.63	.56	.50	.60	.54	.49	.58	.52	.48	.55	.51	.47	.45
4	.68	.56	.48	.42	.66	.55	.48	.42	.53	.46	.41	.51	.45	.40	.49	.44	.40	.38
5	.62	.50	.42	.36	.60	.49	.41	.35	.47	.40	.35	.46	.39	.35	.44	.39	.44	.32
6	.57	.45	.37	.31	.55	.44	.36	.31	.42	.36	.30	.41	.35	.30	.40	.34	.30	.28
7	.53	.41	.33	.27	.51	.40	.32	.27	.38	.32	.27	.37	.31	.26	.36	.30	.26	.24
8	.49	.37	.29	.24	.48	.36	.29	.24	.35	.28	.24	.34	.28	.24	.33	.27	.23	.22
9	.46	.34	.26	.21	.45	.33	.26	.21	.32	.26	.21	.31	.25	.21	.30	.25	.21	.19
10	.43	.31	.24	.19	.42	.31	.24	.19	.30	.23	.19	.29	.23	.19	.28	.23	.19	.175

CIE TYPE - DIRECT

PLANE: 0 DEG. 90 DEG.

SPACING CRITERIA: 1.2 1.5

CANDELA DISTRIBUTION				
	0.0	45.0	90.0	ZONAL LUMENS
0	1101	1101	1101	
5	1098	1098	1097	104
15	1056	1069	1085	303
25	976	1026	1093	477
35	856	985	1096	616
45	710	928	1075	703
55	528	830	986	709
65	328	681	849	636
75	132	567	757	530
85	14	340	499	332
90	4	252	397	

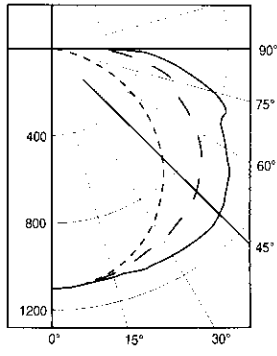

FVR 232, Two T8 32 W Lamps* • Total Luminaire Efficiency = 77.4%

% Floors Rfc	% Ceiling Rcc	% Walls Rww	Room Cavity Ratio															
			80				70				20							
			70	50	30	10	70	50	30	10	50	30	10	50	30	10	0	
0	.92	.92	.92	.92	.90	.90	.90	.90	.86	.86	.86	.82	.82	.82	.79	.79	.79	.77
1	.81	.77	.72	.68	.79	.75	.71	.67	.71	.68	.65	.68	.66	.63	.65	.63	.61	.59
2	.73	.65	.59	.53	.71	.64	.58	.53	.61	.56	.51	.58	.54	.50	.56	.52	.49	.47
3	.65	.56	.49	.44	.63	.55	.49	.43	.53	.47	.43	.51	.46	.42	.49	.45	.41	.39
4	.60	.49	.42	.36	.58	.48	.41	.35	.46	.40	.35	.44	.39	.34	.42	.38	.34	.32
5	.55	.44	.37	.31	.53	.43	.36	.31	.41	.35	.31	.40	.34	.30	.38	.34	.30	.28
6	.50	.39	.31	.26	.49	.38	.31	.26	.35	.30	.26	.35	.30	.25	.34	.29	.25	.23
7	.47	.35	.28	.23	.45	.35	.28	.23	.33	.27	.22	.32	.26	.22	.31	.26	.22	.20
8	.43	.32	.25	.20	.42	.31	.25	.20	.30	.24	.20	.29	.24	.20	.28	.23	.19	.18
9	.40	.29	.22	.18	.39	.29	.22	.18	.28	.22	.18	.27	.21	.18	.26	.21	.17	.16
10	.38	.27	.20	.16	.37	.26	.20	.16	.26	.20	.16	.25	.20	.16	.24	.19	.16	.14

CIE TYPE - DIRECT

PLANE: 0 DEG. 90 DEG.

SPACING CRITERIA: 1.2 1.4

CANDELA DISTRIBUTION				
	0.0	45.0	90.0	ZONAL LUMENS
0	1780	1780	1780	169
5	1767	1773	1771	169
15	1700	1732	1757	490
25	1574	1661	1734	767
35	1388	1554	1652	1064
45	1150	1388	1556	1064
55	860	12001	3671	038
65	53	6949	1116	881
75	214	698	914	675
85	21	443	637	426
90	7	319	491	

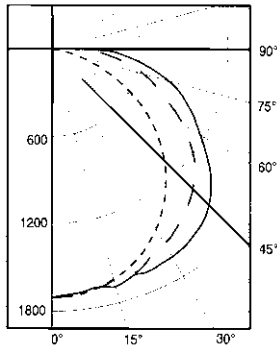

FVR 332, Three T8 32 W Lamps • Total Luminaire Efficiency = 75.7%

% Floors Rfc	% Ceiling Rcc	% Walls Rww	Room Cavity Ratio															
			80				70				20							
			70	50	30	10	70	50	30	10	50	30	10	50	30	10	0	
0	.90	.90	.90	.90	.88	.88	.88	.88	.84	.84	.84	.81	.81	.81	.77	.77	.77	.76
1	.80	.76	.72	.68	.78	.74	.70	.67	.71	.68	.65	.68	.65	.63	.65	.63	.61	.59
2	.72	.65	.59	.54	.70	.63	.58	.53	.61	.56	.52	.58	.54	.51	.56	.52	.50	.48
3	.65	.56	.49	.44	.63	.55	.49	.43	.53	.47	.43	.51	.46	.42	.49	.45	.41	.39
4	.60	.50	.42	.37	.58	.48	.42	.36	.47	.41	.36	.45	.39	.35	.43	.38	.35	.33
5	.55	.44	.37	.31	.53	.43	.36	.31	.41	.35	.31	.40	.34	.30	.38	.34	.30	.28
6	.50	.39	.32	.27	.49	.39	.32	.27	.37	.31	.27	.36	.30	.26	.35	.30	.26	.24
7	.46	.36	.29	.24	.45	.35	.28	.23	.34	.28	.23	.33	.27	.23	.32	.27	.23	.21
8	.43	.32	.26	.21	.42	.32	.25	.21	.31	.25	.21	.30	.24	.21	.29	.24	.20	.19
9	.40	.30	.23	.19	.39	.29	.23	.19	.28	.23	.19	.27	.22	.18	.27	.22	.18	.17
10	.38	.27	.21	.17	.37	.27	.21	.17	.26	.21	.17	.25	.20	.17	.25	.20	.17	.15

FR, FZ and FD Luminaires

Nonmetallic Fluorescent

4 foot, 2 lamp fixtures. High-impact fiberglass reinforced polyester fixtures suitable for use in wet and damp locations.

NEC/CEC — FR Series

Wet Locations

IP65 when used with optional polycarbonate lens

NEC/CEC — FZ Series

Class I, Zone 2, IIC

AEx nA IIC T5 IP65
Ex nA IIC T5 IP65

NEC/CEC — FD Series

Class I, Division 2, Groups A, B, C, D

Class I, Zone 2, IIC

Applications

- For use in locations where a high degree of corrosion resistance is required.
- FR Series:
 - For use in areas where high humidity or water vapor are present
 - Typical uses include meat- or food-processing plants, dairy or drug plants, breweries, kitchens, chemical plants, car washes, laundries and parking garages.
 - Can be used indoors or outdoors in protected locations (wet locations).
 - Operates safely in 38 °C (100 °F) ambient temperature areas.
- FZ and FD Series:
 - For use in hazardous locations defined by the NEC as Class I, Division 2; and Class I, Zone 2.
 - For wet-location use where protection against dirt, water and moisture is necessary.
 - Typical applications include oil refineries, petrochemical facilities, pulp and paper mills, food-processing plants, warehouses, underground tunnels and general manufacturing facilities.
- FZ Series is UL Listed for Class I, Zone 2.
- FD Series fixture is UL listed for Class I, Division 2.

Features

- Fixtures are available with ballasts to support T12 and T8 lamps for nearly all U.S. and foreign voltage and frequency combinations.
- Low operating costs provide more lumens per Watt than incandescent fixtures.
- Housing is smooth, seamless, one-piece injection molded.
- Lens comes in high-impact polycarbonate plastic or impact-resistant acrylic.
- Fixtures are washable, non-conductive and corrosion-resistant.
- Enclosure is rated at IP65 (using polycarbonate lens), dust-proof and protected against water spray.
- A compressible, one-piece, non-thixotropic polyol gasket is bonded to the housing around the entire perimeter. It forms a continuous tight seal with the lens to keep out dirt, vapor and moisture.
- Lens is securely clamped to fixture using six captive corrosion-proof molded celcon tension latches. Lens is impact-resistant acrylic to protect lamps against breakage, and protect work area from broken lamp glass.
- Electrical components are mounted on a metallic wireway. Reflector is supported by internal safety springs to simplify installation and servicing.
- Optional fusing protects circuitry against occasional line voltage spikes.
- FR Series fixtures are available with one or two watertight 1/2" hubs for electrical-feed mounting or single-entry mounting.
- FZ fixtures are available with either 1/2" NPT or cable gland entries.
 - Cable glands are not available with FD series.

Standard Materials

- Housing: fiberglass reinforced polyester
- Lens: polycarbonate or acrylic. (Fixture has IP65 rating with polycarbonate lens.) Acrylic lens supplied as standard
- Latches: celcon
- Ceiling mounting bracket: stainless steel
- Adjustable wall mount: copperfree (4/10 of 1% max.) aluminum
- Fixed wall mount: stainless steel



Illustrated Features

Non-thixotropic polyol gasket is bonded to housing. With plastic latches closed, it forms a continuous, tight seal with lens. Keeps out moisture, vapor and dirt. Allows fast, easy fixture washing.

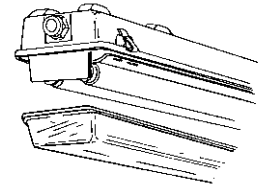

- Chain mount: zinc plated steel
- Gasket: non-thixotropic polyol
- Hubs: zinc plated steel with neoprene o-ring
- Lampholders: polycarbonate

Standard Finishes

- Housing: white color finish
- Celcon latches: white color finish
- Adjustable wall mount: epoxy powder coat

Options:

- Add Suffix **-F** for Fused
- Add Suffix **-T** for Terminal Blocks
- Add Suffix **-P** for Polycarbonate Lens for IP65 Rating
- Add Suffix **-E** for Emergency Battery Pack capability in moments of power interruption. Luminaire automatically switches to emergency mode, keeping two lamps illuminated for a minimum of 90 minutes. When AC power is restored, battery automatically recharges in 24 hours. Initial light output is 600-700 lumens.

NEC/CEC Compliances and Certifications

- FR Series:
 - UL Standard: UL 1598
 - UL Listed: E187946
 - CSA Standard: C22.2 No. 250
 - cUL Listed: E187946
- FZ Series:
 - UL Standard: UL 1598, UL 844, UL 60079-0, UL 60079-15
 - UL Listed: E10794
 - CSA Standard: C22.2 No. 250, C22.2 No. 137, CAN E60079-0, CAN E60079-15
 - cUL Listed: E10794
- FD Series:
 - UL Standard: UL 1598, UL 844
 - UL Listed: E10794
 - CSA Standard: C22.2 No. 250, C22.2 No. 137
 - cUL Listed: E10794

FR, FZ and FD Luminaires

Nonmetallic Fluorescent

4 foot, 2 lamp fixtures. High-impact fiberglass reinforced polyester fixtures suitable for use in wet and damp locations.

NEC/CEC — FR Series

Wet Locations
IP65 when used with optional polycarbonate lens

NEC/CEC — FZ Series

Class I, Zone 2, IIC
AEx nA IIC T5 IP65
Ex nA IIC T5 IP65

NEC/CEC — FD Series

Class I, Division 2, Groups A, B, C, D
Class I, Zone 2, IIC

Order using catalog numbering guide below.

Catalog Numbering Guide For FR, FZ And FD Nonmetallic Fluorescent Lighting Fixtures

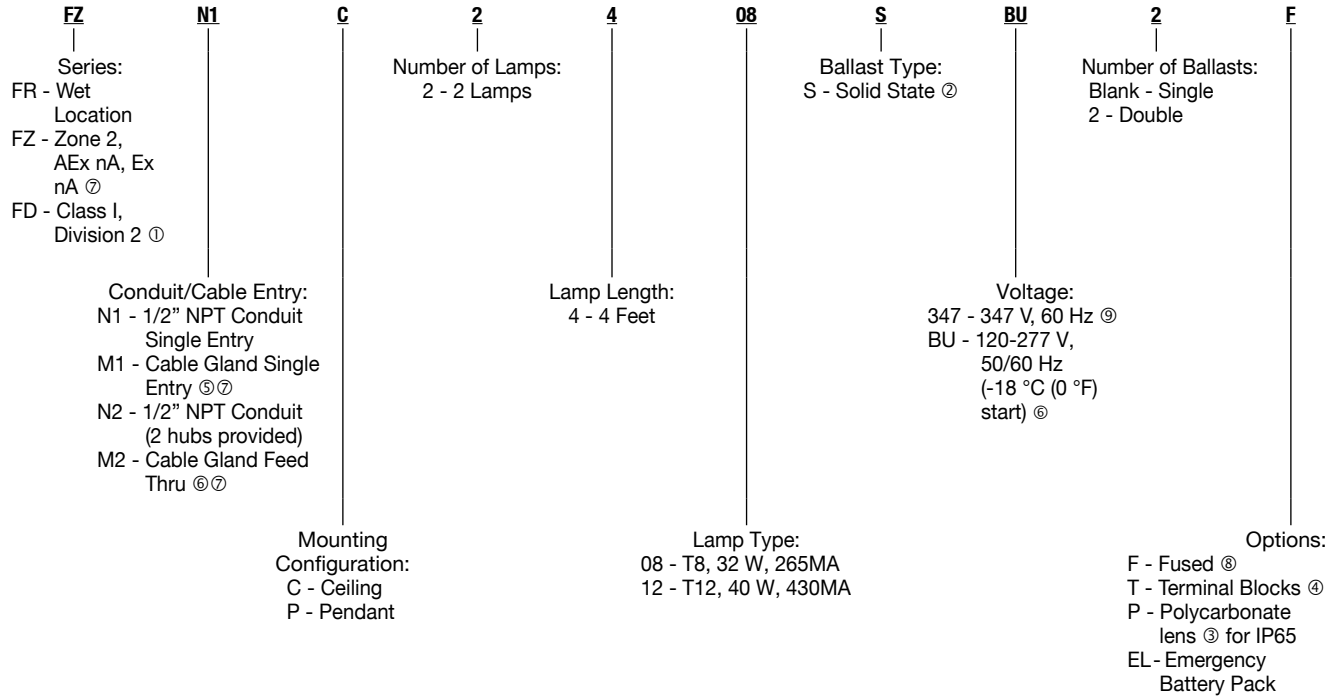

① Fixture is not available with M1 or M2 cable entry options

② Cold weather standard for T8.

③ Use polycarbonate lens for IP65 rating. Polycarbonate lens is standard on FZ Series.

④ Standard equipment for FZ series

⑤ Fixture will be supplied with a 1.5 m (5') length of #14/3 cord and 3 prong plug (120 V) pre-installed when ordered with cable gland. Fixture with cable gland can only be used with hook and chain mounting.

⑥ T8-RS only.

⑦ FZ Series fixtures are not UL Listed for Class I, Division 2 when used with cable glands. FZ Series fixtures are UL Classified for Class I, Zone 2 when used with cable glands.

⑧ Canadian Electrical Code does NOT allow fusing in hazardous locations.

⑨ Certified to meet the Canadian Electrical Code (CEC) only.

FR, FZ and FD Luminaires

Nonmetallic Fluorescent

4 foot, 2 lamp fixtures. High-impact fiberglass reinforced polyester fixtures suitable for use in wet and damp locations.

NEC/CEC — FR Series

Wet Locations

IP65 when used with optional polycarbonate lens

NEC/CEC — FZ Series







Class I, Zone 2, IIC

AEx nA IIC T5 IP65
Ex nA IIC T5 IP65

NEC/CEC — FD Series

Class I, Division 2, Groups A, B, C, D

Class I, Zone 2, IIC

Item	Description	Catalog Number
	1/2" NPT watertight conduit hub	FHUB
	Cable gland	FGLAND
	32 W (T8) and 40 W (T12) lampholder	FS0C40
	Standard plastic clips	FPCLIP
	Acrylic lens cover	FLENS
	Polycarbonate lens cover ①	FPLENS
Ceiling Mounting Bracket (Supplied standard with product)		
	Stainless steel bracket with mounting hardware (set of 2)	FBRACKET
Fixed 45° Wall Mount		
	11 gauge (1/8") stainless steel (set of 2)	FWWFM

① Polycarbonate lens standard for FZ series. When used with FD series, fixture has an IP65 rating.

FR, FZ and FD Luminaires

Nonmetallic Fluorescent

4 foot, 2 lamp fixtures. High-impact fiberglass reinforced polyester fixtures suitable for use in wet and damp locations.

NEC/CEC — FR Series

Wet Locations
IP65 when used with optional polycarbonate lens

NEC/CEC — FZ Series

Class I, Zone 2, IIC
AEx nA IIC T5 IP65
Ex nA IIC T5 IP65

NEC/CEC — FD Series

Class I, Division 2, Groups A, B, C, D
Class I, Zone 2, IIC

Dimensions in Millimeters (Inches)

View of Fixture Cover

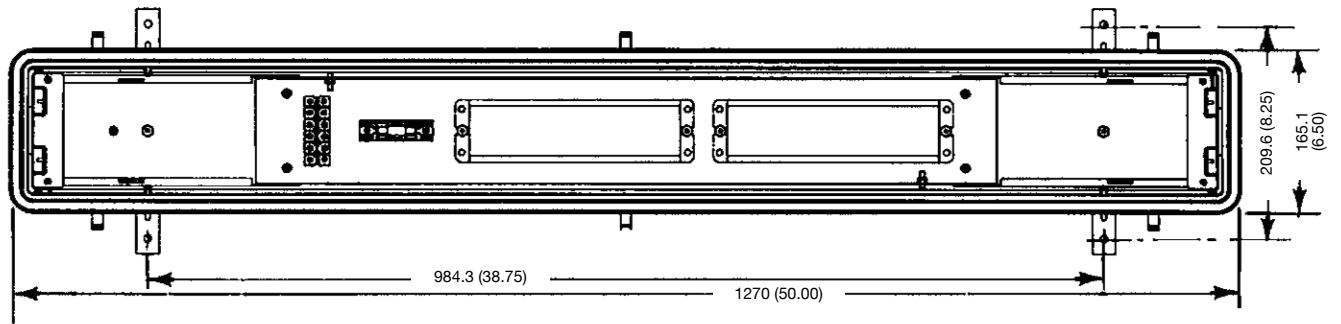

Side View

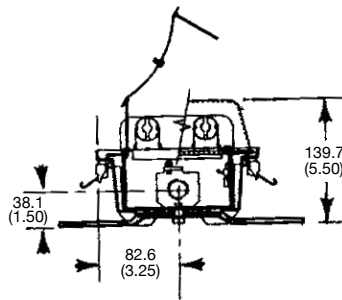

Fixed 45° Wall Mount — FVWFM

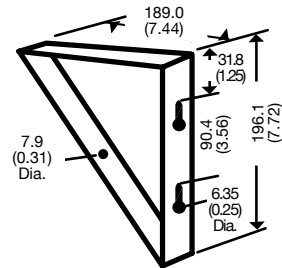

View of Fixture Mounting

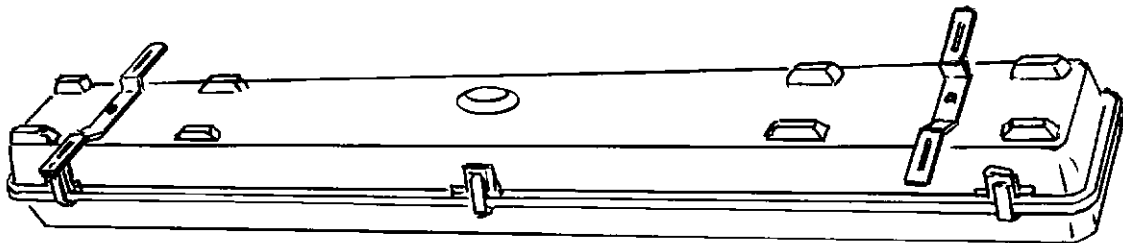

FR, FZ and FD Luminaires

Nonmetallic Fluorescent

4 foot, 2 lamp fixtures. High-impact fiberglass reinforced polyester fixtures suitable for use in wet and damp locations.

NEC/CEC — FR Series
Wet Locations
IP65 when used with optional polycarbonate lens

NEC/CEC — FZ Series
Class I, Zone 2, IIC
AEx nA IIC T5 IP65
Ex nA IIC T5 IP65

NEC/CEC — FD Series
Class I, Division 2, Groups A, B, C, D
Class I, Zone 2, IIC

Photometric Data

CANDELA DISTRIBUTION						TOTAL LUMINAIRE EFFICIENCY = 84.6%
0.0	22.5	45.0	67.5	90.0	Flux	CIE Type – Semi-Direct
0	1155	1155	1155	1155	1155	Plane: 0° 90°
5	1159	1153	1150	1148	1148	Spacing Criteria: 1.3 1.5
15	1118	1118	1124	1134	1137	Shielding Angles: 1 0
25	1036	1049	1071	1109	1125	
35	918	945	1010	1087	1114	
45	766	812	927	1026	1056	
55	569	652	788	900	927	
65	342	450	598	719	753	
75	148	259	432	567	604	
85	25	133	318	444	473	
90	4	98	270	376	412	
95	5	84	258	372	414	
105	2	42	182	292	341	
115	0	13	69	139	182	
125	0	3	22	36	50	
135	0	0	9	15	19	
145	0	0	2	7	9	
155	0	0	0	0	2	
165	0	0	0	0	0	
175	0	0	0	0	0	
180	0	0	0	0	0	

ZONAL LUMEN SUMMARY

ZONE	LUMENS
0-30	926
0-40	1562
0-60	2962
0-90	4282
90-120	509
90-130	529
90-150	538
90-180	539
0-180	4820

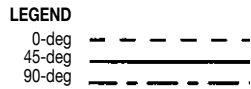
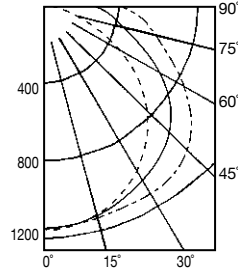

REPORT NUMBER: ITL 47240

Lamps: Two 32 W, 4-foot F32T8/TL735 fluorescents, 2850 lumens per lamp with acrylic lens.

COEFFICIENTS OF UTILIZATION – ZONAL CAVITY METHOD

EFFECTIVE FLOOR CAVITY REFLECTANCE 0.20

% Ceiling RC	% Walls RW	80		70		50		30		10		0							
		70	50	30	10	70	50	30	10	50	30	10	0						
0	0	.98	.98	.98	.98	.95	.95	.95	.95	.89	.89	.89	.83	.83	.83	.78	.78	.78	.75
1	0	.88	.88	.78	.74	.84	.80	.76	.72	.75	.71	.68	.70	.67	.65	.65	.63	.61	.58
2	0	.79	.71	.65	.59	.76	.69	.63	.58	.64	.59	.55	.60	.56	.52	.56	.52	.50	.47
3	0	.71	.62	.54	.48	.68	.60	.53	.47	.56	.50	.45	.52	.47	.43	.49	.45	.41	.39
4	0	.65	.54	.46	.40	.62	.52	.45	.39	.49	.43	.38	.46	.41	.36	.43	.38	.35	.32
5	0	.60	.48	.40	.34	.57	.47	.39	.33	.44	.37	.32	.41	.35	.31	.38	.34	.30	.28
6	0	.55	.43	.35	.29	.53	.42	.34	.29	.39	.33	.28	.37	.31	.27	.35	.30	.26	.24
7	0	.51	.39	.31	.26	.49	.38	.30	.25	.36	.29	.24	.33	.28	.24	.32	.27	.23	.21
8	0	.47	.35	.28	.23	.45	.34	.27	.22	.32	.26	.22	.31	.25	.21	.29	.24	.20	.19
9	0	.44	.32	.25	.20	.42	.31	.25	.20	.30	.24	.19	.28	.23	.19	.27	.22	.18	.17
10	0	.41	.30	.23	.18	.40	.29	.22	.18	.27	.22	.17	.26	.21	.17	.25	.20	.16	.15

FLUORESCENT/AREA: NEC/CEC ENCLOSED AND GASKETED



CANDELA DISTRIBUTION						TOTAL LUMINAIRE EFFICIENCY = 83.6%
0.0	22.5	45.0	67.5	90.0	Flux	CIE Type – Semi-Direct
0	566	566	566	566	566	Plane: 0° 90°
5	568	565	564	563	563	Spacing Criteria: 1.3 1.5
15	548	549	550	554	555	Shielding Angles: 1 0
25	506	512	523	543	552	
35	448	461	495	535	549	
45	374	396	458	509	525	
55	283	324	399	457	475	
65	177	241	318	393	409	
75	72	142	211	259	267	
85	6	63	150	212	228	
90	1	46	118	167	186	
95	1	43	122	176	198	
105	0	20	84	131	154	
115	0	5	33	74	92	
125	0	1	10	18	24	
135	0	0	5	9	10	
145	0	0	1	4	5	
155	0	0	0	1	1	
165	0	0	0	0	0	
175	0	0	0	0	0	
180	0	0	0	0	0	

ZONAL LUMEN SUMMARY

ZONE	LUMENS
0-30	453
0-40	765
0-60	1464
0-90	2126
90-120	241
90-130	251
90-150	256
90-180	256
0-180	2383

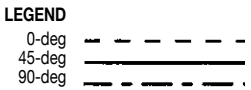
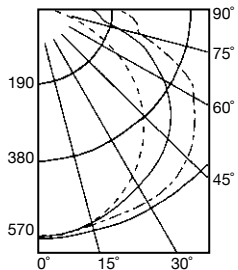
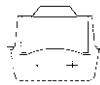

REPORT NUMBER: ITL 47241

Lamps: Two 32 W, 4-foot F32T8/TL735 fluorescents, 2850 lumens per lamp with polycarbonate lens.

COEFFICIENTS OF UTILIZATION – ZONAL CAVITY METHOD

EFFECTIVE FLOOR CAVITY REFLECTANCE 0.20

% Ceiling RC	% Walls RW	80		70		50		30		10		0							
		70	50	30	10	70	50	30	10	50	30	10	0						
0	0	.97	.97	.97	.97	.94	.94	.94	.94	.88	.88	.88	.82	.82	.82	.77	.77	.77	.75
1	0	.87	.82	.78	.74	.84	.79	.75	.72	.74	.71	.68	.69	.67	.64	.65	.63	.61	.58
2	0	.78	.70	.64	.58	.75	.68	.62	.57	.63	.59	.54	.59	.55	.52	.55	.52	.49	.47
3	0	.71	.61	.53	.48	.68	.59	.52	.47	.55	.49	.45	.52	.47	.43	.48	.44	.41	.38
4	0	.64	.54	.46	.40	.62	.52	.44	.39	.48	.42	.37	.45	.40	.36	.43	.38	.34	.32
5	0	.59	.47	.39	.34	.56	.46	.39	.33	.43	.37	.32	.40	.35	.31	.38	.33	.29	.27
6	0	.54	.42	.35	.29	.52	.41	.34	.28	.39	.32	.27	.36	.31	.27	.34	.29	.26	.24
7	0	.50	.38	.31	.25	.48	.37	.30	.25	.35	.29	.24	.33	.27	.23	.31	.26	.22	.21
8	0	.46	.35	.27	.22	.45	.34	.27	.22	.32	.26	.21	.30	.25	.21	.28	.24	.20	.18
9	0	.43	.32	.25	.20	.42	.31	.24	.20	.29	.23	.19	.28	.22	.18	.26	.21	.18	.16
10	0	.41	.29	.22	.18	.39	.28	.22	.18	.27	.21	.17	.26	.20	.17	.24	.20	.16	.15



FR, FZ and FD Luminaires

Nonmetallic Fluorescent

4 foot, 2 lamp fixtures. High-impact fiberglass reinforced polyester fixtures suitable for use in wet and damp locations.

NEC/CEC — FR Series
Wet Locations
IP65 when used with optional polycarbonate lens

NEC/CEC — FZ Series
Class I, Zone 2, IIC
AEx nA IIC T5 IP65
Ex nA IIC T5 IP65

NEC/CEC — FD Series
Class I, Division 2, Groups A, B, C, D
Class I, Zone 2, IIC

Photometric Data

CANDELA DISTRIBUTION						TOTAL LUMINAIRE EFFICIENCY = 80.7%
0.0	22.5	45.0	67.5	90.0	Flux	CIE Type – Semi-Direct
0	1224	1224	1224	1224	1224	Plane: 0° 90°
5	1228	1223	1221	1219	1218	116 Spacing Criteria: 1.3 1.5
15	1185	1190	1204	1219	1222	341 Shielding Angles: 1 0
25	1097	1122	1158	1200	1214	535
35	974	1020	1090	1166	1192	683
45	811	881	993	1094	1122	759
55	600	701	837	943	967	729
65	358	476	625	736	761	595
75	154	271	443	566	600	441
85	25	136	325	455	490	321
90	5	101	285	401	442	
95	5	84	260	372	415	253
105	2	45	187	294	343	184
115	0	14	85	163	204	91
125	0	3	23	53	81	28
135	0	0	9	16	20	7
145	0	0	0	5	7	2
155	0	0	0	0	0	0
165	0	0	0	0	0	0
175	0	0	0	0	0	0
180	0	0	0	0	0	0

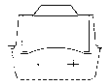

ZONAL LUMEN SUMMARY

ZONE	LUMENS
0-30	992
0-40	1676
0-60	3164
0-90	4521
90-120	528
90-130	556
90-150	564
90-180	564
0-180	5085

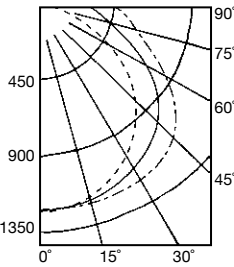

LEGEND

- 0-deg (dashed line)
- 45-deg (solid line)
- 90-deg (dash-dot line)

REPORT NUMBER: **ITL 47242**

Lamps: Two 40 W, 4-foot F40WW fluorescents, 3150 lumens per lamp with acrylic lens.

COEFFICIENTS OF UTILIZATION – ZONAL CAVITY METHOD

EFFECTIVE FLOOR CAVITY REFLECTANCE 0.20

% Ceiling RC	% Walls RW	EFFECTIVE FLOOR CAVITY REFLECTANCE 0.20																	
		80		70		50		30		10		0							
0	1	70	50	30	10	70	50	30	10	50	30	10	50	30	10	0			
0	0	.94	.94	.94	.94	.91	.91	.91	.91	.85	.85	.85	.79	.79	.79	.74	.74	.74	.72
1	1	.84	.79	.75	.71	.81	.76	.73	.69	.71	.68	.65	.67	.64	.62	.62	.60	.58	.56
2	2	.76	.68	.62	.57	.72	.66	.60	.55	.61	.57	.53	.57	.53	.50	.54	.50	.48	.45
3	3	.68	.59	.52	.46	.66	.57	.51	.45	.53	.48	.43	.50	.45	.41	.47	.43	.40	.37
4	4	.62	.52	.44	.39	.60	.50	.43	.38	.47	.41	.36	.44	.39	.35	.41	.37	.33	.31
5	5	.57	.46	.39	.33	.55	.45	.38	.32	.42	.36	.31	.39	.34	.30	.37	.32	.29	.27
6	6	.53	.41	.34	.28	.50	.40	.33	.28	.38	.32	.27	.35	.30	.26	.33	.29	.25	.23
7	7	.49	.37	.30	.25	.47	.36	.29	.24	.34	.28	.24	.32	.27	.23	.30	.26	.22	.20
8	8	.45	.34	.27	.22	.43	.33	.26	.22	.31	.25	.21	.29	.24	.20	.28	.23	.20	.18
9	9	.42	.31	.24	.20	.40	.30	.24	.19	.29	.23	.19	.27	.22	.18	.26	.21	.18	.16
10	10	.39	.28	.22	.18	.38	.28	.22	.17	.26	.21	.17	.25	.20	.16	.24	.19	.16	.14

CANDELA DISTRIBUTION						TOTAL LUMINAIRE EFFICIENCY = 78.9%
0.0	22.5	45.0	67.5	90.0	Flux	CIE Type – Semi-Direct
0	1188	1188	1188	1188	1188	Plane: 0° 90°
5	1188	1186	1186	1184	1183	113 Spacing Criteria: 1.3 1.5
15	1146	1155	1165	1177	1181	330 Shielding Angles: 1 0
25	1060	1085	1122	1165	1178	519
35	940	984	1055	1135	1161	663
45	782	850	970	1073	1102	738
55	589	687	836	950	977	725
65	367	500	652	765	791	618
75	145	293	437	548	563	431
85	12	132	306	428	464	302
90	4	106	270	381	421	
95	5	86	244	348	389	240
105	2	42	178	278	321	172
115	0	8	82	163	201	88
125	0	1	19	54	82	27
135	0	0	8	16	18	6
145	0	0	1	5	8	2
155	0	0	0	0	0	0
165	0	0	0	0	0	0
175	0	0	0	0	0	0
180	0	0	0	0	0	0

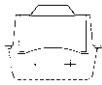

ZONAL LUMEN SUMMARY

ZONE	LUMENS
0-30	961
0-40	1624
0-60	3087
0-90	4438
90-120	500
90-130	527
90-150	535
90-180	535
0-180	4973

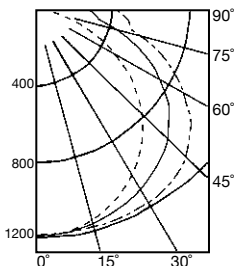

LEGEND

- 0-deg (dashed line)
- 45-deg (solid line)
- 90-deg (dash-dot line)

REPORT NUMBER: **ITL 47243**

Lamps: Two 40 W, 4-foot F40WW fluorescents, 3150 lumens per lamp with polycarbonate lens.

COEFFICIENTS OF UTILIZATION – ZONAL CAVITY METHOD

EFFECTIVE FLOOR CAVITY REFLECTANCE 0.20

% Ceiling RC	% Walls RW	EFFECTIVE FLOOR CAVITY REFLECTANCE 0.20																	
		80		70		50		30		10		0							
0	1	70	50	30	10	70	50	30	10	50	30	10	50	30	10	0			
0	0	.92	.92	.92	.92	.89	.89	.89	.89	.83	.83	.83	.78	.78	.78	.73	.73	.73	.70
1	1	.82	.78	.74	.70	.79	.75	.71	.68	.70	.67	.64	.65	.63	.61	.61	.59	.57	.55
2	2	.74	.67	.61	.55	.71	.64	.59	.54	.60	.55	.52	.56	.52	.49	.53	.49	.47	.44
3	3	.67	.58	.51	.45	.64	.56	.49	.44	.52	.47	.42	.49	.44	.41	.46	.42	.39	.37
4	4	.61	.51	.43	.38	.58	.49	.42	.37	.46	.40	.35	.43	.38	.34	.40	.36	.33	.31
5	5	.56	.45	.38	.32	.53	.44	.37	.31	.41	.35	.30	.38	.33	.29	.36	.32	.28	.26
6	6	.51	.40	.33	.28	.49	.39	.32	.27	.37	.31	.26	.35	.29	.25	.33	.28	.24	.23
7	7	.47	.36	.29	.24	.46	.35	.29	.24	.33	.27	.23	.31	.26	.22	.30	.25	.21	.20
8	8	.44	.33	.26	.21	.42	.32	.26	.21	.30	.25	.20	.29	.23	.20	.27	.23	.19	.17
9	9	.41	.30	.24	.19	.39	.29	.23	.19	.28	.22	.18	.26	.21	.18	.25	.20	.17	.16
10	10	.38	.28	.21	.17	.37	.27	.21	.17	.26	.20	.16	.24	.19	.16	.23	.19	.15	.14

RigMaster™ Metallic Fluorescent Luminaires

For Hazardous and Adverse Locations

Suitable for Use in Wet Locations. 32 W, 40 W and 60 W Two-Lamp Fixtures.

NEC:

Class I, Division 2, Groups A, B, C, D

NEMA Type 4X

Marine Type Electric Fixture Non-Recessed

Outside Type (Salt Water) ①②

Applications

- Enclosed and gasketed fixtures for use where vapors, moisture, dirt or corrosive atmospheres are encountered.
- For use in hazardous locations defined by the NEC as Class I, Division 2. Groups A, B, C and D; Marine Type Electric Fixture Non-Recessed Outside Type (Salt Water); UL1598A; and Type 4X.
- For use in locations where a high degree of corrosion resistance is required.
- For indoor/outdoor use where protection against dirt, water and moisture is necessary.
- Typical applications include:
 - Oil drilling rigs
 - Marine loading terminals
 - Processing plants
 - Pipeline pumping stations
 - Water treatment plants
 - Lubrication pits

Features

- Choice of mountings: end brackets, swivel brackets and straight brackets.
- Thick 1/8" clear acrylic lens protects against possible broken glass from lamps.
- RigMaster fixtures are supplied with the following ballast:
 - Class P low energy (E) ballasts which are equipped with an automatic thermally-activated protective device; offers protection against excessive voltage, internal ballast short circuiting, inadequate lamp maintenance and improper fixture application.
 - 220- and 240-volt options are available in both 50 and 60 Hz.
- High-temperature nickel-cadmium battery has a life expectancy of 7 to 10 years.
- Battery charger indicator light and test switch are mounted inside the enclosure and visible through the clear lens.
- Heavy-duty telescoping lampholders.
- Fixtures are shipped complete with lamps.
- Swivel End Mount fixture comes standard with eyebolt on fixture end for connecting safety cable.
- Swivel Center Mount and Straight Center Mount fixtures come standard with cast mounts on fixture end for connecting safety cable.
- Fixture is equipped with 2 NPT conduit entries; one on each end.

Standard Materials

- Reflector housings: extruded aluminum
- Door frame: 1/8" extruded aluminum
- Door clamps: heavy-duty plated spring steel
- Lampholders: white urea plastic
- Gasket: neoprene



RM2232BUSW

Illustrated Feature



Four plated steel latches on each side of door assure integrity of fixture for areas as classified.

Options

- Individually fused ballast: suffix **-F**.
- Emergency battery pack: suffix **-EL** ①.
- Emergency Battery Pack capability in moments of power interruption. Luminaire automatically switches to emergency mode, keeping one lamp illuminated for a minimum of 90 minutes. When AC power is restored, battery automatically recharges in 24 hours. Initial light output is 600-700 lumens.

NEC Certifications and Compliances

- UL Standard: UL 1598, UL 844, UL 924
- UL Listed: E10794

① Fixtures with emergency ballast are not recommended where the ambient temperature may fall below 0 °C (+32 °F) for extended periods.

② Does not apply to fixtures with fusing.

RigMaster™ Metallic Fluorescent Luminaires

For Hazardous and Adverse Locations

Suitable for Use in Wet Locations. 32 W, 40 W and 60 W Two-Lamp Fixtures.

NEC:

Class I, Division 2, Groups A, B, C, D
 NEMA Type 4X
 Marine Type Electric Fixture Non-Recessed
 Outside Type (Salt Water) ①②

Order using catalog numbering guide below or select catalog number from tables on following pages.

Catalog Numbering Guide For RigMaster Metallic Fluorescent Lighting Fixtures

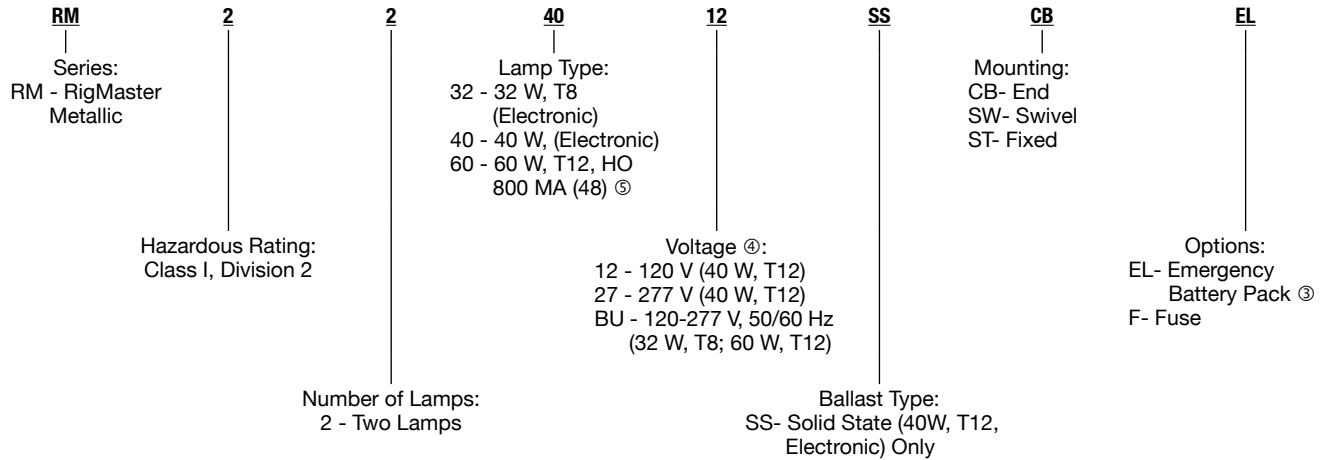

Thermal Performance RigMaster Fixtures

Fixture	Quantity	Lamp		Ambient Temp °C (°F)	"T" Numbers	Hazardous Classification
		Watt	Type			
RM2232	2	32	265MA-RS	40 °C (104 °F)	T-4	Class I, Division 2, Groups A, B, C, D
RM2240	2	40	430MA-RS	140 °C (104 °F)	T-4	Class I, Division 2, Groups A, B, C, D
RM2260	2	60	800MA-HO	40 °C (104 °F)	T-4	Class I, Division 2, Groups A, B, C, D

① Fixtures with emergency ballast are not recommended where the ambient temperature may fall below 0 °C (+32 °F) for extended periods.
 ② Does not apply to fixtures with fusing.
 ③ For 50 Hz with Emergency Battery Pack, consult factory for certification.
 ④ BU for 32 W, T8 and 60 W, T12 only. Voltage must be specified for 40 W, T12.
 ⑤ CW suffix not needed for 60 W since -28 °C (-20 °F) starting provided as a standard.

RigMaster™ Metallic Fluorescent Luminaires



For Hazardous and Adverse Locations

Suitable for Use in Wet Locations. 32 W, 40 W and 60 W Two-Lamp Fixtures.

NEC:
 Class I, Division 2, Groups A, B, C, D
 NEMA Type 4X
 Marine Type Electric Fixture Non-Recessed
 Outside Type (Salt Water) ①②

Appleton

FLUORESCENT/AREA: NEC/CEC ENCLOSED AND GASKETED

	No. of Lamps ③	Lamp Wattage	Lamp Type	Volts	Bracket Type	Catalog Number
 <p>Swivel End Bracket</p>	2	32	T8	120-277 V, 50/60 Hz	end	RM2232BUCB
	2	40	T12	120 V, 60 Hz	end	RM224012SSCB
	2	40	T12	277 V, 60 Hz	end	RM224027SSCB
	2	60	T12	120-277 V, 50/60 Hz	end	RM2260BUCB
 <p>Swivel Center Bracket</p>	2	32	T8	120-277 V, 50/60 Hz	swivel	RM2232BUSW
	2	40	T12	120 V, 60 Hz	swivel	RM224012SSSW
	2	40	T12	277 V, 60 Hz	swivel	RM224027SSSW
	2	60	T12	120-277 V, 50/60 Hz	swivel	RM2260BUSW
 <p>Straight Center Bracket</p>	2	32	T8	120-277 V, 50/60 Hz	straight	RM2232BUST
	2	40	T12	120 V, 60 Hz	straight	RM224012SSST
	2	40	T12	277 V, 60 Hz	straight	RM224027SSST
	2	60	T12	120-277 V, 50/60 Hz	straight	RM2260BUST

Replacement Parts

Description	Catalog Number
Lens	
Lens and Frame Assembly	RIGLENS
Mounting Brackets	
Straight Bracket	RM3002SEM
Angle Bracket	RM3002AEM
Swivel Bracket	RMBMSW
Back-Straight Bracket	RMBMST
Sockets	
60 W Spring Loaded	RM60SRS
60 W Fixed Replacement	RM60FRS
32 W Replacement	RM32RS

Mounting Accessories – Safety Cable

Galvanized Steel Cable	Catalog Number	Stainless Steel Cable	Catalog Number
0.9 m (2.95 ft)	RMSC3GASL	0.9 m (2.95 ft)	RMSC3STSL
1.2 m (3.94 ft)	RMSC4GASL	1.2 m (3.94 ft)	RMSC4STSL

Connecting Safety Cable

Swivel Center Mount and Straight Center Mount fixture comes standard with cast mounts on fixture end for connecting safety cable.



Swivel End Mount fixture comes standard with eyebolt on fixture end for connecting safety cable.

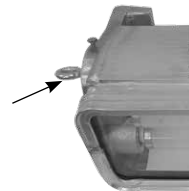

① Fixtures with emergency ballast are not recommended where the ambient temperature may fall below 0 °C (+32 °F) for extended periods.

② Does not apply to fixtures with fusing.

③ Fixtures shipped complete with lamps.

RigMaster™ Metallic Fluorescent Luminaires

For Hazardous and Adverse Locations

Suitable for Use in Wet Locations. 32 W, 40 W and 60 W Two-Lamp Fixtures.

NEC:

- Class I, Division 2, Groups A, B, C, D
- NEMA Type 4X
- Marine Type Electric Fixture Non-Recessed
- Outside Type (Salt Water) ①②

Dimensions in Millimeters (Inches)

End Bracket Mounting

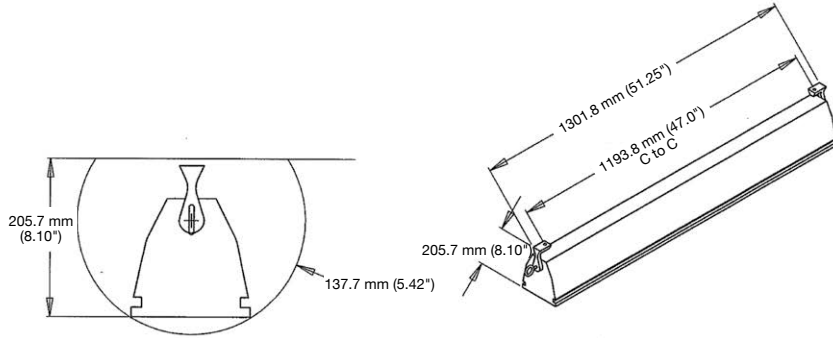

Swivel Bracket Mounting

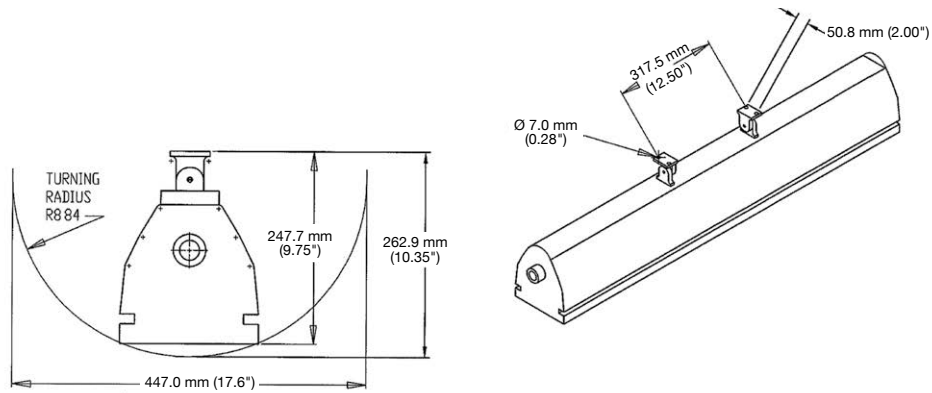

Straight Bracket Mounting

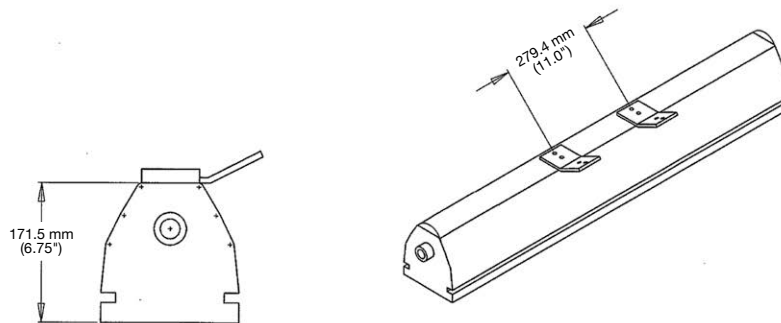

Fixture Bracket Type	Weight in kg (lb)
End	15.9 (35)
Swivel	15.9 (35)
Straight	15.9 (35)

① Fixtures with emergency ballast are not recommended where the ambient temperature may fall below 0 °C (+32 °F) for extended periods.

② Does not apply to fixtures with fusing.

RigMaster™ Metallic Fluorescent Luminaires

For Hazardous and Adverse Locations

Suitable for Use in Wet Locations. 32 W, 40 W and 60 W Two-Lamp Fixtures.

NEC:
 Class I, Division 2, Groups A, B, C, D
 NEMA Type 4X
 Marine Type Electric Fixture Non-Recessed
 Outside Type (Salt Water) ①②

Photometric Data

CANDELA DISTRIBUTION						
0.0	22.5	45.0	67.5	90.0	Flux	
0	1234	1234	1234	1234	1234	
5	1234	1228	1227	1228	1224	117
15	1183	1187	1185	1187	1183	335
25	1106	1110	1109	1110	1106	512
35	984	990	996	990	984	620
45	813	823	830	823	813	634
55	612	619	614	619	612	550
65	364	375	381	375	364	368
75	124	126	112	126	124	133
85	9	7	7	7	9	12
90	1	1	1	1		

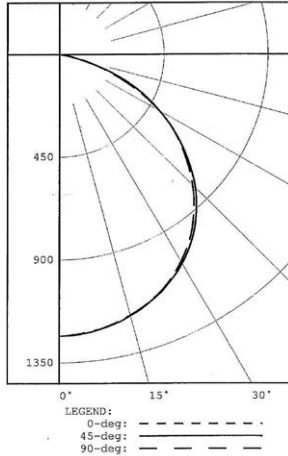

CATALOG NUMBER: RM2232BU
Luminaire: Class I, Division 2 fluorescent fixture with glass lens (4 foot, T-8, 32 Watt) tested at 120 V
Lamps: Two Phillips 32 W, 4-foot F32T8/TL741fluorescents
Ballast: Advance T-8, 32 Watt, catalog number ICN-2P32-SC 50/60 Hz, Instant Start, 120-277 V
Ambient Temperature: 24 °C (75 °F)
Mounting: With Bracket
Based on: 2,850 Lumens per Lamp
TOTAL LUMINAIRE EFFICIENCY = 57.6%
CIE Type – Direct

Plane:	0°	90°
Spacing Criteria:	1.3	1.3
Shielding Angles:	1.0	0.0

ZONAL LUMEN SUMMARY			
ZONE	LUMENS	% LAMP	% FIXT.
0- 30	964	16.9	29.4
0- 40	1584	27.8	48.3
0- 60	2767	48.6	84.3
0- 90	3281	57.6	100.0
90-180	0	0.0	0.0
0-180	3281	57.6	100.0

CANDELA DISTRIBUTION						
0.0	22.5	45.0	67.5	90.0	Flux	
0	1132	1132	1132	1132	1132	
5	1124	1128	1126	1128	1124	107
15	1085	1089	1090	1089	1085	308
25	1003	1010	1011	1010	1003	465
35	882	889	888	889	882	555
45	726	730	726	730	726	561
55	535	535	533	535	535	477
65	322	316	311	316	322	314
75	121	112	104	112	121	121
85	9	7	6	7	9	11
90	0	0	0	0	0	

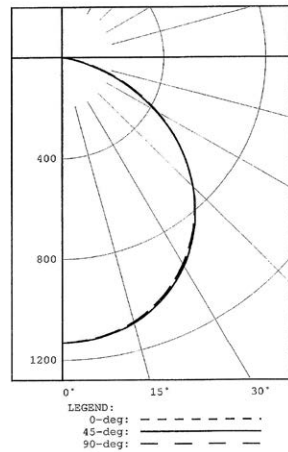

CATALOG NUMBER: RM2232BU
Luminaire: Class I, Division 2 fluorescent fixture with glass lens (4 foot, T-12, 34 Watt) tested at 120 V
Lamps: 2 Philips 34 Watt (4 foot, T-12) F40CW/RS/EW
Ballast: Advance T-12, 34 Watt, catalog number REL-2S40-SC 50/60 Hz, Instant Start, 120 V
Ambient Temperature: 24 °C (75 °F)
Mounting: With Bracket
Based on: 2,650 Lumens per Lamp
TOTAL LUMINAIRE EFFICIENCY = 55.1%
CIE Type – Direct

Plane:	0°	90°
Spacing Criteria:	1.2	1.2

ZONAL LUMEN SUMMARY			
ZONE	LUMENS	% LAMP	% FIXT.
0- 30	880	16.6	30.1
0- 40	1435	27.1	49.2
0- 60	2473	46.7	84.7
0- 90	2919	55.1	100.0
90-180	0	0.0	0.0
0-180	2919	55.1	100.0

CANDELA DISTRIBUTION						
0.0	22.5	45.0	67.5	90.0	Flux	
0	1237	1237	1237	1237	1237	
5	1227	1231	1229	1231	1227	117
15	1188	1194	1193	1194	1188	337
25	1100	1108	1111	1108	1100	511
35	968	977	976	977	968	610
45	800	806	805	806	800	619
55	591	593	594	593	591	529
65	351	352	351	352	351	347
75	122	116	106	116	122	127
85	10	8	6	8	10	12
90	0	0	0	0	0	

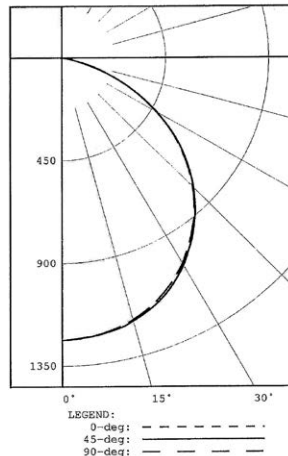

CATALOG NUMBER: RM2260BU
Luminaire: Class I, Division 2 fluorescent fixture with glass lens (4 foot, T-12, 60 Watt) tested at 120 V
Lamps: 2 Philips 60 Watt (4 foot, T-12) F48T12CWHO ALTO
Ballast: Advance T-12, 60 Watt, catalog number VEL-2S110
Ambient Temperature: 24 °C (75 °F)
Mounting: With Bracket
Based on: 4,050 Lumens per Lamp
TOTAL LUMINAIRE EFFICIENCY = 39.6%
CIE Type – Direct

Plane:	0°	90°
Spacing Criteria:	1.2	1.2

ZONAL LUMEN SUMMARY			
ZONE	LUMENS	% LAMP	% FIXT.
0- 30	965	11.9	30.1
0- 40	1574	19.4	49.1
0- 60	2722	33.6	84.8
0- 90	3208	39.6	100.0
90-180	0	0.0	0.0
0-180	3208	39.6	100.0

① Fixtures with emergency ballast are not recommended where the ambient temperature may fall below 0 °C (+32 °F) for extended periods.
 ② Does not apply to fixtures with fusing.

RigMaster™ 304 Stainless Steel Fluorescent Luminaires

Enclosed and Gasketed. For Hazardous and Adverse Locations

Suitable for use in Wet or Marine (Salt Water) Locations. 32 W, 40 W and 60 W Two-Lamp Fixtures.

CEC:

Class I, Division 2, Groups A, B, C, D
Class II, Division 1 and 2, Groups E, F, G
Class III
CSA Enclosure 3

Applications

- Appleton Rigmaster is designed for the requirements of the oil drilling industry.
- For use on seashore, offshore or land based drilling rigs.
- Suitable for industrial applications requiring a highly corrosion-resistant fluorescent fixture.
- Approved for outdoor use.
- Ideal for shipboard use. (Salt water environment).
- For use in high vibration installations.
- Can be installed to illuminate work areas, stairways and ladders, pumps and instrument panels, chemical plants and refineries or for shipboard deck lighting.

Features

- Corrosion-resistant durable seam welded 304 stainless steel construction.
- Vibration resistant – spring loaded sockets hold lamps securely with maximum shock and vibration protection.
- Positive seal lens assembly provides a secure gasketed seal around the lens. Lexan, impact resistant lens is standard.
- CG series watertight cord connectors grip the cable securely at the point of entrance to prevent insulation wear and strain on connections made within the enclosure. CG connectors seal out oil, water and other harmful atmospheres containing moisture to keep the enclosure clean and dry.
- Stainless steel snap action clips permit relamping without tools. Three clips serve as hinges allowing unobstructed access to the fixture interior.
- The highly polished finished reflector has excellent light distribution and high efficiency.
- Access to the ballast and wiring chamber is quick and easy, requiring the removal of two screws.
- Rigmasters are provided with feed-thru wiring, eliminating the need for a junction box.

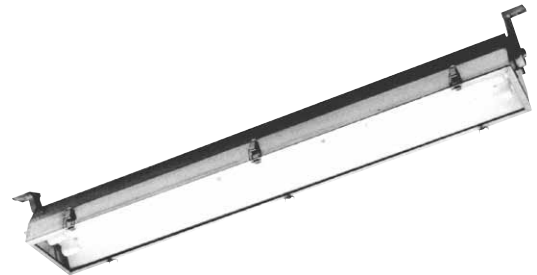

Standard Materials

- Fixture body, snap clips, hardware, lens frame: 304 stainless steel
- Mounting brackets, CG connectors, reflector: copperfree (4/10 of 1% max.) aluminum

Standard Finishes

- All components have a natural finish

Options

- Emergency battery, operates lamps at 60% for 90 minutes during power outages, suffix **-E**.
- Fabricated from 316 stainless steel, suffix **-316**.
- 60 Watt high output ballast available -29 °C (-20 °F) starting temperature).
- Lens: tempered glass, suffix **-GN**. ②

CEC Certifications and Compliances

- CSA Standard: C22.2 No. 250, C22.2 No. 137
- CSA Certified: 025428

Order using catalog numbering guide below or select catalog number from tables on following pages.

Catalog Numbering Guide For RigMaster Stainless Steel Fluorescent Lighting Fixtures – Bracket Mounted

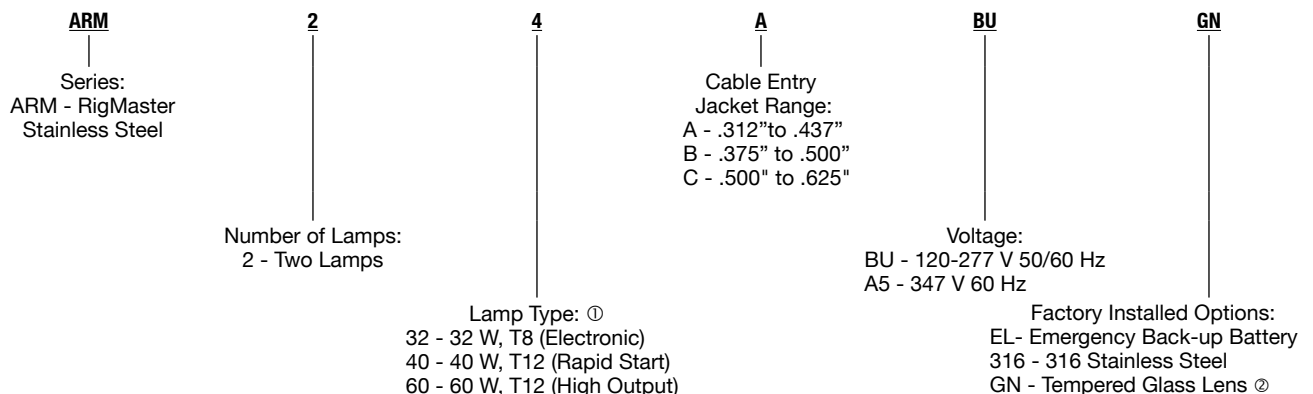

① Lamps not furnished with fixture.

② Fixture with tempered glass lens suitable only for ordinary locations.

RigMaster™ 304 Stainless Steel Fluorescent Luminaires

Enclosed and Gasketed. For Hazardous and Adverse Locations

Suitable for use in Wet or Marine (Salt Water) Locations. 32 W, 40 W and 60 W Two-Lamp Fixtures.

CEC:
 Class I, Division 2, Groups A, B, C, D
 Class II, Division 1 and 2, Groups E, F, G
 Class III
 CSA Enclosure 3

Appleton®

FLUORESCENT/AREA: NEC/CEC ENCLOSED AND GASKETED

No. of Lamps ①	Lamp Wattage	Lamp Type	Volts	Operating Amps	Input Watts	Cable Range	Catalog Number
Rapid Start — 48" — T8 — Minimum Starting Temperature -18 °C (0 °F)							
2	32	T8	120-277 V	0.49 - 0.19	59 - 55	.312-.437	ARM232ABU
2	32	T8	347 V	0.21	62	.312-.437	ARM232AA5
2	32	T8	120-277 V	0.49 - 0.19	59 - 55	.375-.500	ARM232BBU
2	32	T8	347 V	0.21	62	.375-.500	ARM232BA5
2	32	T8	120-277 V	0.49 - 0.19	59 - 55	.500-.625	ARM232CBU
2	32	T8	347 V	0.21	62	.500-.625	ARM232CA5
Rapid Start — 48" — F48T12/CW — Minimum Starting Temperature -30 °C (-22 °F)							
2	40	T12	120-277 V	0.7 - 0.26	84 - 70	.312-.437	ARM240ABU
2	40	T12	347 V	0.28	96	.312-.437	ARM240AA5
2	40	T12	120-277 V	0.7 - 0.26	84 - 70	.375-.500	ARM240BBU
2	40	T12	347 V	0.28	96	.375-.500	ARM240BA5
2	40	T12	120-277 V	0.7 - 0.26	84 - 70	.500-.625	ARM240CBU
2	40	T12	347 V	0.28	96	.500-.625	ARM240CA5
Rapid Start — 48" — 800 mA — F48T12/CW/HO — Minimum Starting Temperature -30 °C (-22 °F)							
2	60	T12	120-277 V	1.05 - 0.40	122 - 108	.312-.437	ARM260ABU
2	60	T12	347 V	0.45	144	.312-.437	ARM260AA5
2	60	T12	120-277 V	1.05 - 0.40	122 - 108	.375-.500	ARM260BBU
2	60	T12	347 V	0.45	144	.375-.500	ARM260BA5
2	60	T12	120-277 V	1.05 - 0.40	122 - 108	.500-.625	ARM260CBU
2	60	T12	347 V	0.45	144	.500-.625	ARM260CA5

Dimensions in Inches (Millimeters)

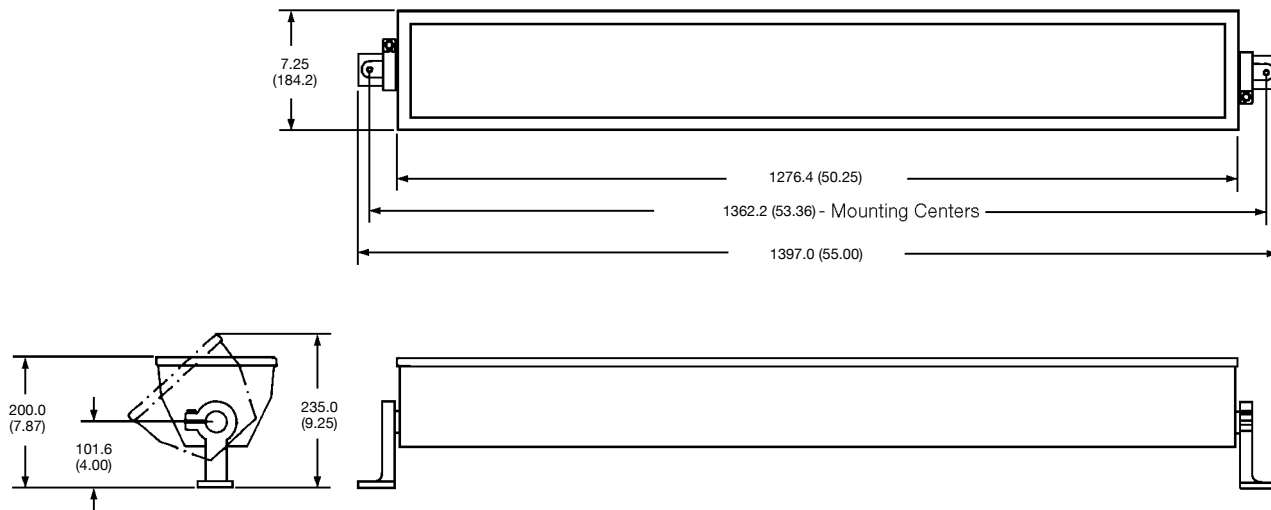

① Lamps not furnished with fixture.

Code•Master™ 2 Emergency PLT Factory Sealed Luminaires

Explosionproof, Dust-Ignitionproof

52 W, 64 W, 84 W Fluorescent. For Use with Threaded Metal Conduit.

NEC:

Class I, Division 1 and 2, Groups C, D
Class II, Division 1 and 2, Groups E, F, G
Class III
NEMA 4X
Marine Type Electric Fixtures

NEC:

Outside Type (Salt Water)
Suitable for use in Wet Locations
NFPA101, Life Safety Code

Applications

- Ideal for use in chemical and petrochemical plants, such as manufacturers of plastics, paints and thinners; in refineries; and in other process areas where ignitable vapors, dust, moisture and corrosive elements may be present.
- Suitable for use in wet locations.

Features

- Auxiliary (emergency) lighting should be used to provide a lighted means of egress for personnel in walkways, catwalks, stairs, doorways, tunnels, ramps and aisles.
- Auxiliary (emergency) lighting should be used to provide “instant on” illumination during power failures.
- Arrangement of heat-producing components results in more efficient heat dissipation for cooler fixture operation.
- Safe, easy servicing without disconnecting any wiring. Patented “wireless” design means the threading of the fixture unit onto mounting hood makes electrical connection. This allows for the fixture unit to easily thread off mounting hood for convenient servicing or for immediate replacement with a “stand-by” unit. Only wiring required is attaching two wires to connection block in mounting hood.
- Connection block is easily wired: (a) loosen two screws; (b) make wire connections; and (c) reposition connection block.
- Acme double-lead threads speed installation and fixture removal from mounting hood – only half as many turns are required as for single-lead threads. The threads do not stick or gall, eliminating the troublesome problems often encountered with single-lead threads during fixture unit removal.
- All threaded joints are flame-tight.
- Factory sealed. External seals not required.
- Fluorescent light source reduces energy costs.
- Fluorescent lamp life of 10,000 hours reduces relamping costs compared to incandescent.
- Strategic location of lamp sockets in combination with the interior prism design of the glass globe provides optimum light distribution and control.
- Superior corrosion resistance with epoxy powder coat finish.
- Choice of mountings: pendant, ceiling, bracket and stanchion.
- Fiberglass-reinforced polyester reflectors in standard dome, deep dome or 30° angle are ideal in installations where luminaire is subject to exceptionally severe corrosive atmospheres. The high bay aluminum reflector is designed for installations where mounting height work planes range from 6 to 9 m (20 to 30 ft).
- Optional guards protect globes from damage. Guards secure to fixture with three screws.
- Fixture (52, 64 or 84 W) is available for semi-continuous operation (one AC ballast permits two-lamp illumination when power is on and one battery pack permits one-lamp illumination when AC power is interrupted).
- Minimum operating temperature: 0 °C (32 °F).
- Maximum operating temperature: 40 °C (104 °F).

Battery Pack Information

- Long life, high temperature, nickel-cadmium (Ni-Cad) battery.
- Dual voltage (120/277 V, 60 Hz) solid state charger on open circuit board.
- Five-year life expectancy.
- Wiring instructions for “Push-To-Test” button are supplied with fixture.



Illustrated Features

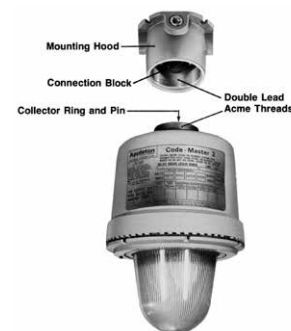

- Remote “Push-To-Test” switch is available to verify emergency operation (order separately, see F3-82).
- Red indicator light is provided with each battery pack to indicate when the battery is charging.

Standard Materials

- Ballast bodies, guards and pendant mounting hoods: copperfree (4/10 of 1% max.) aluminum
- Ceiling, bracket and stanchion mounting hoods: sand-cast copperfree (4/10 of 1% max.) aluminum
- Reflectors: aluminum or fiberglass reinforced polyester

Standard Finishes

- Ballast bodies, guards and mounting hoods: epoxy powder coat finish, electrostatically applied for complete, uniform corrosion protection

Options

- Fuse kit CF2 for field installation.

NEC Certifications and Compliances

- UL Standard: UL 924, UL 844, UL 1598
- UL Listed: E165014

Code•Master™ 2 Emergency PLT Factory Sealed Luminaires

Explosionproof, Dust-Ignitionproof

52 W, 64 W, 84 W Fluorescent. For Use with Threaded Metal Conduit.

NEC:
 Class I, Division 1 and 2, Groups C, D
 Class II, Division 1 and 2, Groups E, F, G
 Class III
 NEMA 4X
 Marine Type Electric Fixtures

NEC:
 Outside Type (Salt Water)
 Suitable for use in Wet Locations
 NFPA101, Life Safety Code

Classified Area Suitability of Code•Master 2 Emergency Series (Suitability includes use of reflector)

Lamp Type	Lamps Watts	Ambient Temp °C (°F)	Class I, Division 1 and 2 With Globe or with Globe and Reflector UL/NEC Temp. Ident. No.		Class II, Division 1 and 2 With Globe or with Globe and Reflector UL/NEC Temp. Ident. No.	
			Nameplate Marking	Groups	Nameplate Marking	Groups
PLT	52	40 (104)	T6	C, D	T4	E, F, G
	64	40 (104)	T6	C, D	T4	E, F, G
	84	40 (104)	T6	C, D	T4	E, F, G

“T” Numbers Represent the Maximum Surface Temperature for Class I, Division 1 Locations and Maximum Surface Temperature Under Dust Blanket for Class II, Division 1 Locations.

“T” Number	T1	350	325	T2	T2A	T2B	T2C	T2D	T3	T3A	T3B	T3C	T4	T4A	T5	T6
Temp. Range (°C)	351-450	326-350	301-325	281-300	261-280	231-260	216-230	201-215	181-200	166-180	161-165	136-160	121-135	101-120	86-100	85
Temp. Range (°F)	664-842	619-662	574-617	538-572	502-536	448-500	421-446	394-419	358-392	331-356	322-329	277-320	250-275	214-248	187-212	185

Fixture and Accessory Weights in kg (lb)

Fixture Size	Fixture Weight	Reflector Weight	Guard Weight
52 W	20.4 (44.97)	1.4 (3.09)	0.9 (1.98)
64 W	20.4 (44.97)	1.4 (3.09)	0.9 (1.98)
84 W	20.4 (44.97)	1.4 (3.09)	0.9 (1.98)

Mounting Hood Weights kg (lb)

Pendant	Ceiling	Bracket	Stanchion
0.9 (1.98)	1.8 (3.97)	2.7 (5.95)	0.9 (1.98)

Electrical Specification for AC Operation

Fixture Wattage	Line Voltage (V)	Frequency (Hz)	Type of Ballast	Line Amps (A)	Maximum Wattage (W/W)	Catalog Number ①
52	120	60	PLT Electronic	0.49	52	CMBFS5212
52	277	60	PLT Electronic	0.20	52	CMBFS5227
64	120	60	PLT Electronic	0.57	64	CMBFS6412
64	277	60	PLT Electronic	0.24	64	CMBFS6427
84	120	60	PLT Electronic	0.73	84	CMBFS8412
84	277	60	PLT Electronic	0.31	84	CMBFS8427

① For optional fusing, order kit -CF2.

Code•Master™ 2 Emergency PLT Factory Sealed Luminaires

Explosionproof, Dust-Ignitionproof





52 W, 64 W, 84 W Fluorescent. For Use with Threaded Metal Conduit.

NEC:

Class I, Division 1 and 2, Groups C, D
 Class II, Division 1 and 2, Groups E, F, G
 Class III
 NEMA 4X
 Marine Type Electric Fixtures

NEC:

Outside Type (Salt Water)
 Suitable for use in Wet Locations
 NFPA101, Life Safety Code

	Lamp Watts	Lamp Type	Hub Size (Inches)	Catalog Number ②③	
Pendant					
	52	PLT	3/4	CFPS5275	
			1	CFPS5210	
	64	PLT	3/4	CFPS6475	
			1	CFPS6410	
	84	PLT	3/4	CFPS8475	
			1	CFPS8410	
Ceiling					
	52	PLT	3/4	CFCS5275	
			1	CFCS5210	
	64	PLT	3/4	CFCS6475	
			1	CFCS6410	
	84	PLT	3/4	CFCS8475	
			1	CFCS8410	
Bracket					
	52	PLT	3/4	CFBS5275	
			1	CFBS5210	
	64	PLT	3/4	CFBS6475	
			1	CFBS6410	
	84	PLT	3/4	CFBS8475	
			1	CFBS8410	
25° Stanchion					
	52	PLT	1-1/4 or 1-1/2 ①	CFSS52150	
			1-1/4 or 1-1/2 ①	CFSS64150	
	64	PLT	1-1/4 or 1-1/2 ①	CFSS64150	
			1-1/4 or 1-1/2 ①	CFSS84150	
	84	PLT	1-1/4 or 1-1/2 ①	CFSS84150	
			1-1/4 or 1-1/2 ①	CFSS84150	
Fixture Units					
Ballast body with globe. Indicate voltage desired by adding voltage suffix to Fixture Unit catalog number listed below.					
	Lamp Watts	Lamp Type	Unit Catalog Number	Add Voltage Suffixes	
				120 V	277 V
	52	PLT	CMBFS52	12	27
	64	PLT	CMBFS64	12	27
	84	PLT	CMBFS84	12	27

- ① 1-1/2" tapped hub furnished with 1-1/2" to 1-1/4" reducer.
- ② To order fixture with guard, add suffix -G before adding voltage suffix.
- ③ Add voltage suffix -12L for 120 V with lamp; or -27L for 277 V with lamp.

Code•Master™ 2 Emergency PLT Factory Sealed Luminaires





Explosionproof, Dust-Ignitionproof

52 W, 64 W, 84 W Fluorescent. For Use with Threaded Metal Conduit.

NEC:
 Class I, Division 1 and 2, Groups C, D
 Class II, Division 1 and 2, Groups E, F, G
 Class III
 NEMA 4X
 Marine Type Electric Fixtures

NEC:
 Outside Type (Salt Water)
 Suitable for use in Wet Locations
 NFPA101, Life Safety Code

Mounting Hoods

		Hub Size Inches	Catalog Number
Pendant		One Hub	
Ceiling		Four hubs, Three Close-Up Plugs	
Bracket		Four hubs, Three Close-Up Plugs	
25° Stanchion		One Hub	
		1-1/4 or 1-1/2 ①	
Mounting Adapter with Connection Block		Permits use of existing A-51 mounting hoods (AAC Ceiling or AALB Bracket) with the new Code•Master 2 Fixture Unit. After removing existing Fixture Unit and adapter, screw in the new CMAD-1 Adapter. Then thread the new Fixture Unit into the CMAD-1.	

① 1-1/2" tapped hub furnished with 1-1/2" to 1-1/4" reducer.

Code•Master™ 2 Emergency PLT Factory Sealed Luminaires

Explosionproof, Dust-Ignitionproof







52 W, 64 W, 84 W Fluorescent. For Use with Threaded Metal Conduit.

NEC:

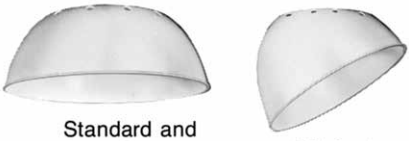
Class I, Division 1 and 2, Groups C, D
 Class II, Division 1 and 2, Groups E, F, G
 Class III
 NEMA 4X
 Marine Type Electric Fixtures

NEC:

Outside Type (Salt Water)
 Suitable for use in Wet Locations
 NFPA101, Life Safety Code

	Description	Catalog Number
Polyester Reflectors		
 <p>Standard and Deep Dome</p>	Standard Dome	CMR-4ST
	Deep Dome	CMR-4DD
	30° Angle	CMR-4AN
Aluminum High Bay Reflectors		
		CMR-4HB
Prismatic Glass Globes		
	52, 64, 84 W PLT	CGL-400
Aluminum Guards		
	52, 64, 84 W PLT	CGU4
Connection Block – For Code•Master 2 PLT Fixtures		
	52 W - 84 W	PLT32RS
	52 W - 84 W	VPT-7

Appleton®

FLUORESCENT/AREA: NEC/CEC EXPLOSIONPROOF

Code•Master™ 2 Emergency PLT Factory Sealed Luminaires

Explosionproof, Dust-Ignitionproof

52 W, 64 W, 84 W Fluorescent. For Use with Threaded Metal Conduit.

NEC:
 Class I, Division 1 and 2, Groups C, D
 Class II, Division 1 and 2, Groups E, F, G
 Class III
 NEMA 4X
 Marine Type Electric Fixtures

NEC:
 Outside Type (Salt Water)
 Suitable for use in Wet Locations
 NFPA101, Life Safety Code

Dimensions in Millimeters (Inches)

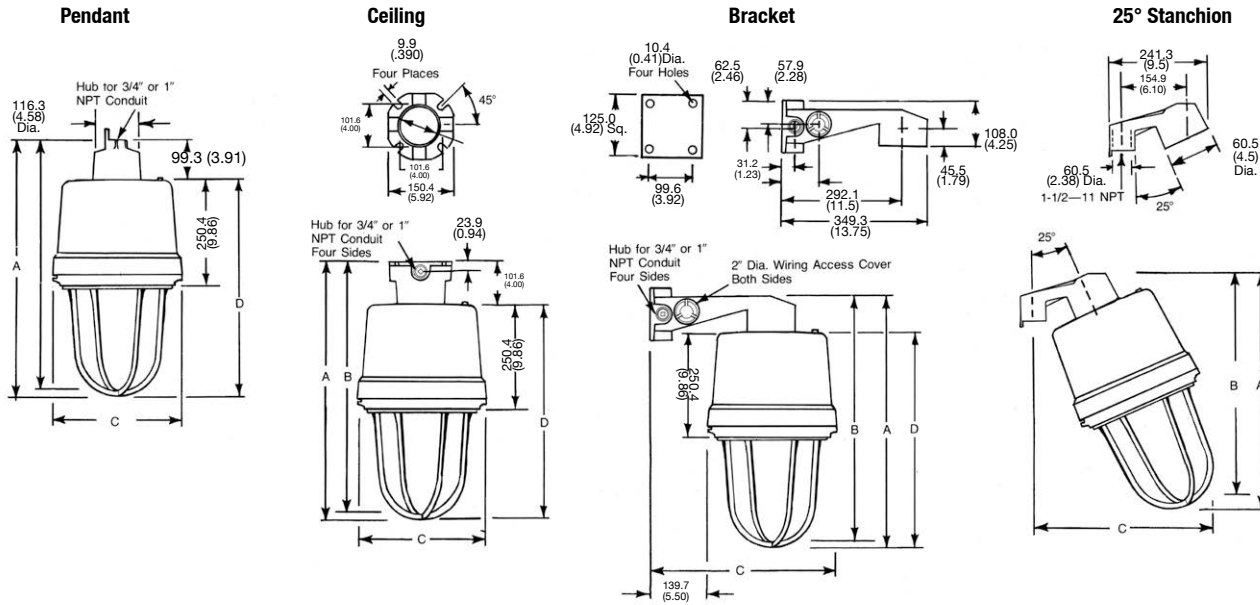

	Pendant				Ceiling				Bracket			25° Stanchion			
	A	B	C	D	A	B	C	D	A	B	C	D	A	B	C
52-84 W	622.3 (24.50)	596.9 (23.50)	304.8 (12.00)	517.1 (20.36)	618.7 (24.36)	593.3 (23.36)	304.8 (12.00)	517.1 (20.36)	625.1 (24.61)	599.7 (23.61)	444.5 (17.50)	517.1 (20.36)	563.9 (22.20)	538.5 (21.20)	444.5 (17.50)

Reflector Dimensions in Millimeters (Inches)

Type Reflector	A	B	C	Standard and Deep Dome	30° Angle	High Bay
Standard Dome	284.5 (11.20)	149.9 (5.90)	475.0 (18.70)			
Deep Dome	268.2 (10.56)	177.8/ (7.00)	515.6 (20.30)			

Appleton

FLUORESCENT/AREA: NEC/CEC EXPLOSIONPROOF

Code•Master™ 2 Emergency PLT Factory Sealed Luminaires

Explosionproof, Dust-Ignitionproof

* Photometric data is based on a fixture with two 32 W Compact Fluorescent PL-T lamps (2,400 lumens each). For candlepower values of fixtures with two 26 W PL-T lamps (1,800 lumens each), multiply by 0.75. For Candlepower values of fixtures with two 42 W PL-T Lamps, (3,200 lumens each) multiply by 1.34.

NEC:

Class I, Division 1 and 2, Groups C, D
 Class II, Division 1 and 2, Groups E, F, G
 Class III
 NEMA 4X
 Marine Type Electric Fixtures

NEC:

Outside Type (Salt Water)
 Suitable for use in Wet Locations
 NFPA101, Life Safety Code

Photometric Data

Total Luminaire Efficiency = 79.8%

CIE Type – Semi-Direct

Plane	Spacing Criteria
0-180	2.88
90-270	2.88
Diagonal	2.82

Zone	Lumens
0-10	17.70
10-20	61.05
20-30	132.44
30-40	236.78
40-50	336.66
50-60	421.68
60-70	485.34
70-80	517.29
80-90	513.72
90-100	468.70
100-110	352.77
110-120	200.85
120-130	73.54
130-140	11.28
140-150	1.12
150-160	0.31
160-170	0.06
170-180	0.00

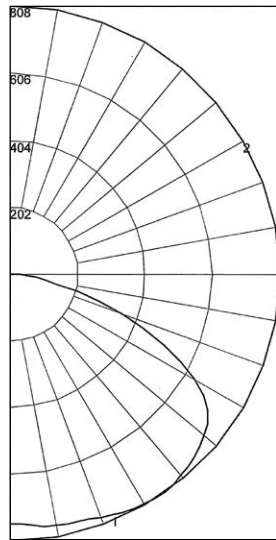

Maximum Candela = 493
 Located at Horizontal Angle = 0, Vertical Angle = 70
 #1 – Vertical Plane through Horizontal Angles (0-180)
 (Through Max. Cd.)
 #2 – Horizontal Cone through Vertical Angle (70)
 (Through Max. Cd.)

REPORT NUMBER: **CMBF64G**

64 W (two 32 W lamps) Fluorescent Fixture with Globe only *

Coefficients of Utilization – Zonal Cavity Method

Effective Floor Cavity Reflectance 0.20

% Ceiling Rcc	% Walls Rw	80		70		50		30		10		0							
		70	50	30	10	70	50	30	10	50	30	10	50	30	10	0			
0	0	90	90	90	90	85	85	85	85	76	76	76	68	68	68	60	60	60	57
1	1	76	70	65	60	71	66	61	57	58	54	51	51	48	45	45	42	40	36
2	2	67	58	51	45	63	55	48	42	48	43	38	42	37	34	36	32	29	26
3	3	60	49	41	35	56	46	39	33	40	34	29	35	30	26	30	26	23	20
4	4	54	43	34	28	50	40	32	26	35	28	23	30	25	21	26	21	18	15
5	5	49	37	29	23	46	35	27	22	31	24	19	26	21	17	23	18	15	12
6	6	45	33	25	19	42	31	23	18	27	21	16	23	18	14	20	16	12	10
7	7	41	29	22	16	38	28	20	15	24	18	14	21	16	12	18	14	10	8
8	8	38	26	19	14	36	25	18	13	22	16	12	19	14	10	16	12	9	7
9	9	35	24	17	12	33	23	16	11	20	14	10	17	12	9	15	11	8	9
10	10	33	22	15	11	31	21	14	10	18	13	9	16	11	8	14	10	7	5

Zonal Lumen Summary

Zone	Lumens	% Lamp	% Fixture	Zone	Lumens	% Lamp	% Fixture
0-30	211.19	4.4	5.5	90-120	1022.32	21.3	26.7
0-40	447.97	9.3	11.7	90-130	1095.85	22.8	28.6
0-60	1206.31	25.1	31.5	90-150	1108.26	23.1	28.6
0-90	2722.64	56.7	71.1	90-180	1108.63	23.1	28.9
				0-180	3831.28	79.8	100.0

Total Luminaire Efficiency = 66.5%

CIE Type – Direct

Plane	Spacing Criteria
0-180	1.62
90-270	1.62
Diagonal	1.74

Zone	Lumens
0-10	73.25
10-20	220.57
20-30	368.60
30-40	505.61
40-50	603.19
50-60	638.42
60-70	497.24
70-80	226.17
80-90	57.98
90-100	1.64
100-110	0.00
110-120	0.00
120-130	0.00
130-140	0.00
140-150	0.00
150-160	0.00
160-170	0.00
170-180	0.00

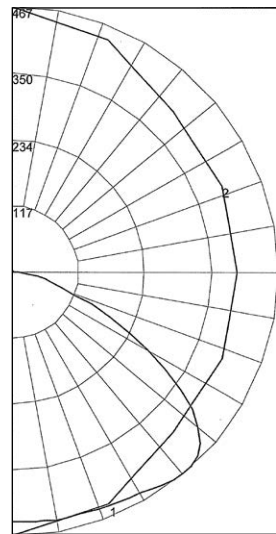

Maximum Candela = 808
 Located at Horizontal Angle = 0, Vertical Angle = 35
 #1 – Vertical Plane through Horizontal Angles (0-180)
 (Through Max. Cd.)
 #2 – Horizontal Cone through Vertical Angle (35)
 (Through Max. Cd.)

REPORT NUMBER: **CMBF64ST**

64 W (two 32 W lamps) Fluorescent Fixture with Globe and Standard Dome Reflector *

Coefficients of Utilization – Zonal Cavity Method

Effective Floor Cavity Reflectance 0.20

% Ceiling Rcc	% Walls Rw	80		70		50		30		10		0							
		70	50	30	10	70	50	30	10	50	30	10	50	30	10	0			
0	0	79	79	79	79	77	77	77	77	74	74	74	71	71	71	68	68	68	66
1	1	72	69	66	63	70	67	64	62	64	62	60	62	60	58	59	58	56	55
2	2	65	59	54	50	63	58	53	49	55	52	48	53	50	47	51	48	46	45
3	3	59	51	45	41	57	50	45	40	48	43	40	46	42	39	44	41	38	37
4	4	53	45	38	34	52	44	38	33	42	37	33	40	36	32	39	35	32	30
5	5	49	39	33	28	47	39	33	28	37	32	28	36	31	28	35	31	27	26
6	6	45	35	29	24	43	34	29	24	33	28	24	32	27	24	31	27	23	22
7	7	41	32	25	21	40	31	25	21	30	25	21	29	24	21	28	24	20	19
8	8	38	29	23	19	37	28	22	18	27	22	18	26	22	18	26	21	18	17
9	9	35	26	20	16	34	26	20	16	25	20	16	24	19	16	23	19	16	15
10	10	33	24	18	15	32	24	18	15	23	18	15	22	18	15	22	17	14	13

Zonal Lumen Summary

Zone	Lumens	% Lamp	% Fixture	Zone	Lumens	% Lamp	% Fixture
0-30	662.42	13.8	20.7	90-120	1.64	0.0	0.1
0-40	1168.03	24.3	36.6	90-130	1.64	0.0	0.1
0-60	2409.64	50.2	75.5	90-150	1.64	0.0	0.1
0-90	3191.04	66.5	99.9	90-180	1.64	0.0	0.1
				0-180	3192.68	66.5	100.0

Code•Master™ 2 Emergency PLT Factory Sealed Luminaires

Explosionproof, Dust-Ignitionproof

* Photometric data is based on a fixture with two 32 W Compact Fluorescent PL-T lamps (2,400 lumens each). For candlepower values of fixtures with two 26 W PL-T lamps (1,800 lumens each), multiply by 0.75. For Candlepower values of fixtures with two 42 W PL-T Lamps. (3,200 lumens each) multiply by 1.34.

NEC:
 Class I, Division 1 and 2, Groups C, D
 Class II, Division 1 and 2, Groups E, F, G
 Class III
 NEMA 4X
 Marine Type Electric Fixtures

NEC:
 Outside Type (Salt Water)
 Suitable for use in Wet Locations
 NFPA101, Life Safety Code

Photometric Data

Total Luminaire Efficiency = 57.4%

CIE Type – Direct

Plane	Spacing Criteria
0-180	1.52
90-270	1.70
Diagonal	1.62

Zone	Lumens
0-10	62.13
10-20	187.93
20-30	317.49
30-40	428.14
40-50	471.22
50-60	454.23
60-70	384.77
70-80	276.31
80-90	157.68
90-100	13.45
100-110	0.00
110-120	0.00
120-130	0.00
130-140	0.00
140-150	0.00
150-160	0.00
160-170	0.00
170-180	0.00

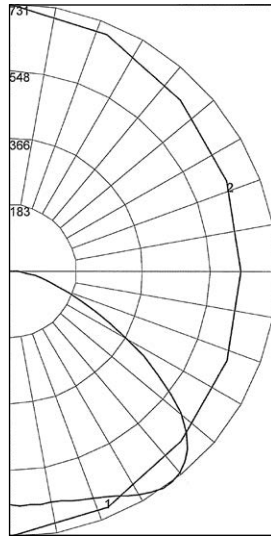

Maximum Candela = 731
 Located at Horizontal Angle = 90, Vertical Angle = 37.5
 #1 – Vertical Plane through Horizontal Angles (90–270)
 (Through Max. Cd.)
 #2 – Horizontal Cone through Vertical Angle (37.5)
 (Through Max. Cd.)

REPORT NUMBER: **CMBF64AN**

64 W (two 32 W lamps) Fluorescent Fixture with Globe and 30° Angle Dome Reflector *

Coefficients of Utilization – Zonal Cavity Method

Effective Floor Cavity Reflectance 0.20

% Ceiling	Rcc	80				70				50				30				10				0
		70	50	30	10	70	50	30	10	50	30	10	50	30	10	50	30	10				
% Walls	Rw																					
0	68	68	68	68	67	67	67	67	64	64	64	61	61	61	58	58	58	57	57			
1	61	58	55	52	59	56	54	51	54	51	49	51	49	48	49	48	46	45	45			
2	55	49	45	41	53	48	44	40	46	43	39	44	41	39	42	40	38	36	36			
3	50	43	37	33	48	42	37	33	40	36	32	38	35	32	37	34	31	30	30			
4	45	37	32	28	44	37	31	27	35	31	27	34	30	27	32	29	26	25	25			
5	41	33	28	23	40	32	27	23	31	27	23	30	26	23	29	25	22	21	21			
6	38	30	24	20	37	29	24	20	28	23	20	27	23	20	26	22	19	18	18			
7	35	27	21	18	34	26	21	18	25	21	17	24	20	17	24	20	17	16	16			
8	32	24	19	16	32	24	19	15	23	19	15	22	18	15	22	18	15	14	14			
9	30	22	17	14	29	22	17	14	21	17	14	20	16	14	20	16	13	12	12			
10	28	20	16	12	28	20	15	12	19	15	12	19	15	12	18	15	12	11	11			

Zonal Lumen Summary

Zone	Lumens	% Lamp	% Fixture	Zone	Lumens	% Lamp	% Fixture
0-30	567.55	11.8	20.6	90-120	13.45	0.3	0.5
0-40	995.69	20.7	36.2	90-130	13.45	0.3	0.5
0-60	1921.14	40.0	69.8	90-150	13.45	0.3	0.5
0-90	2739.90	57.1	99.5	90-180	13.45	0.3	0.5
				0-180	2753.35	57.4	100.0

Total Luminaire Efficiency = 67.2%

CIE Type – Direct

Plane	Spacing Criteria
0-180	1.44
90-270	1.44
Diagonal	1.60

Zone	Lumens
0-10	88.95
10-20	260.61
20-30	413.34
30-40	539.82
40-50	630.36
50-60	641.74
60-70	436.60
70-80	164.84
80-90	47.37
90-100	1.92
100-110	0.00
110-120	0.00
120-130	0.00
130-140	0.00
140-150	0.00
150-160	0.00
160-170	0.00
170-180	0.00

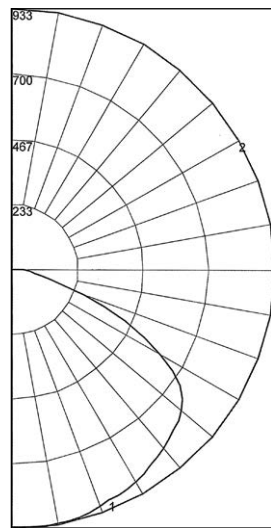

Maximum Candela = 933
 Located at Horizontal Angle = 0, Vertical Angle = 7.5
 #1 – Vertical Plane through Horizontal Angles (0–180)
 (Through Max. Cd.)
 #2 – Horizontal Cone through Vertical Angle (7.5)
 (Through Max. Cd.)

REPORT NUMBER: **CMBF64DD**

64 W (two 32 W lamps) Fluorescent Fixture with Globe and Deep Dome Reflector *

Coefficients of Utilization – Zonal Cavity Method

Effective Floor Cavity Reflectance 0.20

% Ceiling	Rcc	80				70				50				30				10				0
		70	50	30	10	70	50	30	10	50	30	10	50	30	10	50	30	10				
% Walls	Rw																					
0	80	80	80	80	78	78	78	78	75	75	75	71	71	71	69	69	69	67	67			
1	73	70	67	65	71	68	66	63	66	63	61	63	61	60	60	59	58	56	56			
2	66	61	56	52	65	59	55	52	57	53	50	55	52	49	53	50	48	47	47			
3	60	53	47	43	59	52	47	43	50	45	42	48	44	41	46	43	40	39	39			
4	55	47	41	36	53	46	40	36	44	39	35	42	38	35	41	37	34	33	33			
5	50	41	35	31	49	41	35	30	39	34	30	38	33	30	37	33	29	28	28			
6	46	37	31	26	45	36	30	26	35	30	26	34	29	26	33	29	25	24	24			
7	43	33	27	23	41	33	27	23	32	27	23	31	26	23	30	26	22	21	21			
8	40	30	24	20	38	30	24	20	29	24	20	28	23	20	27	23	20	19	19			
9	37	28	22	18	36	27	22	18	26	21	18	26	21	18	25	21	18	16	16			
10	34	25	20	16	34	25	20	16	24	19	16	24	19	16	23	19	16	15	15			

Zonal Lumen Summary

Zone	Lumens	% Lamp	% Fixture	Zone	Lumens	% Lamp	% Fixture
0-30	762.91	15.9	23.7	90-120	1.92	0.0	0.1
0-40	1302.73	27.1	40.4	90-130	1.92	0.0	0.1
0-60	2574.82	53.6	79.8	90-150	1.92	0.0	0.1
0-90	3223.63	67.2	99.9	90-180	1.92	0.0	0.1
				0-180	3225.55	57.4	100.0

Code•Master™ 2 Emergency PLT Factory Sealed Luminaires

Explosionproof, Dust-Ignitionproof

* Photometric data is based on a fixture with two 32 W Compact Fluorescent PL-T lamps (2,400 lumens each). For candlepower values of fixtures with two 26 W PL-T lamps (1,800 lumens each), multiply by 0.75. For Candlepower values of fixtures with two 42 W PL-T Lamps, (3,200 lumens each) multiply by 1.34.

NEC:
 Class I, Division 1 and 2, Groups C, D
 Class II, Division 1 and 2, Groups E, F, G
 Class III
 NEMA 4X
 Marine Type Electric Fixtures

NEC:
 Outside Type (Salt Water)
 Suitable for use in Wet Locations
 NFPA101, Life Safety Code

Photometric Data

Total Luminaire Efficiency = 58.9%

CIE Type – Direct

Plane	Spacing Criteria
0-180	0.82
90-270	0.82
Diagonal	0.92

Zone	Lumens
0-10	239.15
10-20	599.67
20-30	645.20
30-40	625.54
40-50	452.95
50-60	185.71
60-70	58.40
70-80	15.26
80-90	4.25
90-100	0.69
100-110	0.00
110-120	0.00
120-130	0.00
130-140	0.00
140-150	0.00
150-160	0.00
160-170	0.00
170-180	0.00

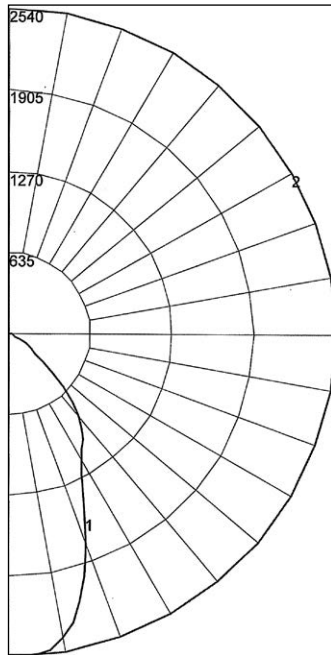

Maximum Candela = 2540
 Located at Horizontal Angle = 0, Vertical Angle = 5
 #1 – Vertical Plane through Horizontal Angles (0–180)
 (Through Max. Cd.)
 #2 – Horizontal Cone through Vertical Angle (5)
 (Through Max. Cd.)

REPORT NUMBER: **CMBF64HB**

64 W (two 32 W lamps) Fluorescent Fixture with Globe and High Bay Reflector *

Coefficients of Utilization – Zonal Cavity Method

Effective Floor Cavity Reflectance 0.20

% Ceiling Rcc	80	70				50				30				10				0
		70	50	30	10	70	50	30	10	50	30	10	50	30	10	50	30	
0	70	70	70	70	68	68	68	68	65	65	65	63	63	63	60	60	60	59
1	66	64	63	61	65	63	62	60	61	59	58	58	57	57	56	56	55	54
2	62	59	56	54	61	58	55	53	56	54	52	54	52	51	52	51	50	49
3	58	54	51	48	57	53	50	47	51	49	47	50	48	46	49	47	45	44
4	55	50	46	43	54	49	45	43	48	44	42	46	44	42	45	43	41	40
5	51	46	42	39	50	45	41	39	44	41	38	43	40	38	42	39	37	36
6	48	42	38	35	47	42	38	35	41	37	35	40	37	35	39	36	34	33
7	46	39	35	32	45	39	35	32	38	35	32	37	34	32	37	34	32	31
8	43	37	33	30	42	36	32	30	36	32	30	35	32	29	34	31	29	28
9	41	34	30	28	40	34	30	28	33	30	27	33	30	27	32	29	27	26
10	38	32	28	26	38	32	28	26	31	28	26	31	28	25	30	27	25	25

Zonal Lumen Summary

Zone	Lumens	% Lamp	% Fixture	Zone	Lumens	% Lamp	% Fixture
0-30	1484.03	30.9	52.5	90-120	0.69	0.0	0.0
0-40	2109.57	43.9	74.6	90-130	0.69	0.0	0.0
0-60	2748.23	57.3	97.2	90-150	0.69	0.0	0.0
0-90	2826.12	58.9	100.0	90-180	0.69	0.0	0.0
				0-180	2628.80	58.9	100.0

Appleton

FLUORESCENT/AREA: NEC/CEC EXPLOSIONPROOF

Code•Master™ PLT Factory Sealed Luminaires

Explosionproof, Dust-Ignitionproof

Integrally Ballasted. 26 W, 32 W, 42 W, 52 W, 64 W, 84 W Compact Fluorescent. For use with Threaded Metal Conduit.

NEC:

Class I, Division 1 and 2, Groups B♦, C, D
Class II, Division 1 and 2, Groups E, F, G
Class III
NEMA 4X
Suitable for use in wet locations

CEC:

Class I, Division 1 and 2, Groups B, C, D
Class II, Division 1 and 2, Groups E, F, G
Class III
CSA 4X

Applications

- For use in hazardous locations such as plants where plastics, paints, thinners and petrochemicals are manufactured, and in other areas where ignitable vapors, dust, moisture and corrosive elements may be present.
- For use in areas where an instant-on white light is desired.
- Suitable for use in wet locations.
- Standard fixtures designed for 26 W, 32 W, 42 W, 52 W (two 26 W), 64 W (two 32 W), and 84 W (two 42 W) PLT lamps.
- Cold weather starting to a minimum temperature of -18 °C (0 °F) for the Code•Master Jr. PLT and -30 °C (-22 °F) for the Code•Master 2 PLT.

Features

- Fixtures operate safely in high ambient temperatures.
- Arrangement of heat-producing components results in efficient heat dissipation for cooler fixture operation.
- Patented “wireless” design. Threading of fixture unit onto mounting hood makes electrical connection. The only wiring required is attaching two wires to connection block in mounting hood.
- Connection block is easily wired: (a) loosen two screws; (b) make wire connections; and (c) reposition connection block.
- Safe, easy servicing without disconnecting any wiring. “Wireless” fixture unit threads off mounting hood for convenient servicing or for immediate replacement with a “stand-by” unit.
- Acme double-lead threads speed installation and fixture removal from mounting hood – only half as many turns are required as for single-lead threads. The threads do not stick, or gall, eliminating problems often encountered with single-lead threads during fixture unit removal.
- All threaded joints are flame-tight.
- Factory sealed. External seals not required for Groups C and D.
- Fixtures for use in Group B locations are furnished complete with UL required sealing fitting for Code•Master Jr. PLT only.
- Heat- and impact-resistant globes have smooth dust-resistant exterior.
- Superior corrosion resistance, with epoxy powder coat finish.
- Fluorescent light source reduces energy cost.
- Strategic location of lamp socket, in combination with interior prism design of the glass globe, provides optimum light distribution and control.
- Choice of mountings – pendant, ceiling, bracket and stanchion.
- Optional guards protect globes from damage. Secured to fixture with three stainless steel screws.
- Fiberglass reinforced polyester reflectors, in standard dome or 30° angle styles, are ideal in installations where luminaire is subject to exceptionally severe corrosive atmospheres. The high bay aluminum reflector is intended for installations where mounting height work planes range from 6 to 9 m (20 to 30 ft).
- Fluorescent lamp life of 10,000 hours reduces relamping cost compared to incandescent, and provides superior T numbers.

Standard Materials

- Ballast bodies and guards: copperfree (4/10 of 1% max.) aluminum
- Pendant mounting hoods: diecast copperfree (4/10 of 1% max.) aluminum
- Ceiling, bracket and stanchion mounting hoods: sand cast copperfree (4/10 of 1% max.) aluminum
- Reflectors: fiberglass reinforced polyester (white) or aluminum



26-42W Code•Master Jr. PLT



52-84W Code•Master 2 PLT

Illustrated Features



As Fixture unit is threaded into mounting hood an automatic electrical connection is made.

Standard Finishes

- Ballast bodies, guards and mounting hoods: epoxy powder coat finish, electrostatically applied for complete, uniform corrosion protection

NEC/CEC Certifications and Compliances

- UL Standard: UL 1598, UL 844
- UL Listed: E10444
- CSA Standard: C22.2 No. 250, C22.2 No. 137
- CSA Certified: 025428

♦ Fixtures are for use with Group B atmospheres only when used with Group B mounting hoods. For 26 W, 32 W, and 42 W fixtures only.

Code•Master™ PLT Factory Sealed Luminaires

Explosionproof, Dust-Ignitionproof

Integrally Ballasted. 26 W, 32 W, 42 W, 52 W, 64 W, 84 W Compact Fluorescent. For use with Threaded Metal Conduit.

NEC:

Class I, Division 1 and 2, Groups B♦, C, D
 Class II, Division 1 and 2, Groups E, F, G
 Class III
 NEMA 4X
 Suitable for use in wet locations

CEC:

Class I, Division 1 and 2, Groups B, C, D
 Class II, Division 1 and 2, Groups E, F, G
 Class III
 CSA 4X

Catalog Numbering Guide

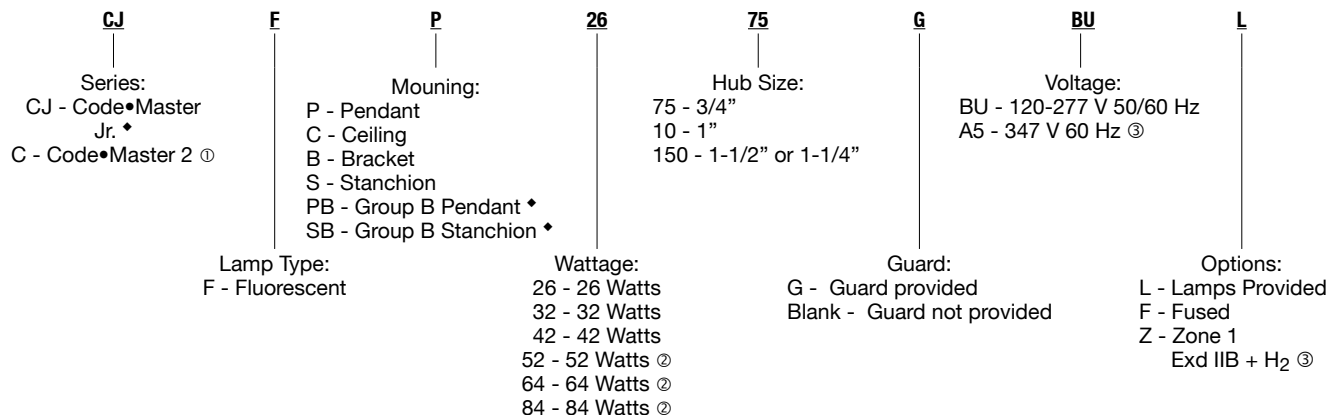

Classified Area Suitability of Code•Master™ Series PLT Fixtures — Suitability includes use of reflector

Lamp Type	Lamp Watts	Supply Wire °C (°F)	Ambient Temp °C (°F)	Class I, Division 1 and 2 with Globe or with Reflector UL/NEC Temp. Ident. No.		Class II, Division 1 and 2 with Globe or with Reflector UL/NEC Temp. Ident. No.	
				Nameplate Marking	Groups	Nameplate Marking	Groups
PLT (4-pin)	26	75 (167)	40 (104)	T6	B♦,C,D	T4A	E, F, G
PLT (4-pin)	32	75 (167)	40 (104)	T6	B♦,C,D	T4A	E, F, G
PLT (4-pin)	42	75 (167)	40 (104)	T6	B♦,C,D	T4A	E, F, G
PLT (4-pin)	52 (2 x 26)	75 (167)	40 (104)	T6	C, D	T4	E, F, G
		75 (167)	55 (131)	T5	C, D	—	—
PLT (4-pin)	64 (2 x 32)	75 (167)	40 (104)	T6	C, D	T4	E, F, G
		75 (167)	55 (131)	T5	C, D	—	—
		75 (167)	65 (149)	T5	C, D	—	—
PLT (4-pin)	84 (2 x 42)	75 (167)	40 (104)	T6	C, D	T4	E, F, G
		75 (167)	55 (131)	T5	C, D	—	—
		75 (167)	65 (149)	T5	C, D	—	—

“T” Numbers Represent the Maximum Surface Temperature for Class I, Division 1 Locations and Maximum Surface Temperature Under Dust Blanket for Class II, Division 1 Locations.

“T” Number	T1	350	325	T2	T2A	T2B	T2C	T2D	T3	T3A	T3B	T3C	T4	T4A	T5	T6
Temp. Range (°C)	351-450	326-350	301-325	281-300	261-280	231-260	216-230	201-215	181-200	166-180	161-165	136-160	121-135	101-120	86-100	85
Temp Range (°F)	664-842	619-662	574-617	538-572	502-536	448-500	421-446	394-419	358-392	331-356	322-329	277-320	250-275	214-248	187-212	185

♦ Fixtures are for use with Group B atmospheres only when used with Group B mounting hoods. For 26 W, 32 W, and 42 W fixtures only.

① Available only for 52, 64 and 84 watt fixtures.

② Available in Codemmaster 2 Only

③ Certified to meet the Canadian Electrical Code (CEC) only.

Code•Master™ PLT Factory Sealed Luminaires

Explosionproof, Dust-Ignitionproof

Integrally Ballasted. 26 W, 32 W, 42 W, 52 W, 64 W, 84 W Compact Fluorescent. For use with Threaded Metal Conduit.

NEC:
 Class I, Division 1 and 2, Groups B♦, C, D
 Class II, Division 1 and 2, Groups E, F, G
 Class III
 NEMA 4X
 Suitable for use in wet locations

	Lamp Watts	Hub Size (Inches)	Catalog Number with Globe ①
Pendant — One Hub, Rigid or Flexible Mounting			
	26	3/4	CJFPB2675BU
	32	3/4	CJFPB3275BU
	42	3/4	CJFPB4275BU

	25° Stanchion	One Hub		
		26	1-1/2	CJFSB26150BU
		32	1-1/2	CJFSB32150BU
	42	1-1/2	CJFSB42150BU	

Mounting Hoods		Hub Size Inches	Catalog Number
Pendant — One Hub			
		3/4	CAP-75B

	25° Stanchion — One Hub ②		
		1-1/2	CAS-150B

NOTE: Fixture units are the same as listed on following pages.

♦ Fixtures are for use with Group B atmospheres only when used with Group B mounting hoods. For 26 W, 32 W, and 42 W fixtures only.

① To order fixture with lamp(s), add suffix -L after voltage suffix.

② Malleable iron sealing fittings are available in the Fittings Section.

Code•Master™ PLT Factory Sealed Luminaires

Explosionproof, Dust-Ignitionproof





Integrally Ballasted. 26 W, 32 W, 42 W, 52 W, 64 W, 84 W Compact Fluorescent. For use with Threaded Metal Conduit.

NEC:

Class I, Division 1 and 2, Groups B♦, C, D
Class II, Division 1 and 2, Groups E, F, G
Class III
NEMA 4X
Suitable for use in wet locations

CEC:

Class I, Division 1 and 2, Groups B, C, D
Class II, Division 1 and 2, Groups E, F, G
Class III
CSA 4X

	Lamp Watts	Hub Size (Inches)	NEC Catalog Number with Globe ①③	CEC Catalog Number with Globe ①③
Pendant — One Hub, Rigid or Flexible Mounting				
	26 (1 x 26)	3/4	CJFP2675BU	CJFP2675A5
		1	CJFP2610BU	CJFP2610A5
	32 (1 x 32)	3/4	CJFP3275BU	CJFP3275A5
		1	CJFP3210BU	CJFP3210A5
	42 (1 x 42)	3/4	CJFP4275BU	CJFP4275A5
		1	CJFP4210BU	CJFP4210A5
	52 (2 x 26)	3/4	CFP5275BU	CFP5275A5
		1	CFP5210BU	CFP5210A5
	64 (2 x 32)	3/4	CFP6475BU	CFP6475A5
		1	CFP6410BU	CFP6410A5
84 (2 x 42)	3/4	CFP8475BU	CFP8475A5	
	1	CFP8410BU	CFP8410A5	
Ceiling — Four Hubs, Three Close-Up Plugs				
	26 (1 x 26)	3/4	CJFC2675BU	CJFC2675A5
		1	CJFC2610BU	CJFC2610A5
	32 (1 x 32)	3/4	CJFC3275BU	CJFC3275A5
		1	CJFC3210BU	CJFC3210A5
	42 (1 x 42)	3/4	CJFC4275BU	CJFC4275A5
		1	CJFC4210BU	CJFC4210A5
	52 (2 x 26)	3/4	CFC5275BU	CFC5275A5
		1	CFC5210BU	CFC5210A5
	64 (2 x 32)	3/4	CFC6475BU	CFC6475A5
		1	CFC6410BU	CFC6410A5
84 (2 x 42)	3/4	CFC8475BU	CFC8475A5	
	1	CFC8410BU	CFC8410A5	
Bracket — Four Hubs, Three Close-Up Plugs				
	26 (1 x 26)	3/4	CJFB2675BU	CJFB2675A5
		1	CJFB2610BU	CJFB2610A5
	32 (1 x 32)	3/4	CJFB3275BU	CJFB3275A5
		1	CJFB3210BU	CJFB3210A5
	42 (1 x 42)	3/4	CJFB4275BU	CJFB4275A5
		1	CJFB4210BU	CJFB4210A5
	52 (2 x 26)	3/4	CFB5275BU	CFB5275A5
		1	CFB5210BU	CFB5210A5
	64 (2 x 32)	3/4	CFB6475BU	CFB6475A5
		1	CFB6410BU	CFB6410A5
84 (2 x 42)	3/4	CFB8475BU	CFB8475A5	
	1	CFB8410BU	CFB8410A5	
25° Stanchion — One Hub				
	26 (1 x 26)	1-1/4 or 1-1/2 ②	CJFS26150BU	CJFS26150A5
	32 (1 x 32)	1-1/4 or 1-1/2 ②	CJFS32150BU	CJFS32150A5
	42 (1 x 42)	1-1/4 or 1-1/2 ②	CJFS42150BU	CJFS42150A5
	52 (2 x 26)	1-1/4 or 1-1/2 ②	CFS52150BU	CFS52150A5
	64 (2 x 32)	1-1/4 or 1-1/2 ②	CFS64150BU	CFS64150A5
	84 (2 x 42)	1-1/4 or 1-1/2 ②	CFS84150BU	CFS84150A5

♦ Fixtures are for use with Group B atmospheres only when used with Group B mounting hoods. For 26 W, 32 W, and 42 W fixtures only.

① To order fixture with guard, add suffix -G before adding voltage suffix. To order fixture with lamp(s), add suffix -L after voltage suffix.

② 1-1/2" tapped hub furnished with 1-1/2" to 1-1/4" reducer.

③ BU is 120 through 277 V, 50/60 Hz and 125 Vdc. A5 is 347 V, 60 Hz.

Shaded items are suitable for Class I, Group D ONLY.

Code•Master™ PLT Factory Sealed Luminaires





Explosionproof, Dust-Ignitionproof

Integrally Ballasted. 26 W, 32 W, 42 W, 52 W, 64 W, 84 W Compact Fluorescent. For use with Threaded Metal Conduit.



NEC:
 Class I, Division 1 and 2, Groups B♦, C, D
 Class II, Division 1 and 2, Groups E, F, G
 Class III
 NEMA 4X
 Suitable for use in wet locations

CEC:
 Class I, Division 1 and 2, Groups B, C, D
 Class II, Division 1 and 2, Groups E, F, G
 Class III
 CSA 4X

Mounting Hoods

	Hub Size (Inches)	Catalog Number
Pendant 	3/4	CAP-75
	1	CAP-100
Ceiling 	3/4	CAC-75
	1	CAC-100
Bracket 	3/4	CALB-75
	1	CALB-100
25° Stanchion 	1-1/4 or 1-1/2 ①	CAS-150 ①
Mounting Adapter with Connection Block 		CMAD-1

Fixture Units

	Line Voltage	Hz	Catalog Number
Ballast body with globe  26-42 W  52-84 W	120-277	50/60	CJB26FBU ②
	120-277	50/60	CJB32FBU ②
	120-277	50/60	CJB42FBU ②
	120-277	50/60	CMBF52BU
	120-277	50/60	CMBF64BU
	120-277	50/60	CMBF84BU

Electrical Specification

Lamp Wattage	Line Voltage	Frequency (Hz)	Line Amps	Input Watts	Min. Starting Temp
26 (1 x 26)	120-277	50/60	0.25-0.11	28	-18 °C (0 °F)
32 (1 x 32)	120-277	50/60	0.27-0.12	36	-18 °C (0 °F)
42 (1 x 42)	120-277	50/60	0.35-0.16	48	-18 °C (0 °F)
52 (2 x 26)	120-277	50/60	0.49-0.20	55	-30 °C (-22 °F)
64 (2 x 32)	120-277	50/60	0.57-0.24	67	-30 °C (-22 °F)
84 (2 x 42)	120-277	50/60	0.73-0.31	87	-30 °C (-22 °F)

♦ Fixtures are for use with Group B atmospheres only when used with Group B mounting hoods. For 26 W, 32 W, and 42 W fixtures only.

① 1-1/2" tapped hub furnished with 1-1/2" to 1-1/4" reducer.

② Denotes items that are suitable for Class I, Group B in addition to Class I, Groups C and D; and Class II, Groups E, F and G.

Shaded items are suitable for Class I, Group C in addition to Class I, Group D; Class II, Groups E, F and G; and Class III.

Appleton

FLUORESCENT/AREA: NEC/CEC EXPLOSIONPROOF

Code•Master™ PLT Factory Sealed Luminaires

Explosionproof, Dust-Ignitionproof









Integrally Ballasted. 26 W, 32 W, 42 W, 52 W, 64 W, 84 W Compact Fluorescent. For use with Threaded Metal Conduit.

NEC:

Class I, Division 1 and 2, Groups B♦, C, D
 Class II, Division 1 and 2, Groups E, F, G
 Class III
 NEMA 4X
 Suitable for use in wet locations

CEC:

Class I, Division 1 and 2, Groups B, C, D
 Class II, Division 1 and 2, Groups E, F, G
 Class III
 CSA 4X

Description		Catalog Number		
White Polyester Reflectors				
 Standard Dome	 30° Angle Dome	For Globe Fixtures		
		Standard Dome	26, 32, 42 W	KR2-ST
		30° Angle	26, 32, 42 W	KR2-AN
		Standard Dome	52, 64, 84 W	CMR-4ST
		30° Angle	52, 64, 84 W	CMR-4AN
	Deep Dome	52, 64, 84 W	CMR-4DD	
Aluminum Reflectors				
	High Bay	52, 64, 84 W	CMR-4HB	
Prismatic Glass Globe and Ring Assembly				
 CJGL-175	 CGL-400	26, 32, 42 W	CJGL-175	
		52, 64, 84 W	CGL-400	
Aluminum Guards				
 CJGU-15	 CGU-4	26, 32, 42 W	CJGU-15	
		52, 64, 84 W	CGU4	
Three-Way Exit Sign				
	Epoxy enameled steel — 6"-high red lettering Mounts to fixture units in place of guard.	26, 32, 42 W	CJEXRN	
		52, 64, 84 W	EXR400	
Single Sided Exit Sign				
	Epoxy enameled steel — 6"-high red lettering Mounts to fixture units in place of guard. <i>Contact your sales representative regarding hazardous location suitability.</i>	26, 32, 42 W	AEXR-15R	

♦ Fixtures are for use with Group B atmospheres only when used with Group B mounting hoods. For 26 W, 32 W, and 42 W fixtures only.

Code•Master™ PLT Factory Sealed Luminaires

Explosionproof, Dust-Ignitionproof



Integrally Ballasted. 26 W, 32 W, 42 W, 52 W, 64 W, 84 W Compact Fluorescent. For use with Threaded Metal Conduit.

NEC:
Class I, Division 1 and 2, Groups B♦, C, D
Class II, Division 1 and 2, Groups E, F, G
Class III
NEMA 4X
Suitable for use in wet locations

CEC:
Class I, Division 1 and 2, Groups B, C, D
Class II, Division 1 and 2, Groups E, F, G
Class III
CSA 4X

Description	Catalog Number
-------------	----------------

Replacement Parts – 26 W, 32 W, 42 W, 52 W, 64 W and 84 W

	Socket (lampholder) G24Q-4	26 thru 84 W	PLT32RS
	Single Socket Bracket Assembly	26, 32, 42 W	CJSA42
	Double Socket Bracket Assembly	52, 64, 84 W	CSA84

Lamps

	1 lamp = 26 W; 2 lamps = 52 W	26 W	PLT26
	1 lamp = 32 W; 2 lamps = 64 W	32 W	PLT32
	1 lamp = 42 W; 2 lamps = 84 W	42 W	PLT42

Connection Block

	For all Code•Master fixtures	VPT-7
---	------------------------------	--------------

Fixture and Accessory Weights kg (lb)

Fixture Size	Fixture Weight	Reflector Weight	Guard Weight
26 W, 32 W, 42 W	6.6 (14.55)	1.4 (3.09)	0.5 (1.10)
52 W, 64 W, 84 W	15.9 (35.05)	1.4 (3.09)	1.1 (2.43)

Mounting Hood Weights kg (lb)

Pendant	Ceiling	Bracket	Stanchion
0.9 (1.98)	1.8 (3.97)	2.7 (5.95)	0.9 (1.98)

Reflector Dimensions

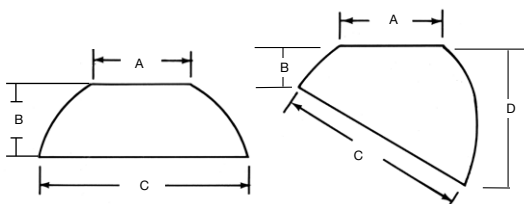
Catalog Number	Description	Dimensions in mm (in)				Standard and Deep Dome	30° Angle
		A	B	C	D		
Standard Dome							
KR2-ST	26, 32, 42 W	203.2 (8.00)	152.4 (6.00)	429.3 (16.90)	—		
CMR-4ST	52, 64, 84 W	284.5 (11.20)	149.9 (5.90)	475.0 (18.70)	—		
Deep Dome							
CMR-4DD	52, 64, 84 W	268.2 (10.56)	177.8 (7.00)	515.6 (20.30)	—		
30° Angle							
KR2-AN	26, 32, 42 W	203.2 (8.00)	69.9 (2.75)	378.5 (14.90)	258.3 (10.17)		
CMR-4AN	52, 64, 84 W	268.2 (10.56)	127 (5.00)	410.5 (16.16)	247.7 (9.75)		

♦ Fixtures are for use with Group B atmospheres only when used with Group B mounting hoods. For 26 W, 32 W, and 42 W fixtures only.

Code•Master™ PLT Factory Sealed Luminaires

Explosionproof, Dust-Ignitionproof

Integrally Ballasted. 26 W, 32 W, 42 W, 52 W, 64 W, 84 W Compact Fluorescent. For use with Threaded Metal Conduit.

NEC:

Class I, Division 1 and 2, Groups B♦, C, D
 Class II, Division 1 and 2, Groups E, F, G
 Class III
 NEMA 4X
 Suitable for use in wet locations

CEC:

Class I, Division 1 and 2, Groups B, C, D
 Class II, Division 1 and 2, Groups E, F, G
 Class III
 CSA 4X

Dimensions in Millimeters (Inches)

Mounting Hoods

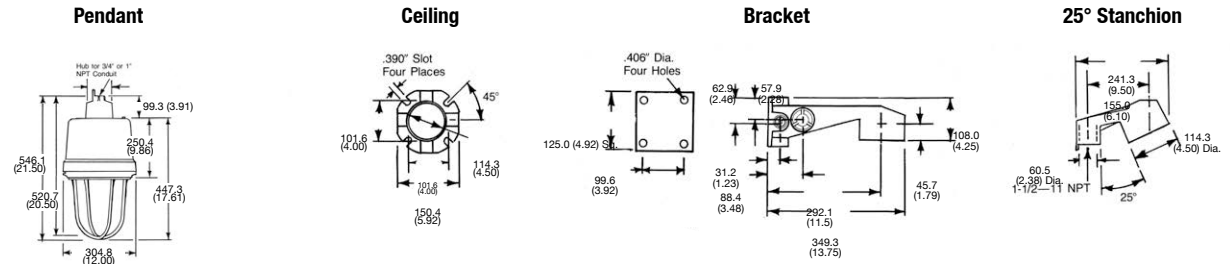

26, 32, 42 W Fixture

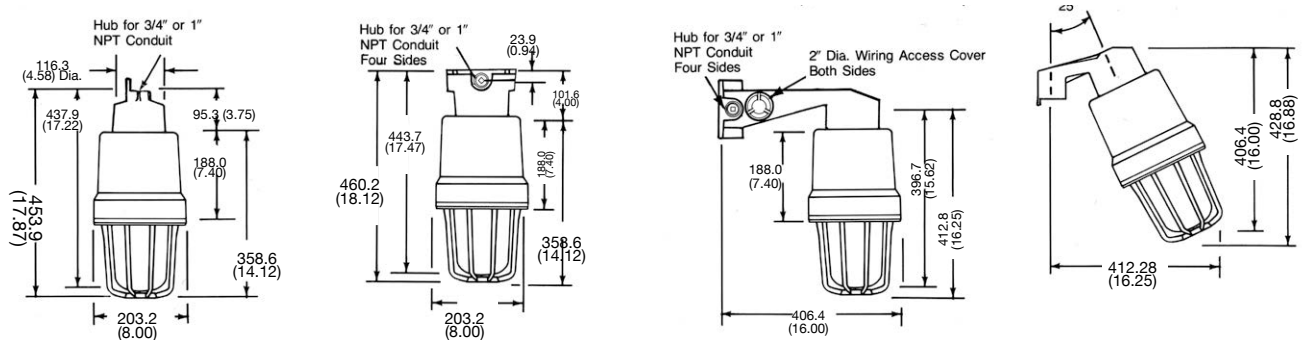

52, 64, 84 W Fixture

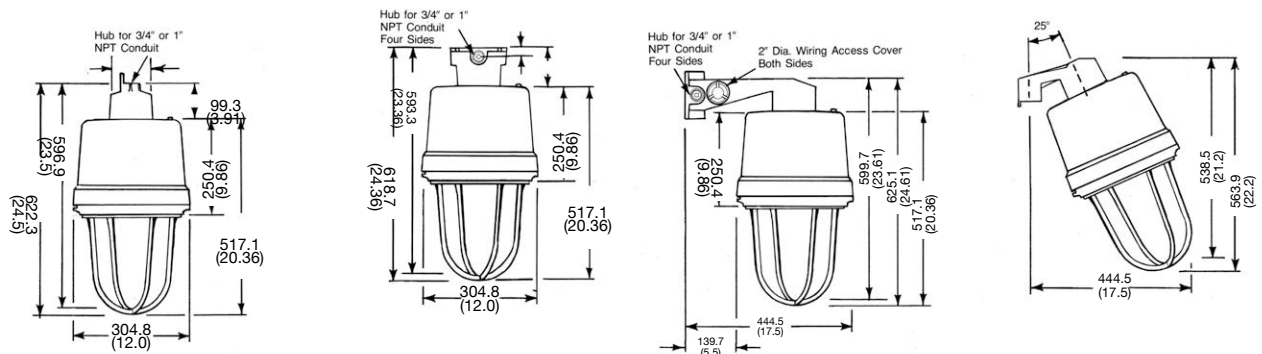

Exit Signs



♦ Fixtures are for use with Group B atmospheres only when used with Group B mounting hoods. For 26 W, 32 W, and 42 W fixtures only.

Code•Master™ PLT Factory Sealed Luminaires

Explosionproof, Dust-Ignitionproof

* Photometric data is based on a fixture with a 32 W compact fluorescent PL-T lamp (2,400 lumens). For candlepower values of fixtures with 26 W PL-T lamps (1,800 lumens), multiply by 0.75. For candlepower values of fixtures with a 42 W PL-T Lamp (3,200 lumens), multiply by 1.34.

NEC:
 Class I, Division 1 and 2, Groups B♦, C, D
 Class II, Division 1 and 2, Groups E, F, G
 Class III
 NEMA 4X
 Suitable for use in wet locations

CEC:
 Class I, Division 1 and 2, Groups B, C, D
 Class II, Division 1 and 2, Groups E, F, G
 Class III
 CSA 4X

Photometric Data

Total Luminaire Efficiency = 92.9%

CIE Type – Semi-Direct

Plane	Spacing Criteria
0-180	2.76
90-270	2.76
Diagonal	2.72

Zone	Lumens
------	--------

0-10	9.75
10-20	32.89
20-30	68.63
30-40	119.65
40-50	174.44
50-60	219.68
60-70	252.32
70-80	278.38
80-90	283.11
90-100	266.38
100-110	231.16
110-120	166.66
120-130	91.63
130-140	31.38
140-150	2.95
150-160	0.19
160-170	0.00
170-180	0.00

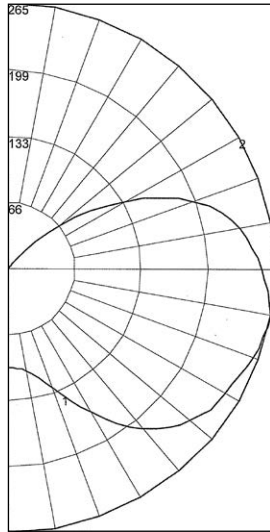

Maximum Candela = 265
 Located at Horizontal Angle = 0, Vertical Angle = 77.5
 #1 – Vertical Plane through Horizontal Angles (0–180) (Through Max. Cd.)
 #2 – Horizontal Cone through Vertical Angle (77.5) (Through Max. Cd.)

REPORT NUMBER: **CJBF32G**

32 W Fluorescent Lamp with Globe only *

Coefficients of Utilization – Zonal Cavity Method

Effective Floor Cavity Reflectance 0.20

% Ceiling	Rcc	80				70				50				30				10				0
		70	50	30	10	70	50	30	10	50	30	10	50	30	10	50	30	10	0			
0	103	103	103	103	97	97	97	97	85	85	85	74	74	74	65	65	65	65	60			
1	88	81	75	70	82	76	70	65	65	61	57	56	53	50	48	45	42	38	38			
2	78	67	59	52	72	63	55	49	54	48	43	46	41	37	38	35	31	27	27			
3	69	57	48	41	64	53	45	38	46	39	33	39	33	29	32	28	24	20	20			
4	63	50	40	33	58	46	37	31	39	32	27	33	28	23	28	23	19	16	16			
5	57	43	34	27	52	40	32	25	35	27	22	29	23	19	24	19	16	13	13			
6	52	38	29	23	48	36	27	21	31	24	18	26	20	16	21	17	13	10	10			
7	48	34	25	19	44	32	24	18	27	21	16	23	18	13	19	15	11	9	9			
8	44	31	22	17	41	29	21	16	25	18	14	21	16	11	18	13	9	7	7			
9	41	28	20	14	38	26	19	14	23	16	12	19	14	10	16	12	8	6	6			
10	38	25	18	13	35	24	17	12	21	15	10	18	12	9	15	10	7	5	5			

Zonal Lumen Summary

Zone	Lumens	% Lamp	% Fixture	Zone	Lumens	% Lamp	% Fixture
0-30	111.27	4.6	5.0	90-120	664.20	27.7	29.8
0-40	230.92	9.6	10.4	90-130	755.83	31.5	33.9
0-60	625.05	26.0	28.0	90-150	790.17	32.9	33.9
0-90	1438.87	60.0	64.5	90-180	790.36	32.9	35.5
				0-180	2229.23	92.9	100.0

Total Luminaire Efficiency = 80.7%

CIE Type – Direct

Plane	Spacing Criteria
0-180	1.42
90-270	1.42
Diagonal	1.60

Zone	Lumens
------	--------

0-10	51.88
10-20	151.03
20-30	240.04
30-40	312.02
40-50	361.09
50-60	377.88
60-70	278.20
70-80	119.22
80-90	23.81
90-100	0.68
100-110	4.48
110-120	6.82
120-130	5.50
130-140	3.07
140-150	0.09
150-160	0.00
160-170	0.00
170-180	0.00

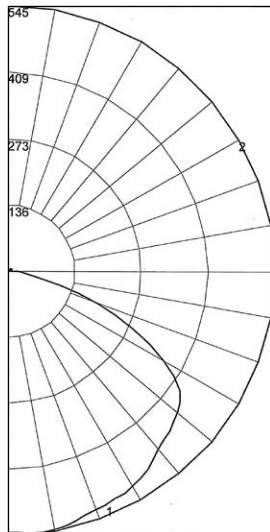

Maximum Candela = 545
 Located at Horizontal Angle = 0, Vertical Angle = 5
 #1 – Vertical Plane through Horizontal Angles (0–180) (Through Max. Cd.)
 #2 – Horizontal Cone through Vertical Angle (5) (Through Max. Cd.)

REPORT NUMBER: **CJBF32ST**

32 W Fluorescent Lamp with Globe and Standard Dome Reflector *

Coefficients of Utilization – Zonal Cavity Method

Effective Floor Cavity Reflectance 0.20

% Ceiling	Rcc	80				70				50				30				10				0
		70	50	30	10	70	50	30	10	50	30	10	50	30	10	50	30	10	0			
0	96	96	96	96	93	93	93	93	89	89	89	85	85	85	82	82	82	80	80			
1	87	84	80	77	85	82	78	76	78	75	73	75	73	71	72	70	68	67	67			
2	79	72	67	62	77	71	66	61	68	63	60	65	61	58	62	59	57	55	55			
3	72	63	56	51	70	62	55	50	59	54	49	57	52	48	54	51	47	45	45			
4	65	55	48	42	63	54	47	42	52	46	41	50	45	41	48	44	40	38	38			
5	60	49	41	36	58	48	41	36	46	40	35	44	39	35	43	38	34	32	32			
6	55	44	36	31	53	43	36	31	41	35	30	40	34	30	39	34	30	28	28			
7	51	39	32	27	49	39	32	27	37	31	27	36	30	26	35	30	26	24	24			
8	47	36	29	24	46	35	28	24	34	28	23	33	27	23	32	27	23	21	21			
9	44	33	26	21	43	32	26	21	31	25	21	30	25	21	29	24	21	19	19			
10	41	30	23	19	40	30	23	19	29	23	19	28	23	19	27	22	19	17	17			

Zonal Lumen Summary

Zone	Lumens	% Lamp	% Fixture	Zone	Lumens	% Lamp	% Fixture
0-30	442.95	18.5	22.9	90-120	11.98	0.5	0.6
0-40	754.97	31.5	39.0	90-130	17.48	0.7	0.9
0-60	1493.95	62.2	77.2	90-150	20.63	0.9	0.9
0-90	1915.18	79.8	98.9	90-180	20.63	0.9	1.1
				0-180	1935.81	80.7	100.0

◆ Fixtures are for use with Group B atmospheres only when used with Group B mounting hoods. For 26 W, 32 W, and 42 W fixtures only.

Code•Master™ PLT Factory Sealed Luminaires

Explosionproof, Dust-Ignitionproof

* Photometric data is based on a fixture with a 32 W compact fluorescent PL-T lamp (2,400 lumens). For candlepower values of fixtures with 26 W PL-T lamps (1,800 lumens), multiply by 0.75. For candlepower values of fixtures with a 42 W PL-T Lamp (3,200 lumens), multiply by 1.34. ** Photometric data is based on a fixture with two 32 W Compact Fluorescent PL-T lamps (2,400 lumens each). For candlepower values of fixtures with two 26 W PL-T lamps (1,800 lumens each), multiply by 0.75. For Candlepower values of fixtures with two 42 W PL-T Lamps. (3,200 lumens each) multiply by 1.34.

NEC:

Class I, Division 1 and 2, Groups B, C, D
Class II, Division 1 and 2, Groups E, F, G
Class III
NEMA 4X
Suitable for use in wet locations

CEC:

Class I, Division 1 and 2, Groups B, C, D
Class II, Division 1 and 2, Groups E, F, G
Class III
GSA 4X

Photometric Data

Total Luminaire Efficiency = 76.6%

CIE Type – Direct

Plane	Spacing Criteria
0-180	1.48
90-270	1.62
Diagonal	1.54

Zone	Lumens
0-10	42.08
10-20	124.46
20-30	205.20
30-40	273.31
40-50	299.53
50-60	283.93
60-70	240.60
70-80	181.91
80-90	110.47
90-100	50.28
100-110	18.05
110-120	5.01
120-130	1.80
130-140	1.13
140-150	0.05
150-160	0.00
160-170	0.00
170-180	0.00

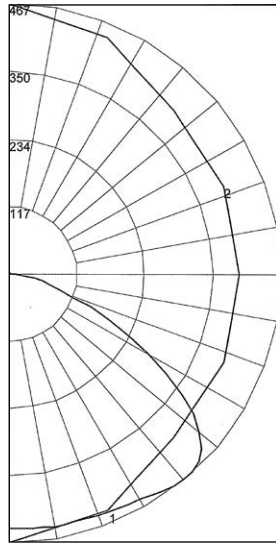

Maximum Candela = 467
 Located at Horizontal Angle = 90, Vertical Angle = 40
 #1 – Vertical Plane through Horizontal Angles (90–270) (Through Max. Cd.)
 #2 – Horizontal Cone through Vertical Angle (40) (Through Max. Cd.)

REPORT NUMBER: **CJBF32AN**

32 W Fluorescent Lamp with Globe and 30° Angle Dome Reflector *

Coefficients of Utilization – Zonal Cavity Method

Effective Floor Cavity Reflectance 0.20

% Ceiling % Walls	Rcc Rw	80				70				50				30				10				0
		70	50	30	10	70	50	30	10	50	30	10	50	30	10	50	30	10	0			
0	0	90	90	90	90	88	88	88	88	83	83	83	79	79	79	75	75	75	73	0		
1	1	81	76	72	69	78	74	71	67	70	67	64	67	64	62	63	61	59	58	0		
2	2	73	65	59	54	70	64	58	53	60	56	52	57	53	50	54	51	48	46	0		
3	3	66	57	50	44	63	55	49	44	52	47	42	50	45	41	47	43	40	38	0		
4	4	60	50	42	37	58	48	42	36	46	40	35	44	39	35	42	37	34	32	0		
5	5	55	44	37	31	53	43	36	31	41	35	30	39	34	30	37	33	29	27	0		
6	6	50	39	32	27	49	39	32	27	37	31	26	35	30	26	34	29	25	23	0		
7	7	47	36	28	23	45	35	28	23	33	27	23	32	26	22	31	26	22	20	0		
8	8	43	32	25	21	42	32	25	21	30	24	20	29	24	20	28	23	20	18	0		
9	9	40	30	23	18	39	29	23	18	28	22	18	27	22	18	26	21	18	16	0		
10	10	38	27	21	17	36	27	21	17	26	20	16	25	20	16	24	19	16	14	0		

Zonal Lumen Summary

Zone	Lumens	% Lamp	% Fixture	Zone	Lumens	% Lamp	% Fixture
0-30	371.75	15.5	20.2	90-120	73.34	3.1	4.0
0-40	645.06	26.9	35.1	90-130	75.13	3.1	4.1
0-60	1228.52	51.2	66.8	90-150	76.32	3.2	4.1
0-90	1761.50	73.4	95.8	90-180	76.32	3.2	4.2
				0-180	1837.81	76.6	100.0

Total Luminaire Efficiency = 79.8%

CIE Type – Semi-Direct

Plane	Spacing Criteria
0-180	2.88
90-270	2.88
Diagonal	2.82

Zone	Lumens
0-10	17.70
10-20	61.05
20-30	132.44
30-40	236.78
40-50	336.66
50-60	421.68
60-70	485.34
70-80	517.29
80-90	513.72
90-100	468.70
100-110	352.77
110-120	200.85
120-130	73.54
130-140	11.28
140-150	1.12
150-160	0.31
160-170	0.06
170-180	0.00

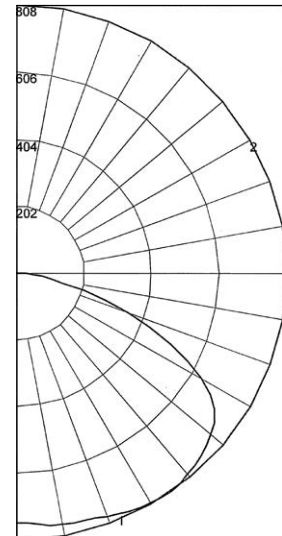

Maximum Candela = 493
 Located at Horizontal Angle = 0, Vertical Angle = 70
 #1 – Vertical Plane through Horizontal Angles (0–180) (Through Max. Cd.)
 #2 – Horizontal Cone through Vertical Angle (70) (Through Max. Cd.)

REPORT NUMBER: **CMBF64G**

64 W (two 32 W lamps) Fluorescent Fixture with Globe only **

Coefficients of Utilization – Zonal Cavity Method

Effective Floor Cavity Reflectance 0.20

% Ceiling % Walls	Rcc Rw	80				70				50				30				10				0
		70	50	30	10	70	50	30	10	50	30	10	50	30	10	50	30	10	0			
0	0	90	90	90	90	85	85	85	85	76	76	76	68	68	68	60	60	60	57	0		
1	1	76	70	65	60	71	66	61	57	58	54	51	51	48	45	45	42	40	36	0		
2	2	67	58	51	45	63	55	48	42	48	43	38	42	37	34	36	32	29	26	0		
3	3	60	49	41	35	56	46	39	33	40	34	29	35	30	26	30	26	23	20	0		
4	4	54	43	34	28	50	40	32	26	35	28	23	30	25	21	26	21	18	15	0		
5	5	49	37	29	23	46	35	27	22	31	24	19	26	21	17	23	18	15	12	0		
6	6	45	33	25	19	42	31	23	18	27	21	16	23	18	14	20	16	12	10	0		
7	7	41	29	22	16	38	28	20	15	24	18	14	21	16	12	18	14	10	8	0		
8	8	38	26	19	14	36	25	18	13	22	16	12	19	14	10	16	12	9	7	0		
9	9	35	24	17	12	33	23	16	11	20	14	10	17	12	9	15	11	8	9	0		
10	10	33	22	15	11	31	21	14	10	18	13	9	16	11	8	14	10	7	5	0		

Zonal Lumen Summary

Zone	Lumens	% Lamp	% Fixture	Zone	Lumens	% Lamp	% Fixture
0-30	211.19	4.4	5.5	90-120	1022.32	21.3	26.7
0-40	447.97	9.3	11.7	90-130	1095.85	22.8	28.6
0-60	1206.31	25.1	31.5	90-150	1108.26	23.1	28.6
0-90	2722.64	56.7	71.1	90-180	1108.63	23.1	28.9
				0-180	3831.28	79.8	100.0

◆ Fixtures are for use with Group B atmospheres only when used with Group B mounting hoods. For 26 W, 32 W, and 42 W fixtures only.

Code•Master™ PLT Factory Sealed Luminaires

Explosionproof, Dust-Ignitionproof

** Photometric data is based on a fixture with two 32 W Compact Fluorescent PL-T lamps (2,400 lumens each). For candlepower values of fixtures with two 26 W PL-T lamps (1,800 lumens each), multiply by 0.75. For Candlepower values of fixtures with two 42 W PL-T lamps. (3,200 lumens each) multiply by 1.34.

NEC:
 Class I, Division 1 and 2, Groups B♦, C, D
 Class II, Division 1 and 2, Groups E, F, G
 Class III
 NEMA 4X
 Suitable for use in wet locations

CEC:
 Class I, Division 1 and 2, Groups B, C, D
 Class II, Division 1 and 2, Groups E, F, G
 Class III
 CSA 4X

Photometric Data

Total Luminaire Efficiency = 66.5%

CIE Type – Direct

Plane	Spacing Criteria
0-180	1.62
90-270	1.62
Diagonal	1.74

Zone Lumens

0-10	73.25
10-20	220.57
20-30	368.60
30-40	505.61
40-50	603.19
50-60	638.42
60-70	497.24
70-80	226.17
80-90	57.98
90-100	1.64
100-110	0.00
110-120	0.00
120-130	0.00
130-140	0.00
140-150	0.00
150-160	0.00
160-170	0.00
170-180	0.00

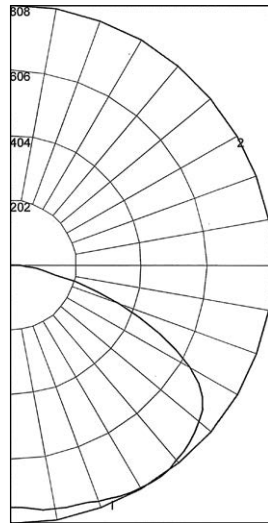

Maximum Candela = 808
 Located at Horizontal Angle = 0, Vertical Angle = 35
 #1 – Vertical Plane through Horizontal Angles (0–180)
 (Through Max. Cd.)
 #2 – Horizontal Cone through Vertical Angle (35)
 (Through Max. Cd.)

REPORT NUMBER: CMBF64ST

64 W (two 32 W lamps) Fluorescent Fixture with Globe and Standard Dome Reflector **

Coefficients of Utilization – Zonal Cavity Method

Effective Floor Cavity Reflectance 0.20

% Ceiling	Rcc	80				70				50				30				10				0												
		70	50	30	10	70	50	30	10	50	30	10	50	30	10	50	30	10																
% Walls	Rw	0	1	2	3	4	5	6	7	8	9	10	0	1	2	3	4	5	6	7	8	9	10	0	1	2	3	4	5	6	7	8	9	10
		79	79	66	63	77	77	64	62	74	74	60	62	60	58	59	58	56	55	48	46	45	44	41	38	37	30	26	23	22	19	17	15	13

Zonal Lumen Summary

Zone	Lumens	% Lamp	% Fixture	Zone	Lumens	% Lamp	% Fixture
0-30	662.42	13.8	20.7	90-120	1.64	0.0	0.1
0-40	1168.03	24.3	36.6	90-130	1.64	0.0	0.1
0-60	2409.64	50.2	75.5	90-150	1.64	0.0	0.1
0-90	3191.04	66.5	99.9	90-180	1.64	0.0	0.1
0-180	3192.68	66.5	100.0				

Total Luminaire Efficiency = 57.4%

CIE Type – Direct

Plane	Spacing Criteria
0-180	1.52
90-270	1.70
Diagonal	1.62

Zone Lumens

0-10	62.13
10-20	187.93
20-30	317.49
30-40	428.14
40-50	471.22
50-60	454.23
60-70	384.77
70-80	276.31
80-90	157.68
90-100	13.45
100-110	0.00
110-120	0.00
120-130	0.00
130-140	0.00
140-150	0.00
150-160	0.00
160-170	0.00
170-180	0.00

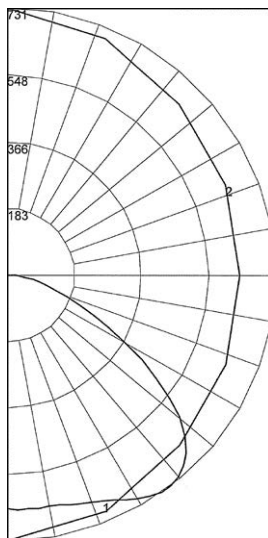

Maximum Candela = 731
 Located at Horizontal Angle = 90, Vertical Angle = 37.5
 #1 – Vertical Plane through Horizontal Angles (90–270)
 (Through Max. Cd.)
 #2 – Horizontal Cone through Vertical Angle (37.5)
 (Through Max. Cd.)

REPORT NUMBER: CMBF64AN

64 W (two 32 W lamps) Fluorescent Fixture with Globe and 30° Angle Dome Reflector **

Coefficients of Utilization – Zonal Cavity Method

Effective Floor Cavity Reflectance 0.20

% Ceiling	Rcc	80				70				50				30				10				0												
		70	50	30	10	70	50	30	10	50	30	10	50	30	10	50	30	10																
% Walls	Rw	0	1	2	3	4	5	6	7	8	9	10	0	1	2	3	4	5	6	7	8	9	10	0	1	2	3	4	5	6	7	8	9	10
		68	68	55	52	67	67	54	51	64	64	49	48	48	48	48	48	46	45	41	39	36	37	34	31	30	25	22	21	18	16	14	12	

Zonal Lumen Summary

Zone	Lumens	% Lamp	% Fixture	Zone	Lumens	% Lamp	% Fixture
0-30	567.55	11.8	20.6	90-120	13.45	0.3	0.5
0-40	995.69	20.7	36.2	90-130	13.45	0.3	0.5
0-60	1921.14	40.0	69.8	90-150	13.45	0.3	0.5
0-90	2739.90	57.1	99.5	90-180	13.45	0.3	0.5
0-180	2753.35	57.4	100.0				

♦ Fixtures are for use with Group B atmospheres only when used with Group B mounting hoods. For 26 W, 32 W, and 42 W fixtures only.

Code•Master™ PLT Factory Sealed Luminaires

Explosionproof, Dust-Ignitionproof

** Photometric data is based on a fixture with two 32 W Compact Fluorescent PL-T lamps (2,400 lumens each). For candlepower values of fixtures with two 26 W PL-T lamps (1,800 lumens each), multiply by 0.75. For Candlepower values of fixtures with two 42 W PL-T Lamps, (3,200 lumens each) multiply by 1.34.

NEC:
 Class I, Division 1 and 2, Groups B♦, C, D
 Class II, Division 1 and 2, Groups E, F, G
 Class III
 NEMA 4X
 Suitable for use in wet locations

CEC:
 Class I, Division 1 and 2, Groups B, C, D
 Class II, Division 1 and 2, Groups E, F, G
 Class III
 CSA 4X

Photometric Data

Total Luminaire Efficiency = 67.2%

CIE Type – Direct

Plane	Spacing Criteria
0-180	1.44
90-270	1.44
Diagonal	1.60

Zone	Lumens
0-10	88.95
10-20	260.61
20-30	413.34
30-40	539.82
40-50	630.36
50-60	641.74
60-70	436.60
70-80	164.84
80-90	47.37
90-100	1.92
100-110	0.00
110-120	0.00
120-130	0.00
130-140	0.00
140-150	0.00
150-160	0.00
160-170	0.00
170-180	0.00

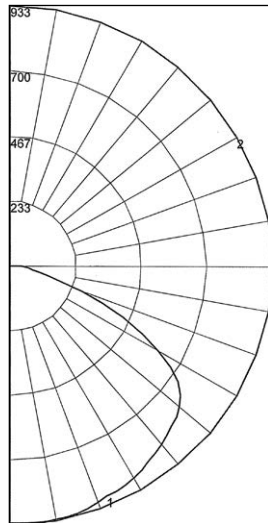

Maximum Candela = 933
 Located at Horizontal Angle = 0, Vertical Angle = 7.5
 #1 – Vertical Plane through Horizontal Angles (0–180)
 (Through Max. Cd.)
 #2 – Horizontal Cone through Vertical Angle (7.5)
 (Through Max. Cd.)

REPORT NUMBER: **CMBF64DD**

64 W (two 32 W lamps) Fluorescent Fixture with Globe and Deep Dome Reflector **

Coefficients of Utilization – Zonal Cavity Method

		Effective Floor Cavity Reflectance 0.20																							
% Ceiling	Rcc	80				70				50				30				10				0			
		70	50	30	10	70	50	30	10	50	30	10	50	30	10	50	30	10	50	30	10				
% Walls	Rw	70	50	30	10	70	50	30	10	50	30	10	50	30	10	50	30	10	50	30	10	50	30	10	
0	80	80	80	80	80	78	78	78	78	75	75	75	71	71	71	69	69	69	67	67	67	67	67	67	
1	73	70	67	65	65	71	68	66	63	66	63	61	63	61	60	60	59	58	56	56	56	56	56	56	
2	66	61	56	52	52	65	59	55	52	57	53	50	55	52	49	48	44	41	46	43	40	39	39	39	
3	60	53	47	43	43	59	52	47	43	50	45	42	48	44	41	46	44	41	46	43	40	37	37	37	
4	55	47	41	36	36	53	46	40	36	44	39	35	42	38	35	41	37	34	33	33	33	33	33	33	
5	50	41	35	31	31	49	41	35	30	39	34	30	38	33	30	37	33	29	28	28	28	28	28	28	
6	46	37	31	26	26	45	36	30	26	35	30	26	34	29	26	33	29	25	24	24	24	24	24	24	
7	43	33	27	23	23	41	33	27	23	32	27	23	31	26	23	30	26	22	21	21	21	21	21	21	
8	40	30	24	20	20	38	30	24	20	29	24	20	28	23	20	27	23	20	19	19	19	19	19	19	
9	37	28	22	18	18	36	27	22	18	26	21	18	26	21	18	25	21	18	16	16	16	16	16	16	
10	34	25	20	16	16	34	25	20	16	24	19	16	24	19	16	23	19	16	15	15	15	15	15	15	

Zonal Lumen Summary

Zone	Lumens	% Lamp	% Fixture	Zone	Lumens	% Lamp	% Fixture
0-30	762.91	15.9	23.7	90-120	1.92	0.0	0.1
0-40	1302.73	27.1	40.4	90-130	1.92	0.0	0.1
0-60	2574.82	53.6	79.8	90-150	1.92	0.0	0.1
0-90	3223.63	67.2	99.9	90-180	1.92	0.0	0.1
				0-180	3225.55	57.4	100.0

Total Luminaire Efficiency = 58.9%

CIE Type – Direct

Plane	Spacing Criteria
0-180	0.82
90-270	0.82
Diagonal	0.92

Zone	Lumens
0-10	239.15
10-20	599.67
20-30	645.20
30-40	625.54
40-50	452.95
50-60	185.71
60-70	58.40
70-80	15.26
80-90	4.25
90-100	0.69
100-110	0.00
110-120	0.00
120-130	0.00
130-140	0.00
140-150	0.00
150-160	0.00
160-170	0.00
170-180	0.00

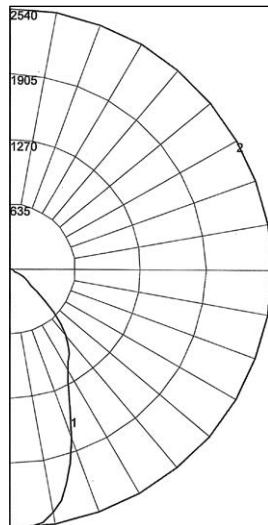

Maximum Candela = 2540
 Located at Horizontal Angle = 0, Vertical Angle = 5
 #1 – Vertical Plane through Horizontal Angles (0–180)
 (Through Max. Cd.)
 #2 – Horizontal Cone through Vertical Angle (5)
 (Through Max. Cd.)

REPORT NUMBER: **CMBF64HB**

64 W (two 32 W lamps) Fluorescent Fixture with Globe and High Bay Reflector **

Coefficients of Utilization – Zonal Cavity Method

		Effective Floor Cavity Reflectance 0.20																							
% Ceiling	Rcc	80				70				50				30				10				0			
		70	50	30	10	70	50	30	10	50	30	10	50	30	10	50	30	10	50	30	10				
% Walls	Rw	70	50	30	10	70	50	30	10	50	30	10	50	30	10	50	30	10	50	30	10	50	30	10	
0	70	70	70	70	70	68	68	68	68	65	65	65	63	63	63	60	60	60	59	59	59	59	59	59	
1	66	64	63	61	61	65	63	62	60	61	59	58	58	57	57	56	56	55	54	54	54	54	54	54	
2	62	59	56	54	54	61	58	55	53	56	54	52	54	52	51	52	51	50	49	49	49	49	49	49	
3	58	54	51	48	48	57	53	50	47	51	49	47	50	48	46	49	47	45	44	44	44	44	44	44	
4	55	50	46	43	43	54	49	45	43	48	44	42	46	44	42	45	43	41	40	40	40	40	40	40	
5	51	46	42	39	39	50	45	41	39	44	41	38	43	40	38	42	39	37	36	36	36	36	36	36	
6	48	42	38	35	35	47	42	38	35	41	37	35	40	37	35	39	36	34	33	33	33	33	33	33	
7	46	39	35	32	32	45	39	35	32	38	35	32	37	34	32	37	34	32	31	31	31	31	31	31	
8	43	37	33	30	30	42	36	32	30	36	32	30	35	32	29	34	31	29	28	28	28	28	28	28	
9	41	34	30	28	28	40	34	30	28	33	30	27	33	30	27	32	29	27	26	26	26	26	26	26	
10	38	32	28	26	26	38	32	28	26	31	28	26	31	28	25	30	27	25	25	25	25	25	25	25	

Zonal Lumen Summary

Zone	Lumens	% Lamp	% Fixture	Zone	Lumens	% Lamp	% Fixture
0-30	1484.03	30.9	52.5	90-120	0.69	0.0	0.0
0-40	2109.57	43.9	74.6	90-130	0.69	0.0	0.0
0-60	2748.23	57.3	97.2	90-150	0.69	0.0	0.0
0-90	2826.12	58.9	100.0	90-180	0.69	0.0	0.0
				0-180	2628.80	58.9	100.0

♦ Fixtures are for use with Group B atmospheres only when used with Group B mounting hoods. For 26 W, 32 W, and 42 W fixtures only.

ELS Series Emergency Lighting System

Explosionproof, Dust-Ignitionproof

Remote and direct mounted fixtures for hazardous location applications

NEC:

Class I, Division 1 and 2, Groups B ①, C, D

Class II, Division 1 and 2, Groups E, F, G

Class III

Applications

- ELS Series features an emergency lighting power unit that is designed to provide safe operation in the presence of hazardous gases, vapors or dusts, defined by the National Electrical Code as Class I, Groups C and D, and Class II, Groups E, F and G.
- Typical applications include all means of egress (such as walkways, exit ramps, stairs and aisles) for hazardous areas which include oil refineries, petrochemical facilities, pulp and paper mills, chemical storage areas, wastewater treatment facilities and grain elevators.

Features

- The electronics consist of a solid-state charger, transfer circuit and low-voltage battery disconnect circuit.
- The unit test switch and AC "On" indicator light are housed in a separate module that may be attached directly to the unit housing or mounted remotely for ease of testing.
- All ELS Series units are rated for operation in NEC Class I, Division 1 and 2, Groups C and D; and Class II, Division 1 and 2, Groups E, F, and G environments.
- Housing provisions allow for the attachment of two optional explosionproof lighting fixtures.
- Unit capacity is sufficient for the connection of up to four 6- or 12- volt, 18-watt fixtures.
- Units provide 90 minutes of emergency operation.
- The solid-state charger maintains battery at full charge.
- Upon failure of utility voltage, the DC emergency lighting load is connected to the battery.
- During emergency operation, automatic battery protection from deep discharge damage is provided by a low-voltage battery disconnect (LVD) circuit.
- Upon restoration of normal power, the charger will begin a recharge cycle. It will bring the battery to full capacity within acceptable UL time standards.
- A pilot light indicates the presence of AC line voltage, and a test switch is provided for checking transfer operation. Lock-out type guard on push button accepts locks with up to 6.5 mm (1/4 in) hasp.
- A universal transformer allows operation on 120 or 277 Vac lines.
- Emergency power source is a maintenance-free, sealed, pure-lead battery suited for harsh temperature environments for 0 °C to +40 °C (+32 °F to +104 °F).
 - Never necessary to add water.
 - Expected life is 10 years
 - Compact in design
- Standard illumination is provided during power failure only using fixtures specially designed for emergency lighting in hazardous environments, supplied with double contact bayonet base 18- or 28-watt incandescent lamps.
- Designed for easy installation. Provided with 4 mounting holes for attachment to a wall or other suitable surface. Mounting hardware not included.
- Housing is drilled and tapped for installation of utility 12.7 mm (1/2 in) NPT conduit.
- Quick access to internal wiring and components is provided by thread-on cover.
- All necessary fittings for test switch/ pilot light module supplied standard.



Standard Materials

- Battery enclosure, fixtures, guards and pendant mount: copperfree (4/10 of 1% max.) aluminum.
- Ceiling and bracket mounts: malleable iron with aluminum adapter
- Reflectors: porcelain enameled steel
- Test Switch: copperfree (4/10 of 1% max.) aluminum with stainless steel hardware

Standard Finishes

- Enclosure, fixtures and test station: epoxy powder coat finish electrostatically applied for complete and uniform surface protection
- Reflectors: white porcelain enamel

Options

- The fixture may be adapted to serve as an exit sign through use of an Auxiliary Exit Housing.
- Time Delay Relay (15 minutes) available to permit normal lighting to re-establish brightness. Add suffix -T1 for 120 Vac, or -T2 for 277 Vac.

NEC Certifications and Compliances

- UL Standard: UL 924, UL 844, UL 1598
- UL Listed: 175025

① Contact your sales representative for Class I, Group B rating.

ELS Series Emergency Lighting System

Explosionproof, Dust-Ignitionproof

Remote and direct mounted fixtures for hazardous location applications

NEC:

Class I, Division 1 and 2, Groups B ①, C, D
 Class II, Division 1 and 2, Groups E, F, G
 Class III

Order using catalog numbering guide below or select catalog number from tables on following pages.

Catalog Numbering Guide

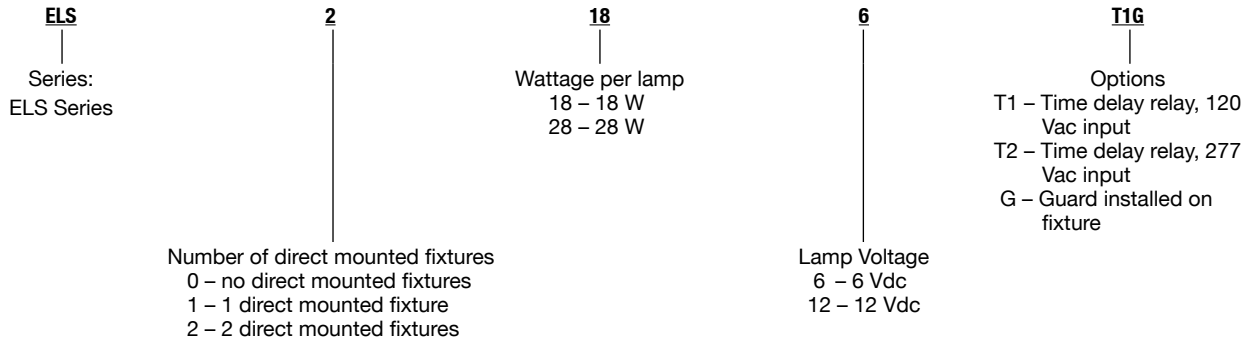

Capacity of standard ELS unit (75 W for 90 minutes)

Up to 2 fixtures may be direct mounted. The remainder must be remote mounted.

Combination Number	Number of Fixtures	Wattage per Fixture	Total Wattage
1	1	18	18
2	1	28	28
3	2	18	36
4	2	28	56
5	3	18	54
6	1	28	64
6	2	18	64
7	4	18	72

Lamp Watts	Supply Wire Temp °C (°F)	Ambient Temp °C (°F)	Class I, Division 1 and 2 Operating Temperature	Class II, Division 1 and 2 (Groups E, F and G) Operating Temperature
18	125 (257)	40 (104)	T5	T3C
28	125 (257)	40 (104)	T5	T3C

“T” Numbers Represent the Maximum Surface Temperature for Class I, Division 1 Locations and Maximum Surface Temperature Under Dust Blanket for Class II, Division 1 Locations.

NOTE: The maximum operating temperature of the fixture must not exceed the ignition temperature of the gas, vapor or dust to be encountered per the National Electrical Code. Operating temperatures are with and without reflectors and guards.

“T” Number	T1	350	325	T2	T2A	T2B	T2C	T2D	T3	T3A	T3B	T3C	T4	T4A	T5	T6
Temp. Range (°C)	351-450	326-350	301-325	281-300	261-280	231-260	216-230	201-215	181-200	166-180	161-165	136-160	121-135	101-120	86-100	85
Temp Range (°F)	664-842	619-662	574-617	538-572	502-536	448-500	421-446	394-419	358-392	331-356	322-329	277-320	250-275	214-248	187-212	185

① Contact your sales representative for Class I, Group B rating.

ELS Series Emergency Lighting System

Explosionproof, Dust-Ignitionproof

Remote and direct mounted fixtures for hazardous location applications

NEC:

Class I, Division 1 and 2, Groups C, D
 Class II, Division 1 and 2, Groups E, F, G
 Class III

Emergency Lighting System with Direct Mounted Fixtures

	Number of Fixtures	Watts per Lamp	Lamp Voltage	Input Voltage	Catalog Number (Lamp(s) Included)
	2	18	6 Vdc	120/277 Vac	ELS2186 ①②③④
	2	28	6 Vdc	120/277 Vac	ELS2286 ①②③④
	2	18	12 Vdc	120/277 Vac	ELS21812 ①②③④
	2	28	12 Vdc	120/277 Vac	ELS22812 ①②③④
	1	18	6 Vdc	120/277 Vac	ELS1186 ②③④
	1	28	6 Vdc	120/277 Vac	ELS1286 ①②③④
	1	18	12 Vdc	120/277 Vac	ELS11812 ①②③④
	1	28	12 Vdc	120/277 Vac	ELS12812 ①②③④

Emergency Lighting System Enclosure with Battery and Charger

	Lamp Voltage	Input Voltage	Catalog Number with Push-to-Test (Incl. Fittings)
	6 Vdc	120/277 Vac	ELS06 ①②③
	12 Vdc	120/277 Vac	ELS012 ①②③

Emergency Lighting System Fixture for Direct Mounting to Enclosure Includes all necessary fittings and lamp.

	Watts Per Lamp	Lamp Voltage	Catalog Number (Lamp Included)
	18	6 Vdc	AP1050-186-DM ④
	28	6 Vdc	AP1050-286-DM ④
	18	12 Vdc	AP1050-1812-DM ④
	28	12 Vdc	AP1050-2812-DM ④

① 1/2" NPT provided for AC input.

② Add suffix **T1** for time delay relay for 120 Vac input.

③ Add suffix **T2** for time delay relay for 277 Vac input.

④ To order fixtures with guard installed add suffix **-G**. Reflectors and exit signs are ordered separately. See Accessories page.

ELS Series Emergency Lighting System





Explosionproof, Dust-Ignitionproof

Remote and direct mounted fixtures for hazardous location applications

NEC:

Class I, Division 1 and 2, Groups C, D
 Class II, Division 1 and 2, Groups E, F, G
 Class III

Emergency Lighting System Fixture for Remote Mounting — Lamp Included — Shown with Optional Guard

	Mounting Type	Watts Per Lamp	Lamp Voltage	Catalog Number (Lamp Included) ①
Pendant — One 1/2" Hub				
		18	6 Vdc	AP1050-186
		28	6 Vdc	AP1050-286
		18	12 Vdc	AP1050-1812
		28	12 Vdc	AP1050-2812
Ceiling — Four 1/2" Hubs, Three Close-Up Plugs				
		18	6 Vdc	AC1050-186
		28	6 Vdc	AC1050-286
		18	12 Vdc	AC1050-1812
		28	12 Vdc	AC1050-2812
Long Bracket — Four 1/2" Hubs, Three Close-Up Plugs				
		18	6 Vdc	ALB1050-186
		28	6 Vdc	ALB1050-286
		18	12 Vdc	ALB1050-1812
		28	12 Vdc	ALB1050-2812
Short Bracket — 15 degrees — Two 1/2" Hubs, One Close-Up Plug				
		18	6 Vdc	ASB1050-186
		28	6 Vdc	ASB1050-286
		18	12 Vdc	ASB1050-1812
		28	12 Vdc	ASB1050-2812
Emergency Lighting System Replacement Fixtures — Lamp included — Fits existing mounting hood				
		18	6 Vdc	AAU1N-186
		28	6 Vdc	AAU1N-286
		18	12 Vdc	AAU1N-1812
		28	12 Vdc	AAU1N-2812

① To order fixtures with guard installed, add suffix -G. Reflectors and exit signs are ordered separately. See Accessories page.







ELS Series Emergency Lighting System

Explosionproof, Dust-Ignitionproof

Remote and direct mounted fixtures for hazardous location applications

NEC:

Class I, Division 1 and 2, Groups B ①, C, D
 Class II, Division 1 and 2, Groups E, F, G
 Class III

	Description	Catalog Number
Guard		AAGU-1
Three-Way Exit Sign	 Epoxy enameled steel — 6”-high red lettering Mounts to fixture units in place of guard.	CJEXRN
Single-Sided Exit Sign	 Epoxy enameled steel — 6”-high red lettering Mounts to fixture units in place of guard.	AEXR-15R
30° Angle Reflector		AARW15AN
Standard Dome Reflector		AARW15ST
Push-to-Test Station		<p>Complete Push-to-Test Station EFDCB150J1U1-T-A</p> <p>Cover with Switch and Pilot Light EFKB-J1U1-TEST</p> <p>Switch Only SPBB-U1-Q</p> <p>Pilot Light Only SPLNS-RE-B</p>

① Contact your sales representative for Class I, Group B rating.

ELS Series Emergency Lighting System

Explosionproof, Dust-Ignitionproof

Remote and direct mounted fixtures for hazardous location applications

NEC:

Class I, Division 1 and 2, Groups B ①, C, D
 Class II, Division 1 and 2, Groups E, F, G
 Class III

Weight kg (lb)	Catalog Number	Weight kg (lb)	Catalog Number
23.6 (52.03)	ELS06, ELS012	3.4 (7.50)	AAU1N-186
5.0 (11.02)	AP1050-186-DM	0.2 (0.44)	AAGU1
4.1 (9.04)	AP1050-186	2.3 (5.07)	AEXR-15R
5.7 (12.57)	AC1050-186	2.3 (5.07)	CJEXRN
7.5 (16.53)	ALB1050-186	1.0 (2.20)	AARW15AN
5.7 (12.57)	ASB1050-186	1.0 (2.20)	AARW15ST
1.8 (3.97)	EFDCB150J1U1-T-A		

Dimensions in Millimeters (Inches)

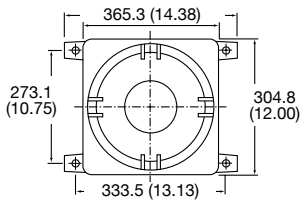

Battery Enclosure

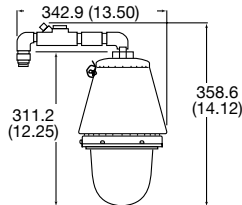

Direct Mount fixture

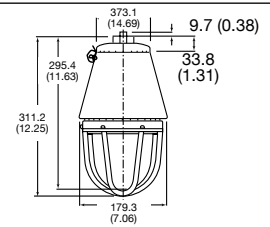

Pendant Mount

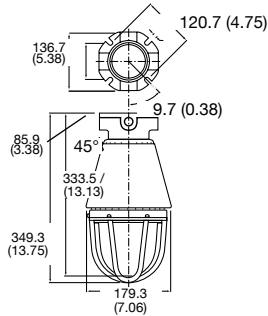

Ceiling Mount

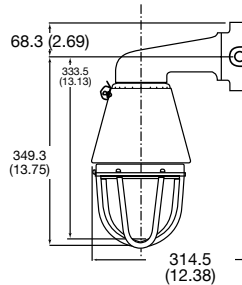

Long Bracket Mount

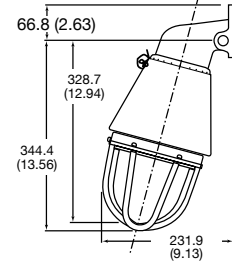

Short Bracket Mount

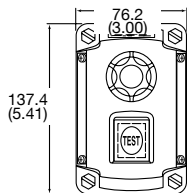

EFDCB150J1JU1-T-A

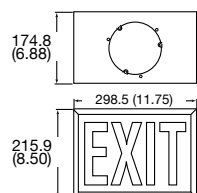

AEXR-15R

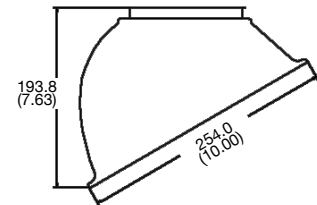

AARW15AN

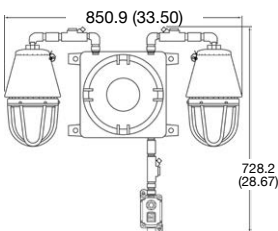

ELS with 2 direct mounted fixtures

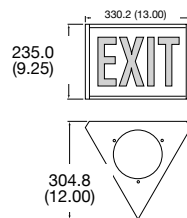

CJEXRN

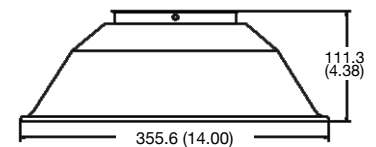

AARW15ST

① Contact your sales representative for Class I, Group B rating.

APL Two and Four Lamp Fluorescent Factory Sealed Luminaires

Explosionproof, Dust-Ignitionproof

120-277 V, 120 V, 277 V, 347 V, 50/60 Hz. For use with Threaded Metal Conduit. Suitable for Wet Locations and Paint Spray Booths.

NEC/CEC:

Class I, Division 1 and 2, Groups C,D

Class II, Division 1 and 2, Groups E,F,G

Class III

Marine Type Electric Fixture Inside Drip-Proof

Type

Applications

- Classified areas where ignitable gases and vapors, dusts, paint residue, paint powder, or corrosive atmospheres may be present, or where excessive moisture is a problem.
- Approved for mounting directly inside a paint spray booth. Complies with NEC 516-3(b) and NFPA No. 33.
- Typical applications include refineries, chemical and petrochemical plants, textile mills, grain elevators and other grain-processing facilities, pharmaceutical plants, and paint spray areas.

Features

- Factory sealed fixture. No external seals needed for classified areas.
- Two lamp:
 - Compact size
 - Uses two single-ended biaxial 40 W fluorescent lamps in a fixture only 29"/736.6 mm long
 - Available for 120-277 V, 50/60 Hz
 - Available for 120 V, 277 V, 347 V, 50/60 Hz ③
- Four lamp:
 - Uses four single-ended biaxial 40 W fluorescent lamps mounted tandem in a 1333.5 mm (52-1/2 in) long fixture
 - Available for 120-277 V, 50/60 Hz
 - Available for 120 V, 277 V, 347 V, 50/60 Hz ③
- Easy to install. Has three 19.1 mm (3/4) in conduit hubs on each end of fixture. Two close-up plugs per end are furnished. Mounts straight down, or at 45° angle to either side. Can be mounted horizontally, or mounted vertically on wall. Gasketed end caps remove easily for wiring or relamping.
- Explosionproof, heat-resistant and impact-resistant glass tubes protect lamps.
- Cool-operating fluorescent lamps provide excellent color rendition and high lumen output per watt. Average lamp life is 20,000 hours. Lamps are furnished.
- Corrosion resistant.
- Reflector (optional) is designed for efficient distribution. Installs and removes using only a screwdriver.
- Appleton APL fixtures are supplied with energy-saving Class P ballasts, equipped with an automatic thermally activated protective device.

Standard Materials

- End housing: copperfree (4/10 of 1% max.) aluminum
- Housing hood and optional reflectors: heavy gauge aluminum
- Wire guard: stainless steel

Standard Finishes

- End housings and hood: two-coat baked gray epoxy finish
- Reflector: white baked powder coat polyester reflecting surface

NEC/CEC Certifications and Compliances

- UL Standard: UL 1598, UL 844
- UL Listed: E10794
- CSA Standard: C22.2 No. 250, C22.2 No. 137
- CSA Certified: 025428



Two Lamp APL



Two Lamp APL with Optional Reflector



Four Lamp APL



Four Lamp APL with Optional Reflector

Illustrated Feature



APL Fixture shown with explosionproof, gasketed end caps removed, allowing access for wiring and relamping.

③ Certified to meet the Canadian Electrical Code (CEC) only.





APL Two and Four Lamp Fluorescent Factory Sealed Luminaires

Explosionproof, Dust-Ignitionproof

120-277 V, 120 V, 277 V, 347 V, 50/60 Hz. For use with Threaded Metal Conduit. Suitable for Wet Locations and Paint Spray Booths.

NEC/CEC:

Class I, Division 1 and 2, Groups C,D
 Class II, Division 1 and 2, Groups E,F,G
 Class III
 Marine Type Electric Fixture Inside Drip-Proof
 Type

	Lamps (Included)	Volts	Hub Size (Inches)	Temperature Rating	Supply Wire °C (°F)	Catalog Number
Luminaires Without Reflector						
	Two Lamp					
	(2) 40 W F40BX	120-277	3/4	T-6	60 (140)	APL240BU
	(2) 40 W F40BX	3477	3/4	T-6	60 (140)	APL240347 ①
	Four Lamp					
	(4) 40 W F40BX	120-277	3/4	T6	60 (140)	APL440BU
	(4) 40W F40BX	347	3/4	T-6	60°C	APL440347 ①
Aluminum reflector with white powder coat polyester finish						
	Two Lamp					APL2R
	Four Lamp					APL4R
Wire Guard						
	Two Lamp — 0.61 m (2') long					APL2GUSS
	Four Lamp — 1.22 m (4') long					ARSGUSS
Exit Sign — 6" red lettering on white enamel field						
	Two Lamp Only					APLEXR

① Certified to meet the Canadian Electrical Code (CEC) only.

APL Two Lamp Factory Sealed Luminaires

Explosionproof, Dust-Ignitionproof

120-277 V, 120 V, 277 V, 347 V, 50/60 Hz. For use with Threaded Metal Conduit. Suitable for Wet Locations and Paint Spray Booths.

NEC/CEC:

Class I, Division 1 and 2, Groups C,D

Class II, Division 1 and 2, Groups E,F,G

Class III

Marine Type Electric Fixture Inside Drip-Proof

Type

Dimensions in Millimeters (Inches)

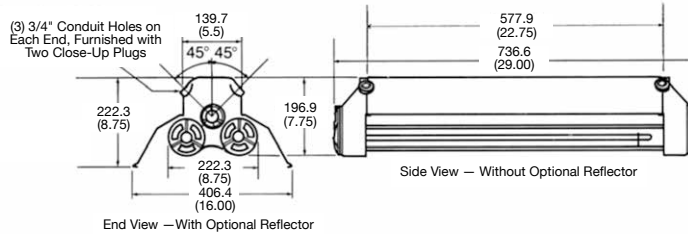

APL240

Photometric Data

Total Luminaire Efficiency = 81.4%

CIE Type – Direct

Plane	Spacing Criteria
0-180	1.28
90-270	1.50
Diagonal	1.54

REPORT NUMBER: APL240R

Lamps: Two 40 W Two-Foot Explosionproof Fluorescent

Coefficients of Utilization – Zonal Cavity Method

Effective Floor Cavity Reflectance 0.20

% Ceiling Rcc	80				70				50				30				10				0					
	70	50	30	10	70	50	30	10	70	50	30	10	70	50	30	10	70	50	30	10	70	50	30	10		
0	97	97	97	97	95	95	95	95	90	90	90	87	87	87	83	83	83	81								
1	88	84	81	77	86	82	79	76	79	76	74	76	73	71	73	71	69	68								
2	80	73	67	62	78	71	66	62	68	64	60	66	62	59	63	60	57	56								
3	72	64	57	51	70	62	56	51	60	54	50	58	53	49	55	51	48	46								
4	66	56	49	43	64	55	48	43	53	47	42	51	46	41	49	45	41	39								
5	61	50	42	37	59	49	42	36	47	41	36	45	40	35	44	39	35	33								
6	56	44	37	32	54	44	37	31	42	36	31	41	35	31	40	34	31	29								
7	52	40	33	28	50	39	33	28	38	32	27	37	31	27	36	31	27	25								
8	48	37	29	24	47	36	29	24	35	29	24	34	28	24	33	28	24	22								
9	45	33	27	22	43	33	26	22	32	26	22	31	26	22	30	25	21	20								
10	42	31	24	20	41	30	24	20	29	24	20	29	23	19	28	23	19	18								

Zonal Lumen Summary

Zone	Lumens	% Lamp	% Fixture	Zone	Lumens	% Lamp	% Fixture
0-30	1234.09	19.6	24.1	90-120	0.00	0.0	0.0
0-40	2086.12	33.1	40.7	90-130	0.00	0.0	0.0
0-60	3955.13	62.8	77.2	90-150	0.00	0.0	0.0
0-90	5125.31	81.4	100.0	90-180	0.00	0.0	0.0
				0-180	5125.32	81.4	100.0

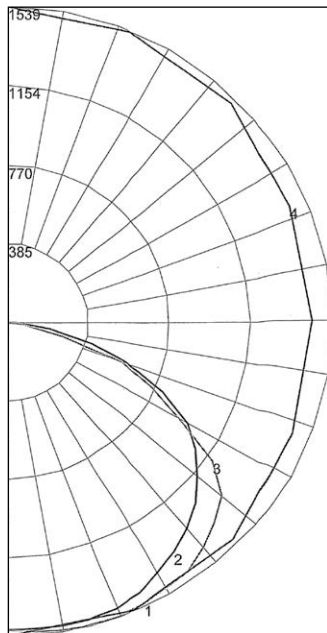

APL Four Lamp Fluorescent Factory Sealed Luminaires

Explosionproof, Dust-Ignitionproof

120-277 V, 120 V, 277 V, 347 V, 50/60 Hz. For use with Threaded Metal Conduit. Suitable for Wet Locations and Paint Spray Booths.

NEC/CEC:

Class I, Division 1 and 2, Groups C,D
 Class II, Division 1 and 2, Groups E,F,G
 Class III
 Marine Type Electric Fixture Inside Drip-Proof
 Type

Photometric Data

Total Luminaire Efficiency = 79.9%

CIE Type – Direct

Plane	Spacing Criteria
0-180	1.30
90-270	1.50
Diagonal	1.54

Zone	Lumens
0-10	277.70
10-20	817.61
20-30	1291.05
30-40	1648.83
40-50	1837.13
50-60	1787.64
60-70	1379.79
70-80	722.47
80-90	148.89
90-100	0.00
100-110	0.00
110-120	0.00
120-130	0.00
130-140	0.00
140-150	0.00
150-160	0.00
160-170	0.00
170-180	0.00

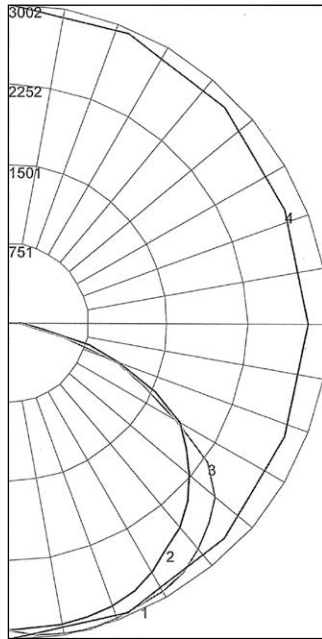

REPORT NUMBER: **APL440R**

Lamps: Four 40 W Explosionproof Fluorescent

Coefficients of Utilization – Zonal Cavity Method

Effective Floor Cavity Reflectance 0.20

% Ceiling Rcc	Effective Floor Cavity Reflectance 0.20																						
	80				70				50				30				10				0		
% Walls Rw	70	50	30	10	70	50	30	10	50	30	10	50	30	10	50	30	10	50	30	10	50	30	10
0	95	95	95	95	93	93	93	93	89	89	89	85	85	85	82	82	82	80	80	80	80	80	80
1	87	83	79	76	85	81	78	75	78	75	73	74	72	70	72	70	68	67	67	67	67	67	67
2	78	72	66	61	76	70	65	61	67	63	59	65	61	58	62	59	56	55	55	55	55	55	55
3	71	62	56	50	69	61	55	50	59	53	49	57	52	48	54	51	47	45	45	45	45	45	45
4	65	55	48	42	63	54	47	42	52	46	41	50	45	41	48	44	40	38	38	38	38	38	38
5	59	49	41	36	58	48	41	36	46	40	35	45	39	35	43	38	35	33	33	33	33	33	33
6	55	44	36	31	53	43	36	31	41	35	31	40	35	30	39	34	30	28	28	28	28	28	28
7	51	39	32	27	49	39	32	27	38	31	27	36	31	27	35	30	26	25	25	25	25	25	25
8	47	36	29	24	46	35	29	24	34	28	24	33	28	24	32	27	24	22	22	22	22	22	22
9	44	33	26	22	43	32	26	21	31	25	21	31	25	21	30	25	21	20	20	20	20	20	20
10	41	30	24	19	40	30	24	19	29	23	19	28	23	19	28	23	19	18	18	18	18	18	18

Zonal Lumen Summary

Zone	Lumens	% Lamp	% Fixture	Zone	Lumens	% Lamp	% Fixture
0-30	2386.36	19.2	24.1	90-120	0.00	0.0	0.0
0-40	4035.19	32.5	40.7	90-130	0.00	0.0	0.0
0-60	7659.96	61.8	77.3	90-150	0.00	0.0	0.0
0-90	9911.11	79.9	100.0	90-180	0.00	0.0	0.0
				0-180	9911.11	79.9	100.0

Dimensions in Millimeters (Inches)

(3) 3/4" Conduit Holes on Each End, Furnished with Two Close-Up Plugs

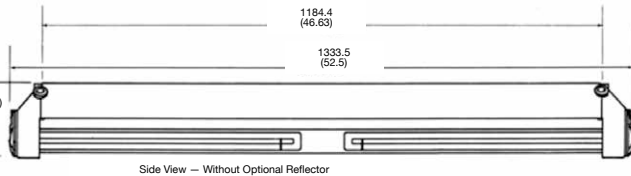
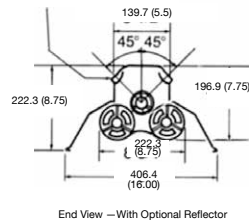

EFU Fluorescent Factory Sealed Luminaires

Explosionproof, Dust-Ignitionproof

UNILETS® for use with Threaded Metal Conduit Suitable for use in Wet Locations

NEC/CEC:

Class I, Division 1 and 2, Groups C, D
Class II, Division 1 and 2, Groups E, F, G
Class III

Applications

- Classified areas such as inside paint spray booths, in pharmaceutical firms, paint-manufacturing plants, printing plants or any location where ignitable dust, fumes, gases, paint residue, paint powder or corrosive atmospheres may be present.

Features

- Factory sealed unit – no external seals required. Installation is easy.
- A wide range of ballasts and voltages are available for both domestic and export applications.
- Three hubs on each end of fixture provide for straight-down mounting or at 45° to either side. Two close-up plugs furnished for each end of fixture.
- Explosionproof, impact-resistant and heat-resistant glass tubes protect lamps.
- Reflectors can easily be removed for replacement or cleaning using only a screwdriver.
- Appleton EFU fixtures are supplied with Class P ballasts, equipped with an automatic thermally activated protective device. They offer protection against excessive voltage, internal ballast short circuiting, inadequate lamp maintenance and improper fixture application.
- Non-sparking exterior surfaces for safer operation.

Standard Materials

- Hood, housings and reflectors: copperfree (4/10 of 1% max.) aluminum
- Hood and housings: gray epoxy finish
- Reflectors: white baked enamel inside and gray epoxy outside

Options

- Emergency battery pack. Suffix -EL.
- Fusing: ARS, AH and AVH fixtures supplied as standard with Class P ballasts with built-in protective device. Additional external fusing available at extra cost. Suffix -F.

NEC/CEC Certifications and Compliances

- UL Standard: UL 1598, UL 844
- UL Listed: E10794
- CSA Standard: C22.2 No. 250, C22.2 No. 137
- CSA Certified: 65182



Explosionproof caps easily removed (shown with caps removed) for easy access. Allows quick wiring or relamping.

EFU Fluorescent Factory Sealed Luminaires

Explosionproof, Dust-Ignitionproof

UNILETS® for use with Threaded Metal Conduit Suitable for use in Wet Locations

NEC/CEC:

Class I, Division 1 and 2, Groups C, D
Class II, Division 1 and 2, Groups E, F, G
Class III

	Lamp	Volts	Hub Size (Inches)	Temperature Rating	Supply Wire °C (°F)	Catalog Number ②
Two Lamps						
	32 W					
	Rapid Start	120-277 V, 50/60 Hz	3/4	T-6	60 (140)	ARS232-BU ①
	T8 Bi-Pin					
	1.22 m (4') 265MA	347 V, 60 Hz	3/4	T-6	60 (140)	ARS232-347 ③①
	40 W					
	Rapid Start	120-277 V, 50/60 Hz	3/4	T-6	60 (140)	ARS240-BU ①
	T12 Bi-Pin					
	1.22 m (4') 430MA	347 V, 60 Hz	3/4	T-6	60 (140)	ARS240-347 ③①
	60 W					
	Rapid Start High Output	120-277 V, 50/60 Hz	3/4	T-6	60 (140)	AH260-BU
T-12 Recessed Double Contact						
1.22 m (4') 800MA	347 V, 60 Hz	3/4	T-6	60 (140)	AH260-347 ③	
110 W						
Rapid Start VHO-SHO	120 V, 60 Hz	3/4	T-6	60 (140)	AVH210-118	
T-12 Recessed Double Contact	277 V, 60 Hz	3/4	T-6	60 (140)	AVH210-277	
1.22 m (4') 1500MA	347 V, 60 Hz	3/4	T-6	60 (140)	AVH210-347 ③	
Three Lamps						
	32 W					
	Rapid Start	120-277 V, 50/60 Hz	3/4	T-6	60 (140)	ARS332-BU ①
	T8 Bi-Pin					
	1.22 m (4') 265MA	347 V, 60 Hz	3/4	T-6	60 (140)	ARS332-347 ③①
	40 W					
	Rapid Start	120-277 V, 50/60 Hz	3/4	T-6	60 (140)	ARS340-BU
	T12 Bi-Pin					
	1.22 m (4') 430MA	347 V, 60 Hz	3/4	T-6	60 (140)	ARS340-347 ③
	60 W					
	Rapid Start High Output	120-277 V, 50/60 Hz	3/4	T-6	60 (140)	AH360-BU
T-12 Recessed Double Contact						
1.22 m (4') 800MA	347 V, 60 Hz	3/4	T-6	60 (140)	AH360-347 ③	
Four Lamps						
	32 W					
	Rapid Start	120-277 V, 50/60 Hz	3/4	T-6	60 (140)	ARS432-BU ①
	T8 Bi-Pin					
	1.22 m (4') 265MA	347 V, 60 Hz	3/4	T-6	60 (140)	ARS432-347 ③①
	40 W					
	Rapid Start	120-277 V, 50/60 Hz	3/4	T-6	60 (140)	ARS440-BU
	T12 Bi-Pin					
	1.22 m (4') 430MA	347 V, 60 Hz	3/4	T-6	60 (140)	ARS440-347 ③
	60 W					
	Rapid Start High Output	120-277 V, 50/60 Hz	3/4	T-6	60 (140)	AH460-BU
T-12 Recessed Double Contact						
1.22 m (4') 800MA	347 V, 60 Hz	3/4	T-6	60 (140)	AH460-347 ③	
110 W						
Rapid Start Very High Output	120 V, 60 Hz	3/4	T-6	60 (140)	AVH410-118	
T-12 Recessed Double Contact	277 V, 60 Hz	3/4	T-6	60 (140)	AVH410-277	
1.22 m (4') 1500MA	347 V, 60 Hz	3/4	T-6	60 (140)	AVH410-347 ③	
Protector for two-lamp fluorescent fixture						
	Fits two lamp 1.22 m (4') fixtures only (ARS, AH and AVH series) UV stabilized polycarbonate					EFP248
	Wire guard— use 1 piece for 2 lamp fixtures, 2 pieces for 4 lamp fixtures (not available for 3 lamp fixtures)					ARSGUSS

NOTE: In paint spray areas, solvents and thinners may "cloud" the polycarbonate. Light transmission characteristics may be reduced.

① For Emergency Battery Pack, add suffix -EL.

② Fluorescent lamps are not included. Supplied with automatic resetting dual protected "Class P" ballast. For additional external fusing, add suffix -F.

③ Certified to meet the Canadian Electrical Code (CEC) only.

Visit our website at www.emerson.com or contact us at (800) 621-1506.

© May 2016

519

EMERSON

Appleton®

FLUORESCENT/AREA: NEC/CEC EXPLOSIONPROOF

EFU Fluorescent Factory Sealed Luminaires

Explosionproof, Dust-Ignitionproof

UNILETS® for use with Threaded Metal Conduit Suitable for use in Wet Locations

NEC/CEC:

Class I, Division 1 and 2, Groups C, D
 Class II, Division 1 and 2, Groups E, F, G
 Class III

Lamps	Hz	Voltage	Operating Amps	Input Watts	Starting Temperature °C (°F)	Catalog Number
32 W Rapid Start T-8 Bi-Pin 48" 265 mA						
2	50/60	120-277	.52-.22	62-60	-18 (0)	ARS232-BU
2	60	347	.20	59	-18 (0)	ARS232-347 ①
3	50/60	120-277	.78-.33	93-93	-18 (0)	ARS332-BU
3	60	347	.30	86	-18 (0)	ARS332-347 ①
4	50/60	120-277	1.03-.43	124-120	-18 (0)	ARS432-BU
4	60	347	.40	118	-18 (0)	ARS432-347 ①
40 W Rapid Start T-12 Bi-Pin 48" 430 mA						
2	50/60	120-277	.70-.35	84-42	10 (50)	ARS240-BU
2	60	347	.30	96	10 (50)	ARS240-347 ①
3	50/60	120-277	.99-.45	114	10 (50)	ARS340-BU
3	60	347	.50	140	10 (50)	ARS340-347 ①
4	50/60	120-277	1.40-.70	168-84	10 (50)	ARS440-BU
4	60	347	.60	192	10 (50)	ARS440-347 ①
60 W Rapid Start High Output T-12 Bi-Pin 48" 800 mA						
2	50/60	120-277	1.05-.55	122-86	-29 (-20)	AH260-BU
2	60	347	.50	145	-29 (-20)	AH260-347 ①
3	50/60	120-277	1.54-.66	182	-29 (-20)	AH360-BU
3	60	347	.90	256	-29 (-20)	AH360-347 ①
4	50/60	120-277	2.10-1.10	244-172	-29 (-20)	AH460-BU
4	60	347	1.00	290	-29 (-20)	AH460-347 ①
110 W Rapid Start VHO-SHO T-12 Bi-Pin 48" 1500 mA						
2	60	120	2.60	300	-29 (-20)	AVH210-118
2	60	277	.98	250	-29 (-20)	AVH210-277
2	60	347	.90	250	-29 (-20)	AVH210-347 ①
4	60	120	5.20	600	-29 (-20)	AVH410-118
4	60	277	1.96	500	-29 (-20)	AVH410-277
4	60	347	1.80	500	-29 (-20)	AVH410-347 ①

Dimensions in Millimeters (Inches)

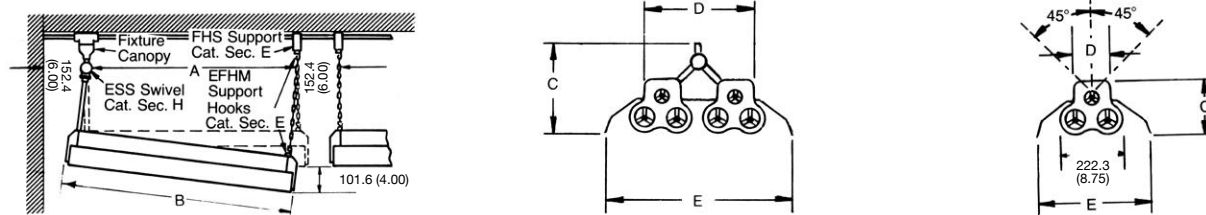

No. of Lamps	A	B	C	D	E
2	1184.4 (46.63)	1332.0 (52.44)	222.3 (8.75)	139.7 (5.50)	381.0 (15.00)
3	1184.4 (46.63)	1332.0 (52.44)	222.3 (8.75)	139.7 (5.50)	489.0 (19.25)
4	1184.4 (46.63)	1332.0 (52.44)	290.6 (11.44)	355.6 (14.00)	596.9 (23.50)

① Certified to meet the Canadian Electrical Code (CEC) only.

EFU Fluorescent Factory Sealed Luminaires

Explosionproof, Dust-Ignitionproof

* Data is based on F32 TB Rapid Start Lamps. For other lamps use the following multipliers: 60 W Cool White – 1.50; and 110 W VHO – 2.19. Candlepower distribution curves and other coefficients of utilization tables are available on request.

NEC/CEC:

Class I, Division 1 and 2, Groups C, D
Class II, Division 1 and 2, Groups E, F, G
Class III

Photometric Data

Zone Lumens Total Luminaire Efficiency = 78.6%

Zone	Lumens	CIE Type – Direct			
		Plane	Spacing Criteria		
0-10	139.50	0-180	1.28		
10-20	402.70	90-270	1.36		
20-30	620.06	Diagonal	1.44		
30-40	767.75				
40-50	821.07				
50-60	776.93				
60-70	597.35				
70-80	299.18				
80-90	57.43				
90-100	0.00				
100-110	0.00				
110-120	0.00				
120-130	0.00				
130-140	0.00				
140-150	0.00				
150-160	0.00				
160-170	0.00				
170-180	0.00				

Zonal Lumen Summary				
Zone	Lumens	% Lamp	% Fixture	
0-30	1162.26	20.4	25.9	
0-40	1930.01	33.9	43.1	
0-60	3528.01	61.9	78.7	
0-90	4481.97	78.6	100.0	
90-120	0.00	0.0	0.0	
90-130	0.00	0.0	0.0	
90-150	0.00	0.0	0.0	
90-180	0.00	0.0	0.0	
0-180	4481.97	78.6	100.0	

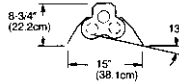
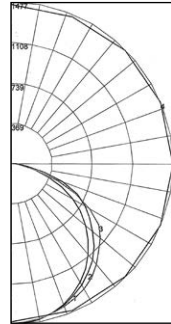

REPORT NUMBER: **ARS232**

Lamps: Two 32 W Explosionproof Fluorescent with Reflector *

Coefficients of Utilization – Zonal Cavity Method

Effective Floor Cavity Reflectance 0.20

% Ceiling Rcc	% Walls	Rw	80				70				50				30				10				0
			70	50	30	10	70	50	30	10	50	30	10	50	30	10	50	30	10				
0	94	94	94	94	91	91	91	91	87	87	87	84	84	84	80	80	80	79	0				
1	86	82	78	75	83	80	77	74	77	74	72	74	72	70	71	69	68	66	0				
2	78	71	66	61	76	70	65	60	67	63	59	64	61	58	62	59	56	55	0				
3	71	62	56	51	69	61	55	50	59	53	49	56	52	48	54	51	47	46	0				
4	65	55	48	43	63	54	47	42	52	46	42	50	45	41	48	44	41	39	0				
5	59	49	42	36	58	48	41	36	46	40	36	45	40	35	43	39	35	33	0				
6	55	44	37	32	53	43	36	32	42	36	31	40	35	31	39	34	31	29	0				
7	51	40	33	28	49	39	32	28	38	32	28	37	31	27	36	31	27	25	0				
8	47	36	29	25	46	36	29	25	35	29	24	34	28	24	33	28	24	23	0				
9	44	33	27	22	43	33	26	22	32	26	22	31	26	22	30	25	22	20	0				
10	41	31	24	20	40	30	24	20	29	24	20	29	23	20	28	23	20	18	0				

Zone Lumens Total Luminaire Efficiency = 96.8%

Zone	Lumens	CIE Type – Direct			
		Plane	Spacing Criteria		
0-10	249.94	0-180	1.26		
10-20	726.14	90-270	1.38		
20-30	1122.12	Diagonal	1.46		
30-40	1392.92				
40-50	1496.9				
50-60	1397.8				
60-70	1087.36				
70-80	557.01				
80-90	103.54				
90-100	0.00				
100-110	0.00				
110-120	0.00				
120-130	0.00				
130-140	0.00				
140-150	0.00				
150-160	0.00				
160-170	0.00				
170-180	0.00				

Zonal Lumen Summary				
Zone	Lumens	% Lamp	% Fixture	
0-30	2098.20	25.0	25.8	
0-40	3491.12	41.6	42.9	
0-60	6385.81	76.0	78.5	
0-90	8133.73	96.8	100.0	
90-120	0.00	0.0	0.0	
90-130	0.00	0.0	0.0	
90-150	0.00	0.0	0.0	
90-180	0.00	0.0	0.0	
0-180	8133.73	96.8	100.0	

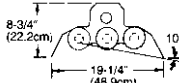
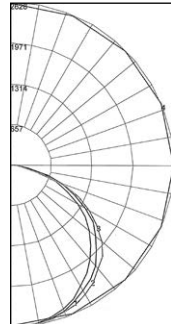

REPORT NUMBER: **ARS332**

Lamps: Three 32 W Explosionproof Fluorescent with Reflector *

Coefficients of Utilization – Zonal Cavity Method

Effective Floor Cavity Reflectance 0.20

% Ceiling Rcc	% Walls	Rw	80				70				50				30				10				0
			70	50	30	10	70	50	30	10	50	30	10	50	30	10	50	30	10				
0	115	115	115	115	113	113	113	113	108	108	108	103	103	103	99	99	99	97	0				
1	105	101	97	93	103	99	95	91	94	91	88	91	88	86	87	85	83	81	0				
2	96	87	81	75	93	86	80	74	82	77	73	79	75	71	76	72	69	67	0				
3	87	77	69	62	84	75	68	62	72	66	60	69	64	59	67	62	58	56	0				
4	79	68	59	52	77	66	58	52	64	57	51	62	55	50	59	54	50	48	0				
5	73	60	51	45	71	59	51	45	57	50	44	55	49	44	53	48	43	41	0				
6	67	54	45	39	65	53	45	39	51	44	38	50	43	38	48	42	38	36	0				
7	62	49	40	34	60	49	40	34	47	39	34	45	38	34	44	38	33	31	0				
8	58	44	36	30	56	44	36	30	42	35	30	41	35	30	40	34	30	28	0				
9	54	41	33	27	53	40	32	27	39	32	27	38	31	27	37	31	27	25	0				
10	50	38	30	25	49	37	30	25	36	29	24	35	29	24	34	28	24	22	0				

Zone Lumens Total Luminaire Efficiency = 70.9%

Zone	Lumens	CIE Type – Direct			
		Plane	Spacing Criteria		
0-10	237.58	0-180	1.28		
10-20	692.75	90-270	1.42		
20-30	1081.02	Diagonal	1.48		
30-40	1352.75				
40-50	1467.39				
50-60	1408.53				
60-70	1130.45				
70-80	598.78				
80-90	117.42				
90-100	0.00				
100-110	0.00				
110-120	0.00				
120-130	0.00				
130-140	0.00				
140-150	0.00				
150-160	0.00				
160-170	0.00				
170-180	0.00				

Zonal Lumen Summary				
Zone	Lumens	% Lamp	% Fixture	
0-30	2011.34	17.6	24.9	
0-40	3364.10	29.5	41.6	
0-60	6240.02	54.7	77.2	
0-90	8086.66	70.9	100.0	
90-120	0.00	0.0	0.0	
90-130	0.00	0.0	0.0	
90-150	0.00	0.0	0.0	
90-180	0.00	0.0	0.0	
0-180	8086.66	70.9	100.0	

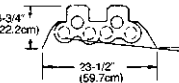
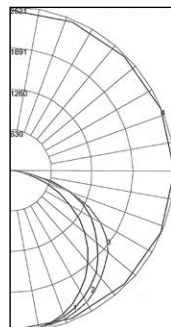

REPORT NUMBER: **ARS432**

Lamps: Four 32 W Explosionproof Fluorescent with Reflector *

Coefficients of Utilization – Zonal Cavity Method

Effective Floor Cavity Reflectance 0.20

% Ceiling Rcc	% Walls	Rw	80				70				50				30				10				0
			70	50	30	10	70	50	30	10	50	30	10	50	30	10	50	30	10				
0	84	84	84	84	82	82	82	82	79	79	79	75	75	75	72	72	72	71	0				
1	77	74	70	68	75	72	69	67	69	67	64	66	64	62	64	62	61	59	0				
2	70	64	59	55	68	62	58	54	60	56	53	57	54	51	55	53	50	49	0				
3	63	56	50	45	62	54	49	44	52	48	44	50	46	43	48	45	42	41	0				
4	58	49	43	38	56	48	42	37	46	41	37	45	40	36	43	39	36	34	0				
5	53	44	37	32	51	43	37	32	41	36	32	40	35	31	38	34	31	29	0				
6	49	39	33	28	47	38	32	28	37	32	27	36	31	27	35	30	27	25	0				
7	45	35	29	24	44	35	29	24	34	28	24	33	28	24	32	27	24	22	0				
8	42	32	26	22	41	32	26	22	31	25	21	30	25	21	29	24	21	20	0				
9	39	29	23	19	38	29	23	19	28	23	19	27	23										

PAPL Portable Two and Four Lamp Factory Sealed Fluorescent Luminaire

Explosionproof, Dust-Ignitionproof

120 V. Suitable for Wet Locations and Paint Spray Booths. UL Listed for Horizontal use only.

NEC/CEC:

Class I, Division 1 and 2, Groups C, D

Applications

- Classified areas where ignitable gases and vapors, dusts, paint residue, paint powder, or corrosive atmospheres may be present, or where excessive moisture is a problem.
- Approved for using directly inside a paint-spray booth. Complies with NEC 516-3(c) and NFPA No. 33.
- Typical applications include aircraft manufacturing and maintenance facilities, refineries, chemical and petrochemical plants, textile mills, grain elevators and other grain-processing facilities, pharmaceutical plants, paint-spray areas, and where the permanent mounting of a fixture is not practical.
- UL approved for horizontal use only.

Features

- Factory sealed fixture. No external seals needed for classified areas.
- Compact size. Uses two or four single-ended biaxial 40 W fluorescent lamps in a portable fixture. (2 lamp cart overall length is 978 mm (38-1/2 in), 4 lamp cart overall length is 1575 mm (62 in)).
- Gasketed end caps remove easily for wiring and relamping.
- Teflon-coated stainless steel wire guard supplied standard.
- Adjustable aluminum mounting frame allows fixtures to pivot at 45° increments in a 180° horizontal plane.
- 50' of 16-3 SOW cord with nonmetallic explosionproof plug prewired for 120 V.
- Static discharge wheels.
- Explosionproof, heat-resistant and impact-resistant glass tubes help protect the lamp.
- Cool-operating fluorescent lamps provide excellent color rendition and high lumen output per watt. Average lamp life is 20,000 hours.
- Corrosion resistant.
- Reflectors (optional) are designed for efficient distribution. Easily installed using only a screwdriver.
- Energy-saving Class P ballasts, with automatic thermally activated protective device.
- Fixture uses Appleton's ECP1523 Plug, which is UL Classified for use with Killark® UGR and Crouse-Hinds® ENR series receptacles, as well as Appleton's U-Line receptacles.

Standard Materials

- End housing, cord grip and elbow: copperfree (4/10 of 1% max.) aluminum
- Housing hood, frame and optional reflectors: heavy gauge aluminum
- Wheels: static discharge rubber
- Guard: Teflon coated stainless steel
- Plug: aluminum

Standard Finishes

- End housings and hood: two-coat baked gray epoxy finish
- Reflector: white baked powder coat polyester
- Frame assembly: natural aluminum

NEC/CEC Certifications and Compliances

- UL Standard: UL 1598, UL 844
- UL Listed: E59147
- CSA Standard: C22.2 No. 12, C22.2 No. 137
- cUL Listed: E59147

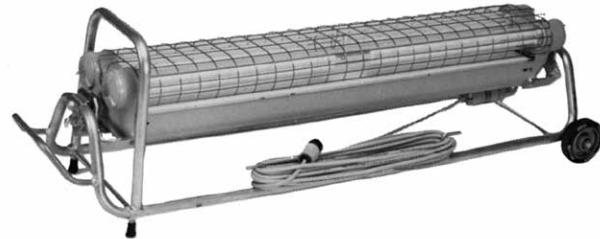

4-Lamp Luminaire

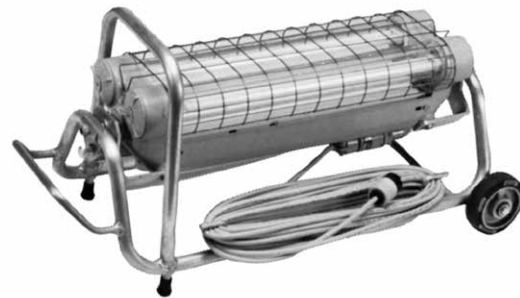

2-Lamp Luminaire

PAPL Portable Two and Four Lamp Factory Sealed Fluorescent Luminaire

Explosionproof, Dust-Ignitionproof

120 V. Suitable for Wet Locations and Paint Spray Booths. UL Listed for Horizontal use only.

NEC/CEC:
Class I, Division 1 and 2, Groups C, D

	Lamps Included	Volts	Temperature Rating	Catalog Number
 <p>Two-Lamp Luminaire Illustrated</p>	Two-Lamp Luminaires Less Reflector			
	(2) 40 W F40BX	120	T6	PAPL240-120
	Reflector Only			
	Aluminum reflector with white powder coat polyester finish			
				APL2R
	Four-Lamp Luminaires Less Reflector			
	(4) 40 W F40BX	120	T6	PAPL440-120
	Reflector Only			
	Aluminum reflector with white powder coat polyester finish			
				APL4R

Dimensions in Millimeters (Inches)

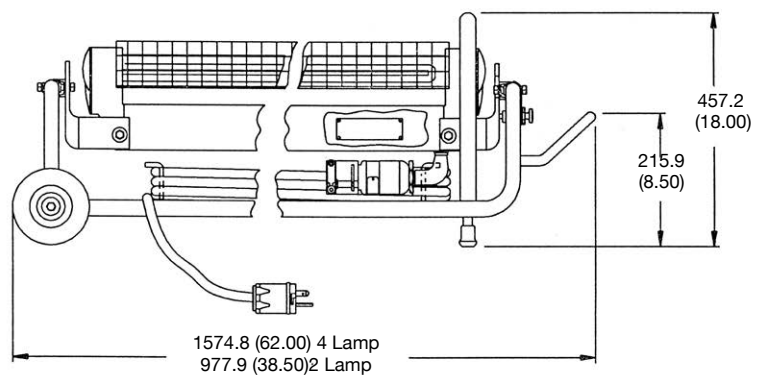
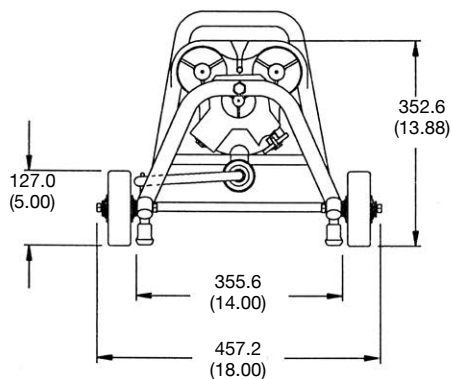

Appleton®

FLUORESCENT/AREA: NEC/CEC EXPLOSIONPROOF

ATX™ FL Series Light Duty Nonmetallic Fluorescent Luminaires

Standard and Emergency Back-Up. Zone 2 and 22

ATEX:
Zone 2 and 22
Ⓜ II 3 GD
ATEX - IEC IP65/67

FLUORESCENT/AREA: ATEX/IECEx STANDARD AND EMERGENCY BACK-UP

Applications

- Light duty luminaire ideal for commercial and light industrial locations including hazardous areas designated as Zone 2 or 22 environments.
- Typical applications include oil refineries petrochemical plants, pulp and paper mills, tunnels and other light duty manufacturing locations.



2 x 58 W

Features

- Utilizes two 26 mm (T8) bi-pin fluorescent lamps.
- Fiberglass reinforced polyester housing.
- Instant start 95% power factor ballast.
- Available in various lengths and wattages ranging from 18 to 58. Pre-impregnated fiberglass reinforced white polyester housing.
- Closing system using stainless steel clips.
- Electrostatically applied white powder painted steel reflector provides optimal lighting distribution.
- Poured-in-place elastomer gasket secures IP65/67 ingress protection.



2 x 18 W

Standard Material

- Fiberglass reinforced polyester (FRP) housing
- Polycarbonate lens
- White powder painted sheet steel reflector
- Elastomer gasket
- Polycarbonate lampholders
- Mounting accessories available in different materials such as gray painted aluminum, zinc plated steel, galvanized steel or 316 stainless steel

Options

- Available in 3 hours emergency version, including multi-tap ballast with built-in monthly self test. Test results through multi-colored LED.
- Plug-in battery pack is easy to remove for maintenance.
- Battery voltage is 6 volts and 4 Ah capacity.
- One fluorescent tube remains lit for up to 3 hours and up to 29% light intensity for 18 Watt, 15% for 36 Watt and 9% for 58 Watt.
- All emergency units supplied with cut off switch to battery when fixture is opened.

ATEX Certifications and Compliances

- Certification Type: EFn (Standard Version) / EFn-EM (Emergency Version)
- Gas: Zone 2
 - Conforming to ATEX 94/9/CE: Ⓜ II 3 G
 - ATEX/IEC Protection: Ex nR II or Ex nA II
 - T Rating: T4 for nA protection mode. (T3 for 2x58W Version)

See temperature chart for nR protection mode

- Dust: Zone 22
 - Conforming to ATEX 94/9/CE: Ⓜ II 3 D
 - Type of Protection: Ex tD A22
 - Surface Temperature: (See table)
- Ambient Temperature: -20 °C to +55 °C (-4 °F to +131 °F)
- CE Declaration of Conformity: 50213/50219
- ATEX Certificate EFn (Standard Version): LCIE 08.6005X
- ATEX Certificate EFn-EM (Emergency Version): LCIE 08.6063X
- Index of Protection (solid and liquid): IP65 / 67

EURASEC Certification

- EURASEC N° TC RU C-FR.Г505.B.00912

ATX™ FL Series Light Duty Nonmetallic Fluorescent Luminaires

Standard and Emergency Back-Up. Zone 2 and 22

ATEX:
 Zone 2 and 22
 II 3 GD
 ATEX - IEC IP65/67

Order using catalog numbering guide below or select catalog number from tables on following pages.

Catalog Numbering Guide For FL Non-Metallic Fluorescent Lighting Fixtures

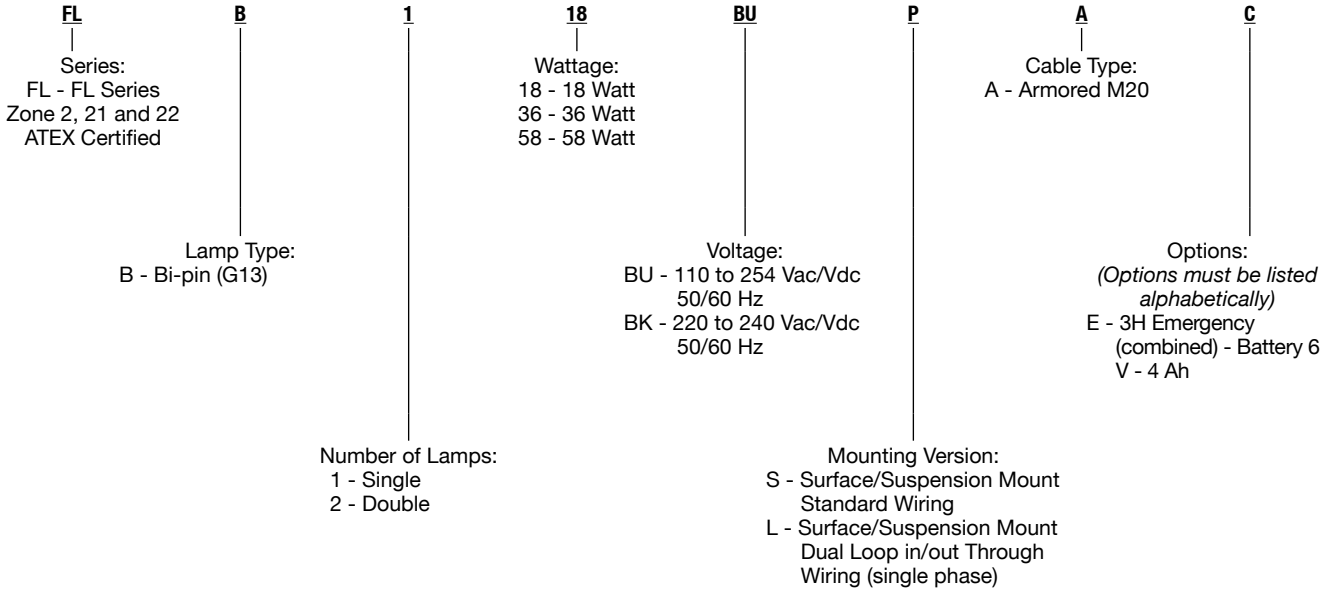

Temperature Chart

Version	Dust Surface Temperature	T Rating for Ta = 40° C (104° F)	Gas T Rating for Ta = 50° C (122° F)	T Rating for Ta = 55° C (131° F)
1 x 18 W	75°C (167°F)	T6	T6	T6
2 x 18 W		T6	T5	T5
1 x 36 W	83°C (181°F)	T6	T6	T5
2 x 36 W		T6	T6	T5
1 x 58 W	91°C (196°F)	T5	T5	T5
2 x 58 W		T5	T5	T5

ATX™ FL Series Light Duty Nonmetallic Fluorescent Luminaires

Standard and Emergency Back-Up. Zone 2 and 22

ATEX:
Zone 2 and 22
II 3 GD
ATEX - IEC IP65/67

FLUORESCENT/AREA: ATEX/IECex STANDARD AND EMERGENCY BACK-UP

Standard Version for Armored and Unarmored Cable

Supplied with one M20 cable entry at each end plus two locknuts, two earth continuity and one blanking plug.
Also supplied with one 2 x 3 x 2.5 mm² (0.004 x 0.003 in²) max. flexible or rigid connection terminal block.

Number of Lamps	Watts	Voltage (V)	Weight kg (lbs)	Volume dm ³ (in ³)	Pack.	Catalog Number
1	18	220/240	2.3 (5.07)	22.3 (1360.83)	1	FLB118BKSA
2	18	220/240	2.3 (5.07)	22.3 (1360.83)	1	FLB218BKSA
2	18	110/254	2.3 (5.07)	22.3 (1360.83)	1	FLB218BUSA
1	36	220/240	2.8 (6.17)	38.0 (2318.90)	1	FLB136BKSA
1	36	110/254	2.8 (6.17)	38.0 (2318.90)	1	FLB136BUSA
2	36	220/240	3.6 (7.94)	38.0 (2318.90)	1	FLB236BKSA
2	36	110/254	3.6 (7.94)	38.0 (2318.90)	1	FLB236BUSA
1	58	220/240	3.4 (7.50)	45.0 (2746.07)	1	FLB158BKSA
1	58	110/254	3.4 (7.50)	45.0 (2746.07)	1	FLB158BUSA
2	58	220/240	4.4 (9.70)	45.0 (2746.07)	1	FLB258BKSA
2	58	110/254	4.4 (9.70)	45.0 (2746.07)	1	FLB258BUSA

Emergency Version for Armored and Unarmored Cable





Supplied with one M20 entries with earth continuity at each end. Also supplied with two M20 locknuts and one blanking plug.
Equipped with one 2 x (5 x 2.5 mm² / 0.008 x 0.003 in²) max. flexible or rigid connection terminal block

Number of Lamps	Watts	Voltage (V)	Weight kg (lbs)	Volume dm ³ (in ³)	Pack.	Catalog Number
2	18	110/254	4.5 (9.92)	22.3 (1360.83)	1	FLB218BUSAE
2	36	110/254	7.0 (15.4)	38.0 (2318.90)	1	FLB236BUSAE
2	58	110/254	7.5 (16.53)	45.0 (2746.07)	1	FLB258BUSAE

ATX™ FL Series Light Duty Nonmetallic Fluorescent Luminaires

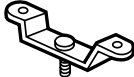
Standard and Emergency Back-Up. Zone 2 and 22

ATEX:
 Zone 2 and 22
 II 3 GD
 ATEX - IEC IP65/67

	Description	Pack	Catalog Number
Fixing Brackets			
	Set of two brackets for surface installation		
	Zinc plated steel	1	FEFBZ
	316 stainless steel	1	FEFBS
Brackets for Surface Mounting			
	Set of two		
	Aluminum (gray painted)	1	FESBA
	316 stainless steel	1	FESBS
M8 Ring Bolts			
	Set of two		
	Zinc plated steel	1	FERBM8Z
Half Clamps Brackets for Pole Mounting			
	Set of two		
	Dia. 42 to 49 mm (1.65 to 1.93 in) pole (31.8 to 38.1 mm (1.25 to 1.5 in) tube)		
	Zinc plated steel	1	FEHC49Z
	316 stainless steel	1	FEHC49S
	Dia. 60 mm (2.36 in) pole (50.8mm (2 in) tube)		
	Zinc plated steel	1	FEHC60Z
	316 stainless steel	1	FEHC60S
Hinged Brackets			
	Set of two brackets for adjusting luminaire		
	Aluminum	1	FEHBA
	316 stainless steel	1	FEHBS
Fall Prevention Kit			
	1.20 M stainless steel chain	1	FDSCS

FLUORESCENT / AREA: ATEX / IECX STANDARD AND EMERGENCY BACK-UP

Appleton®

ATX™ FL Series Light Duty Nonmetallic Fluorescent Luminaires

Standard and Emergency Back-Up. Zone 2 and 22

ATEX:
 Zone 2 and 22
 II 3 GD
 ATEX - IEC IP65/67

FLUORESCENT/AREA: ATEX/IECEx STANDARD AND EMERGENCY BACK-UP

Emergency Function Diagram — Emergency Function 2 Tubes

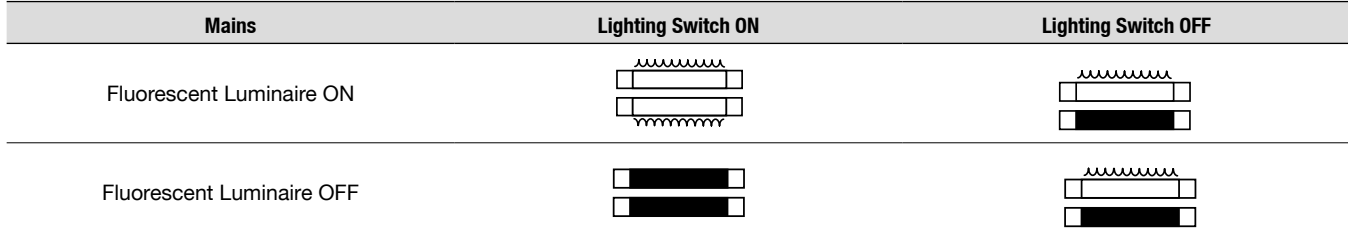

Photometric Data

Polar curves for a 1000 lm flux, according to NF C 71-120
 Luminaire symbol according to NF C 71-121

--- Longitudinal
 — Transverse

1 x 18 W
 Efficiency 67.8%
 NF C 71-121: 0.58 H + 0.09 T

2 x 18 W
 Efficiency 68.9%
 NF C 71-121: 0.60 H + 0.09 T

	CANDELA DISTRIBUTION	
	0-180	90-270
0	142	142
5	142	142
10	139	140
15	135	135
20	130	132
25	123	128
30	113	126
35	102	128
40	90	132
45	78	136
50	66	134
55	54	131
60	43	129
65	33	119
70	23	110

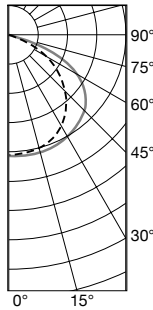

	CANDELA DISTRIBUTION	
	0-180	90-270
0	116	116
5	115	119
10	113	133
15	110	150
20	105	156
25	100	157
30	94	158
35	88	159
40	81	158
45	74	157
50	65	152
55	55	145
60	45	137
65	35	128
70	25	114

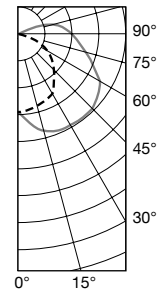

2 x 36 W
 Efficiency 64.1%
 NF C 71-121: 0.57 H + 0.07 T

2 x 58 W
 Efficiency 63.6%
 NF C 71-121: 0.56 H + 0.07 T

	CANDELA DISTRIBUTION	
	0-180	90-270
0	163	163
5	162	162
10	160	159
15	155	145
20	149	140
25	142	139
30	132	139
35	120	138
40	104	134
45	80	133
50	60	129
55	50	125
60	40	120
65	31	108
70	23	95

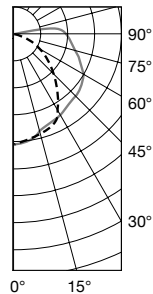

	CANDELA DISTRIBUTION	
	0-180	90-270
0	160	160
5	159	160
10	157	157
15	153	146
20	148	140
25	141	139
30	132	139
35	121	138
40	107	134
45	85	132
50	68	127
55	56	122
60	45	117
65	35	107
70	24	90

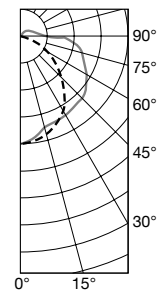

ATX™ FN Series Heavy Duty Nonmetallic Fluorescent Luminaires

Standard and Emergency Back-Up. Zone 2 - 21 and 22

ATEX/IECEX:
Zone 2 - 21 and 22
II 3 GD and II 2 D
IP66/67 - IK10

Applications

- Can be installed in hazardous areas designated as Zone 2, 21 and 22.
- For use in locations where a high degree of corrosion resistance is required.
- For indoor/outdoor use where protection against dirt, water and moisture is necessary.
- Typical applications include oil refineries, petrochemical facilities, pulp and paper mills, food processing plants, warehouses, underground tunnels and general manufacturing facilities.

Features

- Corrosion-resistant fiberglass reinforced polyester body and hinged polycarbonate lens.
- High impact resistance housing (20 Joules - IK10) from -40°C to +55 °C (-40° F to +131 °F) ambient temperature and wind profile for use in extreme offshore and onshore environments.
- Latch assembly and elastomer gasket seals against water and dust ingress, IP66/67.
- Easily accessed for maintenance using Allen key or straight blade screw driver.
- Central opening with unique patented release system to prevent damage.
- Hinged parabolic reflector for high lumen output efficiency.
- Vibration resistant spring loaded lampholders for Bi-pin (G13) or mono-pin (Fa6) versions.
- Electronic multi-tap ballast 110 to 254 Vac/Vdc +/- 10% 50/60 Hz, for global applications. High power factor electronic ballast (>0.95). EOL (End Of Life) protection in accordance to the latest EN/IEC 60079-7 standard.
- Also available with electronic ballast 220/240 Vac/Vdc +/- 10% 50/60 Hz. High power factor electronic ballast (>0.95). EOL.
- Available in 3 hours emergency version, including multi-tap ballast with built-in monthly self test. Test results through multi-color LED.

Standard Material

- Fiberglass reinforced polyester housing
- Polycarbonate lens
- Elastomer gasket
- Highly reflective white polycarbonate internal reflector
- Mounting accessories available in different materials such as gray painted aluminum, zinc plated steel, galvanized steel or 316 stainless steel

Options

- Silicone coating for added protection in H₂S hydrogen sulfide environments.
- Without safety switch.
- Level gauge light fitting.
- 316 stainless steel fixing inserts.



2 x 58 W



2 x 36 W



2 x 18 W

ATEX/IECEX Certifications and Compliances

- Certification Type: FLn
 - Gas: Zone 2
 - Conforming to ATEX 94/9/CE: Ⓢ II 3 G
 - Type of Protection 'nA' : Ex nA IIC T6 Gc
 - Type of Protection 'nR' : Ex nR IIC T4 Gc
 - T-Rating: T6 (nA) or T4 (nR)
 - Ambient Temperature: -20 °C to +55 °C (-4 °F to +131 °F) ①
 - Dust: Zone 21
 - Conforming to ATEX 94/9/CE: Ⓢ II 2 D
 - Type of Protection: Ex tD A21
 - Surface Temperature: T75 °C (T167 °F)
 - Ambient Temperature: -40 °C to +55 °C (-40 °F to +131 °F) ①
 - Dust: Zone 22
 - Conforming to ATEX 94/9/CE: II 3 D
 - Type of Protection: Ex t IIIC Dc
 - Surface Temperature: T75 °C (T167 °F)
- Ambient Temperature: -20 °C to +55 °C (-40 °F to +131 °F) ①
- CE Declaration of Conformity: 50212
- ATEX Certificate Zone 2-22: LCIE 03 ATEX 6072
- ATEX Certificate Zone 21: LCIE 02 ATEX 6067
- IECEx Certificate Zone 2-22: IECEx LCI 04.0021
- Index of Protection according EN/IEC 60529: IP66/67
- Impact Resistance (shock): IK10

EURASEC Certification

- EURASEC N° TC RU C-FR.Г505.B.00912

Other Certification

- INMETRO Certificate: BVC11.0815 ①

① Inmetro certification available on special request only. Contact your local sales representative for more information.

ATX™ FN Series Heavy Duty Nonmetallic Fluorescent Luminaires

Standard and Emergency Back-Up. Zone 2 - 21 and 22

ATEX/IECEX:
 Zone 2 - 21 and 22
 II 3 GD and II 2 D
 IP66/67 - IK10

FLUORESCENT/AREA: ATEX/IECEX STANDARD AND EMERGENCY BACK-UP

Order using catalog numbering guide below or select catalog number from tables on following pages.

Catalog Numbering Guide For FN Non-Metallic Fluorescent Lighting Fixtures

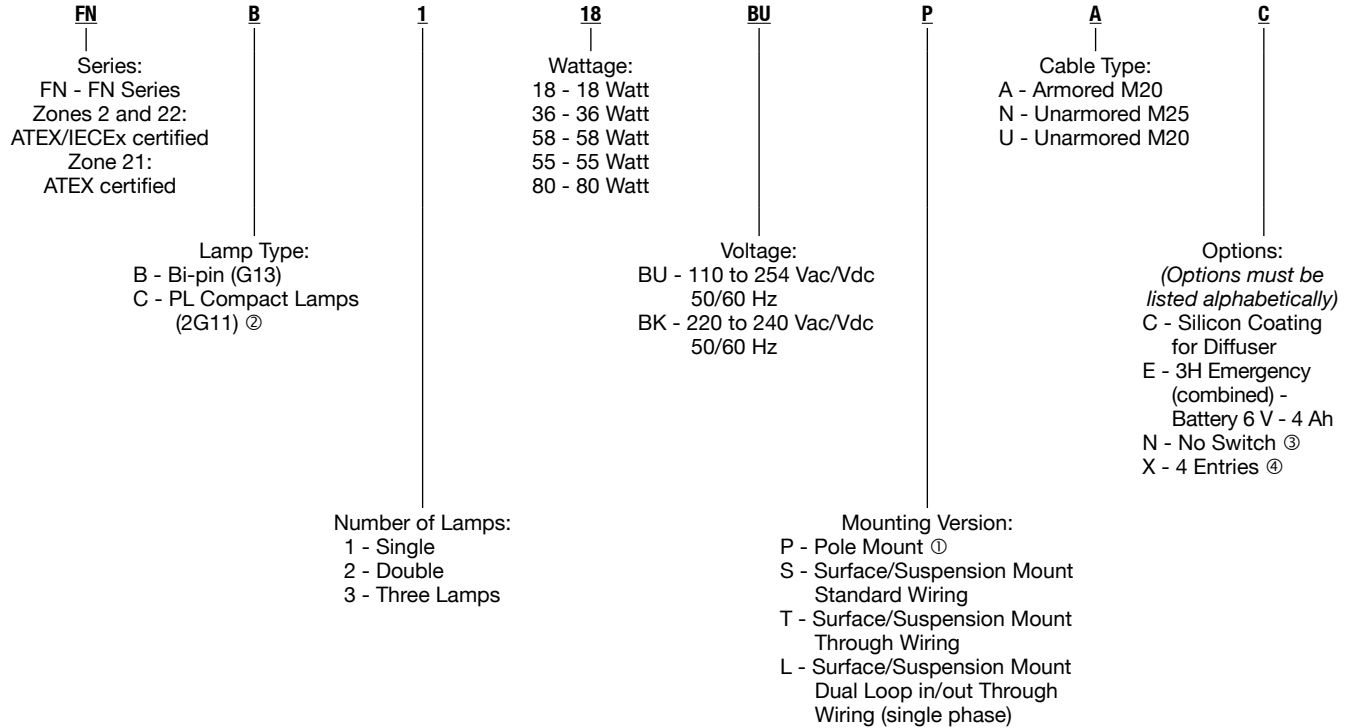

① Only 2 x 18 W and 2 x 36 W with M25 entry versions.
 ② Only 55 W and 80 W standard versions.
 ③ Only for standard versions.
 ④ Only for S, T and L mounting versions.

ATX™ FN Series Heavy Duty Nonmetallic Fluorescent Luminaires

Standard and Emergency Back-Up. Zone 2 - 21 and 22

ATEX/IECEX:
Zone 2 - 21 and 22
II 3 GD and II 2 D
IP66/67 - IK10

Standard Version

Surface/Suspension Mounting and Standard Wiring Version

Connection via 1 x 6 terminals.

Capacity (flexible/solid): 4 mm²/6 mm² 0.006 in²/0.009 in².

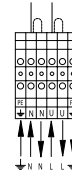
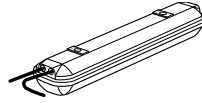

Unarmored Version - Bi-pin (G13)

Three M25 threaded entries, two at one end and one at opposite end, supplied with one

M25 polyamide cable gland (dia. 8 to 18.5 mm (0.31 to 0.73 in)) and two M25 polyamide blanking plugs.

Number of Lamps	Power (W)	Lamp Type	Voltage (V)	Weight kg (lb)	Volume dm ³ (in ³)	Catalog Number
2	18	G13	220/240	5.5 °C (12.13 °F)	32.3 (1971.07)	FNB218BKSNN
2	18	G13	110/254	5.5 °C (12.13 °F)	32.3 (1971.07)	FNB218BUSNN
2	36	G13	220/240	7.9 °C (17.42 °F)	54.2 (3307.49)	FNB236BKSNN
2	36	G13	110/254	7.9 °C (17.42 °F)	54.2 (3307.49)	FNB236BUSNN
2	58	G13	220/240	9 °C (19.84 °F)	65 (3966.54)	FNB258BKSNN
2	58	G13	110/254	11 °C (24.25 °F)	65 (3966.54)	FNB258BUSNN

Armored Version - Bi-pin (G13)

Two M20 threaded entries with brass earth continuity plate at one end and one M20 plugged clearance entry, supplied with two M20 polyamide plugs.

Number of Lamps	Power (W)	Lamp Type	Voltage (V)	Weight kg (lb)	Volume dm ³ (in ³)	Catalog Number
2	18	G13	220/240	5.5 °C (12.13 °F)	32.3 (1971.07)	FNB218BKSAN
2	18	G13	110/254	5.5 °C (12.13 °F)	32.3 (1971.07)	FNB218BUSAN
2	36	G13	220/240	7.9 °C (17.42 °F)	54.2 (3307.49)	FNB236BKSAN
2	36	G13	110/254	7.9 °C (17.42 °F)	54.2 (3307.49)	FNB236BUSAN
2	58	G13	220/240	9 °C (19.84 °F)	65 (3966.54)	FNB258BKSAN
2	58	G13	110/254	11 °C (24.25 °F)	65 (3966.54)	FNB258BUSAN

Emergency Version

Surface/Suspension Mounting and Standard Wiring

Connection via 1 x 4 terminals for 18 W version.

Connection via 1 x 8 terminals for 36 W and 58 W versions.

Capacity (flexible/solid): 4 mm²/6 mm².

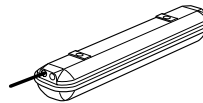

18 W

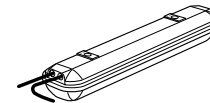

36/58 W

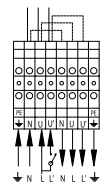

Unarmored Version - Bi-pin (G13)

Three M25 entries, two at one end and one at opposite end, supplied with one M25

polyamide cable gland (dia. 8 to 18.5 mm (0.31 to 0.73 in)) and two M25 polyamide blanking plugs.

Number of Lamps	Power (W)	Lamp Type	Voltage (V)	Weight kg (lb)	Volume dm ³ (in ³)	Duration (Hours)	Battery Capacity	Catalog Number
2	18	G13	110/254	7.3 °C (16.09 °F)	32.3 (1971.07)	3 H	4 Ah	FNB218BUSNEN
2	36	G13	110/254	9.6 °C (21.16 °F)	54.2 (3307.49)	3 H	4 Ah	FNB236BUSNEN
2	58	G13	110/254	10.7 °C (23.59 °F)	65 (3966.54)	3 H	4 Ah	FNB258BUSNEN

Armored Version - Bi-pin (G13)

Two M20 threaded entries with brass earth continuity plate at one end and

one M20 plugged clearance entry, supplied with two M20 polyamide plugs.

Number of Lamps	Power (W)	Lamp Type	Voltage (V)	Weight kg (lb)	Volume dm ³ (in ³)	Duration (Hours)	Battery Capacity	Catalog Number
2	18	G13	110/254	7.3 °C (16.09 °F)	32.3 (1971.07)	3 H	4 Ah	FNB218BUSAEN
2	36	G13	110/254	9.6 °C (21.16 °F)	54.2 (3307.49)	3 H	4 Ah	FNB236BUSAEN
2	58	G13	110/254	10.7 °C (23.59 °F)	65 (3966.54)	3 H	4 Ah	FNB258BUSAEN





ATX™ FN Series Heavy Duty Nonmetallic Fluorescent Luminaires

Standard and Emergency Back-Up. Zone 2 - 21 and 22

ATEX/IECEX:
Zone 2 - 21 and 22
II 3 GD and II 2 D
IP66/67 - IK10

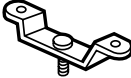
FLUORESCENT/AREA: ATEX/IECEX STANDARD AND EMERGENCY BACK-UP

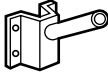
Appleton®

	Description	Pack	Catalog Number
Fixing Brackets			
	Set of two brackets for surface installation		
	Zinc plated steel	1	FEFBZ
	316 stainless steel	1	FEFBS
Brackets for Surface Mounting			
	Set of two		
	Aluminum (gray painted)	1	FESBA
	316 stainless steel	1	FESBS
M8 Ring Bolts			
	Set of two		
	Zinc plated steel	1	FERBM8Z
Half Clamps Brackets for Pole Mounting			
	Set of two		
	Dia. 42 to 49 mm (1.65 to 1.93") pole [31.8 to 38.1 mm (1.25 to 1.5 in) tube]		
	Zinc plated steel	1	FEHC49Z
	316 stainless steel	1	FEHC49S
	Dia. 2.36"/60 mm pole (50.8mm (2 in) tube)		
	Zinc plated steel	1	FEHC60Z
	316 stainless steel	1	FEHC60S
Wall Mounting Adaptor			
	For pole mounting version (dia. 42 mm (1.65 in))		
	Galvanized steel	1	FEWMG
Hinged Brackets			
	Set of two brackets for adjusting luminaire		
	Aluminum	1	FEHBA
	316 stainless steel	1	FEHBS

ATX™ FN Series Heavy Duty Nonmetallic Fluorescent Luminaires

Standard and Emergency Back-Up. Zone 2 - 21 and 22

ATEX/IECEX:
Zone 2 - 21 and 22
II 3 GD and II 2 D
IP66/67 - IK10

Wiring Diagram

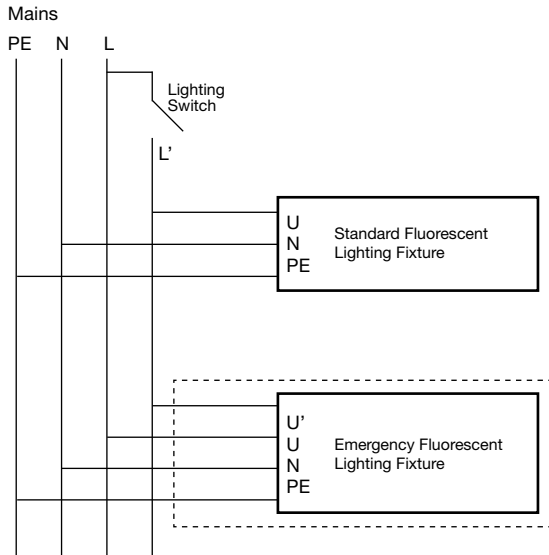

Emergency Function Diagram

Two Lamp Version

Mains	Lighting Switch ON	Lighting Switch OFF
ON		
OFF		

Three Lamp Version

Mains	Lighting Switch ON	Lighting Switch OFF
ON		
OFF		

LED Status

Color	Indication	Function
Green	LED glows	Batteries are connected
	LED blinks	Batteries are charged
Red	LED blinks	Batteries are not connected or defect
Yellow	LED blinks	Batteries are charging and discharging during automatic cycle

Dimensions in Millimeters (Inches)

Surface/Suspension Mounting

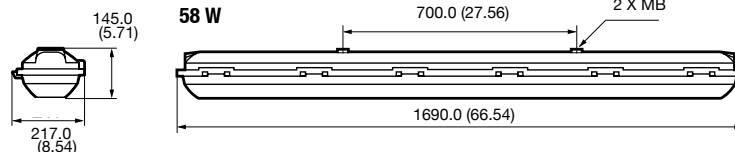
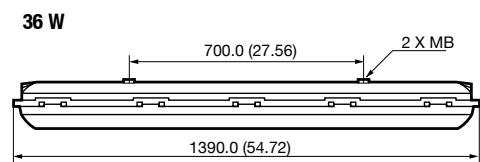
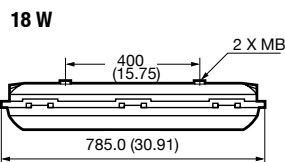

ATX™ FN Series Heavy Duty Nonmetallic Fluorescent Luminaires

Standard and Emergency Back-Up. Zone 2 - 21 and 22

ATEX/IECEX:
 Zone 2 - 21 and 22
 II 3 GD and II 2 D
 IP66/67 - IK10

FLUORESCENT/AREA: ATEX/IECEX STANDARD AND EMERGENCY BACK-UP

Photometric Data

Polar curves for a 1000 lm flux, according to NF C 71-120
 Luminaire symbol according to NF C 71-121

--- Longitudinal
 — Transverse

2 x 18 W
 Efficiency 85.1%
 NF C 71-121: 0.78 H + 0.08 T

CANDELA DISTRIBUTION

	0-180	90-270
0	195	195
5	195	194
10	192	192
15	187	192
20	181	193
25	173	194
30	163	194
35	152	193
40	138	192
45	124	191
50	108	182
55	91	176
60	73	163
65	55	150
70	37	145

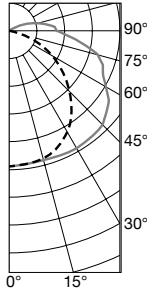

2 x 36 W
 Efficiency 80.5%
 NF C 71-121: 0.73 H + 0.07 T

CANDELA DISTRIBUTION

	0-180	90-270
0	185	185
5	185	184
10	182	182
15	178	181
20	172	183
25	164	183
30	154	183
35	143	183
40	131	183
45	117	179
50	102	173
55	85	166
60	68	155
65	51	145
70	35	141

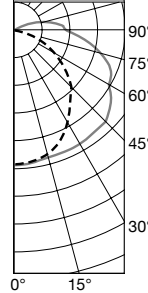

2 x 58 W
 Efficiency 76.9%
 NF C 71-121: 0.70 H + 0.07 T

CANDELA DISTRIBUTION

	0-180	90-270
0	173	173
5	172	173
10	170	171
15	166	169
20	161	172
25	154	172
30	145	172
35	135	171
40	123	172
45	111	170
50	97	165
55	82	157
60	66	148
65	50	139
70	34	133

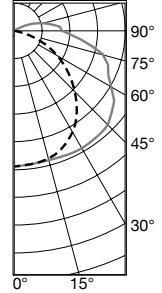

ATX™ RE Series Recessed and Surface Mounting Fluorescent Luminaires

Standard and Emergency Back-Up. Increased Safety

ATEX/IECEX:
Zone 1 and 2 - 21 and 22
Ⓜ II 2 GD
IP66 - IK09/10

Applications

- Designed for flush or surface mounting; most specifically clean room environments where a seamless smooth ceiling is mandatory.
- Typical applications include: the food industry, chemical plants, pharmaceuticals and delicate electronic manufacturing such as the aerospace industry.
- Ideal for use in rigorous corrosive environments, involving water, dust and extreme temperature variations.
- Can be installed in hazardous areas designated as Zone 1 and 2 – 21 and 22.

Features

- One piece welded steel housing with integral frame to seal out contaminants.
- Allows recessed mounting in permanent ceilings from 55 mm to 130 mm (2.17 to 5.12 in).
- Frameless tempered 5 mm (1/4 in) thick lens. Lens secured to housing by internal metallic hinges and secured with captive 316L stainless steel screws, allowing for easy lamp replacement and fixture maintenance.
- Positive safety switch and Ex e battery with plug-in connector for safety and easy maintenance in hazardous locations.
- Designed for ease of installation and maintenance.
- Bi-pin G13 lampholder.
- Also available as surface mounting version.
- New ballast:
 - EOL (End Of Life) protection in accordance to the latest EN 60079-7 standard
 - Multi-tap 110 to 254 Vac/Vdc +/-10% 50/60 Hz
 - Two channel standard ballast (if one lamp fails the second lamp remains in operation)
 - Ex e plug-in connector for rapid and error free maintenance
 - Self test on 3 hours duration emergency version
 - High power factor electronic ballast (>0.95)
- Cable entries:
 - Three clearance holes for M20 cable gland supplied with M20 polyamide cable gland — cable diameter 6.5 to 14.5 mm (0.26 to 0.57 in) — and M20 polyamide blanking plug. See *Standard Cable Entry Accessories on following pages.*
 - One M6 earth stud.

Standard Materials

- Housing and integral frame: one piece, welded steel
- Safety lens: 5 mm (0.20 in) thick tempered
- Gasket: silicone, 4 lips, completely sealed and contained in the fixture
- Internal reflector: white polycarbonate multi-parabolic
- Cable gland and blanking plug: polyamide

Standard Finishes

- Housing and integral frame: white powder epoxy paint

Options

- 3 hours emergency version - Battery 6 V - 4 Ah. Add suffix **-E**.
- 1 hour 30 emergency (combined) - Battery 6 V - 7 Ah. Add suffix **-E1**.
- 3H Emergency (combined) - Battery 6 V - 7 Ah. . Add suffix **-E7**.
- Without safety switch. Add suffix **-N**.
- White painted steel internal reflector. Add suffix **-P**.
- 316L stainless steel housing and integral frame, natural finish. Add suffix **-S**.



4 x 18 W Surface Mounting



2 x 36 W Recessed

ATEX/IECEX Certifications and Compliances

- Certification Type: RE
 - Gas: Zones 1 and 2
 - Conforming to ATEX 94/9/CE: Ⓜ II 2 G
 - Type of Protection: Ex de IIC/ Ex demb IIC (emergency version)
 - T-Rating: T6 to T4 (See *Table on following page*)
- Dust: Zone 22
 - Conforming to ATEX 94/9/CE: Ⓜ II 2 D
 - Type of Protection: Ex tD A21
 - Surface Temperature: T75 °C (T165 °F)
- Ambient Temperature: -20 °C ≤ Ta ≤ +55 °C (-4 °F ≤ Ta ≤ +131 °F)
- CE Declaration of Conformity: 50276
- ATEX Certificate: LCIE 07 ATEX 6104
- IECEx Certificate: IECEx LCI 07.0019
- Index of Protection according EN/IEC 60529: IP66
- Impact Resistance (shock): IK09 or IK10 depending on version

EURASEC Certification

- EURASEC N° TC RU C-FR.Г505.B.00912

Other Certification

- INMETRO Certificate: BVC13.2672 ①

① Inmetro certification available on special request only. Contact your local sales representative for more information.

ATX™ RE Series Recessed and Surface Mounting Fluorescent Luminaires

Standard and Emergency Back-Up. Increased Safety

ATEX/IECEX:
 Zone 1 and 2 - 21 and 22
 II 2 GD
 IP66 - IK09/10

FLUORESCENT/AREA: ATEX/IECEX STANDARD AND EMERGENCY BACK-UP

Order using catalog numbering guide below or select catalog number from tables on following pages.

Catalog Numbering Guide — RE Series Recessed Fluorescent Luminaires

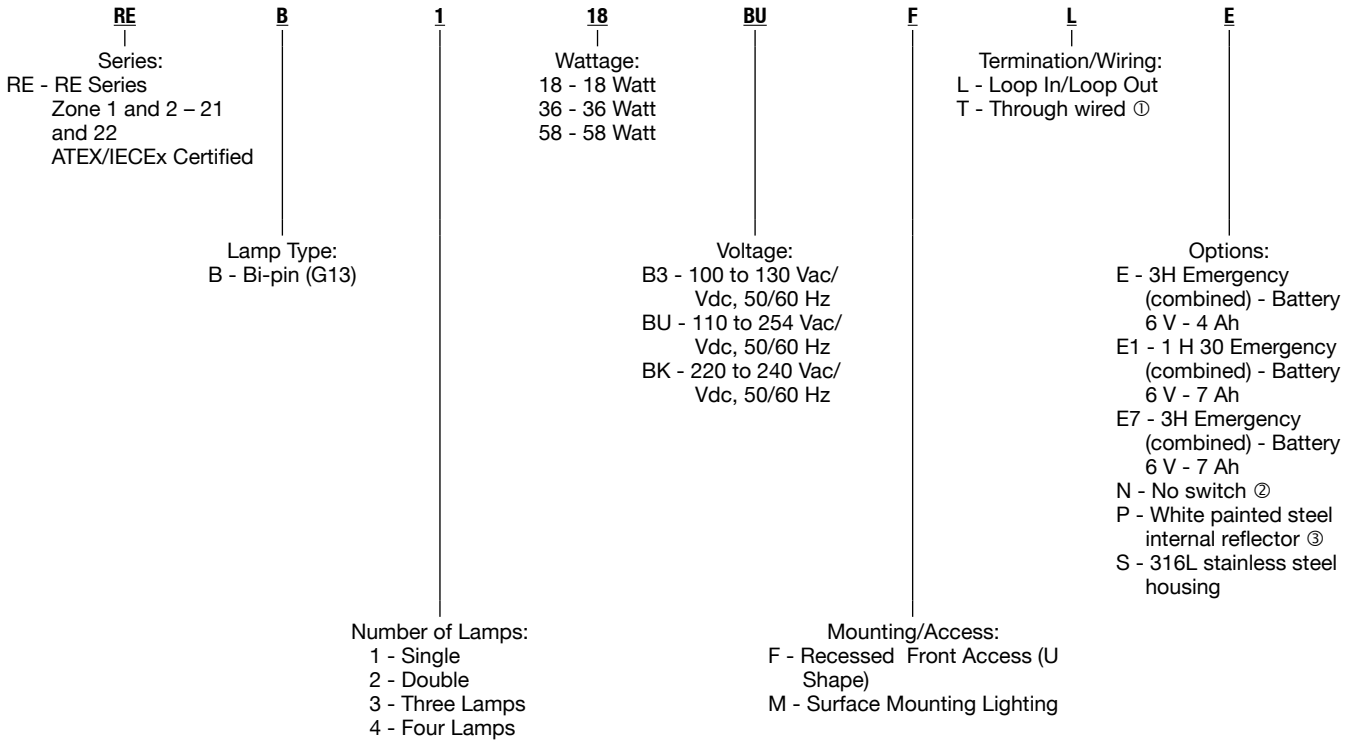

① T/W and Loop in/Loop out - 3 cores (single phase).
 ② Only for standard versions.
 ③ As standard for 18 W emergency version and 4 lamp version.

ATX™ RE Series Recessed and Surface Mounting Fluorescent Luminaires

Standard and Emergency Back-Up. Increased Safety

ATEX/IECEX:
 Zone 1 and 2 - 21 and 22
 II 2 GD
 IP66 - IK09/10

T Ratings

Version	Ambient Temperature					
	Ceiling Position			Wall Position		
	40 °C (104 °F)	50 °C (122 °F)	55 °C (131 °F)	40 °C (104 °F)	50 °C (122 °F)	55 °C (131 °F)
2 x 18 W ①	T6	T5	T5	T5	T5	T4
2 x 18 W Emergency ①	T5	T4	T4	T5	T5	T4
3 x 18 W	T5	T4	T4	T4	T4	T4
4 x 18 W	T5	T4	T4	T5	T4	T4
2 x 36 W ①	T5	T4	T4	T5	T4	T4
2 x 36 W Emergency ①	T5	T4	T4	T5	T4	T4
3 x 36 W	T4	T4	T4	T4	T4	T4
4 x 36 W	T5	T4	T4	T5	T4	T4
2 x 58 W ①	T4	T4	T4	T4	T4	T4
2 x 58 W Emergency ①	T4	T4	T4	T4	T4	T4
3 x 58 W	T4	T4	T4	T4	T4	T4
4 x 58 W	T4	T4	T4	T4	T4	T4

Termination and Wiring

- Terminal capacity: 4 mm² (0.006 in²) flexible or 6 mm² (0.009 in²) solid.
- Loop in/Loop out: One terminal block ②
 - Standard version:
2 (L) + 2 (N) + 2 (PE)
 - Emergency version:
2 (LP) + 2 (L) + 2 (N) + 2 (PE)
- Through wired: Two terminal blocks (one at each end) ②
 - Standard version:
2 (L) + 2 (N) + 2 (PE)
1 (L) + 1 (N) + 1 (PE)
 - Emergency version:
2 (LP) + 2 (L) + 2 (N) + 2 (PE)
1 (LP) + 1 (L) + 1 (N) + 1 (PE)

Standard Cable Entry Accessories

Version	Cable Gland	Blanking Plug	Nickel Plated Brass Locknut
Loop	1	1	3
Through	2	1	3

① T Rating for single lamp version is the same as twin lamp version.
 ② PE: Earth; N: Neutral. L: Live. LP: Permanent Live for emergency version.

ATX™ RE Series Recessed and Surface Mounting Fluorescent Luminaires

Standard and Emergency Back-Up. Increased Safety

ATEX/IECEX:
 Zone 1 and 2 - 21 and 22
 II 2 GD
 IP66 - IK09/10

FLUORESCENT/AREA: ATEX/IECEX STANDARD AND EMERGENCY BACK-UP

Recessed — 110/254 Vac/Vdc, 50/60 Hz — Front Access — White Painted Steel Housing



Version	Reflector	Wiring	Weight kg (lb)	Volume dm ³ (in ³)	Catalog Number ①②③④⑤⑥⑦
Standard Version — Bi-pin Lamps (G13)					
2 x 18 W	Polycarbonate	Loop	14 (30.86)	64 (3905.52)	REB218BUFL
		Through	14 (30.86)	64 (3905.52)	REB218BUFT
4 x 18 W	White Painted Steel	Loop	21 (46.30)	93 (5675.21)	REB418BUFLP
		Through	21 (46.30)	93 (5675.21)	REB418BUFTP
2 x 36 W	Polycarbonate	Loop	19 (41.89)	108 (6590.56)	REB236BUFL
		Through	19 (41.89)	108 (6590.56)	REB236BUFT
4 x 36 W	White Painted Steel	Loop	29 (63.93)	158 (9641.75)	REB436BUFLP
		Through	29 (63.93)	158 (9641.75)	REB436BUFTP
2 x 58 W	Polycarbonate	Loop	22 (48.50)	130 (7933.09)	REB258BUFL
		Through	22 (48.50)	130 (7933.09)	REB258BUFT
4 x 58 W	White Painted Steel	Loop	32 (70.55)	190 (11594.51)	REB458BUFLP
		Through	32 (70.55)	190 (11594.51)	REB458BUFTP
3 Hours Emergency Version — Bi-pin Lamps (G13)					
2 x 18 W	Polycarbonate	Loop	14 (30.86)	64 (3905.52)	REB218BUFLEP
		Through	14 (30.86)	64 (3905.52)	REB218BUFTPEP
4 x 18 W	White Painted Steel	Loop	21 (46.30)	93 (5675.21)	REB418BUFLEP
		Through	21 (46.30)	93 (5675.21)	REB418BUFTPEP
2 x 36 W	Polycarbonate	Loop	19 (41.89)	108 (6590.56)	REB236BUFLE
		Through	19 (41.89)	108 (6590.56)	REB236BUFTE
4 x 36 W	White Painted Steel	Loop	29 (63.93)	158 (9641.75)	REB436BUFLEP
		Through	29 (63.93)	158 (9641.75)	REB436BUFTPEP
2 x 58 W	Polycarbonate	Loop	22 (48.50)	130 (7933.09)	REB258BUFLE
		Through	22 (48.50)	130 (7933.09)	REB258BUFTE
4 x 58 W	White Painted Steel	Loop	32 (70.55)	190 (11594.51)	REB458BUFLEP
		Through	32 (70.55)	190 (11594.51)	REB458BUFTPEP

- ① For surface mounting lighting, replace letter **F** with letter **M** in the 9th position; example: REB218BUML.
- ② For 3 hours emergency version - Battery 6 V - 4 Ah, add suffix **E** to the end of the catalog number; example: REB218BUFLE.
- ③ For 1 hour 30 emergency (combined) - Battery 6 V - 7 Ah, add suffix **E1** to the end of the catalog number; example: REB218BUFLE1.
- ④ For 3H Emergency (combined) - Battery 6 V - 7 Ah, add suffix **E7** to the end of the catalog number; example: REB218BUFLE7.
- ⑤ For fixture without a safety switch, add suffix **N** to the end of the catalog number; example: REB218BUFLN.
- ⑥ For fixture with a white painted steel internal reflector, add suffix **P** to the end of the catalog number; example: REB218BUFLP.
- ⑦ For fixture with 316L stainless steel housing and integral frame and natural finish, add suffix **S** to the end of the catalog number; example: REB218BUFLS.

ATX™ RE Series Recessed and Surface Mounting Fluorescent Luminaires

Standard and Emergency Back-Up. Increased Safety

ATEX/IECEX:
 Zone 1 and 2 - 21 and 22
 II 2 GD
 IP66 - IK09/10

Accessories and Replacement Parts			
	Description	Weight kg (lb)	Catalog Number
Fixing Brackets - Set of four			
	Zinc plated steel	0.60 (1.32)	REFBST
	316 stainless steel	0.60 (1.32)	REFBSS
Ceiling Mounting Brackets - Set of two			
	Zinc plated steel	2.00 (4.41)	RECMST
	316 stainless steel	2.00 (4.41)	RECMSS
M8 Eye Bolts - Set of four			
	Zinc plated steel	0.25 (0.55)	REEBST
	316 stainless steel	0.25 (0.55)	REEBSS

FLUORESCENT / AREA: ATEX / IECEX STANDARD AND EMERGENCY BACK-UP

 **Appleton**

ATX™ RE Series Recessed and Surface Mounting Fluorescent Luminaires

Standard and Emergency Back-Up. Increased Safety

ATEX/IECEX:
 Zone 1 and 2 - 21 and 22
 II 2 GD
 IP66 - IK09/10

FLUORESCENT/AREA: ATEX/IECEX STANDARD AND EMERGENCY BACK-UP

Wiring Diagram

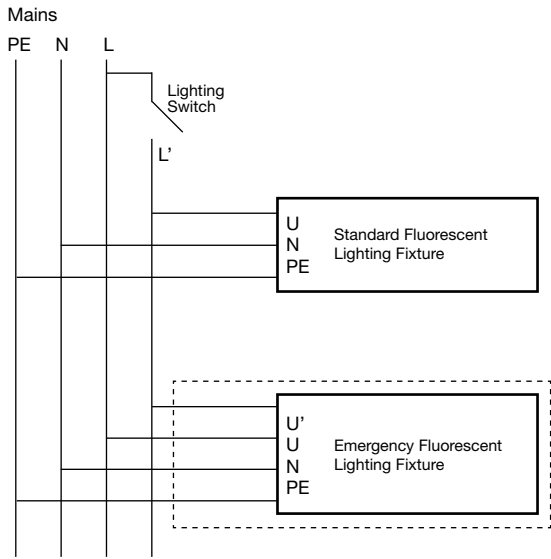

Emergency Function Diagram

Two Lamp Version

Mains	Lighting Switch ON	Lighting Switch OFF
ON		
OFF		

Three Lamp Version

Mains	Lighting Switch ON	Lighting Switch OFF
ON		
OFF		

LED Status

Color	Indication	Function
Green	LED glows	Batteries are connected
	LED blinks	Batteries are charged
Red	LED blinks	Batteries are not connected or defect
Yellow	LED blinks	Batteries are charging and discharging during automatic cycle

Emergency Light Duration

Version	Battery Capacity	Duration	Light Output
2 x 18 W	4 Ah – 6 V	3 hours	45%
2 x 36 W	4 Ah – 6 V	3 hours	15%
	7 Ah – 6 V	3 hours	25%
2 x 58 W	4 Ah – 6 V	3 hours	9%
	7 Ah – 6 V	3 hours	15%

ATX™ RE Series Recessed and Surface Mounting Fluorescent Luminaires

Standard and Emergency Back-Up. Increased Safety

ATEX/IECEX:
 Zone 1 and 2 - 21 and 22
 II 2 GD
 IP66 - IK09/10

Dimensions in Millimeters (Inches)

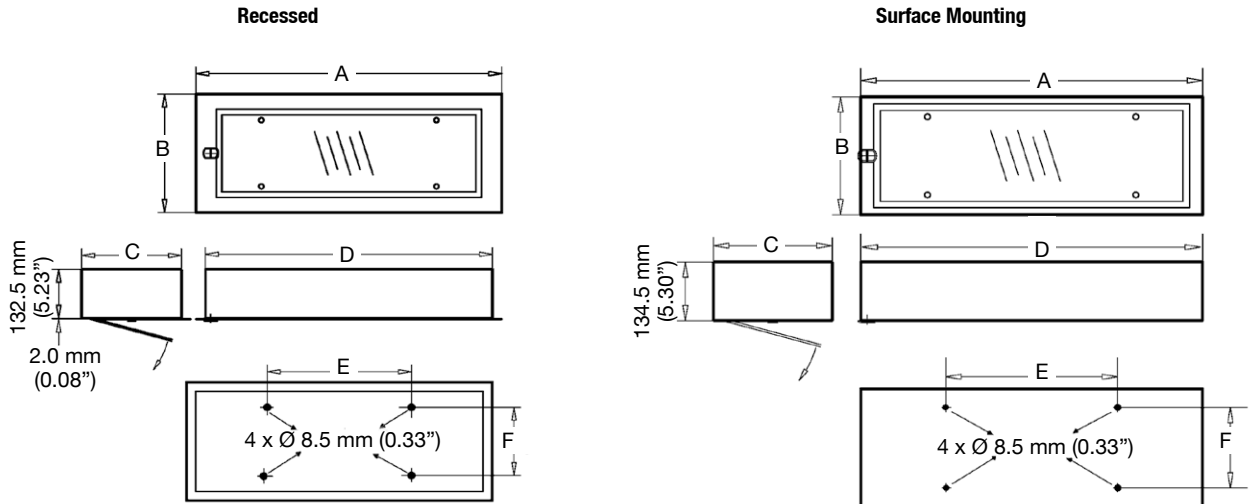

Ceiling Cut-out

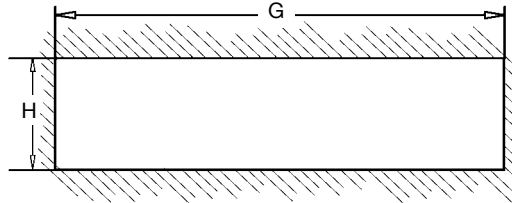

Versions	A	B	C	D	E	F	G	H
18 W (1, 2, 3 lamps)	826 (32.52)	320 (12.60)	270 (10.63)	776 (30.55)	390 (15.35)	184 (7.24)	786 (30.94)	280 (11.02)
18 W (4 lamps)	826 (32.52)	490 (19.29)	440 (17.32)	776 (30.55)	390 (15.35)	354 (13.94)	786 (30.94)	450 (17.72)
36 W (1, 2, 3 lamps)	1436 (56.54)	320 (12.60)	270 (10.63)	1386 (54.57)	1000 (39.37)	184 (7.24)	1396 (54.96)	280 (11.02)
36 W (4 lamps)	1436 (56.54)	490 (19.29)	440 (17.32)	1386 (54.57)	1000 (39.37)	354 (13.94)	1396 (54.96)	450 (17.72)
58 W (1, 2, 3 lamps)	1736 (68.35)	320 (12.60)	270 (10.63)	1686 (66.38)	1300 (51.18)	184 (7.24)	1696 (66.77)	280 (11.02)
58 W (4 lamps)	1736 (68.35)	490 (19.29)	440 (17.32)	1686 (66.38)	1300 (51.18)	354 (13.94)	1696 (66.77)	450 (17.72)

FLUORESCENT/AREA: ATEX/IECEX STANDARD AND EMERGENCY BACK-UP

Appleton

ATX™ RE Series Recessed and Surface Mounting Fluorescent Luminaires

Standard and Emergency Back-Up. Increased Safety

ATEX/IECEX:
 Zone 1 and 2 - 21 and 22
 II 2 GD
 IP66 - IK09/10

FLUORESCENT/AREA: ATEX/IECEX STANDARD AND EMERGENCY BACK-UP

Photometric Data

Polar curves for a 1000 lm flux, according to NF C 71-120
 Luminaire symbol according to NF C 71-121

--- Longitudinal
 — Transverse

1 x 18 W
 Efficiency 67.1%
 NF C 71-121: 0.67 E

CANDELA DISTRIBUTION

	0-180	90-270
0	209	209
5	208	208
10	205	208
15	201	207
20	194	205
25	186	203
30	176	201
35	164	197
40	151	192
45	136	185
50	120	177
55	102	164
60	83	141
65	63	115
70	43	77

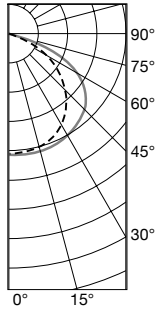

2 x 18 W
 Efficiency 62%
 NF C 71-121: 0.62 E

CANDELA DISTRIBUTION

	0-180	90-270
0	205	205
5	204	203
10	202	203
15	197	202
20	191	201
25	182	201
30	173	200
35	161	192
40	148	183
45	133	177
50	117	173
55	99	168
60	80	168
65	61	163
70	41	154

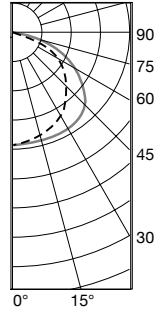

3 x 18 W
 Efficiency 61.2%
 NF C 71-121: 0.61 E

CANDELA DISTRIBUTION

	0-180	90-270
0	201	201
5	200	201
10	197	201
15	193	200
20	187	197
25	179	195
30	169	192
35	158	189
40	145	181
45	131	170
50	115	155
55	98	132
60	80	107
65	61	80
70	41	53

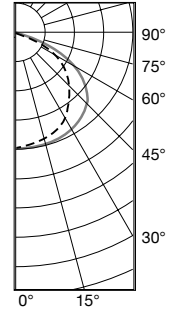

2 x 18 W
 Efficiency 60.5%
 NF C 71-121: 0.60 F

CANDELA DISTRIBUTION

	0-180	90-270
0	196	196
5	195	196
10	193	195
15	189	195
20	183	193
25	175	191
30	166	187
35	155	182
40	143	174
45	129	162
50	114	147
55	98	131
60	79	109
65	60	85
70	40	62

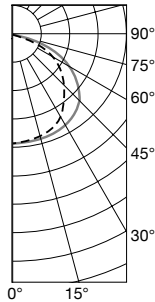

4 x 18 W
 Efficiency 63.7%
 NF C 71-121: 0.63 E

CANDELA DISTRIBUTION

	0-180	90-270
0	194	194
5	193	194
10	191	195
15	186	195
20	181	193
25	173	192
30	164	190
35	153	185
40	141	179
45	128	171
50	113	160
55	96	146
60	78	127
65	60	106
70	40	82

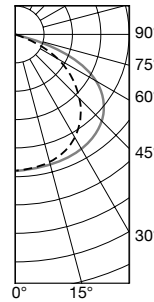

4 x 36 W
 Efficiency 61.5%
 NF C 71-121: 0.61 E

CANDELA DISTRIBUTION

	0-180	90-270
0	190	190
5	289	190
10	287	190
15	183	189
20	177	188
25	170	186
30	162	182
35	151	178
40	139	172
45	126	163
50	111	152
55	96	138
60	78	121
65	60	102
70	42	80

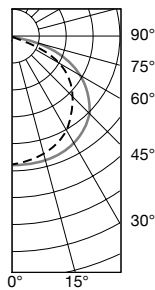

ATX™ RE Series Recessed and Surface Mounting Fluorescent Luminaires

Standard and Emergency Back-Up. Increased Safety

ATEX/IECEX:
 Zone 1 and 2 - 21 and 22
 II 2 GD
 IP66 - IK09/10

Photometric Data

Polar curves for a 1000 lm flux, according to NF C 71-120
 Luminaire symbol according to NF C 71-121

--- Longitudinal
 — Transverse

1 x 36 W
 Efficiency 64.4%
 NF C 71-121: 0.64 E

CANDELA DISTRIBUTION

0-180 90-270		
0	196	196
5	195	196
10	192	196
15	188	194
20	182	192
25	174	189
30	165	188
35	154	185
40	152	181
45	129	176
50	114	170
55	97	159
60	80	143
65	61	116
70	43	76

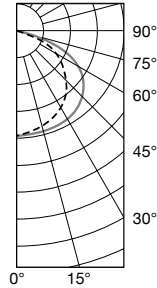

2 x 36 W
 Efficiency 64.8%
 NF C 71-121: 0.64 E

CANDELA DISTRIBUTION

0-180 90-270		
0	198	198
5	197	198
10	194	198
15	190	197
20	184	196
25	176	195
30	167	195
35	156	194
40	144	191
45	130	184
50	115	172
55	98	154
60	80	129
65	62	101
70	43	72

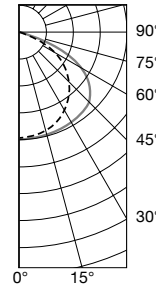

3 x 36 W
 Efficiency 63.7%
 NF C 71-121: 0.63 F

CANDELA DISTRIBUTION

0-180 90-270		
0	207	207
5	207	208
10	204	208
15	199	206
20	193	204
25	185	202
30	175	200
35	164	196
40	151	189
45	136	178
50	120	162
55	103	139
60	84	112
65	65	83
70	45	55

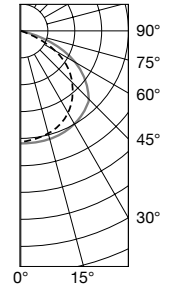

1 x 58 W
 Efficiency 64.9%
 NF C 71-121: 0.65 E

CANDELA DISTRIBUTION

0-180 90-270		
0	189	189
5	188	189
10	187	188
15	184	187
20	181	186
25	176	185
30	170	185
35	162	184
40	150	180
45	136	175
50	119	169
55	102	162
60	83	146
65	63	122
70	43	85

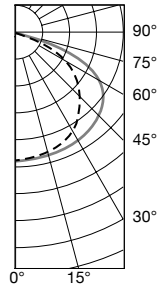

2 x 58 W
 Efficiency 61.8%
 NF C 71-121: 0.62 E

CANDELA DISTRIBUTION

0-180 90-270		
0	182	182
5	182	183
10	181	183
15	178	182
20	174	182
25	170	182
30	164	181
35	156	181
40	145	178
45	131	172
50	116	162
55	99	148
60	81	126
65	52	99
70	43	70

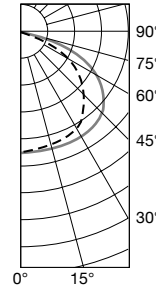

3 x 58 W
 Efficiency 57.8%
 NF C 71-121: 0.58 E

CANDELA DISTRIBUTION

0-180 90-270		
0	185	185
5	185	185
10	183	185
15	181	184
20	177	182
25	172	180
30	166	178
35	159	174
40	147	168
45	133	158
50	118	144
55	100	125
60	82	101
65	63	75
70	43	49

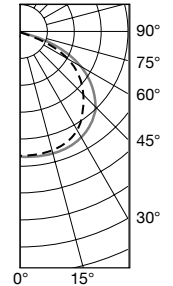

FLUORESCENT / AREA: ATEX / IECEX STANDARD AND EMERGENCY BACK-UP



ATX™ FD Series Cylindrical Fluorescent Luminaires

Standard and Emergency Battery Back-Up. Flameproof

ATEX/IECEX:
Zone 1 and 2 - 21 and 22
Ⓢ II 2 GD
IP66/68

FLUORESCENT/AREA: ATEX/IECEX STANDARD AND EMERGENCY BACK-UP

Applications

- Can be installed in hazardous areas designated as Zone 1 and 2 – 21 and 22.
- For use in locations where a high degree of corrosion resistance is required.
- For indoor/outdoor use where protection against dirt, water and moisture is necessary.
- Typical applications include:
 - Oil refineries
 - Petrochemical facilities
 - Pulp and paper, mills
 - Painting, sewage and water treatment facilities
 - Warehouses
 - Underground tunnels
 - General manufacturing facilities

Features

- Impact resistant borosilicate glass sealed tube.
- Easy access to lamps through gray painted Zamak threaded entry cap.
- Supplied with O-ring for improved ingress protection.
- Corrosion-resistant gray painted Zamak.
- Supplied with energy efficient and self induction ferromagnetic ballast on a removable gear tray.
- Quick and easy installation of fluorescent lighting fixtures with 2G11 and G13 lamp holders.
- Supplied with external and internal ground/earth connection.
- Fixture supplied with one M20 blanking plug.
- Easy connection to wire and disconnect with plug-in terminal blocks.
- Bi-pin (G13) 18 and 36 W magnetic ballast versions operate at 70 °C (158°F) ambient temperature with T4 rating.
- Magnetic ballast versions 230 V 50 Hz or 240 V 50 Hz or 220 V 60 Hz or 230 V 60 Hz.
- Electronic ballast versions 110 to 254 Vac/Vdc, 50/60 Hz.
- 3 hour emergency version with automatic self test every month
- Plug in battery pack (6 V 4 Ah) is easy to remove for maintenance.

Standard Materials

- End caps and cover: aluminum
- Glass tube: tempered borosilicate glass (18 W), or borosilicate glass (36 W and 58 W)
- Internal reflector: white powder coated galvanized steel
- Mounting accessories: several accessories in different material such as zinc plated steel, galvanized steel or 316 stainless steel

Options

- 3 lamp versions.
- 8 W fluorescent (Bi-pin G5) available, see section HBDC series.



2 x 58 W



2 x 36 W



2 x 18 W

ATEX/IECEX Certifications and Compliances

- Certification Type: FLd
 - Gas: Zone 1 and 2:
 - Conforming to ATEX 94/9/CE: Ⓢ II 2 G
 - Type of Protection: Ex d IIB, Ex d IIB+H₂, Ex d IIC
 - T-Rating: See Table on following page
 - Dust: Zone 21 and 22:
 - Conforming to ATEX 94/9/CE: Ⓢ II 2 D
 - Type of Protection: Ex tD A21
 - Surface Temperature: See Table on following page
- Ambient Temperature: -20 °C to +55 °C (-4 °F to +131 °F)
- CE Declaration of Conformity: 50203
- ATEX Certificate: LCIE 97 ATEX 6012
- IECEx Certificate: IECEx LCI 04.0018
- Index of Protection according EN/IEC 60529: IP66/68
- Impact Resistance (shock): IK08
- Internal Volume: > 2 dm³ (122 in³) - 2 liters

EURASEC Certification

- EURASEC N° TC RU C-FR.ГБ05.B.00910

Other Certification

- INMETRO Certificate: BVC11.0492 ①

Related Products

- For labels see *Labels for Emergency Lighting Units*, *ATX Self-Adhesive Signaling Labels for Emergency Lighting Units*.

① Inmetro certification available on special request only. Contact your local sales representative for more information.

ATX™ FD Series Cylindrical Fluorescent Luminaires

Standard and Emergency Battery Back-Up. Flameproof

ATEX/IECEX:
Zone 1 and 2 - 21 and 22
II 2 GD
IP66/68

Order using catalog numbering guide below or select catalog number from tables on following pages.

Catalog Numbering Guide – FD Series Cylindrical Fluorescent Luminaires

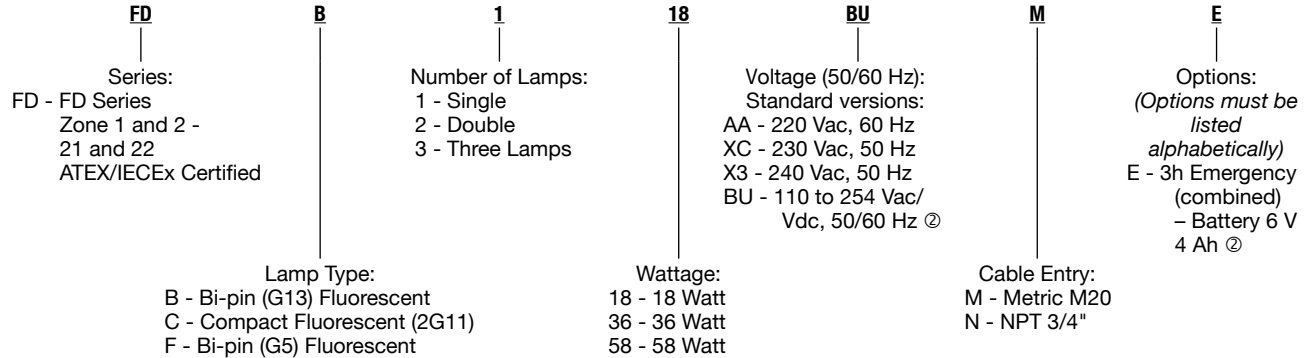

T Rating (Gas) and Surface Temperature (Dust) Table

Model	Lamp Type	Gas – T Rating					Dust – Surface Temperature	
		Without External Reflector			With External Reflector		Without External Reflector	With External Reflector
		Ta = 40 °C (104 °F)	Ta = 55 °C (131 °F)	Ta = 70 °C (158 °F)	Ta = 40 °C (104 °F)	Ta = 55 °C (131 °F)		
0.3	Compact Fluorescent 2G11 18 W max.	T6	T5	N.A.	T5	T4	95 °C (203 °F)	130 °C (266 °F)
	a) Fluorescent G13 Magnetic Ballast 1 x 18 W/2 x 18 W	T6	T5	T4	T6	T5	97 °C (207 °F)	95 °C (203 °F)
0.6	b) Fluorescent G13 Electronic Ballast 1 x 18 W/2 x 18 W/3 x 18 W	T6	T6	N.A.	T6	T5	78 °C (172 °F)	95 °C (203 °F)
	c) Compact Fluorescent 2G11 1 x 36 W 2 x 36 W	T6	T5	N.A.	T6 T5	T4	95 °C (203 °F)	130 °C (266 °F)
1.2	a) Fluorescent G13 Magnetic Ballast 1 x 36 W/2 x 36 W/3 x 36 W	T6	T5	T4	T6	T5	110 °C (230 °F)	95 °C (203 °F)
	b) Fluorescent G13 Electronic Ballast 1 x 36 W/2 x 36 W/3 x 36 W	T6	T6	N.A.	T6	T6	78 °C (172 °F)	80 °C (176 °F)
1.5	a) Fluorescent G13 Magnetic Ballast 1 x 58 W/2 x 58 W	T6	T6	N.A.	T6	T5	80 °C (176 °F)	95 °C (203 °F)
	b) Fluorescent G13 Electronic Ballast 1 x 58 W/2 x 58 W/3 x 58 W	T6	T5	N.A.	T6	T5	84 °C (183 °F)	95 °C (203 °F)

② The 3 hour emergency version is only available on fluorescent, 2 lamp fixtures with BU voltage - 110 to 254 Vac/Vdc, 50/60 Hz.

ATX™ FD Series Cylindrical Fluorescent Luminaires

Standard and Emergency Battery Back-Up. Flameproof

ATEX/IECEX:
 Zone 1 and 2 - 21 and 22
 II 2 GD
 IP66/68

FLUORESCENT/AREA: ATEX/IECEX STANDARD AND EMERGENCY BACK-UP

Ordering Information – Standard Versions

Two M20 threaded entries, supplied with one M20 aluminum blanking plug.
 Connection via 1 x 3 double deck terminals.
 Capacity (flexible/solid): 0.75 mm² to 2.5 mm² (0.001 in² to 0.004 in²).

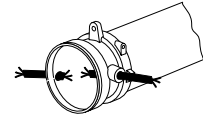

For Bi-pin (G13) Fluorescent Lamps - T8, 26 mm (1.02 in) or T12, 38 mm (1.50 in)
 230 V - 50 Hz – Magnetic Ballast – Starter Ignition
 Compensated power supply – power factor > 0.9

Wattage (W)	No. of Lamps	Gas Group	Model	Weight kg (lb)	Volume dm ³ (in ³)	Catalog Number
18	1	IIC	0.6	9.0 (19.8)	58 (3539.38)	FDB118XCM
	2	IIC	0.6	9.7 (21.38)	58 (3539.38)	FDB218XCM
36	1	IIB+H ₂	1.2	14.7 (32.41)	99 (6041.35)	FDB136XCM
	2	IIB+H ₂	1.2	15.3 (33.73)	99 (6041.35)	FDB236XCM
58	1	IIB	1.5	17.0 (37.48)	119 (7261.83)	FDB158XCM
	2	IIB	1.5	18.2 (40.12)	119 (7261.83)	FDB258XCM

240 V - 50 Hz – Magnetic Ballast – Starter Ignition

Compensated power supply – power factor > 0.9

18	1	IIC	0.6	9.0 (19.8)	58 (3539.38)	FDB118X3M
	2	IIC	0.6	9.7 (21.38)	58 (3539.38)	FDB218X3M
36	1	IIB+H ₂	1.2	14.7 (32.41)	99 (6041.35)	FDB136X3M
	2	IIB+H ₂	1.2	15.3 (33.73)	99 (6041.35)	FDB236X3M
58	1	IIB	1.5	17.0 (37.48)	119 (7261.83)	FDB158X3M
	2	IIB	1.5	18.2 (40.12)	119 (7261.83)	FDB258X3M

220 V - 60 Hz – Magnetic Ballast – Starter Ignition

Compensated power supply – power factor > 0.9

18	2	IIC	0.6	9.7 (21.38)	58 (3539.38)	FDB218AAM
36	2	IIB+H ₂	1.2	15.3 (33.73)	99 (6041.35)	FDB236AAM
58	2	IIB	1.5	18.2 (40.12)	119 (7261.83)	FDB258AAM

ATX™ FD Series Cylindrical Fluorescent Luminaires

Standard and Emergency Battery Back-Up. Flameproof

ATEX/IECEX:
 Zone 1 and 2 - 21 and 22
 II 2 GD
 IP66/68

Ordering Information – Standard Versions – Continued

Two M20 threaded entries, supplied with one M20 aluminum blanking plug.
 Connection via 1 x 3 double deck terminals.
 Capacity (flexible/solid): 0.75 mm² to 2.5 mm² (0.001 in² to 0.004 in²).

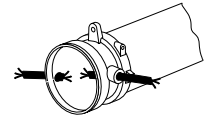

For Bi-pin (G13) Fluorescent Lamps - T8, 26 mm (1.02 in) or T12, 38 mm (1.50 in)
 110 to 254 Vac/Vdc, 50/60 Hz – Electronic Ballast
 Power factor > 0.95

Wattage (W)	No. of Lamps	Gas Group	Model	Weight kg (lb)	Volume dm ³ (in ³)	Catalog Number
18	2	IIC	0.6	9.7 (21.38)	58 (3539.38)	FDB218BUM
36	2	IIB	1.2	15.3 (33.73)	99 (6041.35)	FDB236BUM
	3	IIB	1.2	16.3 (35.94)	99 (6041.35)	FDB336BUM
58	1	IIB	1.5	17.0 (37.48)	119 (7261.83)	FDB158BUM
	2	IIB	1.5	18.2 (40.12)	119 (7261.83)	FDB258BUM
	3	IIB	1.5	19.2 (42.33)	119 (7261.83)	FDB358BUM

For 2G11 Compact Fluorescent Lamps – TC-L
 230 V - 50 Hz – Magnetic Ballast – Starter Ignition
 Compensated power supply – power factor > 0.9 – Lamps supplied

18	1	IIC	0.3	9.0 (19.8)	58 (3539.38)	FDC118XCM
	2	IIC	0.3	9.7 (21.38)	58 (3539.38)	FDC218XCM
36	1	IIB+H ₂	0.6	14.7 (32.41)	99 (6041.35)	FDC136XCM
	2	IIB+H ₂	0.6	15.3 (33.73)	99 (6041.35)	FDC236XCM

Emergency Versions

Two M20 threaded entries, supplied with one M20 aluminum blanking plug.
 Connection via 1 x 4 double deck terminals.
 Capacity (flexible/solid): 0.75 mm² to 2.5 mm² (0.001 in² to 0.004 in²).

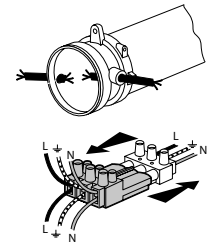

For Bi-pin (G13) Fluorescent Lamps – T8, 26 mm (1.02 in) or T12, 38 mm (1.50 in)
 110 to 254 Vac/Vdc, 50/60 Hz – Electronic Ballast
 3 hour duration - battery pack 6 V 4 Ah - Power factor > 0.95 -
 Self test every month.

Wattage (W)	No. of Lamps	Gas Group	Model	Line Output	Weight kg (lb)	Volume dm ³ (in ³)	Catalog Number
18	2	IIC	0.6	29%	11.6 (25.57)	58 (3539.38)	FDB218BUME
36	2	IIB	1.2	16%	17.2 (37.92)	99 (6041.35)	FDB236BUME
58	2	IIB	1.5	11%	20.2 (44.53)	119 (7261.83)	FDB258BUME



ATX™ FD Series Cylindrical Fluorescent Luminaires

Standard and Emergency Battery Back-Up. Flameproof

ATEX/IECEX:
 Zone 1 and 2 - 21 and 22
 II 2 GD
 IP66/68

FLUORESCENT/AREA: ATEX/IECEX STANDARD AND EMERGENCY BACK-UP

Accessories and Replacement Parts

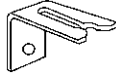
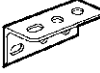
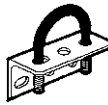
	Description	Catalog Number
External Reflector – White Painted Galvanized Steel		
	Model 0.3	FDER1G
	Model 0.6	FDER2G
	Model 1.2	FDER3G
	Model 1.5	FDER4G
Protective Guard – Zinc Plated Steel		
	Model 0.3	FDPG1Z
	Model 0.6	FDPG2Z
	Model 1.2	FDPG3Z
	Model 1.5	FDPG4Z
Fixing Brackets for Ease of Surface Installation – Set of Two		
	Zinc plated steel	FDFBZ
	316 stainless steel	FDFBS
Surface Mounting Brackets – Set of Two		
	Zinc plated steel	FDSBZ
	316 stainless steel	FDSBS
Half Clamp Brackets for Pole Mounting – Set of Two		
	Pole diameter 42 to 49 mm (1.65 to 1.93 in) Tube diameter 31.8 to 38.1 mm (1.25 to 1.5 in)	
	Zinc plated steel	FDHC49Z
	316 stainless steel	FDHC49S
	Pole diameter 60 mm (2.36 in) Tube diameter 50.8 mm (2 in)	
	Zinc plated steel	FDHC60Z
	316 stainless steel	FDHC60S
Fall Prevention Kit		
	1.20 meter (3.94 foot) stainless steel chain	FDSCS

ATX™ FD Series Cylindrical Fluorescent Luminaires

Standard and Emergency Battery Back-Up. Flameproof

ATEX/IECEX:
 Zone 1 and 2 - 21 and 22
 II 2 GD
 IP66/68

Wiring Diagram

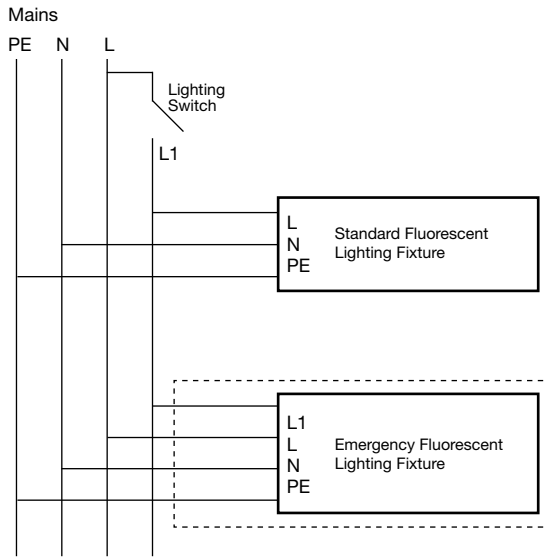

Emergency Function Diagram

Two Lamp Version

Mains	Lighting Switch ON	Lighting Switch OFF
ON		
OFF		

LED Status

Color	Indication	Function
Green	Blinking 1:1	Mains good, battery quick charging
	ON	Mains good, battery trickle charging
Red	Blinking 1:1	No battery connected or something is defective
	Flashing 1:1	Mains faulty, battery empty or lamp defective
	ON	Mains faulty, output ON
Yellow	OFF	No mains, battery completely empty
	Blinking 1:1	Mains good, performing self test
	ON	Result of self test was not good

Dimensions in Millimeters (Inches)

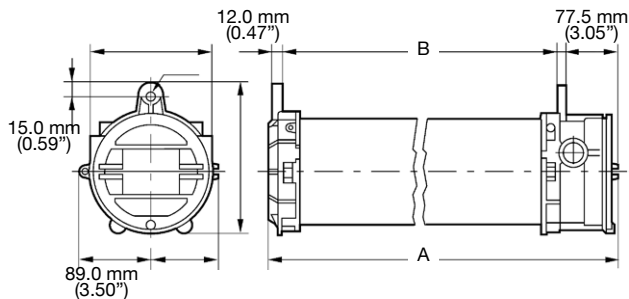

Model	A	B
0.3	430 (16.93)	335 (13.19)
0.6	745 (29.33)	650 (25.59)
1.2	1365 (53.74)	1260 (49.61)
1.5	1655 (65.16)	1560 (61.42)

ATX™ FD Series Cylindrical Fluorescent Luminaires

Standard and Emergency Battery Back-Up. Flameproof

ATEX/IECEX:
Zone 1 and 2 - 21 and 22
II 2 GD
IP66/68

FLUORESCENT/AREA: ATEX/IECEX STANDARD AND EMERGENCY BACK-UP

Photometric Data

Polar curves for a 1000 lm flux, according to NF C 71-120
Luminaire symbol according to NF C 71-121

--- Longitudinal
— Transverse

Bi-pin (G13) Fluorescent

2G11 Compact Fluorescent

1 x 18 W
Efficiency 75.3%
NF C 71-121/0: 0.69 H + 0.06 T

2 x 18 W
Efficiency 68.1%
NF C 71-121: 0.63 G + 0.06 T

3 x 18 W
Efficiency 57%
NF C 71-121: 0.50 G + 0.07 T

2 x 18 W
Efficiency 56.2%
NF C 71-121: 0.52 G + 0.04 T

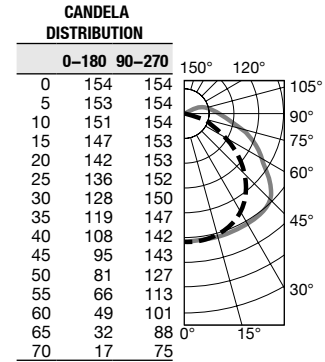
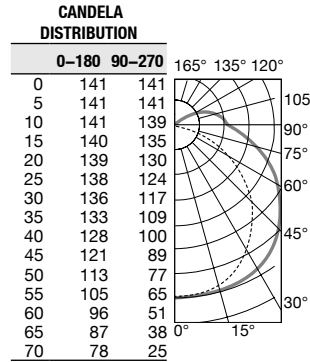
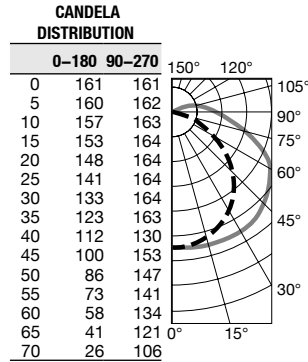
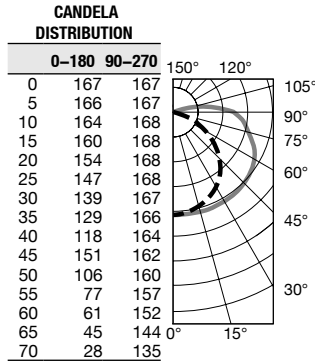

1 x 36 W
Efficiency 74.3%
NF C 71-121/0: 0.69 H + 0.05 T

2 x 36 W
Efficiency 61.5%
NF C 71-121: 0.57 G + 0.04 T

3 x 36 W
Efficiency 53.3%
NF C 71-121: 0.47 G + 0.06 T

2 x 36 W
Efficiency 53.6%
NF C 71-121: 0.50 G + 0.04 T

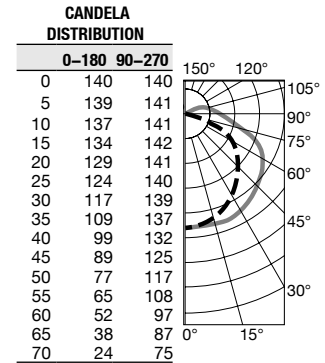
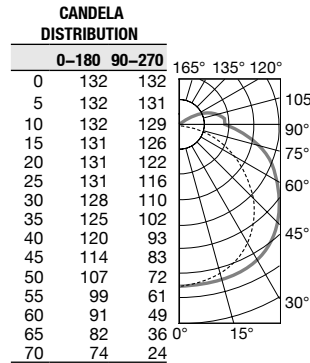
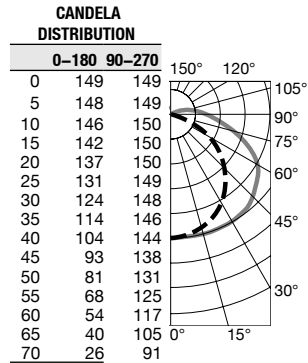
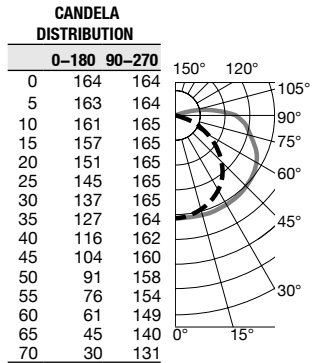

1 x 58 W
Efficiency 74.5%
NF C 71-121/0: 0.70 H + 0.05 T

2 x 36 W
Efficiency 61.5%
NF C 71-121: 0.57 G + 0.04 T

3 x 36 W
Efficiency 53.3%
NF C 71-121: 0.47 G + 0.06 T

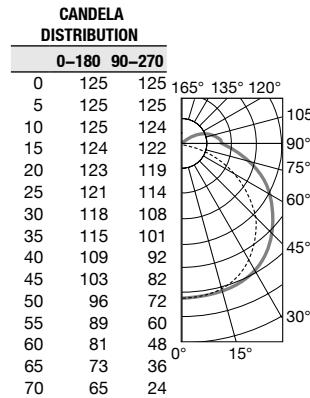
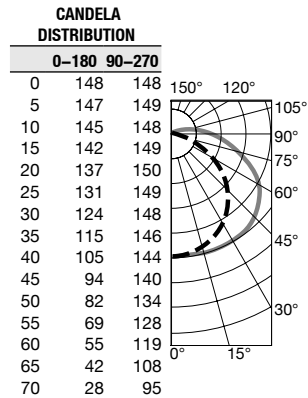
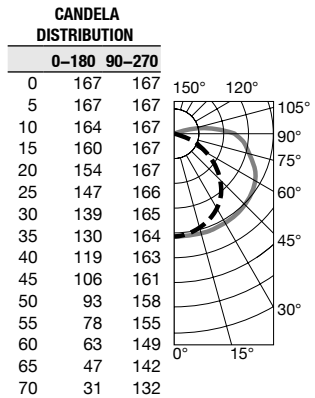

ATX™ FE Series Nonmetallic Fluorescent Luminaires

Standard and Emergency Battery Back-Up. Increased Safety

ATEX/IECEX:
Zone 1 and 2 - 21 and 22
II 2 GD
IP66/67 - IK10

Applications

- Can be installed in hazardous areas designated as Zone 1 and 2 - 21 and 22.
- For use in locations where a high degree of corrosion resistance is required.
- For indoor/outdoor use where protection against dirt, water and moisture is necessary.
- Typical applications include oil refineries, petrochemical facilities, pulp and paper mills, food processing plants, warehouses, underground tunnels and general manufacturing facilities.

Features

- Corrosion-resistant fiberglass reinforced polyester body and hinged polycarbonate lens.
- High impact resistance housing (20 Joules - IK10) from -40 °C to +55 °C (-40 °F to +131 °F) ambient temperature and wind profile for use in extreme offshore and onshore environments.
- Latch assembly and elastomer gasket seals against water and dust ingress, IP66/67.
- Easily accessed for maintenance using Allen key or straight blade screwdriver.
- Central opening with unique patented release system to prevent damage.
- Can be horizontally or vertically mounted.
- Hinged parabolic reflector for high lumen output efficiency.
- Vibration resistant spring loaded lampholders for bi-pin (G13) or mono-pin (Fa6) versions.
- Positive safety switch disconnects power to lamps and ballast to allow maintenance in hazardous locations.
- Electronic multi-tap ballast 110 to 254 Vac/Vdc +/- 10% 50/60 Hz, for global applications. High power factor electronic ballast (>0.95). EOL (End Of Life) protection in accordance to the latest EN/IEC 60079-7 standard.
- Two channel ballast prevents dark areas by allowing one lamp to remain lit if one fails.
- Ballast plug-in with Ex e connector for quick and error-free maintenance.
- Available in 3 hour or 90 minute emergency versions, including multi-tap ballast with built-in monthly self test. Test results through multi-colored LED.
- Ex e battery with plug-in connector.

Standard Materials

- Fiberglass reinforced polyester housing
- Polycarbonate lens
- Elastomer gasket
- Highly reflective white polycarbonate internal reflector
- Mounting accessories available in different materials such as gray painted aluminum, zinc plated steel, galvanized steel or 316 stainless steel

Options

- Silicone coating for added protection in H₂S hydrogen sulfide environments.
- ATEX/IEC version available without safety switch.
- Level gauge light fitting.
- 316 stainless steel fixing inserts.



2 x 58 W



2 x 36 W



2 x 18 W

ATEX/IECEX Certifications and Compliances

- Certification Type: FLE
 - Gas: Zones 1 and 2:
 - Conforming to ATEX 94/9/CE: II 2 G
 - Type of Protection: Ex de IIC or Ex demb IIC (emergency version)
 - T-Rating: T5 to T4
 - Dust: Zone 21 and 22:
 - Conforming to ATEX 94/9/CE: II 2 D
 - Type of Protection: Ex t IIIC Db
 - Surface Temperature: +75 °C (+167 °F)
- Ambient Temperature: -40 °C to +55 °C (-40 °F to +131 °F)
- CE Declaration of Conformity: 50201
- ATEX Certificate: LCIE 07 ATEX 6017
- IECEX Certificate: IECEX LCI 04.0017
- Index of Protection according EN/IEC 60529: IP66/67
- Impact Resistance (shock): IK10

EURASEC Certification

- EURASEC N° TC RU C-FR.Г505.B.00910

Other Certification

- INMETRO Certificate: BVC11.0276

① Inmetro certification available on special request only. Contact your local sales representative for more information.

② With ceiling position use at +40 °C (+104 °F) ambient temperature.

ATX™ FE Series Nonmetallic Fluorescent Luminaires

Standard and Emergency Battery Back-Up. Increased Safety

ATEX/IECEX:
 Zone 1 and 2 - 21 and 22
 II 2 GD
 IP66/67 - IK10

FLUORESCENT/AREA: ATEX/IECEX STANDARD AND EMERGENCY BACK-UP

Order using catalog numbering guide below or select catalog number from tables on following pages.

Catalog Numbering Guide — FE Nonmetallic Fluorescent Lighting Fixtures

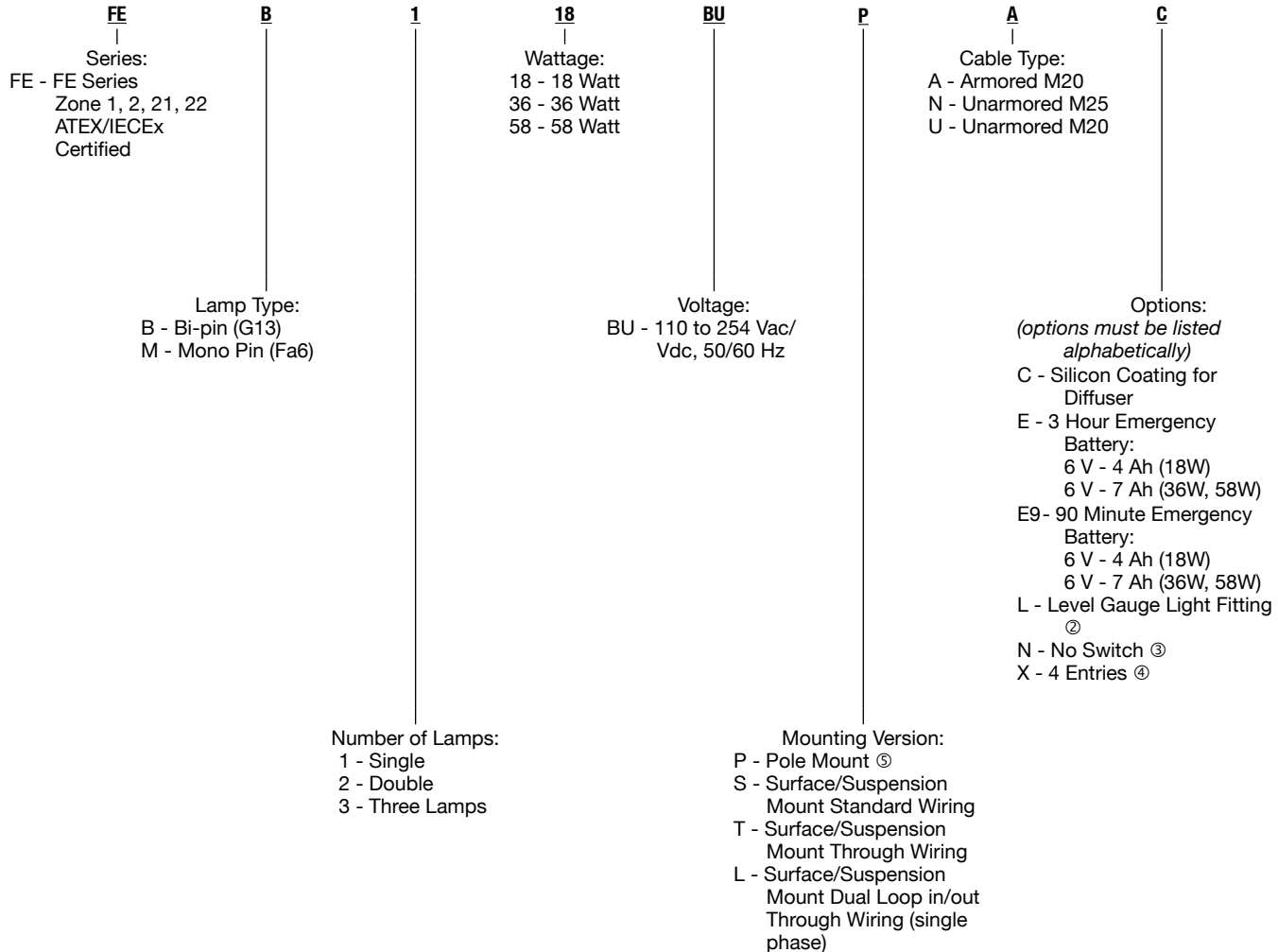

② Only for single standard versions.

③ Only for standard versions.

④ Only for S, T and L mounting versions.

⑤ Only 2 x 18 W and 2 x 36 W with M25 entry versions.

ATX™ FE Series Nonmetallic Fluorescent Luminaires

Standard and Emergency Battery Back-Up. Increased Safety

ATEX/IECEX:
 Zone 1 and 2 - 21 and 22
 II 2 GD
 IP66/67 - IK10

Surface/Suspension Mounting and Standard Wiring Version

Connection via 1 x 6 terminals.
 Capacity (flexible/solid): 4 mm²/6 mm²
 (0.0062 in²/0.0093 in²) — 10/8 AWG.

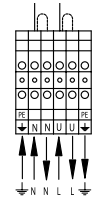
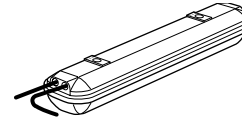

Unarmored Version - Bi-pin (G13)

Three M25 threaded entries, two at one end and one at opposite end, supplied with one M25 polyamide cable gland — 8 to 18.5 mm (0.31 to 0.73") diameter — and two M25 polyamide plugs.

Number of Lamps	Power (W)	Lamp Type	Voltage (V)	Weight kg (lbs)	Volume dm ³ (in ³)	Catalog Number
1	18	G13	110/254	5.5 (12.13)	32.3 (1971.07)	FEB118BUSN
2	18	G13	110/254	5.5 (12.13)	32.3 (1971.07)	FEB218BUSN
1	36	G13	110/254	7.9 (17.42)	54.2 (3307.49)	FEB136BUSN
2	36	G13	110/254	7.9 (17.42)	54.2 (3307.49)	FEB236BUSN
3	36	G13	110/254	9.9 (21.83)	54.2 (3307.49)	FEB336BUSN
1	58	G13	110/254	9.0 (19.84)	65.0 (3966.54)	FEB158BUSN
2	58	G13	110/254	9.0 (19.84)	65.0 (3966.54)	FEB258BUSN
3	58	G13	110/254	11.0 (24.30)	65.0 (3966.54)	FEB358BUSN

Armored Version - Bi-pin (G13)

Two M20 threaded entries with brass earth continuity plate at one end and one M20 plugged clearance entry, supplied with two M20 polyamide plugs.

Number of Lamps	Power (W)	Lamp Type	Voltage (V)	Weight kg (lbs)	Volume dm ³ (in ³)	Catalog Number
1	18	G13	110/254	5.5 (12.13)	32.3 (1971.07)	FEB118BUSA
2	18	G13	110/254	5.5 (12.13)	32.3 (1971.07)	FEB218BUSA
1	36	G13	110/254	7.9 (17.42)	54.2 (3307.49)	FEB136BUSA
2	36	G13	110/254	7.9 (17.42)	54.2 (3307.49)	FEB236BUSA
3	36	G13	110/254	9.9 (21.83)	54.2 (3307.49)	FEB336BUSA
1	58	G13	110/254	9.0 (19.84)	65.0 (3966.54)	FEB158BUSA
2	58	G13	110/254	9.0 (19.84)	65.0 (3966.54)	FEB258BUSA
3	58	G13	110/254	11.0 (24.30)	65.0 (3966.54)	FEB358BUSA

FLUORESCENT / AREA: ATEX/IECEX STANDARD AND EMERGENCY BACK-UP

Appleton

ATX™ FE Series Nonmetallic Fluorescent Luminaires

Standard and Emergency Battery Back-Up. Increased Safety

ATEX/IECEX:
 Zone 1 and 2 - 21 and 22
 II 2 GD
 IP66/67 – IK10

FLUORESCENT/AREA: ATEX/IECEX STANDARD AND EMERGENCY BACK-UP

Surface/Suspension Mounting and Through Wiring Version (three phase)

Connection via 2 x 5 terminals.
 Capacity (flexible/solid): 4 mm²/6 mm² (0.0062 in²/0.0093 in²) – 10/8 AWG.

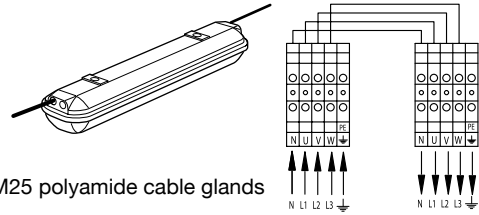

Unarmored Version - Bi-pin (G13)

Three M25 threaded entries, two at one end and one at opposite end, supplied with two M25 polyamide cable glands – 8 to 18.5 mm (0.31 to 0.73") diameter – and one M25 polyamide plug.

Number of Lamps	Power (W)	Lamp Type	Voltage (V)	Weight kg (lbs)	Volume dm ³ (in ³)	Catalog Number
2	18	G13	110/254	5.5 (12.13)	32.3 (1971.07)	FEB218BUTN
2	36	G13	110/254	7.9 (17.42)	54.2 (3307.49)	FEB236BUTN
2	58	G13	110/254	9.0 (19.84)	65.0 (3966.54)	FEB258BUTN

Armored Version - Bi-pin (G13)

Two M20 threaded entries with brass earth continuity plate at one end and one M20 threaded entry with brass earth continuity plate at opposite end, supplied with one M20 polyamide plug.

Number of Lamps	Power (W)	Lamp Type	Voltage (V)	Weight kg (lbs)	Volume dm ³ (in ³)	Catalog Number
2	18	G13	110/254	5.5 (12.13)	32.3 (1971.07)	FEB218BUTA
2	36	G13	110/254	7.9 (17.42)	54.2 (3307.49)	FEB236BUTA
2	58	G13	110/254	9.0 (19.84)	65.0 (3966.54)	FEB258BUTA

Surface/Suspension Mounting and Dual Loop In/Out Through Wiring Version (single phase)

Connection via 1 x 6 terminals and 1 x 3 terminals.
 Capacity (flexible/solid): 4 mm²/6 mm² (0.0062 in²/0.0093 in²) – 10/8 AWG.

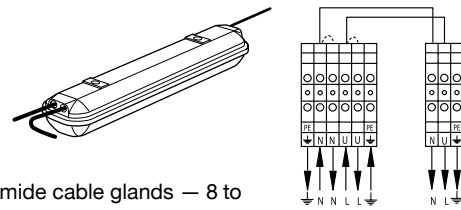

Unarmored Version - Bi-pin (G13)

Three M25 entries, two at one end and one at opposite end, supplied with two M25 polyamide cable glands – 8 to 18.5 mm (0.31 to 0.73") diameter – and one M25 polyamide plug.

Number of Lamps	Power (W)	Lamp Type	Voltage (V)	Weight kg (lbs)	Volume dm ³ (in ³)	Catalog Number
2	18	G13	110/254	5.5 (12.13)	32.3 (1971.07)	FEB218BULN
2	36	G13	110/254	7.9 (17.42)	54.2 (3307.49)	FEB236BULN
2	58	G13	110/254	9.0 (19.84)	65.0 (3966.54)	FEB258BULN

Armored Version - Bi-pin (G13)

Two M20 threaded entries with brass earth continuity plate at one end and one M20 threaded entry with brass earth continuity plate at opposite end, supplied with one M20 polyamide plug.

Number of Lamps	Power (W)	Lamp Type	Voltage (V)	Weight kg (lbs)	Volume dm ³ (in ³)	Catalog Number
2	18	G13	110/254	5.5 (12.13)	32.3 (1971.07)	FEB218BULA
2	36	G13	110/254	7.9 (17.42)	54.2 (3307.49)	FEB236BULA
2	58	G13	110/254	9.0 (19.84)	65.0 (3966.54)	FEB258BULA

ATX™ FE Series Nonmetallic Fluorescent Luminaires

Standard and Emergency Battery Back-Up. Increased Safety

ATEX/IECEX:
 Zone 1 and 2 - 21 and 22
 II 2 GD
 IP66/67 - IK10

Pole Mounting Version

Connection via 1 x 3 terminals.
 Capacity (flexible/solid): 4 mm²/6 mm² (0.0062 in²/0.0093 in²) — 10/8 AWG.
 For mounting on 42 mm (1.65") diameter pole or tubular wall-mounting support, supplied with one integrated M25 polyamide cable gland — 8 to 18.5 mm (0.31 to 0.73") diameter.

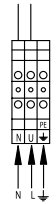
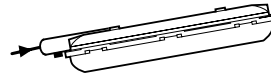

Number of Lamps	Power (W)	Lamp Type	Voltage (V)	Weight kg (lbs)	Volume dm ³ (in ³)	Catalog Number
2	18	G13	110/254	6.2 (13.67)	34.1 (2080.91)	FEB218BUPN
2	36	G13	110/254	8.7 (19.18)	54.2 (3307.49)	FEB236BUPN

Level Gauge Tank Light - Surface/Suspension Mounting with Standard Wiring

Connection via 1 x 6 terminals.
 Capacity (flexible/solid): 4 mm²/6 mm² (0.0062 in²/0.0093 in²) — 10/8 AWG.

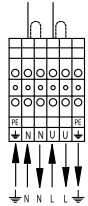
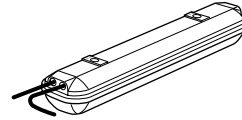

Unarmored Version - Bi-pin (G13)

Three M25 entries, two at one end and one at opposite end, supplied with one M25 polyamide cable gland — 8 to 18.5 mm (0.31 to 0.73") diameter — and two M25 polyamide plugs.

Number of Lamps	Power (W)	Lamp Type	Voltage (V)	Weight kg (lbs)	Volume dm ³ (in ³)	Catalog Number
1	18	G13	110/254	5.5 (12.13)	32.3 (1971.07)	FEB118BUSNL
1	36	G13	110/254	7.9 (17.42)	54.2 (3307.49)	FEB136BUSNL
1	58	G13	110/254	9.0 (19.84)	65.0 (3966.54)	FEB158BUSNL

FLUORESCENT / AREA: ATEX / IECEX STANDARD AND EMERGENCY BACK-UP



ATX™ FE Series Nonmetallic Fluorescent Luminaires

Standard and Emergency Battery Back-Up. Increased Safety

ATEX/IECEX:
 Zone 1 and 2 - 21 and 22
 II 2 GD
 IP66/67 - IK10

FLUORESCENT/AREA: ATEX/IECEX STANDARD AND EMERGENCY BACK-UP

Emergency Battery Backup

Surface/Suspension Mounting and Standard Wiring

Connection via 1 x 4 terminals for 18 W version.
 Connection via 1 x 8 terminals for 36 W and 58 W versions. Capacity (flexible/solid): 4 mm²/6 mm² (0.0062 in²/0.0093 in²) — 10/8 AWG.

Unarmored Version - Bi-pin (G13)

Three M25 entries, two at one end and one at opposite end, supplied with one M25 polyamide cable gland — 8 to 18.5 mm (0.31 to 0.73") diameter — and two M25 polyamide plugs.

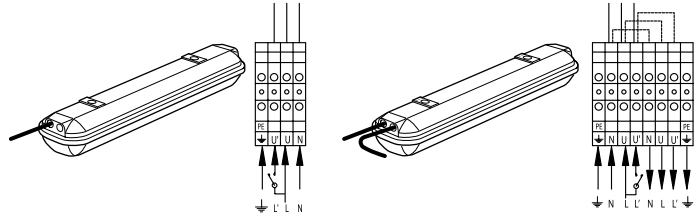

Number of Lamps	Power (W)	Lamp Type	Voltage (V)	Weight kg (lbs)	Volume dm ³ (in ³)	Duration (Hours)	Battery Capacity	Catalog Number
2	18	G13	110/254	7.3 (16.09)	32.3 (1971.07)	3 H	4Ah	FEB218BUSNE
2	36	G13	110/254	9.6 (21.16)	54.2 (3307.49)	3 H	7Ah	FEB236BUSNE
3	36	G13	110/254	11.6 (25.57)	54.2 (3307.49)	3 H	7Ah	FEB336BUSNE
2	58	G13	110/254	10.7 (23.59)	65.0 (3966.54)	3 H	7Ah	FEB258BUSNE
3	58	G13	110/254	12.7 (28.00)	65.0 (3966.54)	3 H	7Ah	FEB358BUSNE

Armored Version - Bi-pin (G13)

Two M20 threaded entries with brass earth continuity plate at one end and one M20 plugged clearance entry, supplied with two M20 polyamide plugs.

Number of Lamps	Power (W)	Lamp Type	Voltage (V)	Weight kg (lbs)	Volume dm ³ (in ³)	Duration (Hours)	Battery Capacity	Catalog Number
2	18	G13	110/254	7.3 (16.09)	32.3 (1971.07)	3 H	4Ah	FEB218BUSAE
2	36	G13	110/254	9.6 (21.16)	54.2 (3307.49)	3 H	7Ah	FEB236BUSAE
3	36	G13	110/254	11.6 (25.57)	54.2 (3307.49)	3 H	7Ah	FEB336BUSAE
2	58	G13	110/254	10.7 (23.59)	65.0 (3966.54)	3 H	7Ah	FEB258BUSAE
3	58	G13	110/254	12.7 (28.00)	65.0 (3966.54)	3 H	7Ah	FEB358BUSAE

Appleton

ATX™ FE Series Nonmetallic Fluorescent Luminaires

Standard and Emergency Battery Back-Up. Increased Safety

ATEX/IECEX:
 Zone 1 and 2 - 21 and 22
 II 2 GD
 IP66/67 - IK10

Emergency Battery Backup

Surface/Suspension Mounting and Through Wiring Version

Connection via 2 x 4 terminals.
 Capacity (flexible/solid): 4 mm²/6 mm² (0.0062 in²/0.0093 in²) – 10/8 AWG.

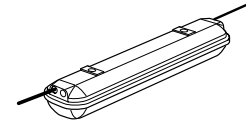

Unarmored Version - Bi-pin (G13):

Three M25 entries, two at one end and one at opposite end, supplied with two M25 polyamide cable glands – 8 to 18.5 mm (0.31 to 0.73") diameter – and one M25 polyamide plug.

Number of Lamps	Power (W)	Lamp Type	Voltage (V)	Weight kg (lbs)	Volume dm ³ (in ³)	Duration (Hours)	Battery Capacity	Catalog Number
2	18	Bi-pin	110/254	7.3 (16.09)	32.3 (1971.07)	3 H	4Ah	FEB218BUTNE
2	36	Bi-pin	110/254	9.6 (21.16)	54.2 (3307.49)	3 H	7Ah	FEB236BUTNE
2	58	Bi-pin	110/254	10.7 (23.59)	65.0 (3966.54)	3 H	7Ah	FEB258BUTNE

Armored Version - Bi-pin (G13):

Two M20 threaded entries with brass earth continuity plate at one end and one M20 threaded entry with brass earth continuity plate at opposite end, supplied with one M20 polyamide plug.

Number of Lamps	Power (W)	Lamp Type	Voltage (V)	Weight kg (lbs)	Volume dm ³ (in ³)	Duration (Hours)	Battery Capacity	Catalog Number
2	18	Bi-pin	110/254	7.3 (16.09)	32.3 (1971.07)	3 H	4Ah	FEB218BUTAE
2	36	Bi-pin	110/254	9.6 (21.16)	54.2 (3307.49)	3 H	7Ah	FEB236BUTAE
2	58	Bi-pin	110/254	10.7 (23.59)	65.0 (3966.54)	3 H	7Ah	FEB258BUTAE

FLUORESCENT/AREA: ATEX/IECEX STANDARD AND EMERGENCY BACK-UP

Appleton®

ATX™ FE Series Nonmetallic Fluorescent Luminaires

Standard and Emergency Battery Back-Up. Increased Safety

ATEX/IECEX:
 Zone 1 and 2 - 21 and 22
 II 2 GD
 IP66/67 – IK10

FLUORESCENT/AREA: ATEX/IECEX STANDARD AND EMERGENCY BACK-UP

Emergency Battery Backup

Surface/Suspension Mounting and Dual Loop In/Out Through Wiring Version (single phase)

Connection via 1 x 4 double deck terminals for 18 W version.

Connection via 1 x 8 terminals and 1 x 4 terminals for 36 W and 58 W versions.

Capacity (flexible/solid): 4 mm²/6 mm² (0.0062 in²/0.0093 in²) – 10/8 AWG.

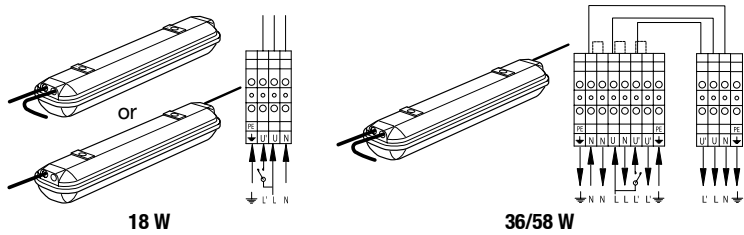

Unarmored Version - Bi-pin (G13)

Three M25 entries, two at one end and one at opposite end, supplied with two M25 polyamide cable glands – 8 to 18.5 mm (0.31 to 0.73") diameter – and one M25 polyamide plug.

Number of Lamps	Power (W)	Lamp Type	Voltage (V)	Weight kg (lbs)	Volume dm ³ (in ³)	Duration (Hours)	Battery Capacity	Catalog Number
2	18	Bi-pin	110/254	7.6 (16.76)	32.3 (1971.07)	3 H	4Ah	FEB218BULNE
2	36	Bi-pin	110/254	9.9 (21.83)	54.2 (3307.49)	3 H	7Ah	FEB236BULNE
2	58	Bi-pin	110/254	10.7 (23.59)	65.0 (3966.54)	3 H	7Ah	FEB258BULNE

Armored Version - Bi-pin (G13)

Two M20 threaded entries with brass earth continuity plate at one end and one M20 threaded entry with brass earth continuity plate at opposite end, supplied with one M20 polyamide plug.

Number of Lamps	Power (W)	Lamp Type	Voltage (V)	Weight kg (lbs)	Volume dm ³ (in ³)	Duration (Hours)	Battery Capacity	Catalog Number
2	18	Bi-pin	110/254	7.6 (16.76)	32.3 (1971.07)	3 H	4Ah	FEB218BULAE
2	36	Bi-pin	110/254	9.9 (21.83)	54.2 (3307.49)	3 H	7Ah	FEB236BULAE
2	58	Bi-pin	110/254	10.7 (23.59)	65.0 (3966.54)	3 H	7Ah	FEB258BULAE

Pole Mounting Version

Connection via 1 x 4 terminals.
 Capacity (flexible/solid): 4 mm²/6 mm² (0.0062 in²/0.0093 in²) – 10/8 AWG.

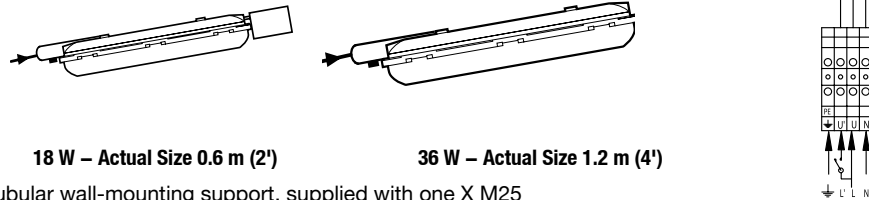

For mounting on diameter 42 mm pole or tubular wall-mounting support, supplied with one X M25 polyamide cable gland – 8 to 18.5 mm (0.31 to 0.73") diameter.





Number of Lamps	Power (W)	Lamp Type	Voltage (V)	Weight kg (lbs)	Volume dm ³ (in ³)	Duration (Hours)	Battery Capacity	Catalog Number
2	18	Bi-pin	110/254	10.0 (22.05)	54.2 (3307.49)	3 H	4Ah	FEB218BUPNE ①
2	36	Bi-pin	110/254	10.4 (22.93)	54.2 (3307.49)	3 H	7Ah	FEB236BUPNE

① 2 x 18 W is supplied with external battery pack (see dimensional data).

ATX™ FE Series Nonmetallic Fluorescent Luminaires

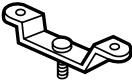
Standard and Emergency Battery Back-Up. Increased Safety

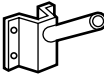
ATEX/IECEX:
 Zone 1 and 2 - 21 and 22
 II 2 GD
 IP66/67 - IK10

Accessories and Replacement Parts		
	Description	Catalog Number
Fixing Brackets		
	Set of two brackets for surface installation Zinc plated steel	FEFBZ
Brackets for Surface Mounting		
	Set of two 316 stainless steel	FESBS
M8 Ring Bolts		
	Set of two Zinc plated steel	FERBM8Z
Half Clamps Brackets for Pole Mounting		
	Set of two Diameter for 1-1/4 to 1-1/2" pole: 42 mm (16.65 in) to 49 mm (1.93 in) Zinc plated steel	FEHC49Z
	316 stainless steel	FEHC49S
	Diameter for 2" pole: 60 mm (2.36 in) Zinc plated steel	FEHC60Z
	316 stainless steel	FEHC60S
Wall Mounting Adaptor		
	For pole mounting version Diameter for 2" pole: 60 mm (2.36 in) Galvanized steel	FEWMG
Hinged Brackets		
	Set of two brackets for adjusting luminaire Aluminium	FEHBA
	316 stainless steel	FEHBS
Fall Prevention Kit		
	Safety chain retains fixture temporarily to ease installation For M25 cable entry	FESCM25
	For M20 cable entry	FESCM20
Adaptor for Fa8 Tube on Fa6 Lampholder		
		096905

FLUORESCENT / AREA: ATEX / IECEX STANDARD AND EMERGENCY BACK-UP



ATX™ FE Series Nonmetallic Fluorescent Luminaires

Standard and Emergency Battery Back-Up. Increased Safety

ATEX/IECEX:
 Zone 1 and 2 - 21 and 22
 II 2 GD
 IP66/67 - IK10

FLUORESCENT/AREA: ATEX/IECEX STANDARD AND EMERGENCY BACK-UP

Wiring Diagram

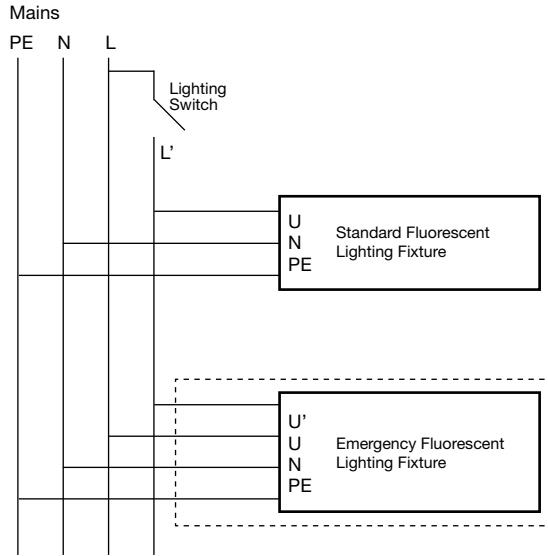

Emergency Function Diagram

Two Lamp Version

Mains	Lighting Switch ON	Lighting Switch OFF
ON		
OFF		

Three Lamp Version

Mains	Lighting Switch ON	Lighting Switch OFF
ON		
OFF		

LED Status

Color	Indication	Function
Green	LED Blinking	Mains good – Battery quick charging
	LED Continuous	Mains good – Battery trickle charging
Red	LED Blinking	No battery connected <i>OR</i> Something is defective
	LED Continuous	Mains faulty – Output ON
	LED Flashing	Mains faulty – Battery empty <i>OR</i> Lamp is defective
Yellow	LED Blinking	Mains good – Performing self test
	LED Continuous	Self test was not okay
None (Off)	No Light Emitted	No mains – Battery completely empty

Emergency Light Duration

Version	Battery Capacity	Duration	Light Output
2 x 18 W	4 Ah – 6 V	90 minute	80%
	4 Ah – 6 V	3 hour	40%
2 x 36 W	7 Ah – 6 V	90 minute	45%
	7 Ah – 6 V	3 hour	25%
2 x 58 W	7 Ah – 6 V	90 minute	30%
	7 Ah – 6 V	3 hour	15%

ATX™ FE Series Nonmetallic Fluorescent Luminaires

Standard and Emergency Battery Back-Up. Increased Safety

ATEX/IECEX:
 Zone 1 and 2 - 21 and 22
 II 2 GD
 IP66/67 - IK10

Dimensions in Millimeters (Inches)

Surface/Suspension Mounting

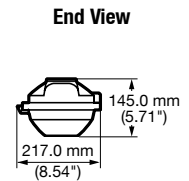
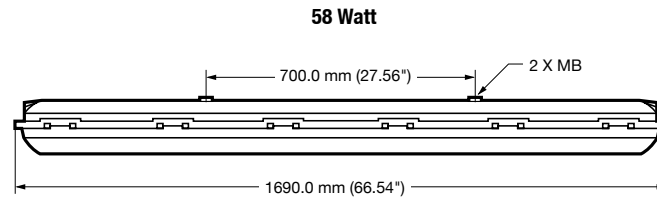
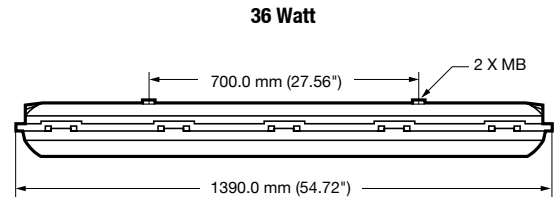
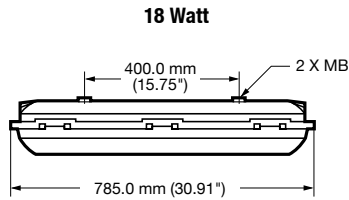

Pole Mounting

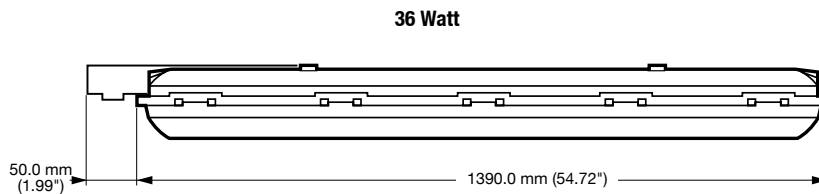
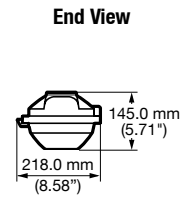
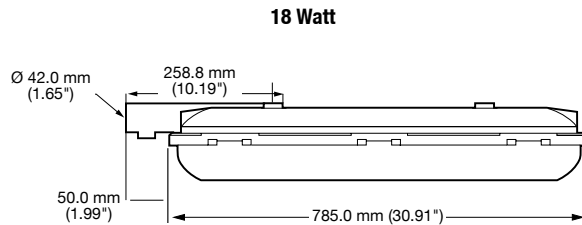

Emergency Pole Mounting

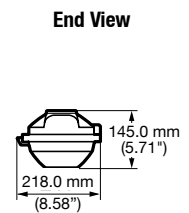
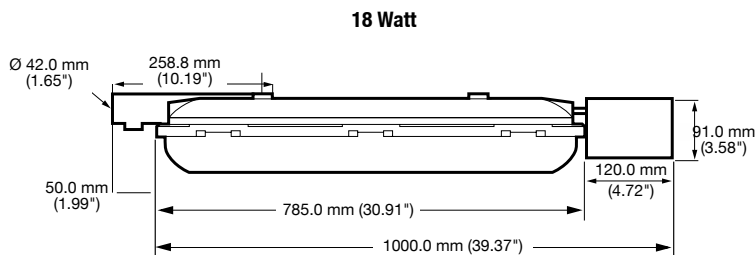

FLUORESCENT / AREA: ATEX / IECEX STANDARD AND EMERGENCY BACK-UP

Appleton

ATX™ FE Series Nonmetallic Fluorescent Luminaires

Standard and Emergency Battery Back-Up. Increased Safety

ATEX/IECEX:
 Zone 1 and 2 - 21 and 22
 II 2 GD
 IP66/67 - IK10

FLUORESCENT/AREA: ATEX/IECEX STANDARD AND EMERGENCY BACK-UP

Mounting Data

FEFBZ: zinc plated steel — Set of two quick fixing brackets for ease of surface mounting

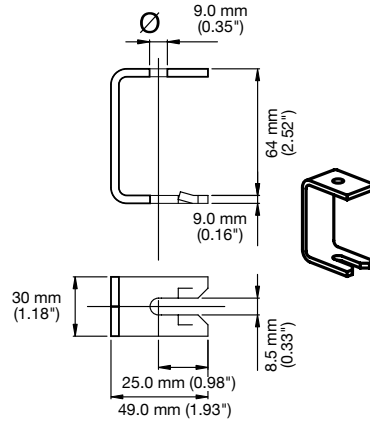

FESBS: 316 stainless steel — Set of two brackets for surface mounting

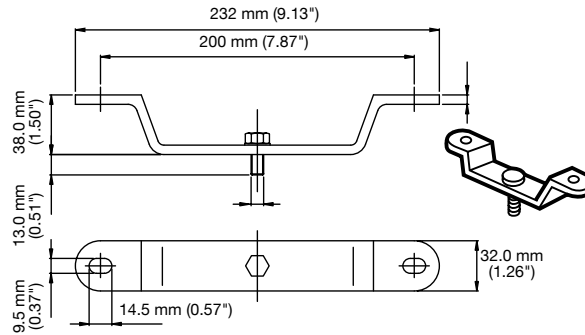

FERBM8Z: zinc plated steel — Set of two ring bolts

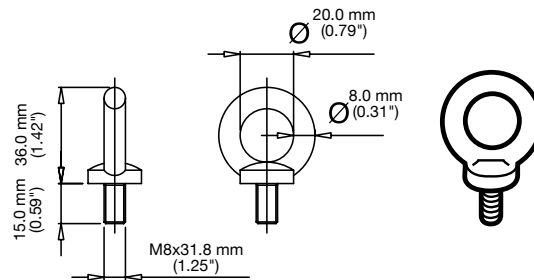

ATX™ FE Series Nonmetallic Fluorescent Luminaires

Standard and Emergency Battery Back-Up. Increased Safety

ATEX/IECEX:
 Zone 1 and 2 - 21 and 22
 II 2 GD
 IP66/67 - IK10

Mounting Data

FEHC49Z: zinc plated steel or FEHC49S: 316 stainless steel — Set of two clamps for pole diameter 42 mm to 49 mm (for 1-1/4" to 1-1/2" pole).
 FEHC60Z: zinc plated steel or FEHC60S: 316 stainless steel — Set of two clamps for pole diameter 60 mm (for 2" pole).

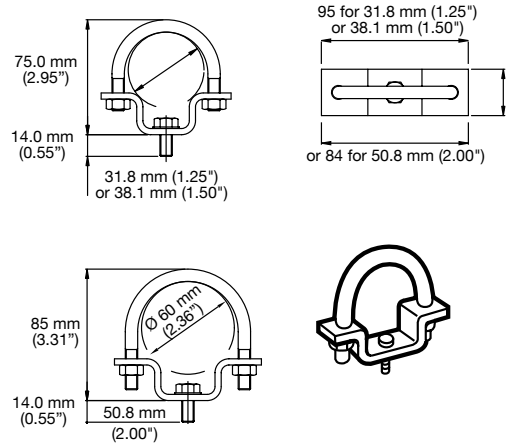
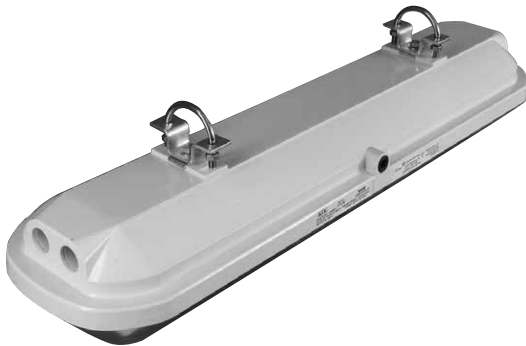

FEWMG: galvanized steel — Wall mounting pole diameter 42 mm (1-1/4")

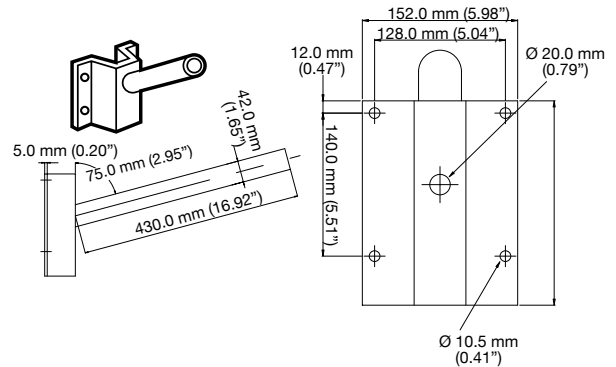

FEHBA: aluminum or FEHBS: 316 stainless steel — Set of two hinged brackets for adjusting luminaire.

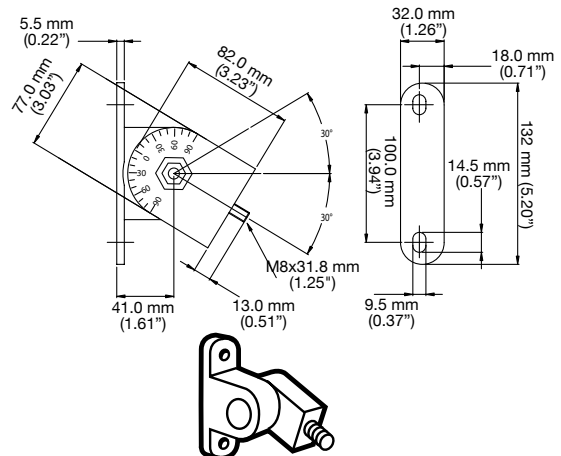

FLUORESCENT / AREA: ATEX / IECEX STANDARD AND EMERGENCY BACK-UP

Appleton

ATX™ FE Series Nonmetallic Fluorescent Luminaires

Standard and Emergency Battery Back-Up. Increased Safety

ATEX/IECEX:
 Zone 1 and 2 - 21 and 22
 II 2 GD
 IP66/67 - IK10

FLUORESCENT/AREA: ATEX/IECEX STANDARD AND EMERGENCY BACK-UP

Photometric Data

Polar curves for a 1000 lm flux, according to NF C 71-120
 Luminaire symbol according to NF C 71-121

--- Longitudinal
 — Transverse

1 x 18 Watt

TOTAL LUMINAIRE EFFICIENCY = 94.8%
 NF C 71-121: 0.86 H + 0.09 T

CANDELA DISTRIBUTION

	0-180	90-270
0	215	215
5	214	214
10	211	215
15	207	213
20	200	211
25	191	209
30	181	208
35	169	202
40	155	196
45	139	187
50	122	181
55	103	175
60	83	174
65	62	173
70	42	165

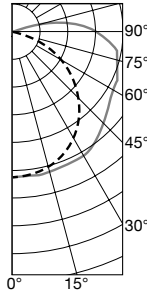

1 x 36 W

Efficiency 89.3%
 NF C 71-121: 0.81 H + 0.08 T

CANDELA DISTRIBUTION

	0-180	90-270
0	205	205
5	204	203
10	202	203
15	197	202
20	191	201
25	182	201
30	173	200
35	161	192
40	148	183
45	133	177
50	117	173
55	99	168
60	80	168
65	61	163
70	41	154

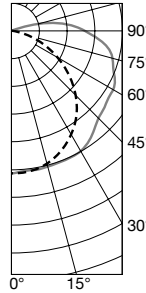

1 x 58 W

Efficiency 87.5%
 NF C 71-121: 0.80 H + 0.07 T

CANDELA DISTRIBUTION

	0-180	90-270
0	198	198
5	197	197
10	194	198
15	190	197
20	184	195
25	176	194
30	166	193
35	155	187
40	142	180
45	128	174
50	113	170
55	96	167
60	78	163
65	59	157
70	41	151

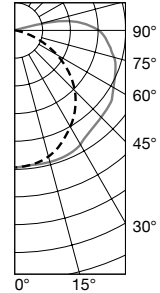

2 x 18 W

Efficiency 85.1%
 NF C 71-121: 0.78 H + 0.08 T

CANDELA DISTRIBUTION

	0-180	90-270
0	195	195
5	195	194
10	192	192
15	187	192
20	181	193
25	173	194
30	163	194
35	152	193
40	138	192
45	124	191
50	108	183
55	91	176
60	73	163
65	55	150
70	37	145

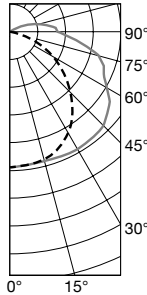

2 x 36 W

Efficiency 80.5%
 NF C 71-121: 0.73 H + 0.07 T

CANDELA DISTRIBUTION

	0-180	90-270
0	185	185
5	185	184
10	182	182
15	178	181
20	172	183
25	164	183
30	154	183
35	143	183
40	131	183
45	117	179
50	102	173
55	85	166
60	68	155
65	51	145
70	35	141

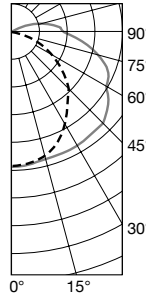

2 x 58 W

Efficiency 76.9%
 NF C 71-121: 0.70 H + 0.07 T

CANDELA DISTRIBUTION

	0-180	90-270
0	173	173
5	172	173
10	170	171
15	166	169
20	161	172
25	154	172
30	145	172
35	135	171
40	123	172
45	111	170
50	97	165
55	82	157
60	66	148
65	50	139
70	34	133

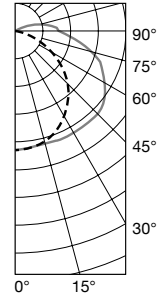

3 x 18 W

Efficiency 68.1%
 NF C 71-121: 0.63 G + 0.05 T

CANDELA DISTRIBUTION

	0-180	90-270
0	173	173
5	172	172
10	169	170
15	135	169
20	160	169
25	153	168
30	144	167
35	135	162
40	123	158
45	110	153
50	96	146
55	82	136
60	66	123
65	50	111
70	34	100

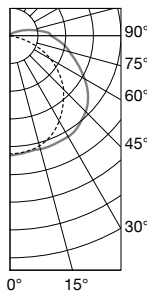

3 x 36 W

Efficiency 68.1%
 NF C 71-121: 0.63 G + 0.07 T

CANDELA DISTRIBUTION

	0-180	90-270
0	174	174
5	174	174
10	171	173
15	167	171
20	162	171
25	155	170
30	146	168
35	136	163
40	125	159
45	112	153
50	98	145
55	83	135
60	67	123
65	51	110
70	35	100

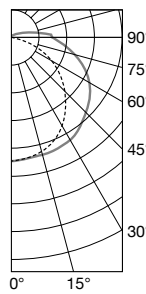

3 x 58 W

Efficiency 65.6%
 NF C 71-121: 0.61 H + 0.04 T

CANDELA DISTRIBUTION

	0-180	90-270
0	170	170
5	170	170
10	167	168
15	163	169
20	158	167
25	151	167
30	143	163
35	133	159
40	122	155
45	109	149
50	95	140
55	81	129
60	65	116
65	49	105
70	33	96

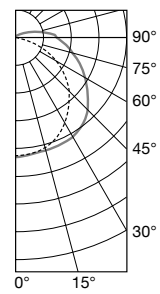

ATX™ FDES Series Self-Contained Emergency Lighting Units

Flameproof. Fluorescent

ATEX/IECEX:
Zone 1 and 2 - 21 and 22
Ⓜ II 2 GD
IP66/68 - IK08

Applications

- Provides adequate lighting and/or visual indication of access on exit routes during an emergency evacuation in a hazardous environment.
- Can be installed in hazardous areas designated as Zone 1 and 2 – 21 and 22.
- Typical applications include oil refineries, petrochemical plants, pulp and paper mills.

Features

- Power supply from 110 to 240 Vac 50/60 Hz versions.
- 3-hour duration.
- Threaded access cover with O-ring seal.
- Operates in any position.
- 8 W Fluorescent (1 or 2 lamps supplied).
- Charge indicator by 1 red LED (life time over 10 years).
- Termination 3 or 4 x 2.5 mm² (0.005 or 0.006 x 0.004 in²) terminals.
- Supplied with two fixing lugs.

Standard Materials

- End caps and cover: aluminum
- O-ring seal: Nitrile
- Lens: tempered borosilicate glass
- Fixing brackets: zinc plated steel or 316 stainless steel
- Accessories: white painted galvanized steel
- Guard: zinc plated steel

ATEX/IECEX Certifications and Compliances

- Certification Type: FLd
 - Gas: Zone 1 - 2
 - Conforming to ATEX 94/9/CE: Ⓜ II 2 G
 - Type of Protection: Ex d IIC
 - Temperature Class: T6
 - Dust: Zone 21 - 22
 - Conforming to ATEX 94/9/CE: Ⓜ II 2 D
 - Type of Protection: Ex tD A21
 - Surface Temperature: T80 °C (T176 °F)
- Ambient Temperature: -40 °C to +55 °C (-40 °F to +131 °F)
- CE Declaration of Conformity: 50203
- ATEX Certificate: LCIE 97/ ATEX 6012
- IECEx Certificate: IECEx LCI 04.0018
- Index of Protection according EN/IEC 60529: IP66/68
- Impact Resistance (shock): IK08
- Internal Volume: > 2 dm³ (122 in³) - 2 liters

EURASEC Certification

- EURASEC N° TC RU C-FR.Г505.B.00912

Other Certification

- INMETRO Certificate: BVC11.0492 ①



2 x 8 W Fluorescent Sustained

FLUORESCENT/EMERGENCY: ATEX/IECEX INCREASED SAFETY

Appleton®

① Inmetro certification available on special request only. Contact your local sales representative for more information.

ATX™ FDES Series Self-Contained Emergency Lighting Units

Flameproof. Fluorescent

ATEX/IECEX:
 Zone 1 and 2 - 21 and 22
 II 2 GD
 IP66/68 - IK08

Order using catalog numbering guide below or select catalog number from tables on following pages.

Catalog Numbering Guide – FDES Series Self-Contained Emergency Units

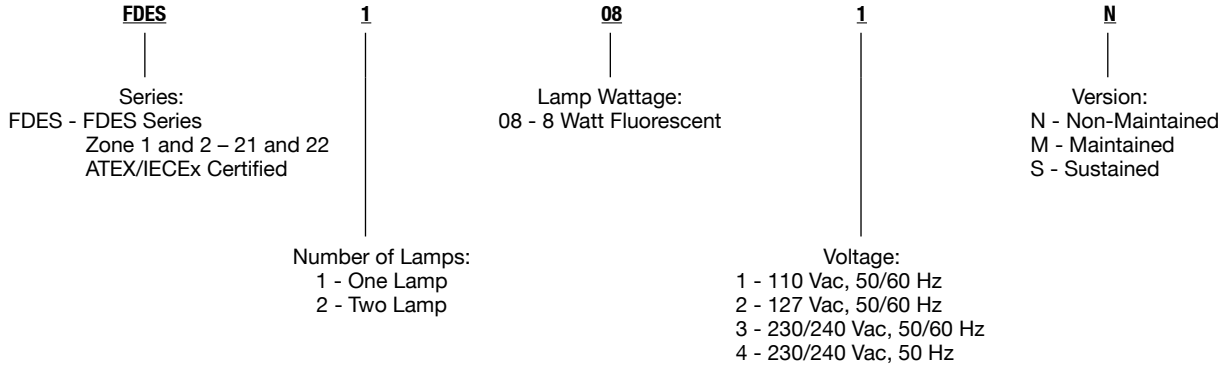

3 Hour Duration – Two M20 Threaded Cable Entries With One M20 Blanking Plug

Type	Lumen Output	Voltage	Frequency	Weight kg (lb)	Volume dm ³ (in ³)	Catalog Number
1 x 8 W Fluorescent Non-Maintained	230 lm	230/240 Vac	50/60 Hz	7.8 (17.20)	36 (2196.9)	FDES1083N
		127 Vac	50/60 Hz			FDES1082N
		110 Vac	50/60 Hz			FDES1081N
		220 Vac	60 Hz			—
1 x 8 W Fluorescent Maintained	180 lm	230/240 Vac	50/60 Hz	7.8 (17.20)	36 (2196.9)	FDES1084M
		127 Vac	50/60 Hz			FDES1082M
		110 Vac	50/60 Hz			FDES1081M
		220 Vac	60 Hz			—
2 x 8 W Fluorescent Sustained	230 lm	230/240 Vac	50 Hz	7.8 (17.20)	36 (2196.9)	FDES2084S
		220 Vac	60 Hz			—







FLUORESCENT/EMERGENCY: ATEX/IECEX INCREASED SAFETY

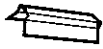

ATX™ FDES Series Self-Contained Emergency Lighting Units

Flameproof. Fluorescent

ATEX/IECEX:
 Zone 1 and 2 - 21 and 22
 II 2 GD
 IP66/68 - IK08

Accessories and Replacement Parts		
	Description	Catalog Number
	Reflector White painted galvanized steel	FDER1G
	Protective Guard Zinc plated steel	FDPG1Z
	Fixing Brackets: Set of two for ease of surface installation Zinc plated steel 316 stainless steel	FDFBZ FDFBS
	Surface Mounting Brackets: Set of two Zinc plated steel 316 stainless steel	FDSBZ FDSBS
	Half Clamps: Set of two Zinc plated steel versions: Diameter for 1-1/4 to 1-1/2" pole: 42 mm (16.65 in) to 49 mm (1.93 in) Diameter for 2" pole: 60 mm (2.36 in) 316 stainless steel versions: Diameter for 1-1/4 to 1-1/2" pole: 42 mm (16.65 in) to 49 mm (1.93 in) Diameter for 2" pole: 60 mm (2.36 in)	FDHC49Z FDHC60Z FDHC49S FDHC60S
	Spare Lamps 8 W fluorescent G5	LF008G5
	Fall Prevention Kit 1.20 m (3.94 ft) stainless steel chain	FDSCS

FLUORESCENT/EMERGENCY: ATEX/IECEX INCREASED SAFETY

Appleton®

ATX™ FDES Series Self-Contained Emergency Lighting Units

Flameproof. Fluorescent

ATEX/IECEX:
 Zone 1 and 2 - 21 and 22
 II 2 GD
 IP66/68 - IK08

Electrical Wiring Diagram

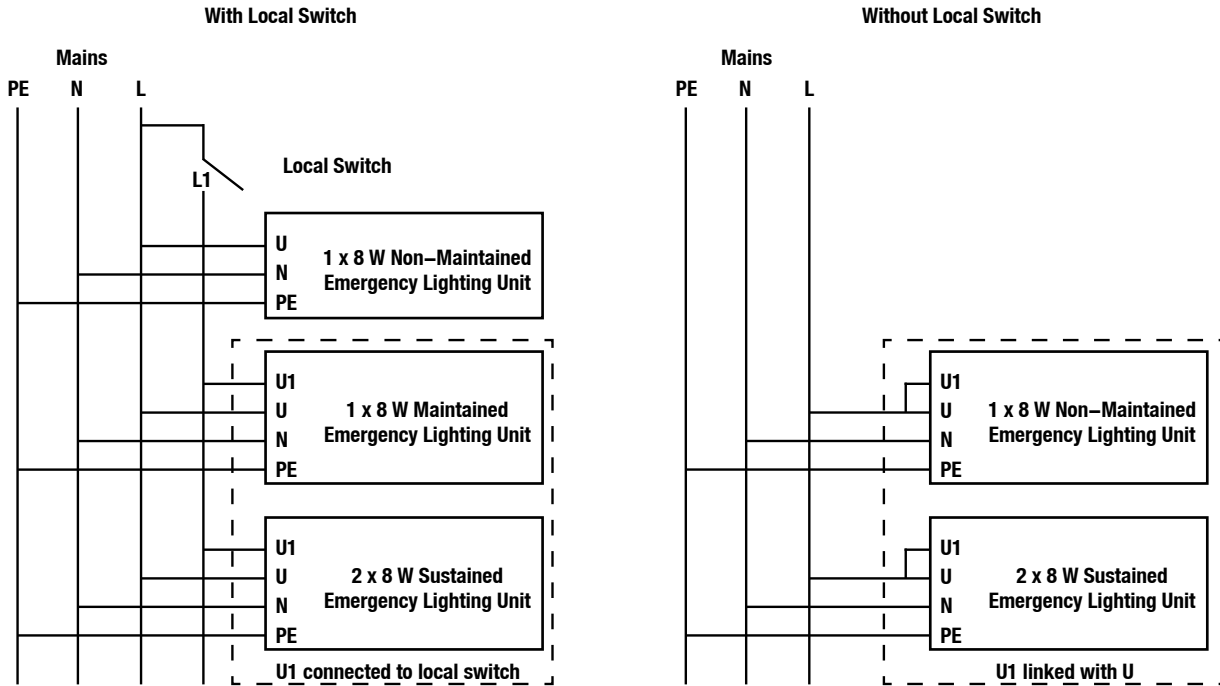

Emergency Function Diagram

Mains	1 x 8 W Maintained			2 x 8 W Sustained	
	1 x 8 W Non-Maintained	Local Switch OFF or No Link	Local Switch ON or Link Present	Local Switch OFF or No Link	Local Switch ON or Link Present
Switched ON					
Switched OFF					

Dimensions in Millimeters (Inches)

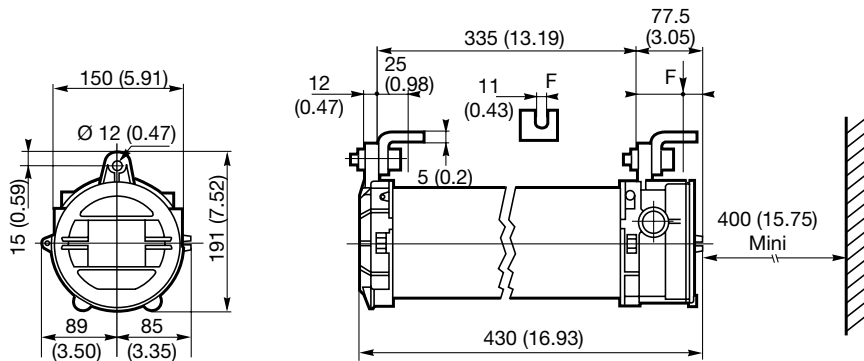

FLUORESCENT/EMERGENCY: ATEX/IECEX INCREASED SAFETY

Appleton®

Stylmaster™ Strobe Luminaires

Enclosed and Gasketed

NEC: Pendant Mount
Class I, Division 2, Groups A, B, C, D
Class II, Division 1 and 2, Groups E, F, G
Class III
NEMA 3R, 4
Marine Outside Type (Saltwater)

NEC: Ceiling and Wall Bracket Mount
Class I, Division 2, Groups A, B, C, D
NEMA 3R, 4

CEC:
Class I, Division 2, Groups A, B, C, D
Class II, Division 1 and 2, Groups E, F, G
Class III
CSA Enclosure 3

Applications

- Enclosed and gasketed fixtures suitable for use in:
 - Marine and wet locations
 - Industrial processing
 - Chemical processing
 - Areas where flammable gases and vapors are present under conditions defined by NEC Class I, Division 2; Class II, Division 1 and 2; and Class III
- For use in areas where audible signals cannot be heard.
- Used to warn of unsafe conditions and other communication needs.
- Fixtures are also suited for use in non-hazardous areas where there are:
 - Severe weather conditions
 - Excessive moisture, dirt, dust
 - Corrosive atmospheres
 - High ambient temperatures are encountered
- Typical applications include:
 - Pulp and paper mills
 - Processing plants
 - Chemical plants
 - Oil refineries
 - Foundries
 - Manufacturing plants
 - Storage areas
 - Marine applications

Features

- Modern styling, with clean-line mounting hood and prismatic glass globe, plus optional guard.
- Globe seats firmly against silicone gasket in mounting hood to keep out dirt and moisture. Full threads eliminate “cross threading.”
- Optional guard protects glass from damage and has exclusive snap-on attachment feature for quick installation and fast servicing.
- Fixtures operate safely in high ambient temperatures.
- Strobe: 65 flashes per minute. 800,000 peak candlepower.
- Fixtures are complete with lamp.
- Lens available in five colors: red, amber, blue, green and clear (factory installed).
- Heat- and impact-resistant globes have smooth dust-resistant exterior.
- Fixture is suitable for mounting globe up or globe down utilizing pendant, ceiling or wall bracket type mounts.
- Minimum operating temperature is -25 °C (-13 °F).

Standard Materials

- Mounting hoods: copperfree (4/10 of 1% max.) aluminum
- Guards: pressure cast copperfree (4/10 of 1% max.) aluminum
- Globes: prismatic glass

Standard Finish

- Mounting hoods and guards: powder coat epoxy

NEC/CEC Certifications and Compliances

- UL Standard: UL 1203, UL 1638
- UL Listed: E207738
- CSA Standard: C22.2 No. 25
- cUL Listed: E207738



Fixtures are suitable for mounting in any position – including globe up or globe down – utilizing pendant, ceiling or wall bracket type mounts.

Stylmaster™ Strobe Luminaires

Enclosed and Gasketed

NEC: Pendant Mount
 Class I, Division 2, Groups A, B, C, D
 Class II, Division 1 and 2, Groups E, F, G
 Class III
 NEMA 3R, 4
 Marine Outside Type (Saltwater)

NEC: Ceiling and Wall Bracket Mount
 Class I, Division 2, Groups A, B, C, D
 NEMA 3R, 4

CEC:
 Class I, Division 2, Groups A, B, C, D
 Class II, Division 1 and 2, Groups E, F, G
 Class III
 CSA Enclosure 3

Order using catalog numbering guide below or select catalog number from tables on following pages.

Catalog Numbering Guide For VP Stylmaster Strobe Luminaires

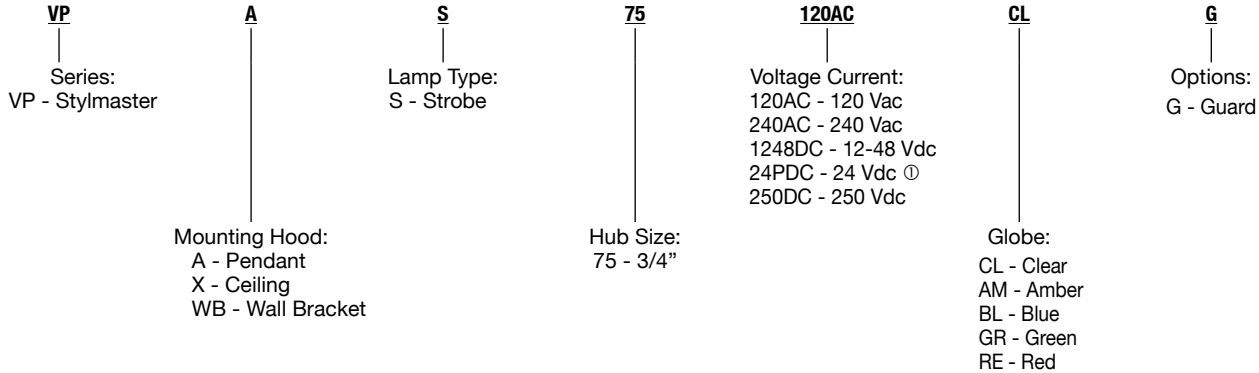

Technical Data: Thermal Suitability of Stylmaster Strobe

Operating Temperatures

Ambient Temp. °C (°F)	Class I, Division 2 Groups A,B,C,D Pendant, Ceiling and Wall Bracket	Class II, Division 1 and 2 and Class III Pendant Mount
40 (104)	T2A	T4A
55 (131)	T2	T4A
65 (149)	T1	T4

Operating Temperatures Represent the Maximum Internal Temperature for Class I, Division 2 Locations and Maximum Surface Temperature Under Dust Blanket for Class II, Division 1 Locations.

"T" Number	T1	350	325	T2	T2A	T2B	T2C	T2D	T3	T3A	T3B	T3C	T4	T4A	T5	T6
Temp Range (°C)	351-450	326-350	301-325	281-300	261-280	231-260	216-230	201-215	181-200	166-180	161-165	136-160	121-135	101-120	86-100	85
Temp. Range (°F)	664-842	619-662	574-617	538-572	502-536	448-500	421-446	394-419	358-392	331-356	322-329	277-320	250-275	214-248	187-212	185

NOTE: The maximum operating temperature of the fixture must not exceed the ignition temperature of the gas, vapor or dust to be encountered per the National Electrical Code and the Canadian Electrical Code.

① Diode Polarized (current limiter supplied as standard).





Stylmaster™ Strobe Luminaires

Enclosed and Gasketed

NEC: Pendant Mount
 Class I, Division 2, Groups A, B, C, D
 Class II, Division 1 and 2, Groups E, F, G
 Class III
 NEMA 3R, 4
 Marine Outside Type (Saltwater)

NEC: Ceiling and Wall Bracket Mount
 Class I, Division 2, Groups A, B, C, D
 NEMA 3R, 4

CEC:
 Class I, Division 2, Groups A, B, C, D
 Class II, Division 1 and 2, Groups E, F, G
 Class III
 CSA Enclosure 3

	Volts	Wt. kg (lb)	Catalog Number ①
Pendant — Rigid Conduit One Hub 3/4" NPT			
	120 Vac	2.0 (4.41)	VPAS75120ACCL
	240 Vac		VPAS75240ACCL
	250 Vdc		VPAS75250DCCL
	12-48 Vdc		VPAS751248DCCL
	24 Vdc		VPAS7524PDCCL ②
Ceiling — Rigid Conduit Four Hubs 3/4" NPT Three Close-Up Plugs			
	120 Vac	2.4 (5.29)	VPXS75120ACCL
	240 Vac		VPXS75240ACCL
	250 Vdc		VPXS75250DCCL
	12-48 Vdc		VPXS751248DCCL
	24 Vdc		VPXS7524PDCCL ②
Wall Bracket — Rigid Conduit Four Hubs 3/4" NPT Three Close-Up Plugs			
	120 Vac	2.9 (6.39)	VPWBS75120ACCL
	240 Vac		VPWBS75240ACCL
	250 Vdc		VPWBS75250DCCL
	12-48 Vdc		VPWBS751248DCCL
	24 Vdc		VPWBS7524DCCL ②
Optional Aluminum Guard			
		0.5 (1.10)	VPGU-1

① Catalog numbers shown are supplied with clear lens. To order colored lens, replace the last digits of catalog number **CL** with **AM** for amber, **BL** for blue, **GR** for green or **RE** for red.
 ② Diode Polarized (current limiter supplied as standard).

Stylmaster™ Strobe Luminaires

Enclosed and Gasketed

NEC: Pendant Mount
 Class I, Division 2, Groups A, B, C, D
 Class II, Division 1 and 2, Groups E, F, G
 Class III
 NEMA 3R, 4
 Marine Outside Type (Saltwater)

NEC: Ceiling and Wall Bracket Mount
 Class I, Division 2, Groups A, B, C, D
 NEMA 3R, 4

CEC:
 Class I, Division 2, Groups A, B, C, D
 Class II, Division 1 and 2, Groups E, F, G
 Class III
 CSA Enclosure 3

Replacement Parts

	Fixture Type	Lamp Type	Voltage	Base Type	Catalog Number
Replacement Lamps	Strobe	Xenon	All	Octal Socket	S865

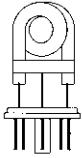

S865

	Glass Globe	Catalog Number
Replacement Globes and Inserts	Clear	VPGL-1HR



Dimensions in Millimeters (Inches)

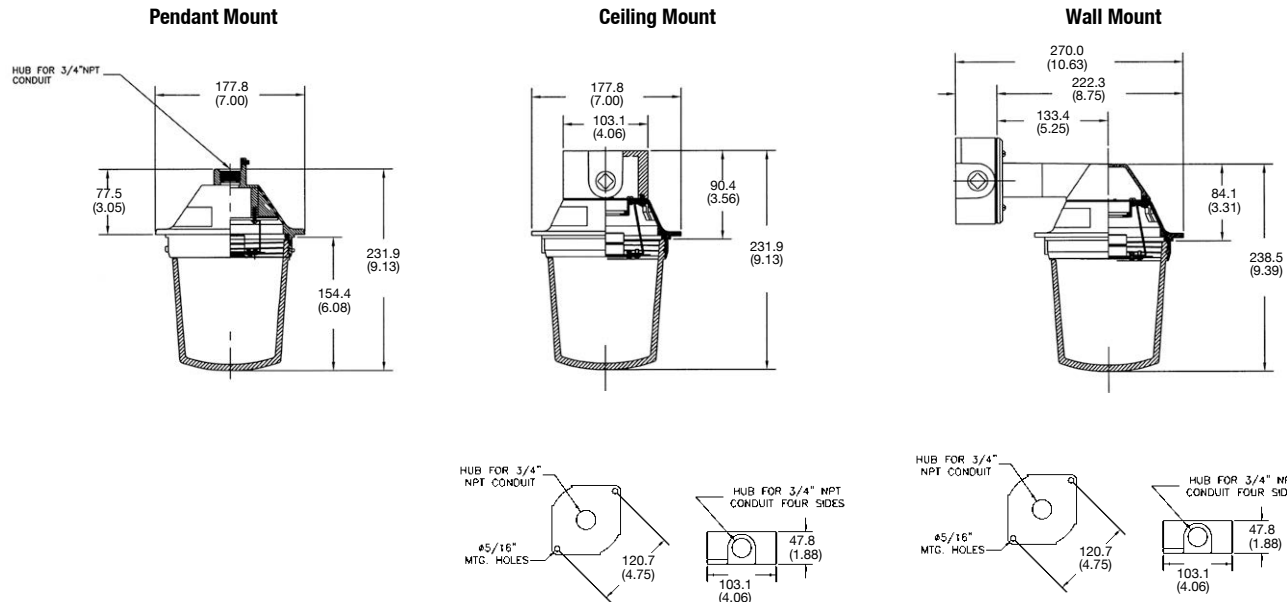

TVA Obstruction, Approach and Boundary Luminaires

For use with Threaded Rigid Metal Conduit and IMC.

CEC:
Listed for Ordinary (Unclassified) Locations

CEC –Optional:
Class I, Division 2 versions are available

Applications

- Transport Canada approved TVA490 series low intensity obstruction, approach or boundary light.
- TVA490 series obstruction lights are suitable for use on communication towers or other tall structures and buildings.

Features

- TVA obstruction lights are available with one or two lamps.
- Models are equipped with rainports in the globe holder which keeps the wiring chamber dry.
- TVA obstruction lights are rugged cast aluminum construction.
- Two lamp fixtures are furnished with pre-wired sockets.
- Utilizes Type A-21, 116 W clear traffic signal lamp.
- A corrosion resistant finish protects TVA fixtures. TVA490 obstruction lights are approved for use by Transport Canada.
- Engineered for easy and safe maintenance, TVA490 fixtures are serviced without tools:
 - (1) The globe holder is secured with a captive thumb screw
 - (2) a one-eighth turn twist removes the globe and globe holder
 - (3) the assembly is hung from a safety chain freeing both hands
- Fresnel glass lenses and three lamp holder positions permit use of TVA490 fixtures on structures below 15.2 meters (50 feet), from 15.2 to 30.5 meters (50 to 100 feet), and over 100 feet/30.5 meters.
- A plugged 1" side hub and a 1-1/4" bottom hub provide conduit entry.
- Transfer and failure alarm relays for both one and two lamp fixtures.
- Pilot light assembly contains a red pilot light to indicate lamp failure.

Standard Materials

- TVA bodies: copperfree (4/10 of 1% max.) aluminum
- Lamp holders: porcelain
- Transfer and failure alarm, pilot light assembly: ferrous alloy enclosure
- Supply wire requirement: +90 °C (+194 °F)

Standard Finish

- TVA490: international orange epoxy clad finish
- Transfer failure alarm, pilot light assembly: triple coat – (1) zinc electroplate, (2) chromate and (3) aluminum polymer enamel

Options

- Class I, Division 2 versions are available. Contact your local sales representative for details.

CEC Certifications and Compliances

- CSA Standard: C22.2 No. 250
- CSA Certified: 009349



TVA 1490

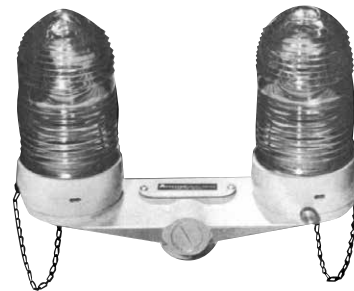

TVA 2490

TVA Obstruction, Approach and Boundary Luminaires









For use with Threaded Rigid Metal Conduit and IMC.

CEC:
Listed for Ordinary (Unclassified) Locations

CEC -Optional:
Class I, Division 2 versions are available

Appleton

VISUAL SIGNAL: NEC/CEC ENCLOSED AND GASKETED

Description	Hub Size (Inches)		Catalog Number	
	Side	Bottom		
TVA490 Obstruction, Approach and Boundary Lights				
Type A-21 Clear Traffic Signal Light 116 W				
One Lamp Fixtures				
	Obstruction with Red Globe	—	1	TVA1490
	Approach with Yellow Globe	—	1	TVA1490Y
	Boundary with Clear Globe	—	1	TVA1490C
One Lamp Haz. Loc. Fixtures				
	Obstruction with Red Globe	—	1	TVA1490H
	Approach with Yellow Globe	—	1	TVA1490YH
	Boundary with Clear Globe	—	1	TVA1490CH
Two Lamp Fixtures				
	Obstruction with Red Globe	1	1-1/4 ①	TVA2490
	Approach with Yellow Globe	1	1-1/4 ①	TVA2490Y
	Boundary with Clear Globe	1	1-1/4 ①	TVA2490C
Two Lamp Haz. Loc. Fixtures				
	Obstruction with Red Globe	1	1-1/4 ①	TVA2490H
	Approach with Yellow Globe	1	1-1/4 ①	TVA2490YH
	Boundary with Clear Globe	1	1-1/4 ①	TVA2490CH
TVA490 Replacement Parts				
Mounting Fittings				
	With Globe Holder and Lamp Socket			
	Single Lamp	—	1	TVA1400
	Two Lamp	1	1-1/4	TVA2400
Globes				
	Fresnel			
	Red			V-990R
	Aviation yellow			V-990Y
	Clear			V-990C
Lamp Socket				
	Porcelain — Medium Base			V-1025
Globe Gasket				
	Neoprene			V-2055G
Wiring Chamber Cover				
	Cover assembly for two lamp fixture wiring chamber. With gasket and screws			V-2010





① To order with 1/4" to 1" reducer in the bottom hub add suffix **-RB100**.

TVA Obstruction, Approach and Boundary Luminaires

For use with Threaded Rigid Metal Conduit and IMC.

CEC:
Listed for Ordinary (Unclassified) Locations

CEC –Optional:
Class I, Division 2 versions are available

	Description	Hub Size (Inches)	Catalog Number
Lamp Failure Alarm		<p>In the event of both lamps failing in the obstruction light an alarm circuit is triggered. Weather-proof enclosure is furnished with feed-thru hubs. 120 Vac, 50/60 Hz Relay drops out at 0.6 amps.</p>	<p>1 FDC-32R2</p>
Transfer Relay and Lamp Failure Alarm		<p>In the event of a lamp failure, power is transferred to the standby lamp and an alarm circuit is activated. Weather-proof enclosure is furnished with feed-thru hubs. 120 Vac, 50/60 Hz Relay drops out at 0.6 amps.</p>	<p>1 FDC-32R1</p>
Pilot Light Assembly		<p>Connected to failure alarm to indicate lamp failure. Red pilot light. 6S6 candelabra base lampholder. Dead end enclosure.</p>	<p>1 FD-3J1</p>
Photocell		<p>(Non-Hazardous) Comes installed in FDO type enclosure, ready for installation. 120 V Only.</p>	<p>FS601</p>
		<p>(Class I, Division 2) As above, c/w Encapsulated Photocell for Hazardous Area installation. 120 V Only.</p>	<p>FS601D2</p>
Flasher Assembly		<p>Comes installed in FDO type enclosure, ready for installation. 2500 W Rated, 200 A Max. In-Rush FAA approved 30 FPM Flash Rate.</p>	<p>TVA-FL</p>

TVA Obstruction, Approach and Boundary Luminaires

For use with Threaded Rigid Metal Conduit and IMC.

CEC:
Listed for Ordinary (Unclassified) Locations

CEC -Optional:
Class I, Division 2 versions are available

Appleton

VISUAL SIGNAL: NEC/CEC ENCLOSED AND GASKETED

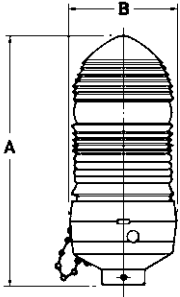
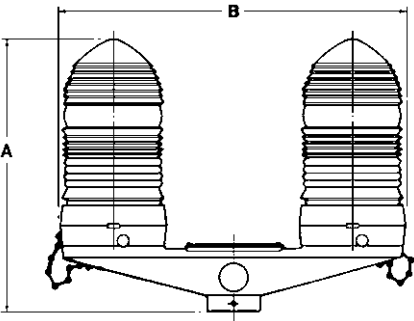
Description	Dimensions in Millimeters (Inches)		Catalog Number	
	A	B		
One Lamp 	Single	254.0 (10.00)	107.95 (4.25)	TVA1490
Two Lamp 	Twin	273.05 (10.75)	349.25 (13.75)	TVA2490

Code•Master™ Factory Sealed Strobe Luminaires

Explosionproof, Dust-Ignitionproof

NEC:

Class I, Division 1 and 2, Groups C, D
Class I, Division 2, Groups A, B
Class II, Division 1 and 2, Groups E, F, G
Class III
NEMA 3R, 4X

NEC:

Suitable for Wet Locations
Marine Outside Type (Saltwater)

Applications

- Code•Master Explosionproof Strobe fixtures are designed to provide safe operation in the presence of hazardous gases, vapors or dusts, defined by the National Electrical Code as Class I, Groups C and D; and Class II, Groups E, F and G.
- For use in hazardous locations such as plants where plastics, paints, thinners and petrochemicals are manufactured.
- Also used in areas where audible signals cannot be heard, to warn of unsafe conditions and for other communication needs.

Features

- Fixtures operate safely in high ambient temperatures.
- Minimum operating temperature is -25 °C (-13 °F).
- Available for fire alarm hearing impaired.
- 65 flashes per minute.
- Fixtures are complete with lamp.
- Patented “wireless” design. Threading of fixture unit onto mounting hood makes electrical connection. The only wiring required is attaching two wires to connection block in mounting hood.
- Connection block is easily wired: (a) loosen two screws, (b) make wire connections; and (c) re-position connection block.
- Safe, easy servicing without disconnecting any wiring. “Wireless” fixture unit threads off mounting hood for convenient servicing or for immediate replacement with a “stand by” unit.
- Acme double lead threads speed installation and fixture removal from mounting hood. Only half as many turns are required as for single lead threads. The threads do not stick or gall, eliminating problems often encountered with single lead threads during fixture unit removal.
- All threaded joints are flame-tight.
- Factory installed lens available in five colors: red, amber, blue, green and clear (factory installed).
- Factory sealed. External seals are not required.
- Heat- and impact-resistant globes have smooth dust-resistant exterior.
- Fixture is suitable for mounting globe up or globe down utilizing pendant, ceiling or wall bracket type mounts.
- Optional guards protect globes from damage.

Standard Materials

- Fixture housing, mounting hoods and guards: copperfree (4/10 of 1% max.) aluminum
- Globes: prismatic glass
- Screws: Stainless steel (3)

Standard Finishes

- Fixture housing, guards and mounting hoods: epoxy power coat finish, electrostatically applied for complete, uniform corrosion protection

NEC Certifications and Compliances

- UL Listed: E212210
- UL Standard: 1203
- UL Standard: 1638 Visual Signaling Appliances
- UL Standard: 1971 Visual Signaling Equipment has been investigated for fire protective signaling services to alert hearing impaired persons. This signaling equipment is intended to be used in conjunction with Listed compatible units and devices. Visual signaling equipment Listed in this category is intended to be used in the “Public Operating Mode” as defined in NFPA 72



Fixture (shown with optional guard) are suitable for mounting in any position including globe up or globe down utilizing pendant, ceiling or wall-bracket type mounts.

Appleton®

VISUAL SIGNAL: NEC/CEC EXPLOSIONPROOF

Code•Master™ Factory Sealed Strobe Luminaires

Explosionproof, Dust-Ignitionproof

NEC:
 Class I, Division 1 and 2, Groups C, D
 Class I, Division 2, Groups A, B
 Class II, Division 1 and 2, Groups E, F, G
 Class III
 NEMA 3R, 4X

NEC:
 Suitable for Wet Locations
 Marine Outside Type (Saltwater)

Ordering Information

Order using catalog numbering guide below or select catalog number from tables on following pages.

Catalog Numbering Guide

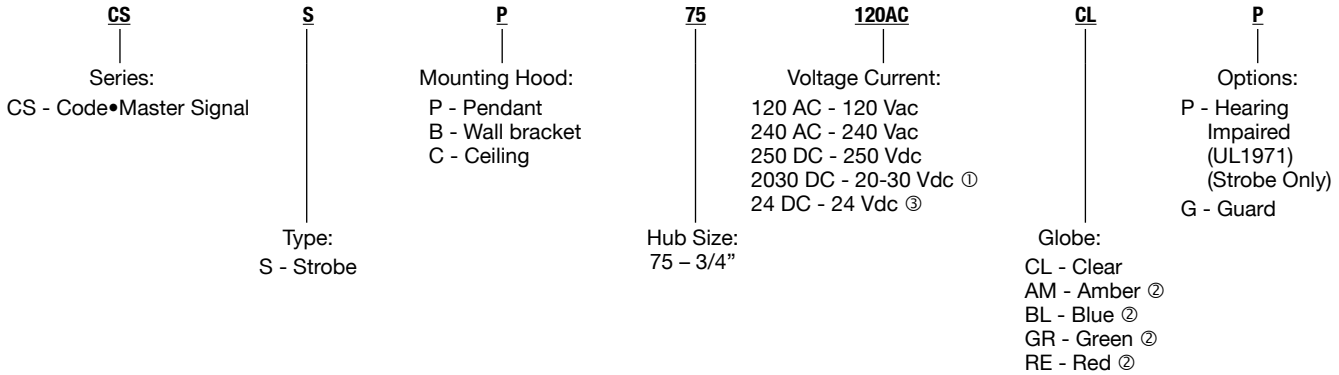

Thermal Suitability of Code-Master Strobe Fixture

Ambient Temp. °C (°F)	Class I, Division 1 and 2 Groups C and D	Class I, Division 2 Groups A and B	Class II, Division 1 and 2 Class III
40 (104)	T6	T2B	T4A
55 (131)	T6	T2B	T4A
65 (149)	T6	T2A	T4

Operating Temperatures

"T" Numbers Represent the Maximum Internal Temperature for Class I, Division 2 Locations; Maximum Surface Temperature for Class I, Division 1 Locations; and Maximum Surface Temperature Under Dust Blanket for Class II, Division 1 Locations.

"T" Number	T1	350	325	T2	T2A	T2B	T2C	T2D	T3	T3A	T3B	T3C	T4	T4A	T5	T6
Temp. Range (°C)	351-450	326-350	301-325	281-300	261-280	231-260	216-230	201-215	181-200	166-180	161-165	136-160	121-135	101-120	86-100	85
Temp. Range (°F)	664-842	619-662	574-617	538-572	502-536	448-500	421-446	394-419	358-392	331-356	322-329	277-320	250-275	214-248	187-212	185

NOTE: The maximum operating temperature of the fixture must not exceed the ignition temperature of the gas, vapor or dust to be encountered per the National Electrical Code.







① UL1971: Hearing-Impaired Strobe Only
 ② Not for use with UL1971 Strobe
 ③ Diode Polarized (Current limiter supplied as standard).

Code•Master™ Factory Sealed Strobe Luminaires

Explosionproof, Dust-Ignitionproof

NEC:
 Class I, Division 1 and 2, Groups C, D
 Class I, Division 2, Groups A, B
 Class II, Division 1 and 2, Groups E, F, G
 Class III
 NEMA 3R, 4X

NEC:
 Suitable for Wet Locations
 Marine Outside Type (Saltwater)

Standard Strobes		Volts	Catalog Number ①③
Pendant — One Hub 3/4" NPT, Rigid Conduit			
		120 Vac	CSSP75120ACCL
		240 Vac	CSSP75240ACCL
		250 Vdc	CSSP75250DCCL
		24 Vdc	CSSP7524DCCL ②
Ceiling — Four Hubs 3/4" NPT, Three Close-Up Plugs, Rigid Conduit			
		120 Vac	CSSC75120ACCL
		240 Vac	CSSC75240ACCL
		250 Vdc	CSSC75250DCCL
		24 Vdc	CSSC7524DCCL ②
Bracket — Four Hubs 3/4" NPT, Three Close-Up Plugs, Rigid Conduit			
		120 Vac	CSSB75120ACCL
		240 Vac	CSSB75240ACCL
		250 Vdc	CSSB75250DCCL
		24 Vdc	CSSB7524DCCL ②
Fixture Unit Only — Less Mounting Hood			
		120 Vac	CSST120ACCL
	10.36 kg (4.7 lb)	240 Vac	CSST240ACCL
		250 Vdc	CSST250DCCL
		24 Vdc	CSST24DCCL ②
	Weight kg (lb)	Hub Size (Inches)	Catalog Number
Pendant Mounting Hood — One Hub 3/4" NPT, Rigid Conduit			
	9.0 (19.84)	3/4	CAP-75
Ceiling Mounting Hood — Four Hubs 3/4" NPT, Three Close-Up Plugs, Rigid Conduit			
	1.8 (3.97)	3/4	CAC-75
Bracket Mounting Hood — Four Hubs 3/4" NPT, Three Close-Up Plugs, Rigid Conduit			
	2.7 (5.95)	3/4	CALB-75

① Add -G suffix for optional guard.

② Diode polarized (current limiter supplied as standard).

③ Catalog numbers shown are supplied with clear lens. To order colored lens, replace last digits of catalog number CL with AM for amber; BL for blue; GR for green; and RE for red.







Code•Master™ Factory Sealed Strobe Luminaires

Explosionproof, Dust-Ignitionproof

NEC:
 Class I, Division 1 and 2, Groups C, D
 Class I, Division 2, Groups A, B
 Class II, Division 1 and 2, Groups E, F, G
 Class III
 NEMA 3R, 4X

NEC:
 Suitable for Wet Locations
 Marine Outside Type (Saltwater)

Strobes for the Hearing Impaired

	Type Mounting	Volts	Catalog Number — UL1971: Hearing-Impaired ①
Pendant — One Hub 3/4" NPT, Rigid Conduit			
		20-30 Vdc	CSSP752030DCCLP
Ceiling — Four Hubs 3/4" NPT, Three Close-Up Plugs, Rigid Conduit			
		20-30 Vdc	CSSC752030DCCLP
Fixture Unit Only — Less Mounting Hood			
		20-30 Vdc	CSSB752030DCCLP
Fixture Unit Only — Less Mounting Hood			
	4.7 kg (10.36 lb)	20-30 Vdc	CSST2030PDCCL
	Weight kg (lb)	Hub Size (Inches)	Catalog Number — UL1971: Hearing-Impaired
Pendant Mounting Hood — One Hub 3/4" NPT, Rigid Conduit			
	9.0 (19.84)	3/4	CAP-751971
Ceiling Mounting Hood — Four Hubs 3/4" NPT, Three Close-Up Plugs, Rigid Conduit			
	1.8 (3.97)	3/4	CAC-751971
Bracket Mounting Hood — Four Hubs 3/4" NPT, Three Close-Up Plugs, Rigid Conduit			
	2.7 (5.95)	3/4	CALB-751971



① Only clear globes are available for UL1971 applications.

Code•Master™ Factory Sealed Strobe Luminaires

Explosionproof, Dust-Ignitionproof

NEC:
 Class I, Division 1 and 2, Groups C, D
 Class I, Division 2, Groups A, B
 Class II, Division 1 and 2, Groups E, F, G
 Class III
 NEMA 3R, 4X

NEC:
 Suitable for Wet Locations
 Marine Outside Type (Saltwater)

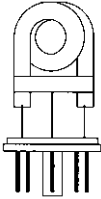
Description		Weight kg (lb)	Catalog Number	
Optional Aluminum Guard				
		0.5 (1.10)	CJGU-15	
Replacement Connection Block — Standard				
	For Non-Hearing-Impaired CodeMaster Fixtures	0.2 (0.44)	VPT-7	
Replacement Connection Block — UL1971: Hearing-Impaired				
	For Code-Master Fixtures for the Hearing Impaired	0.2 (0.44)	VPT-7P	
Replacement Lamps				
Fixture Type	Lamp Type	Voltage	Base Type	Catalog Number
 Strobe	Xenon	All	Octal Socket	S865

Appleton

VISUAL SIGNAL: NEC/CEC EXPLOSIONPROOF

Code•Master™ Factory Sealed Strobe Luminaires

Explosionproof, Dust-Ignitionproof

NEC:
 Class I, Division 1 and 2, Groups C, D
 Class I, Division 2, Groups A, B
 Class II, Division 1 and 2, Groups E, F, G
 Class III
 NEMA 3R, 4X

NEC:
 Suitable for Wet Locations
 Marine Outside Type (Saltwater)

Pendant
 One Hub, 3/4" NPT
CAP75 or CAP75-1971



Ceiling
 Four Hubs, Three Close-Up Plugs, 3/4" NPT
CAC75 or CAC75-1971



Bracket
 Four Hubs, Three Close-Up Plugs, 3/4" NPT
CALB75 or CALB75-1971



**Code•Master Incandescent Fixture Unit
 CSST**



**Optional Aluminum Guard
 CJGU-15**

Dimensions in Millimeters (Inches)

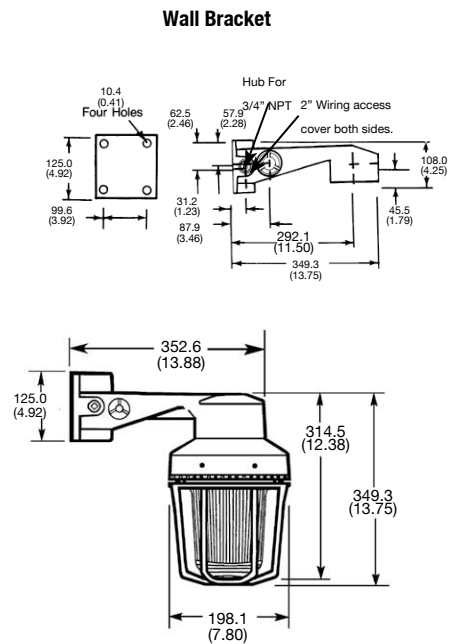
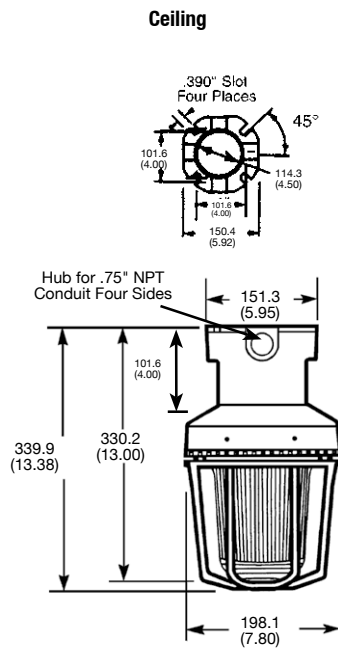
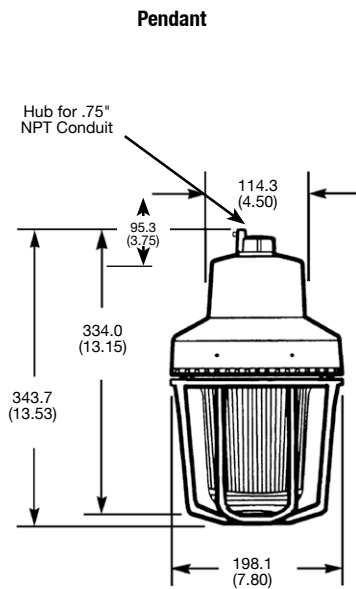

① UL1971: Hearing-Impaired Strobe Only
 ② Diode polarized (current limiter supplied as standard).

ATX™ SBDO Series Signaling and Lighting Bulkheads

Flameproof. Compact Fluorescent, Incandescent

ATEX/IECEX:
Zone 1 and 2 - 21 and 22
Ⓢ II 2 GD
IP66 - IK08

Applications

- For lighting and signaling.

Features

- For 7, 11, 15 Watt compact fluorescent or up to 100 Watt (maximum) incandescent (lamps not supplied).
- E27 lampholder.
- Operating in any position.
- Fixing by 2 integrated brackets.
- Connection to lampholder via two terminals 1 x 2.5 mm² (0.002 x 0.004 in²).
- Internal earth two terminals 2.5 mm² (0.004 in²), external earth 1 x 4 mm² (0.002 x 0.006 in²).
- Two M20 entries through feed.
- Supplied with 1 blanking plug M20.

Standard Materials

- Body and bezel: gray painted aluminum
- Sealed toughened lamp glass
- Guard: zinc plated steel

ATEX/IECEX Certifications and Compliances

- Certification Type: HBOd
 - Zone 1 - 2
 - Conforming to ATEX 94/9/CE: Ⓢ II 2 G
 - Type of Protection: Ex d IIB
 - Temperature Class: Incandescent: T4, Compact Fluorescent: T6
 - Zone 21 - 22
 - Conforming to ATEX 94/9/CE: Ⓢ II 2 D
 - Type of Protection: Ex tD A21
 - Surface Temperature: Incandescent: T119 °C (T246 °F), Compact Fluorescent: T76 °C (T169 °F)
- Ambient Temperature: -20 °C to +40 °C (-4 °F to +104 °F)
- CE Declaration of Conformity: 50234
- ATEX Certificate: LCIE 02 ATEX 6162
- IECEx Certificate: LCIE Ex 0.3013
- Index of Protection according EN/IEC 60529: IP66
- Impact Resistance (shock): IK08
- Internal Volume: ≤ 2 dm³ (122 in³) – 2 liters

EURASEC Certification

- EURASEC N° TC RU C-FR.Г505.B.00912

Other Certification

- INMETRO Certificate: BVC11.0597 ①



Compact Fluorescent
Painted Glass Version

VISUAL SIGNAL: ATEX/IECEX FLAMEPROOF

Appleton

① Inmetro certification available on special request only. Contact your local sales representative for more information.

ATX™ SBDO Series Signaling and Lighting Bulkheads

Flameproof. Compact Fluorescent, Incandescent

ATEX/IECEX:
 Zone 1 and 2 - 21 and 22
 II 2 GD
 IP66 - IK08

Color (Painted Glass)	Weight kg (lb)	Volume dm ³ (in ³)	Catalog Number
7 W to 15 W Compact Fluorescent or up to 60 W Incandescent			
Red	3 (6.61)	9 (549.21)	SBDOSR
Green	3 (6.61)	9 (549.21)	SBDOSG

Accessories and Replacement Parts

Description	Catalog Number
Zinc Plated Steel Protective Guard	HBDOPGZ
Terminal block for through wiring 2 x 2.5 mm ² (0.003 x 0.004 in ²) with high temperature sleeve	094784

Dimensions in Millimeters (Inches)

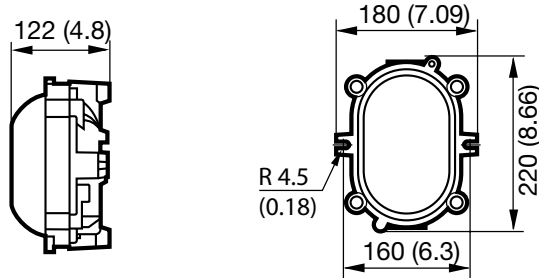

VISUAL SIGNAL: ATEX/IECEX FLAMEPROOF

Appleton®

ATX™ SBDS Series Beacon Lighting Units

Flameproof

ATEX:
Zone 1 and 2 - 21 and 22
Ⓢ II 2 GD
IP66 - IK08

Applications

- For use in hazardous locations in a wide range of plants.
- In areas where audible signals cannot be heard.

Features

- Fixtures operate in any position.
- Suspension via integral bolt.
- Threaded flame path.
- Internal earth terminal 2 x 4 mm² (0.003 x 0.006 in²).
- External earth terminal 1 x 4 mm² (0.002 x 0.006 in²).
- Two M20 threaded entries with one blanking plug.
- Globe available in four colors: red, amber, green and clear (to be ordered separately).
- Static Beacon:
 - E27 lamp holder.
 - Permissible lamps not supplied:
 - 100 W incandescent max.
 - 18/20/25 W compact fluorescent
 - Connection to lamp holder via two terminals 1 x 2.5 mm² (0.002 x 0.003 in²) or 2 x 4 mm² (0.003 x 0.006 in²) terminal block supplied.
- Rotating Beacon:
 - E14 lamp holder.
 - 40 W incandescent lamp supplied.
 - Rotating speed: approximately 170 rotations per minute.
 - Beaten mirror to reinforce bright effect.
 - Connection via two terminals 2 x 4 mm² (0.003 x 0.006 in²).

Standard Materials

- Body and bezel: gray painted marine aluminum
- Glass: colorless sealed shock resistant
- Reflector for static beacon: internal aluminum
- Globe: colored polymethacrylate
- Protective guard: zinc plated steel
- Mounting bracket: zinc plated steel

ATEX Certifications and Compliances

- Certification Type: AB14
 - Gas: Zones 1 and 2
 - Conforming to ATEX 94/9/CE: Ⓢ II 2 G
 - Type of Protection: Ex d IIB
 - Temperature Class: See *T Rating (Gas) and Surface Temperature (Dust) Table*

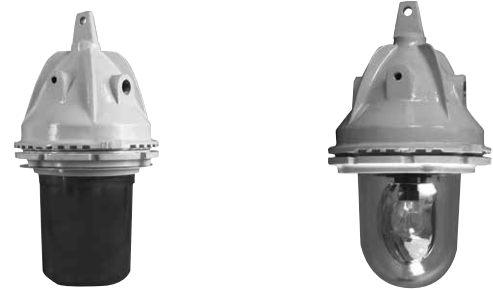

Static Beacon with Red Globe

Rotating Beacon

- Dust: Zone 21 and 22
- Conforming to ATEX 94/9/CE: Ⓢ II 2 D
- Type of Protection: Ex tD A21
- Surface Temperature: See *T Rating (Gas) and Surface Temperature (Dust) Table*
- Ambient Temperature:
 - Static: -40 °C to +50 °C (-40 °F to +122 °F)
 - Rotating: -20 °C to +50 °C (-4 °F to +122 °F)
- CE Declaration of Conformity: 50231
- ATEX Certificate: LCIE 02 ATEX 6053
- Index of Protection (solid and liquid): IP66
- Impact Resistance (shock): IK08
- Internal Volume: ≤ 2 dm³ (122 in³) - 2 liters

Other Certification

- INMETRO Certificate: BVC11.0480 ①

T Rating (Gas) and Surface Temperature (Dust) Table

Lamp Type and Wattage	Ambient Temperature — T Rating for Gas				Ambient Temperature — Surface Temperature for Dust		
	T Rating	Ta = +40 °C (+104 °F)		Ta = +50 °C (+122 °F)		Surface Temperature	Cable Entry Temperature
		T Rating	Cable Entry Temperature	T Rating	Cable Entry Temperature		
18 W Compact Fluorescent	T6	–	–	T5	–	+85 °C (+185 °F)	–
20 W Compact Fluorescent	T6	–	–	T5	–	+85 °C (+185 °F)	–
25 W Compact Fluorescent	T6	–	–	T5	–	+85 °C (+185 °F)	–
100 W Incandescent	T4	+115 °C (+239 °F)	–	T3	+125 °C (+257 °F)	+145 °C (+293 °F)	+125 °C (+257 °F)
40 W Rotating	T5	–	–	T4	–	+110 °C (+230 °F)	–



① Inmetro certification available on special request only. Contact your local sales representative for more information.

ATX™ SBDS Series Beacon Lighting Units



Flameproof

ATEX:
Zone 1 and 2 - 21 and 22
II 2 GD
IP66 - IK08

VISUAL SIGNAL: ATEX/IECx FLAMEPROOF

Lamp Type and Wattage	Supply	Frequency (Hz)	Rating (Amps)	Weight (kg (lb))	Volume (dm ³ (in ³))	Catalog Number
Clear Static Beacon						
 100 W maximum	—	—	—	7.5 (16.53)	30 (1830.7)	SBDSSC
Clear Rotating Beacon						
 40 W Incandescent	48 V ±10%	50/60 Hz	1 A	8.5 (18.74)	30 (1830.7)	SBDSRC4004A
40 W Incandescent	48 Vdc ±10%	—	1 A	8.5 (18.74)	30 (1830.7)	SBDSRC4004D
40 W Incandescent	110 V ±10%	50/60 Hz	0.5 A	8.5 (18.74)	30 (1830.7)	SBDSRC4011A
40 W Incandescent	230/240 V ±10%	50/60 Hz	0.23 A	8.5 (18.74)	30 (1830.7)	SBDSRC4024A

Accessories and Replacement Parts

Type	Catalog Number
Polymethacrylate Globe	
 Red	SBDGR
Green	SBDGG
Amber	SBDGA
Clear	SBDGC
Zinc Plated Steel Protective Guard	
 Not to be used if a colored globe is used	LDPG3Z
Zinc Plated Steel Hinged Bracket	
 For installation on flat surface	LDPHBZ

Dimensions in Millimeters (Inches)

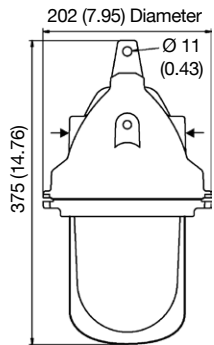

Lighting Unit

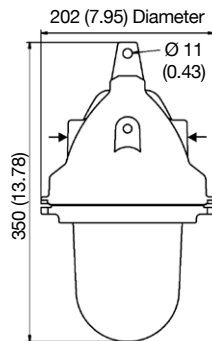

Lighting Unit with Globe

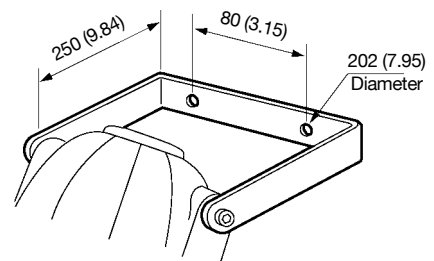

LDPHBZ Mounting Bracket

ATX™ SBDB Series Beacon and Strobe Lighting Units

Flameproof

ATEX/IECEX:
Zone 1 and 2 - 21 and 22
Ⓢ II 2 GD
IP66/67 - IK8

Applications

- For use in hazardous locations in a wide range of plants.
- In areas where audible signals cannot be heard.
- To warn of unsafe conditions and other communication needs.

Features

- Fixtures operate in any position.
- Mounting strap for surface mounting supplied.
- High temperature internal wiring.
- Threaded flame path.
- Stainless steel fastenings.
- Closed by screwing on bezel.
- Connection through an increased safety Exe compartment with terminal block
 - Two 2 x 6 mm² (0.003 x 0.009 in²) and two earth terminal 1 x 4 mm² (0.002 x 0.006 in²).
- External earth terminal 1 x 4 mm² (0.002 x 0.006 in²).
- Two side M20 threaded entries supplied with:
 - 1 x M20 plastic cable-gland for unarmored cable — 6.5 to 14.5 mm (0.26 x 0.57 in) sealing diameter.
 - 1 x M20 blanking plug.
- Static Beacon:
 - E27 lamp holder.
 - Permissible lamps not supplied:
 - 100 W incandescent max.
 - 18 W compact fluorescent.
 - Globe available in four colors:
 - Red, amber, green and clear (to be ordered separately).
- Rotating Beacon:
 - E14 lamp holder.
 - 40 W incandescent lamp supplied.
 - Rotating speed: approximately 170 rotations per minute.
 - Beaten mirror to reinforce bright effect.
 - Globe available in four colors:
 - Red, amber, green and clear (to be ordered separately).
- 5 Joules Strobe Beacon:
 - Xenon lamp supplied.
 - Instantaneous illuminance: 50,000 candles.
 - Strobe 60 flashes per minute.
 - Operating factor 100%.
 - Life duration: 70% efficiency after 8 million flashes.
 - Internal red colored lens supplied as standard.
 - Other lenses available in five colors:
 - Amber, blue, green, yellow and clear (factory installed).

Standard Material of Fixtures

- Body and bezel: gray painted marine aluminum
- Lens: colorless sealed shock resistant glass
- Internal reflector for static beacon: aluminum
- Mounting strap: gray painted aluminum

Standard Material of Accessories

- Globe: colored Polymethacrylate
- Protective guard: zinc plated steel

Options

- Other lens colors for strobe beacon



Strobe Lighting

Beacon Lighting

ATEX/IECEX Certifications and Compliances

- Certification Type: LTd (model (LT1d)
 - Gas: Zones 1 and 2
 - Conforming to ATEX 94/9/CE: Ⓢ II 2 G
 - Type of Protection: Ex de IIC
 - Temperature Class: See *Temperature Rating* — Gas table on following page
 - Dust: Zone 21-22
 - Conforming to ATEX 94/9/CE: Ⓢ II 2 D
 - Type of Protection: Ex tD A21
 - Surface Temperature: See *Temperature Rating* — Dust table on following page
- Ambient Temperature:
 - Strobe: -40 °C to +55 °C (-40 °F to +131 °F)
 - Rotating Beacon: -20 °C to +50 °C (-4 °F to +122 °F)
- CE Declaration of Conformity: 50246
- ATEX Certificate: LCIE 02 ATEX 6165
- IECEx Certificate: IECEx LCI Ex 04.0019
- Index of Protection according EN/IEC 60529: IP66/67
- Impact Resistance (shock): IK08

Other Certification

- INMETRO Certificate: BVC11.0417 ①

① Inmetro certification available on special request only. Contact your local sales representative for more information.

ATX™ SBDB Series Beacon and Strobe Lighting Units

Flameproof

ATEX/IECEX:
 Zone 1 and 2 - 21 and 22
 II 2 GD
 IP66/67 - IK8

Order using catalog numbering guide below or select catalog number from the following pages.

Catalog Numbering Guide – SBDB Series Beacon and Strobe Lighting Units

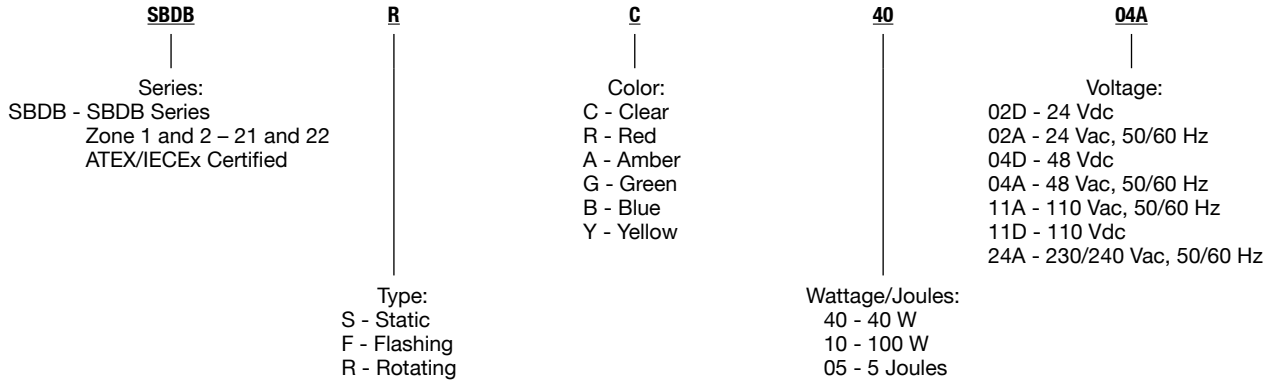

VISUAL SIGNAL: ATEX/IECEX FLAMEPROOF

Appleton®

Temperature Rating – Gas

Lamp Type and Wattage	Ambient Temperature					
	Lighting Downwards			Lighting Upwards		
Ta =	+40 °C (+104 °F)	+50 °C (+122 °F)	+55 °C (+131 °F)	+40 °C (+104 °F)	+50 °C (+122 °F)	+55 °C (+131 °F)
18 W Fluorescent Compact	T6	T6	T6	T6	T5	T5
100 W Incandescent	T4	T3	T3	T3	T3	T3
40 W Rotating	T5	T4	T4	T5	T4	T4
Strobe 5 Joules	T6	T6	T6	T6	T6	T6

Temperature Rating – Dust

Lamp Type and Wattage	Positions	
	Lighting Downwards	Lighting Upwards
Ta =	+55 °C (+131 °F)	+55 °C (+131 °F)
18 W Fluorescent Compact	T80 °C (T176 °F)	T95 °C (T203 °F)
100 W Incandescent	T195 °C (T383 °F)	T195 °C (T383 °F)
40 W Rotating	T130 °C (T266 °F)	T130 °C (T266 °F)
Strobe 5 Joules	T80 °C (T176 °F)	T80 °C (T176 °F)





ATX™ SBDB Series Beacon and Strobe Lighting Units

Flameproof

ATEX/IECEX:
Zone 1 and 2 - 21 and 22
II 2 GD
IP66/67 – IK8

Type	Supply	Rating (Amps)	Weight (kg (lb))	Volume (dm ³ (in ³))	Catalog Number
Clear Static Beacon					
100 W Maximum	—	—	7.5 (16.3)	30 (1830.7)	SBDBSC
Clear Rotating Beacon					
40 W	48 Vac	+/-10%	50/60 Hz	1A	8.5 (18.74) 30 (1830.7) SBDBRC4004A
40 W	48 Vdc	+/-10%	—	1A	8.5 (18.74) 30 (1830.7) SBDBRC4004D
40 W	110 Vac	+/-10%	50/60 Hz	0.5A	8.5 (18.74) 30 (1830.7) SBDBRC4011A
40 W	230/240 Vac	+/-10%	50/60 Hz	0.23A	8.5 (18.74) 30 (1830.7) SBDBRC4024A
Red Strobe Beacon					
5 joules	24 Vac	20-30 V	50/60 Hz	220 mA	8.5 (18.74) 30 (1830.7) SBDBFR0502A
5 joules	24 Vdc	18-35 V	—	230 mA	8.5 (18.74) 30 (1830.7) SBDBFR0502D
5 joules	48 Vac	40-54 V	50/60 Hz	180 mA	8.5 (18.74) 30 (1830.7) SBDBFR0504A
5 joules	48 Vdc	40-60 V	—	150 mA	8.5 (18.74) 30 (1830.7) SBDBFR0504D
5 joules	110 Vac	90-135 V	50/60 Hz	110 mA	8.5 (18.74) 30 (1830.7) SBDBFR0511A
5 joules	110 Vdc	88-132 V	—	90 mA	8.5 (18.74) 30 (1830.7) SBDBFR0511D
5 joules	230/240 Vac	185-255 V	50/60 Hz	55 mA	8.5 (18.74) 30 (1830.7) SBDBFR0523A

Accessories and Replacement Parts

Description	Catalog Number
Polymethacrylate Globe	
	Red SBDGR
	Green SBDGG
	Amber SBDGA
	Clear SBDGC
Zinc Plated Steel Protective Guard	
	Using without colored globe LDPG1Z
Zinc Plated Steel Hinged Bracket	
	Bracket for installation on flat surface LDMHBZ
Zinc Plated Steel M10 Eyebolt	
	Eyebolt for suspension LDRBM10Z

VISUAL SIGNAL: ATEX/IECEX FLAMEPROOF

Appleton®

ATX™ SBDB Series Beacon and Strobe Lighting Units

Flameproof

ATEX/IECEX:
Zone 1 and 2 - 21 and 22
II 2 GD
IP66/67 - IK8

Dimensions in Millimeters (Inches)

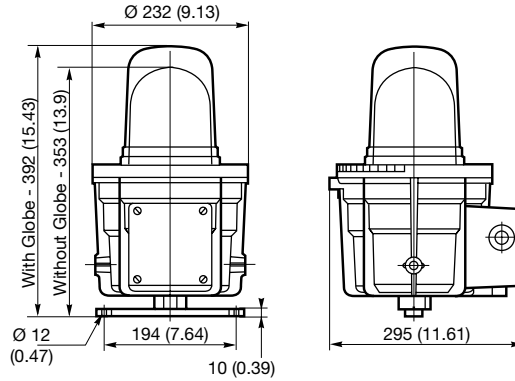

VISUAL SIGNAL: ATEX/IECEX FLAMEPROOF

Appleton®

ATX™ SBDC Series Strobe Lighting and Static Triple Indicator

Flameproof

ATEX/IECEX:
 Zone 1 and 2 - 21 and 22
 Ⓢ II 2 GD
 IP66/68 - IK08

Applications

- For use in hazardous locations in a wide range of plants.
- In areas where audible signals cannot be heard.
- To warn of unsafe conditions and other communication needs.

Features

- Threaded access cover with O-ring seal.
- Supplied with two external fixing lugs.
- Fixtures operate in any position.
- External earth terminal 1 x 4 mm² (0.002 x 0.006 in²).
- Two side M20 threaded entries supplied with 1 x M20 blanking plug.
- 15 Joules Strobe Beacon:
 - Xenon lamp supplied.
 - Instantaneous illuminance: 150,000 candelas.
 - Strobe 45 flashes per minute.
 - Operating factor: 10 min. stop after one hour operation.
 - Life duration: 70% efficiency after 8 million flashes.
 - Internal red colored lens supplied as standard.
 - Other lenses available in five colors:
 - Amber, blue, green, yellow and clear (factory installed).
 - Connection to plug-in terminal block via 2 x 3 x 2.5 mm² (0.003 x 0.005 x 0.004 in²) terminal.
- Static Triple Indicator Unit:
 - Ba15d lamp holders.
 - Permissible lamps not supplied:
 - 7 W incandescent or multi LED lamps.
 - Operating factor 100%.
 - Supplied with three colored interchangeable modules:
 - Red, yellow and green.
 - Each module is controlled separately.
 - Possibility of coupling two modules for simultaneous operation.
 - Connection to plug-in terminal block via 2 x 5 x 2.5 mm² (0.003 x 0.008 x 0.004 in²) terminal.

Standard Materials

- End caps and cover: anti-corrosive gray painted Zamak
- O-ring seal: Nitrile
- Sealed toughened glass.
- Fixing lug: zinc plated steel
- Protective guard: zinc plated steel

Options

- Other colored module for static triple indicator unit.
- Other lens colors available for strobe lighting



Strobe Lighting



Multiple Static Indicator

ATEX/IECEX Certifications and Compliances

- Certification Type: FLd
 - Gas: Zones 1 and 2
 - Conforming to ATEX 94/9/CE: Ⓢ II 2 G
 - Type of Protection: Ex d IIC
 - Temperature Class: See *T Rating (Gas) and Surface Temperature (Dust) Table*
 - Dust: Zone 21 and 22
 - Conforming to ATEX 94/9/CE: Ⓢ II 2 D
 - Type of Protection: Ex tD A21
 - Surface Temperature: See *T Rating (Gas) and Surface Temperature (Dust) Table*
- Ambient Temperature: -40 °C to +55 °C (-40 °F to +131 °F)
- CE Declaration of Conformity: 50203
- ATEX Certificate: LCIE 97 ATEX 6012
- IECEx Certificate: IECEx LCI 04.0018
- Index of Protection according EN/IEC 60529: IP66/68 (10 meters)
- Impact Resistance (shock): IK08
- Internal Volume: ≤ 2 dm³ (122 in³) - 2 liters

EURASEC Certification

- EURASEC N° TC RU C-FR.Г505.B.00912

Other Certification

- INMETRO Certificate: BVC11.0492 ①

Related Products

- For labels see *Labels for Emergency Lighting Units, ATX Self-Adhesive Signaling Labels for Emergency Lighting Units.*

T Rating (Gas) and Surface Temperature (Dust) Table

Ambient Temperature	Gas		Dust
	Ta = +40 °C (+104 °F)	Ta = +55 °C (+131 °F)	Ta = +55 °C (+131 °F)
Strobe 15 Joules	T6	T5	T95 °C (T203 °F)
Static Indicator	T6	T6	T80 °C (T176 °F)

① Inmetro certification available on special request only. Contact your local sales representative for more information.

ATX™ SBDC Series Strobe Lighting and Static Triple Indicator

Flameproof

ATEX/IECEX:
 Zone 1 and 2 - 21 and 22
 II 2 GD
 IP66/68 - IK08

Catalog Numbering Guide

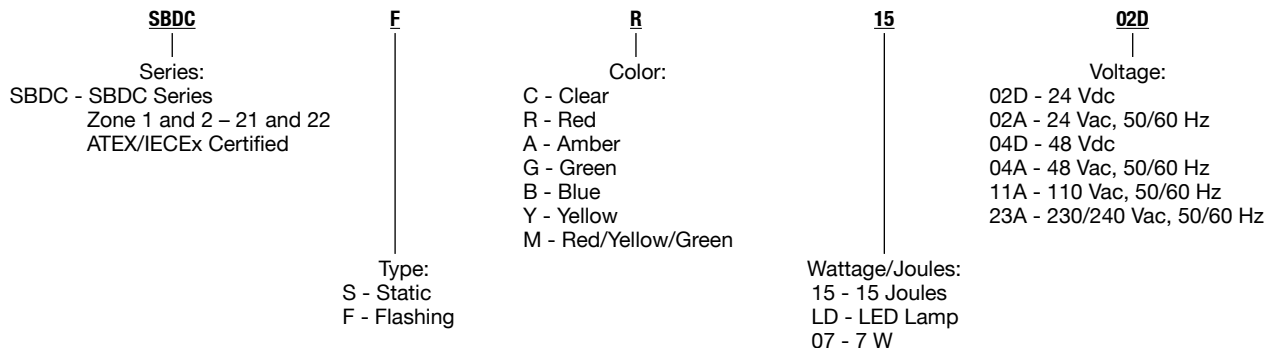

VISUAL SIGNAL: ATEX/IECEX FLAMEPROOF

Appleton®

Red Strobe Beacon

Type	Supply	Rating (Amps)	Weight kg (lb)	Volume dm ³ (in ³)	Catalog Number ①②		
 15 joules	24 Vdc	18-30 V	—	700 mA	6.8 (14.99)	31 (1891.7)	SBDCFR1502D
15 joules	48 Vdc	40-60 V	—	350 mA	6.8 (14.99)	31 (1891.7)	SBDCFR1504D
15 joules	110 Vac	95-127 V	50/60 Hz	350 mA	6.8 (14.99)	31 (1891.7)	SBDCFR1511A
15 joules	230 Vac	185-255 V	50/60 Hz	190 mA	6.8 (14.99)	31 (1891.7)	SBDCFR1523A

Triple Static Indicator





Type	Lamp Holder	Wattage	Weight kg (lb)	Volume dm ³ (in ³)	Catalog Number ②
 Red, yellow and green 230 Vac, 50/60 Hz	Ba15d	7 W	6.8 (14.99)	31 (1891.7)	SBDCSM0723A

① For lens color other than Red on the IECEx certified product change the replace the letter **R** in the 5th position to the appropriate option: **C** for Clear, **A** for Amber, **G** for Green, **B** for Blue or **Y** for Yellow. Example for clear lens: SBDCFC1502D.
 ② For LED lamp on the IECEx certified product change the replace the letters **15** or **07** with the letters **LD** in the 7th and 8th positions. Example: SBDCFRLD02D.

ATX™ SBDC Series Strobe Lighting and Static Triple Indicator Flameproof

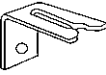
ATEX/IECEX:
Zone 1 and 2 - 21 and 22
II 2 GD
IP66/68 - IK08

Accessories and Replacement Parts

Type	Weight kg (lb)	Volume dm ³ (in ³)	Catalog Number
Mounting Brackets – Quick One Hand Fixings: Set of Two			
 Zinc plated steel	0.40 (0.88)	0.7 (42.7)	FDFBZ
Stainless steel			FDFBS
Surface Mounting Brackets: Set of Two			
 Zinc plated steel	0.55 (1.21)	0.5 (30.5)	FDSBZ
Stainless steel			FDSBS
Half Clamps – Set of Two – Zinc Plated Steel			
 42 mm (1.25") to 49 mm (1.5")	0.80 (1.76)	0.5 (30.5)	FDHC49Z
60 mm (2")			FDHC60Z
Protective Guard			
 Zinc plated steel	0.55 (1.21)	8.0 (488.2)	FDPG1Z

Dimensions in Millimeters (Inches)

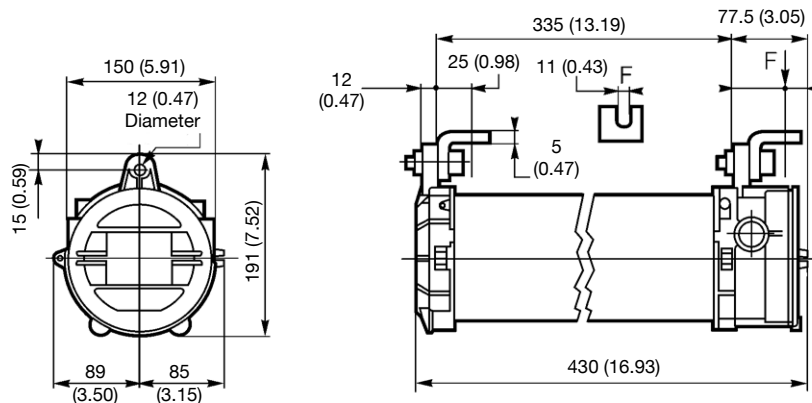

ATX™ Self-Adhesive Signaling Labels for Emergency Lighting Units

















For use on Appleton/ATX emergency lighting luminaires: FDBAES, FDES and FNES Series

Features

- Select styles available in French, English, Spanish, Portuguese and version which conform to Directive CEE 77-576.

Standard Materials

- Plastic coated
- White lettering.
- Green background.

	Length mm (in)	Width mm (in)	Units per Pack	Catalog Number
French				
	237 (9.33)	53 (2.09)	10	094904
	237 (9.33)	53 (2.09)	10	094905
	237 (9.33)	109 (4.29)	10	094906
	172 + 57 (6.77 + 2.24)	57 (2.24)	10	094907
	237 (9.33)	109 (4.29)	5	094908
	237 (9.33)	109 (4.29)	5	094909
	237 (9.33)	109 (4.29)	5	094910
English				
	230 (9.06)	45 (1.77)	5	094915
	230 (9.06)	90 (3.54)	5	094916
	230 (9.06)	45 (1.77)	5	094917
Spanish				
	237 (9.33)	109 (4.29)	5	094919
	175 + 57 (6.89 + 2.24)	57 (2.24)	5	094918
Portuguese				
	237 (9.33)	109 (4.29)	5	094913
	175 + 57 (6.89 + 2.24)	57 (2.24)	5	094914
Conforming to Directive CEE 77-576				
	237 (9.33)	109 (4.29)	5	094911
	237 (9.33)	109 (4.29)	5	094912

LABELS FOR ATEX/IECEx EMERGENCY LIGHTING UNITS

Appleton®

Stylmaster™ Incandescent Luminaires

Enclosed and Gasketed

Attractively styled fixture with prismatic globe. UNILETS® for use with threaded metal conduit.

NEC:
Class I, Division 2, Groups A, B, C, D

CEC:
Class I, Division 2, Groups A, B, C, D
Class II, Division 1 and 2, Groups E, F, G
Class III
Enclosure 4X

Applications

- Enclosed and gasketed lighting fixtures for use in storage areas, tunnels, subways, chemical plants and other areas where moisture, dirt or corrosive atmospheres are a problem.
- Suitable for use in wet locations.
- Standard fixtures designed for 60 to 300 Watt medium base incandescent lamps.
- Pendant, feed-thru, ceiling, stanchion and wall mounts available.
- Ventilated steel reflectors with white porcelain finish are available for standard applications. Fiberglass reinforced polyester reflectors are designed for installations where fixture is subject to severe corrosive conditions or vandalism.

Features

- Modern styling, with clean-line mounting hood and prismatic glass globe, plus optional guard.
- Prismatic globe, furnished as standard, eliminates glare and distributes light evenly.
- Globe seats firmly against composition gasket in mounting hood to keep out dirt and moisture. Full threads eliminate "cross threading."
- Fixture is complete with gaskets and socket. Socket is shock-absorbing to prolong lamp life and can be easily removed for wiring without tools.
- Porcelain socket construction assures long trouble-free operation in high ambient installations.
- Both porcelain steel and polyester reflectors are secured to mounting hoods with screws (furnished).
- Guards have exclusive snap-on attachment feature for quick installation and fast servicing.
- Choice of reflector styles:
 - (1) steel reflector with white porcelain enamel in standard dome and 30° angle
 - (2) fiberglass reinforced polyester reflector in standard dome and 30° angle.
- Maximum input voltage 277 V (suitable for DC applications).

Standard Materials

- Mounting hoods: copperfree (4/10 of 1% max.) aluminum
- Guards: pressure cast copperfree (4/10 of 1% max.) aluminum
- Reflectors: porcelain steel or fiberglass reinforced polyester
- Socket: porcelain with brass screw shell
- Globes: prismatic glass

Standard Finishes

- Mounting hoods and guards: epoxy powder coat
- Steel reflectors: baked white porcelain enamel
- Fiberglass reinforced polyester reflectors: natural finish
- Socket and globes: natural finish

Options

- To order fixture with other than standard clear glass globe, add suffix letters to catalog number as indicated in table, and adjust difference in price.

Color	Glass Globe	Plastic Globe
Amber	-AM	-PAM
Blue	-BL	-PBL
Green	-GR	-PGR
Red	-RE	-PRE
Clear Heat-Resistant	-HR	—



Illustrated Features



Mounting Hood

Pendant style shown has setscrew to prevent fixture stem from turning. Other styles include stanchion, ceiling and wall mounting.



Shock-Absorbing Medium Base Socket

Spring absorbs vibration to prolong lamp life. Porcelain construction for trouble-free operation in high ambient installations.



Globe

Attractive, tapered prismatic glass globes for glare elimination and uniform light distribution. Colors available – also vandal-resistant plastic globes. Globe seats firmly against gasket to exclude moisture, dirt and vapors.

Guard

Snap-on guards (and reflectors) – simply snap-in and twist. Spring action balls snap into detents of fixture body.

Guard and Reflectors

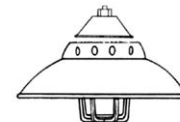
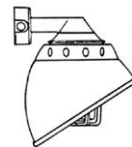
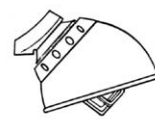
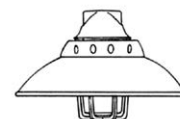
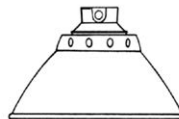

NEC/CEC Certifications and Compliances

- UL Standard: UL 1598, UL 844
- UL Listed: E10444
- CSA Standard: C22.2 No. 250, C22.2 No. 137
- CSA Certified: 025428

Stylmaster™ Incandescent Luminaires

Enclosed and Gasketed

Attractively styled fixture with prismatic globe. UNILETS® for use with threaded metal conduit.

NEC:
Class I, Division 2, Groups A, B, C, D

CEC:
Class I, Division 2, Groups A, B, C, D
Class II, Division 1 and 2, Groups E, F, G
Class III
Enclosure 4X

Class I, Division 2, Groups A, B, C, D

Fixture is suitable for Class I, Division 2 where the fixture operating temperature does not exceed the ignition temperature of the atmosphere in which fixture is installed.

"T" Numbers Represent the Maximum Lamp Temperature for Class I, Division 2 Locations

Supply Wire: +200 °C (+392 °F)

"T" Number	T1	350	325	T2	T2A	T2B	T2C	T2D	T3	T3A	T3B	T3C	T4	T4A	T5	T6
Temp. Range (°C)	351-450	326-350	301-325	281-300	261-280	231-260	216-230	201-215	181-200	166-180	161-165	136-160	121-135	101-120	86-100	85
Temp. Range (°F)	664-842	619-662	574-617	538-572	502-536	448-500	421-446	394-419	358-392	331-356	322-329	277-320	250-275	214-248	187-212	185

Class I, Division 2, Groups A, B, C, D

Reflector	VPGL-1HR (60-200 W)				VPGL-2HR (200-300 W)			
	A-21 100 W	A-21 150 W	A-23 200 W	A-23 200 W	PS-25 200 W	PS-30 200 W	PS-25 300 W	PS-30 300 W
None	T3	T2D	T2C	T2C	T2C	T2C	325	325
Standard Dome	T2D	T2D	T2B	T2B	T2B	T2C	325	325
30° Angle	T2D	T2C	T2B	T2B	T2B	T2B	325	325

Fixture Ambient Suitability:

Areas	°F	°C
Non-Classified	392	200
Classified	104	40

Fixture Ambient Suitability:

Class II, Groups E, F, G; Class III; Enclosure 4X

Fixture	Watts
A-23	60 to 300
PS-30	60 to 300









Stylmaster™ Incandescent Luminaires

Enclosed and Gasketed

Attractively styled fixture with prismatic globe. UNILETS® for use with threaded metal conduit.

NEC:
Class I, Division 2, Groups A, B, C, D

CEC:
Class I, Division 2, Groups A, B, C, D
Class II, Division 1 and 2, Groups E, F, G
Class III
Enclosure 4X

Without Guard	With Guard	Type	Lamp Watts	Hub Size (Inches)	NEC Catalog Numbers		CEC Catalog Numbers	
					With Globe and Guard	With Globe Only	With Globe and Guard	With Globe Only
Pendant – 3/4" tapped opening – Furnished with 3/4" to 1/2" reducer								
		A-23	60-200	1/2 or 3/4	VPA1075G	VPA1075	VCA1075G	VCA1075
		PS-30	200-300	1/2 or 3/4	VPA2075G	VPA2075	VCA2075G	VCA2075
Ceiling – Five Tapped Openings – With mounting lugs and four close-up plugs								
		A-23	60-200	1/2	VPX1050G	VPX1050	—	—
				3/4	VPX1075G	VPX1075	VCX1075G	VCX1075
		PS-30	200-300	1/2	VPX2050G	VPX2050	—	—
				3/4	VPX2075G	VPX2075	VCX2075G	VCX2075
Ceiling – Outlet Box Mounting – Fits SEH ① or VPJB cast outlet box, or 4" octagonal outlet box – Furnished with screws and gasket – Octagonal outlet boxes for non-classified areas only								
		A-23	60-200	3/4	VPOB10G	VPOB10	VCOB10G	VCOB10
		PS-30	200-300	3/4	VPOB20G	VPOB20	VCOB20G	VCOB20
45° Stanchion – 1-1/4" Conduit								
		A-23	60-200	1-1/4	VPAN10125G	VPAN10125	VCAN10125G	VCAN10125
		PS-30	200-300	1-1/4	VPAN20125G	VPAN20125	VCAN20125G	VCAN20125

① Order SEH box from catalog Fittings Section, 4" octagonal steel boxes from the Commercial Products Section and VPJB cast box from this Section.

Stylmaster™ Incandescent Luminaires

Enclosed and Gasketed









Attractively styled fixture with prismatic globe. UNILETS® for use with threaded metal conduit.

NEC:
Class I, Division 2, Groups A, B, C, D

CEC:
Class I, Division 2, Groups A, B, C, D
Class II, Division 1 and 2, Groups E, F, G
Class III
Enclosure 4X

Appleton

INCANDESCENT/AREA: NEC/CEC ENCLOSED AND GASKETED

Without Guard	With Guard	Type	Lamp Watts	Hub Size (Inches)	NEC Catalog Numbers		CEC Catalog Numbers	
					With Globe and Guard	With Globe Only	With Globe and Guard	With Globe Only
Wall – Body includes outlet box with five tapped openings – With mounting lugs and four close-up plugs								
		A-23	60-200	1/2	VPWB1050G	VPWB1050		
				3/4	VPWB1075G	VPWB1075	VCWB1075G	VCWB1075
		PS-30	200-300	1/2	VPWB2050G	VPWB2050		
				3/4	VPWB2075G	VPWB2075	VCWB2075G	VCWB2075
Wall – Outlet Box Mounting – Fits SEH ① or VPJB cast outlet box, or 4” octagonal outlet box – Furnished with screws and gasket – Octagonal outlet boxes for non-classified areas only								
		A-23	60-200		VPOBW10G	VPOBW10	VCOW10G	VCOW10
		PS-30	200-300		VPOBW20G	VPOBW20	VCOW20G	VCOW20
Wall – Outlet Box Mounting with Side Hubs – With two side hubs and one close-up plug								
		A-23	60-200	3/4	—	—	VCW1075G	VCW1075
		PS-30	200-300	3/4	—	—	VCW2075G	VCW2075

① Order SEH box from catalog Fittings Section, 4” octagonal steel boxes from the Commercial Products Section and VPJB cast box from this Section.









Stylmaster™ Incandescent Luminaires

Enclosed and Gasketed

Attractively styled fixture with prismatic globe. UNILETS® for use with threaded metal conduit.

NEC:
Class I, Division 2, Groups A, B, C, D

CEC:
Class I, Division 2, Groups A, B, C, D
Class II, Division 1 and 2, Groups E, F, G
Class III
Enclosure 4X

	Description	Hub Size (Inches)	Catalog Numbers	
			NEC	CEC
Pendant				
	Furnished with setscrew, 3/4" to 1/2" reducer for 1/2" stem, medium base socket.		VPA75	VCA75
Ceiling – Five Tapped Openings				
	Four close-up plugs	1/2	VPX50	VCX50
		3/4		VCX75
45° Stanchion				
		1-1/4	VPAN125	VCAN125
Wall – Five Tapped Openings in Outlet Box ①				
	Four close-up plugs	1/2	VPWB50	—
		3/4	VPWB75	—
Cast Outlet Box Only – Five Tapped Openings				
	Four close-up plugs. No socket. Fits VPOB, VPOBW and VPWB.	1/2	VPJB50	VCJB50
		3/4	VPJB75	VCJB75
Ceiling – For Outlet Box				
	(Octagonal outlet boxes for non-classified areas only) Fits SEH or VPJB cast outlet box, or 4" octagonal outlet box. With screws and gasket.		VPOB1	VCOB1
Wall – For Outlet Box ①				
	(Octagonal outlet boxes for non-classified areas only) Fits SEH or VPJB cast outlet box, or 4" octagonal outlet box. With screws and gasket.		VPOBW1	VCOBW1
Wall – Outlet Box Mounting with Side Hubs – With two side hubs and one close-up plug				
	(Octagonal outlet boxes for non-classified areas only)	3/4	—	VCB75

① Use 30° angle reflectors for wall installations – center line of fixture must be located at least 5-3/4" away from wall. Has four 3/16" dia. mounting holes located 90° apart on a 3-1/2" dia. center.

Stylmaster™ Incandescent Luminaires

Enclosed and Gasketed

Attractively styled fixture with prismatic globe. UNILETS® for use with threaded metal conduit.

NEC:
Class I, Division 2, Groups A, B, C, D

CEC:
Class I, Division 2, Groups A, B, C, D
Class II, Division 1 and 2, Groups E, F, G
Class III
Enclosure 4X

			Catalog Numbers				
			Type	Lamp Watts	Color	Glass	Polycarbonate
Glass and Polycarbonate Globes ①							
<p>Glass Globe (VPGL-1HR) Polycarbonate Globe (VPGL-2PL)</p>	A-23	60-200		Clear	—	VPGL-2PL	
				Clear Heat-Resistant	VPGL-1HR	—	
				Amber	VPGL-1AM	VPGL-2AMPL	
				Blue	VPGL-1BL	VPGL-2BLPL	
				Green	VPGL-1GR	VPGL-2GRPL	
				Red	VPGL-1RE	VPGL-2REPL	
Glass Globes							
<p>Glass Globe (VPGL-2HR)</p>	PS-30	200-300		Clear	—	—	
				Clear Heat-Resistant	VPGL-2HR	—	
				Amber	VPGL-2AM	—	
				Blue	VPGL-2BL	—	
				Green	VPGL-2GR	—	
				Red	VPGL-2RE	—	
Coated Tuff-Skin® ② Glass Globes Contains globe safely even if glass is broken							
<p>VPGL-2HRT</p>			Heat-Resistant		VPGL-2HRT	—	
			Type	Lamp Watts	Catalog Numbers		
					NEC	CSA	
Guards							
<p>VPGU-1 VPGU-2</p>	A-23	60-200			VPGU-1	VCFGU-1	
	PS-30	200-300			VPGU-2	VCFGU-2	
Replacement Porcelain Shock-Absorbing Sockets							
<p>Medium Base</p>	A-23	60-200			VPLR-123	VCLR-1	
	PS-30	200-300					
Replacement Gasket for Globes							
<p>Globe Gasket</p>			Neoprene – for all Stylmaster globes		VPGL-GK	VCGL-GK	

① Shatter-resistant for use in food processing plants, canneries, dairies, breweries, bakeries or anywhere broken glass would prove a hazard. Ideally suited for areas where vandalism, high replacement and high maintenance costs are a problem. CAUTION: Use maximum 200 W lamp less reflector, 100 W max. with reflector or colored globe. Do not use in ambients exceeding 25 °C/77 °F. For burning in vertical base-up position only.

② Registered trademark of Thomas Manufacturing Corporation, Parkton, Md.



Stylmaster™ Incandescent Luminaires

Enclosed and Gasketed

Attractively styled fixture with prismatic globe. UNILETS® for use with threaded metal conduit.

NEC:
Class I, Division 2, Groups A, B, C, D

CEC:
Class I, Division 2, Groups A, B, C, D
Class II, Division 1 and 2, Groups E, F, G
Class III
Enclosure 4X

	Description	Catalog Number	
		Porcelain Steel	Polyester
	Standard Dome Reflector	LPR-25ST	LPRP-25ST
	30° Angle Reflector	LPR-25AN	LPRP-25AN

Weights

Typical Mounting Hoods							
Pendant	kg (lb)	Ceiling	kg (lb)	Wall	kg (lb)	Stanchion	kg (lb)
VPA75	0.9 (1.98)	VPX75	0.9 (1.98)	VPOBW10	1.4 (3.09)	VPAN-125	1.4 (3.09)
VCA75		VCX75		VCOBW10		VCAN-125	

Globes and Guards					Reflectors			
Type	Globe	kg (lb)	Guard	kg (lb)	Standard Dome	kg (lb)	30° Angle	kg (lb)
60-200 W	VPGL-1	0.9 (1.98)	VPGU-1	0.5 (1.10)	LPR-25ST	1.4 (3.09)	LPR-25AN	0.9 (1.98)
200-300 W	VPGL-2	1.4 (3.09)	VPGU-2	0.5 (1.10)	LPRP-25ST	0.9 (1.98)	LPRP-25AN	0.9 (1.98)

Stylmaster™ Incandescent Luminaires

Enclosed and Gasketed

Attractively styled fixture with prismatic globe. UNILETS® for use with threaded metal conduit.

NEC:
Class I, Division 2, Groups A, B, C, D

CEC:
Class I, Division 2, Groups A, B, C, D
Class II, Division 1 and 2, Groups E, F, G
Class III
Enclosure 4X

Dimensions in Millimeters (Inches)

Pendant Mount ①

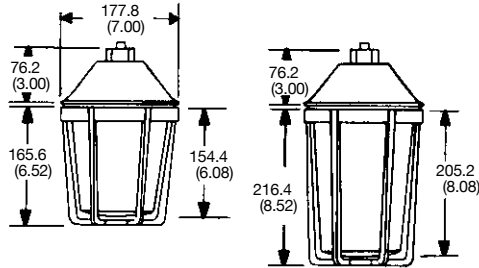

45° Stanchion Mount ① ②

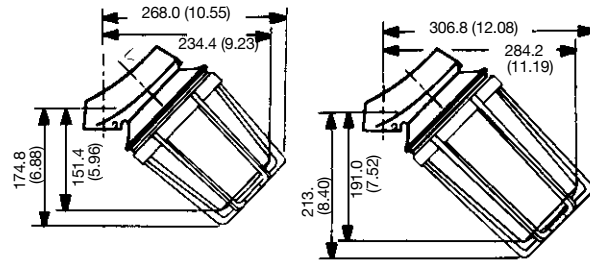

Ceiling Outlet Box Mount

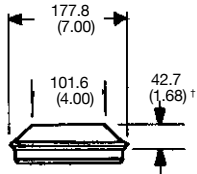

Ceiling Mount for Junction Box

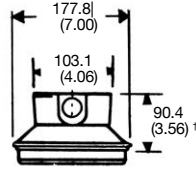

Wall Mount with Junction Box

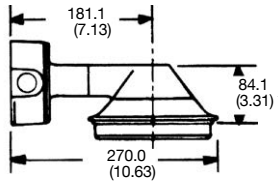

Wall Outlet Box Mount

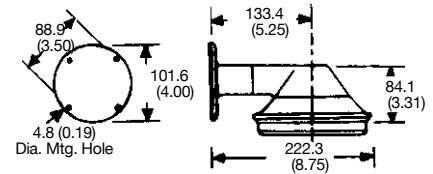

Junction Box Mounting Body

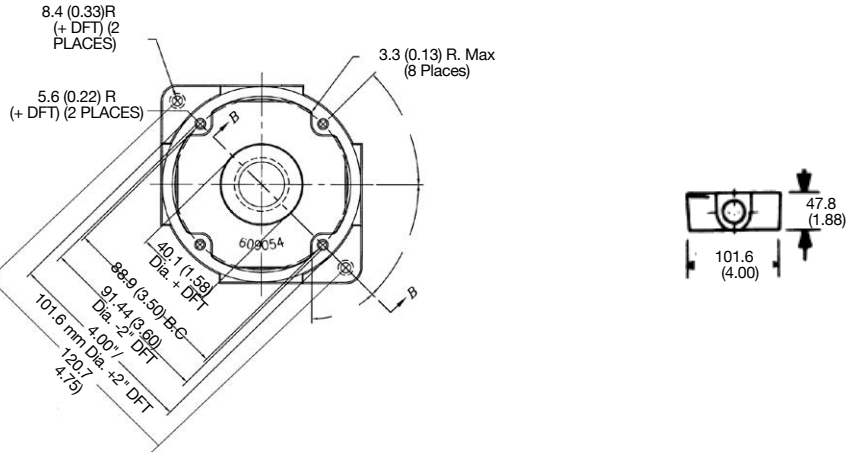

① Height of hood is measured to bottom of flange. Height of globe and guard is from bottom of flange.
② Dimensions of angle are from center of pipe. Height is measured from pipe stop in stanchion hood.

Stylmaster™ Incandescent Luminaires

Enclosed and Gasketed

Attractively styled fixture with prismatic globe. UNILETS® for use with threaded metal conduit.

NEC:
Class I, Division 2, Groups A, B, C, D

CEC:
Class I, Division 2, Groups A, B, C, D
Class II, Division 1 and 2, Groups E, F, G
Class III
Enclosure 4X

Photometric Data

Without Reflector

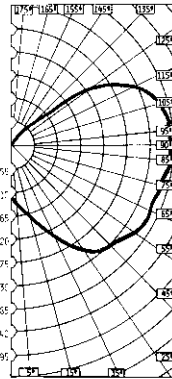

Effective Floor Cavity Reflectance (Rfc) is 20%

% Ceiling Rcc	% Walls Rw	Effective Floor Cavity Reflectance (Rfc) is 20%															
		80			70			50			30			10			0
		50	30	10	50	30	10	50	30	10	50	30	10	50	30	10	0
ROOM CAVITY RATIOS	1	.739	.689	.645	.684	.640	.598	.583	.548	.517	.489	.464	.439	.404	.384	.365	.322
	2	.618	.548	.489	.572	.509	.456	.484	.435	.391	.403	.365	.331	.329	.299	.273	.234
	3	.527	.449	.386	.487	.416	.360	.411	.355	.308	.340	.297	.259	.275	.240	.210	.176
	4	.460	.378	.316	.425	.351	.294	.358	.299	.253	.297	.250	.212	.239	.202	.172	.140
	5	.398	.319	.258	.370	.296	.240	.313	.252	.206	.258	.209	.172	.208	.169	.138	.110
	6	.353	.273	.216	.325	.253	.199	.274	.215	.170	.227	.178	.141	.183	.143	.112	.087
	7	.312	.234	.181	.288	.216	.167	.242	.183	.141	.199	.152	.116	.161	.122	.092	.069
	8	.279	.204	.152	.257	.189	.142	.217	.161	.120	.180	.133	.099	.144	.106	.077	.056
	9	.251	.179	.130	.232	.166	.121	.196	.141	.102	.162	.116	.083	.130	.092	.065	.045
	10	.226	.157	.112	.208	.146	.104	.177	.124	.087	.146	.102	.070	.118	.081	.054	.037

Standard Dome

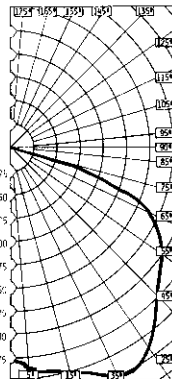
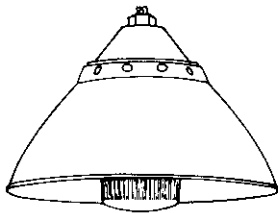

Effective Floor Cavity Reflectance (Rfc) is 20%

% Ceiling Rcc	% Walls Rw	Effective Floor Cavity Reflectance (Rfc) is 20%															
		80			70			50			30			10			0
		50	30	10	50	30	10	50	30	10	50	30	10	50	30	10	0
ROOM CAVITY RATIOS	1	.777	.747	.719	.759	.731	.706	.724	.701	.681	.693	.676	.658	.666	.650	.636	.620
	2	.679	.631	.589	.665	.620	.583	.636	.599	.566	.610	.580	.552	.587	.561	.537	.521
	3	.593	.534	.486	.581	.525	.481	.557	.510	.471	.535	.495	.461	.514	.480	.451	.435
	4	.523	.459	.409	.513	.453	.405	.492	.440	.398	.473	.428	.391	.456	.416	.384	.367
	5	.459	.391	.340	.449	.385	.337	.433	.376	.334	.416	.366	.328	.401	.358	.323	.307
	6	.406	.337	.289	.397	.333	.285	.382	.325	.282	.368	.317	.278	.356	.310	.274	.259
	7	.359	.291	.246	.352	.287	.242	.339	.279	.238	.326	.274	.235	.316	.269	.232	.217
	8	.323	.257	.211	.316	.254	.210	.305	.248	.208	.295	.243	.205	.284	.238	.203	.188
	9	.291	.227	.182	.286	.223	.182	.275	.219	.180	.266	.214	.178	.257	.210	.175	.161
	10	.262	.200	.159	.257	.199	.159	.249	.194	.157	.240	.190	.154	.234	.187	.152	.140

30° Angle

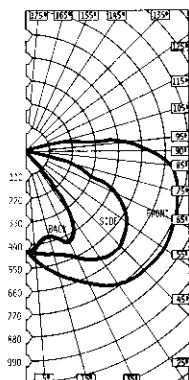
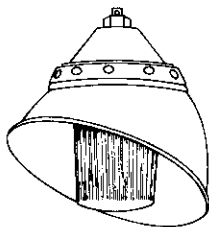

Photometric data shown on this page is based on a 200 Watt A-23 lamp and is representative of the performance for all Stylmaster incandescent fixtures. For candlepower values of fixtures with other lamps, multiply the given candlepower values by the following multipliers: for 75 W A19 – 0.31; for 100 W A19 – 0.45; for 150 W A21 – 0.75; and for 300 W PS25 – 1.65. For candlepower values of fixtures with guard, multiply by 0.90.

V-51™ Incandescent Luminaires

Enclosed and Gasketed

UNILETS® for use with threaded metal conduit. Fixtures suitable for use in wet locations. ①

NEC:
Class I, Division 2, Groups A, B, C, D

CEC:
Class I, Division 2, Groups A, B, C, D
Class II, Divisions 1 and 2, Groups E, F, G ②
Class III
Enclosure 3R

Applications

- Enclosed and gasketed lighting fixtures for use in storage areas, tunnels, subways, chemical plants and other areas where moisture, dirt or corrosive atmospheres are a problem.
- Suitable for use in wet locations.
- Standard fixtures designed for 60 to 300 W medium base incandescent lamps.
- Available in pendant, 45° stanchion, and a variety of ceiling and wall mountings.

Features

- Furnished with connection block for easy wiring.
- Unitized construction reduces installation and maintenance costs.
- Shock-absorbing porcelain socket for longer lamp life.
- Neoprene rubber ring in neck of reflector snaps into groove of mounting hood – protects against vibration and chipping.
- Guard snaps into two recesses of adapter – no clamps or setscrews.
- Maximum input voltage 150 V.

Standard Materials

- Mounting hoods: malleable iron
- Globe adapters: malleable iron
- Socket: porcelain with brass screw shell
- Globes: glass. Optional globes in polycarbonate plastic 100 W Max
- Guards: steel
- Reflectors: porcelain enamel steel

Standard Finishes

- Malleable iron mounting hood and globe adapter: triple coat – (1) zinc electroplate, (2) chromate, and (3) epoxy powder coat
- Steel guard: zinc electroplate
- Steel reflectors: white porcelain enamel
- Socket and globes: natural finish

Options

- To order fixture with other than standard clear glass globe, add suffix letters to catalog number as indicated in table, and adjust difference in price.

Color	Glass Globe	Plastic Globe
Amber	-AM	-PAM
Blue	-BL	-PBL
Green	-GR	-PGR
Red	-RE	-PRE
Clear Heat-Resistant	-HR	—

NEC/CEC Certifications and Compliances

- UL Standard: UL 1598, UL 844
- UL Listed: E10444
- CSA Standard: C22.2 No. 250, C22.2 No. 137
- CSA Certified: 025428



Illustrated Features

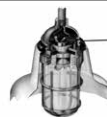

Cut-Away View

Connection block is easily removed (loosen two screws) to permit quick wiring.



Mounting Hood

Available in pendant (shown), ceiling, wall and 45° stanchion. Pendant has setscrew to prevent fixture from turning on stem.

Neoprene Ring

Neoprene attachment ring secures reflector to mounting hood – no tools needed.

Globe Adapter

When adapter is threaded onto mounting hood, the socket makes electrical contact with connection block in mounting hood. Available in malleable iron (VAD-1M and VAD-2M)

Porcelain Enamel Reflectors

Standard and 30° angle.



Guard

Two sealed ball plunger units snap quickly, easily and securely into cavities of globe adapter. Guard can be used with or without a reflector.

Guard and Reflectors

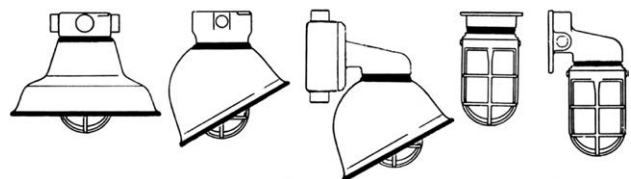

① With heat-resistant glass globes or plastic globes.

② 300 W PS-25 NOT approved for Class II, Division 1 and 2, Group G; Class III.

V-51™ Incandescent Luminaires

Enclosed and Gasketed

UNILETS® for use with threaded metal conduit. Fixtures suitable for use in wet locations. ①

NEC:
Class I, Division 2, Groups A, B, C, D

CEC:
Class I, Division 2, Groups A, B, C, D
Class II, Divisions 1 and 2, Groups E, F, G ②
Class III
Enclosure 3R

Class I, Division 2, Groups A, B, C, D

Fixture is suitable for Class I, Division 2 where the fixture operating temperature does not exceed the ignition temperature of the atmosphere in which fixture is installed.

“T” Numbers Represent the Maximum Lamp Temperature for Class I, Division 2 Locations

Supply Wire: 257 °F/125 °C

“T” Number	T1	350	325	T2	T2A	T2B	T2C	T2D	T3	T3A	T3B	T3C	T4	T4A	T5	T6
Temp. Range (°C)	351-450	326-350	301-325	281-300	261-280	231-260	216-230	201-215	181-200	166-180	161-165	136-160	121-135	101-120	86-100	85
Temp. Range (°F)	664-842	619-662	574-617	538-572	502-536	448-500	421-446	394-419	358-392	331-356	322-329	277-320	250-275	214-248	187-212	185

Class I, Division 2, Groups A, B, C, D

Reflector	60–150 W		200–300 W	
	A-21 100 W	PS-25 150 W	PS-30 200 W	PS-30 300 W
None	T3	T2D	T2C	325
Standard Dome	T2D	T2C	T2B	325
30° Angle	T2C	T2C	T2B	325

Fixture Ambient Suitability: Class I, Division 2, Groups A, B, C, D

Fixture Ambient Suitability: Class II, Groups E, F, G; Class III; Enclosure 4X

Areas	°C	°F	Fixture	Watts
Non-Classified	75	167	A-23	60 to 300
Classified	40	104	PS-30	60 to 300

① With heat-resistant glass globes or plastic globes.

② 300 W PS-25 not approved for Class II, Division 1 and 2, Group G; Class III.

V-51™ Incandescent Luminaires

Enclosed and Gasketed





UNILETS® for use with threaded metal conduit. Fixtures suitable for use in wet locations. ①

NEC:
Class I, Division 2, Groups A, B, C, D

CEC:
Class I, Division 2, Groups A, B, C, D
Class II, Divisions 1 and 2, Groups E, F, G ②
Class III
Enclosure 3R

Appleton

INCANDESCENT/AREA: NEC/CEC ENCLOSED AND GASKETED

Malleable Mounting Hood, Adapter and Guard	Type	Lamp Watts	Size (Inches)	All Malleable with Guard ③
Pendant				
	A-21	60-150	1/2	VA1050G-M
			3/4	VA1075G-M
			1	VA1100G-M
			1-1/4	VA1125G-M
	PS-30	150-300	1/2	VA2050G-M
			3/4	VA2075G-M
			1	VA2100G-M
			1-1/4	VA2125G-M
Ceiling — Five Tapped Openings — Four close-up plugs				
	A-21	60-150	1/2	VXHA1050G-M
			3/4	VXHA1075G-M
			1	VXHA1100G-M
			1/2	VXHA2050G-M
	PS-30	150-300	3/4	VXHA2075G-M
			1	VXHA2100G-M
Wall — JB Box Mounting ④ — Fits JB cast outlet box ⑤ — Screws and gasket furnished with fixture				
	A-21	60-150		JBW10G-M
	PS-30	150-300		JBW20G-M
Ceiling — JB Box Mounting ④ — Fits JB cast outlet box ⑤ — Screws and gasket furnished with fixture				
	A-21	60-150		JB10G-M
	PS-30	150-300		JB20G-M

① With heat-resistant glass globes or plastic globes.

② 300 W PS-25 not approved for Class II, Division 1 and 2, Group G; Class III.

③ To order fixtures without guards, omit -G suffix from catalog number. Order reflectors and accessories separately.

④ 30° angle reflector adaptable for 100 W fixture only, when mounted at least 114.3 mm (4.5") from wall.

⑤ JB cast outlet box is available in the Fitting Section.









V-51™ Incandescent Luminaires

Enclosed and Gasketed

UNILETS® for use with threaded metal conduit.

NEC:
Class I, Division 2, Groups A, B, C, D

CEC:
Class I, Division 2, Groups A, B, C, D
Class II, Divisions 1 and 2, Groups E, F, G ②
Class III
Enclosure 3R

Description	Hub Size (Inches)	Catalog Numbers Malleable Iron
Pendant and Ceiling Mounting Hoods — Furnished with connection block, gasket and screws		
Pendant Mounting		
	1/2	VA50
	3/4	VA75
	1	VA100
	1-1/4	VA125
Dead-End — Ceiling Mounting		
	1/2	V50
	3/4	V75
Feed-Thru — Ceiling Mounting		
	1/2	VC50
	3/4	VC75
Three Hubs — Ceiling Mounting		
	1/2	VT50
	3/4	VT75
Four Hubs — Ceiling Mounting		
	1/2	VX50
	3/4	VX75
Five Hubs — Ceiling Mounting ③		
	1/2	VXHA50
	3/4	VXHA75
	1	VXHA100
Wall and Stanchion Mounting Hoods — Furnished with connection block, gasket and screws		
One Opening — Wall Mounting ④ — 1 tapped hole in center of flange		
	1/2	VGA50
	3/4	VGA75
Feed-Thru — Wall Mounting ④ — 2 tapped vertical feed-thru hubs		
	1/2	VD50
	3/4	VD75
Three Hubs and One Opening — Wall Mounting ④ — 3 hubs plus 1 tapped opening in center of flange		
	1/2	VGAT50
	3/4	VGAT75

② 300 W PS-25 not approved for Class II, Division 1 and 2, Group G; Class III.

③ Four close-up plugs furnished.

④ Mounting hoods for wall installations can only be used with 30° angle reflectors.

V-51™ Incandescent Luminaires

Enclosed and Gasketed













UNILETS® for use with threaded metal conduit.

NEC:
Class I, Division 2, Groups A, B, C, D

CEC:
Class I, Division 2, Groups A, B, C, D
Class II, Divisions 1 and 2, Groups E, F, G ②
Class III
Enclosure 3R

Appleton

INCANDESCENT/AREA: NEC/CEC ENCLOSED AND GASKETED

Wall	Ceiling	Type	Catalog Numbers Malleable Iron	
Wall and Ceiling Outlet Box Mounting Hoods				
		SEH ③ and 3-1/4" or 4" Octagonal Outlet Box Mounting ④ for Non-Classified Areas Only Wall ⑤ Ceiling	0BWW1 0BV1	
		GS Round Base Outlet Box Mounting – Form 20 ③ Wall ⑤ Ceiling	GSW2 GS2	
		JB Round Base Outlet Box Mounting ③ Wall ⑤ Ceiling	JBW1 JB1	
A21	PS30	Type	Lamp Watts	Catalog Numbers Malleable Iron
Fixture Units				
		Adapter/Socket, Globe and Guard A21 PS30	60-150 150-300	VU100M VU200M
		Adapter/Socket and Globe A21 PS30	60-150 150-300	VU100MLG VU200MLG
		Adapter/Socket A21 PS30	60-150 150-300	VAD-1M ⑥ VAD-2M ⑥

② 300 W PS-25 not approved for Class II, Division 1 and 2, Group G; Class III.

③ Cast outlet boxes and gaskets are available in the Fitting Section. Screws, gasket and adapter plate furnished with fixture mounting hood.

④ Octagonal outlet boxes are available in the Commercial Fitting Section. Screws, gasket and adapter plate furnished with fixture mounting hood.

⑤ Mounting hoods for wall installations can only be used with 30° angle reflectors.

⑥ Accepts steel wire guard only





V-51™ Incandescent Luminaires

Enclosed and Gasketed

UNILETS® for use with threaded metal conduit.

NEC:
Class I, Division 2, Groups A, B, C, D

CEC:
Class I, Division 2, Groups A, B, C, D
Class II, Divisions 1 and 2, Groups E, F, G ②
Class III
Enclosure 3R

		Type	Lamp Watts	Catalog Numbers	
				Glass — 60–150 W	Polycarbonate – 100 W Max. ③
Glass and Polycarbonate Globes — 60-150 W					
		Clear		VGL-1CL	VPG-1CL
		Amber		VGL-1AM	VPG-1AM
		Blue		VGL-1BL	VPG-1BL
		Green		VGL-1GR	VPG-1GR
		Opal		VGL-1OP	—
		Red		VGL-1RE	VPG-1RE
60 W–150 W Glass	100 W Polycarbonate	Clear Heat-Resistant		VGL-1HR	—
Glass Globes — 150-300W					
		Clear		VGL-2CL	—
		Amber		VGL-2AM	—
		Blue		VGL-2BL	—
		Green		VGL-2GR	—
		Opal		VGL-2OP	—
		Red		VGL-2RE	—
		Clear Heat-Resistant		VGL-2HR	—
Steel Wire Guards ④					
		A21 ⑤	60-150		VWG-1
		PS30 ⑥	150-300		VWG-2
VWG-1					

② 300 W PS-25 not approved for Class II, Division 1 and 2, Group G; Class III.
 ③ Do not use in ambients exceeding +25° C (+77 °F). For burning in base-up position only.
 ④ Cannot be used with polycarbonate globes.
 ⑤ Fits VAD-1M Adapter
 ⑥ Fits VAD-2M Adapter









V-51™ Incandescent Luminaires

Enclosed and Gasketed

UNILETS® for use with threaded metal conduit.

NEC:
Class I, Division 2, Groups A, B, C, D

CEC:
Class I, Division 2, Groups A, B, C, D
Class II, Divisions 1 and 2, Groups E, F, G ②
Class III
Enclosure 3R

Description	Type	Lamp Watts	Catalog Number
Porcelain Reflectors — Furnished with neoprene attaching ring			
Standard Dome			
	A21	60-150	VRW-1ST
	PS30	150-300	VRW-2ST
30° Angle			
	A21	60-150	VRW-1AN
	PS30	150-300	VRW-2AN
Replacement Reflector Attaching Ring — Neoprene			
			VPT-8
Connection Block			
			VPT-7
Lamp Socket — Medium Base			
			VPT-1AV
Gasket for Lamp Socket and 60-150 W Globe			
			VPT-2
Gasket for 150-300 W Globe			
			VPT-3
Gasket for Mounting Hood			
			VPT-4

② 300 W PS-25 not approved for Class II, Division 1 and 2, Group G; Class III.

V-51™ Incandescent Luminaires

Enclosed and Gasketed

UNILETS® for use with threaded metal conduit.

NEC:
Class I, Division 2, Groups A, B, C, D

CEC:
Class I, Division 2, Groups A, B, C, D
Class II, Divisions 1 and 2, Groups E, F, G ②
Class III
Enclosure 3R

Dimensions in Millimeters (Inches)

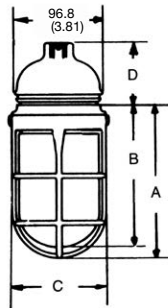

Type VA

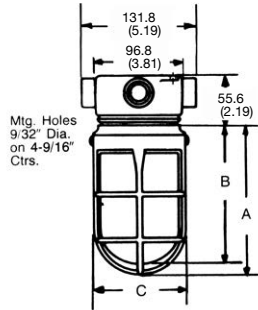

Types V, VC, VT and VX

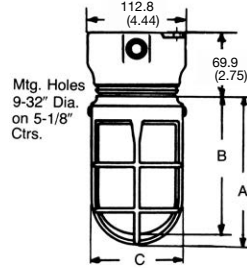

Type VXHA

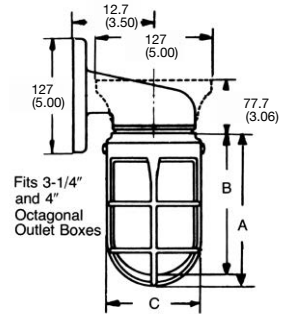

Types OBV and OBVW

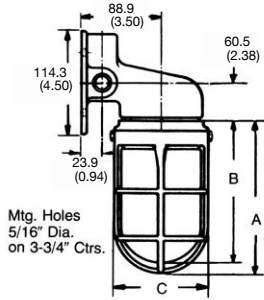

Types VGA and VGAT

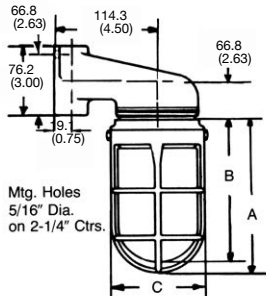

Type VD

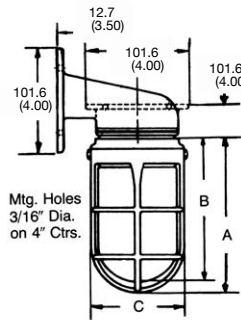

Types JB and JBW

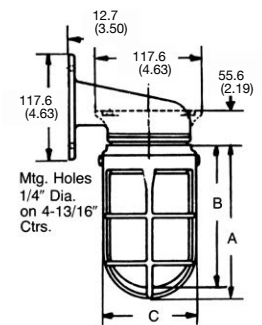

Types GS and GSW

Size	A	B	C	1/2 and 3/4 D	1 and 1-1/4 D
60-150 W	162.1 (6.38)	146.1 (5.75)	106.4 (4.19)	66.8 (2.63)	73.4 (2.89)
150-300 W	241.3 (9.50)	219.2 (8.63)	144.5 (5.69)	66.8 (2.63)	73.4 (2.89)

Reflectors

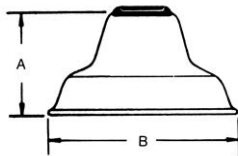

Standard Dome

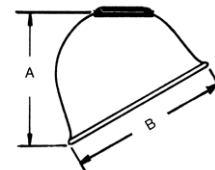

30 Angle

Size	Standard Dome		30 Angle	
	A	B	A	B
60-150 W	157.2 (6.19)	304.8 (12.00)	205.5 (8.09)	254.0 (10.00)
150-300 W	225.6 (8.88)	406.4 (16.00)	294.4 (11.59)	304.8 (12.00)

© 300 W PS-25 not approved for Class II, Division 1 and 2, Group G; Class III.

Visit our website at www.emerson.com or contact us at (800) 621-1506.
© May 2016

V-51™ Incandescent Luminaire

Enclosed and Gasketed

UNILETS® for use with threaded metal conduit. Full-size photometric data available for all V-51® fixtures on request.

NEC:
Class I, Division 2, Groups A, B, C, D

CEC:
Class I, Division 2, Groups A, B, C, D
Class II, Divisions 1 and 2, Groups E, F, G ②
Class III
Enclosure 3R

Photometric Data

Without Reflector

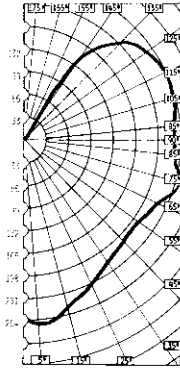

Effective Floor Cavity Reflectance (Rfc) is 20%

% Ceiling Rcc	Effective Floor Cavity Reflectance (Rfc) is 20%																
	80		70		50		30		10		0						
% Walls Rw	50	30	10	50	30	10	50	30	10	50	30	10	0				
ROOM CAVITY RATIOS	1	.815	.765	.721	.755	.711	.668	.642	.608	.577	.539	.513	.489	.444	.424	.406	.360
	2	.690	.619	.558	.639	.575	.521	.542	.492	.449	.452	.414	.380	.370	.341	.315	.273
	3	.595	.515	.450	.551	.478	.421	.467	.410	.362	.388	.344	.307	.316	.282	.252	.215
	4	.523	.439	.374	.485	.409	.350	.411	.351	.303	.343	.296	.257	.279	.242	.212	.178
	5	.457	.376	.313	.426	.350	.292	.362	.300	.254	.302	.253	.215	.246	.208	.177	.147
	6	.409	.326	.266	.378	.303	.248	.322	.261	.215	.269	.220	.183	.220	.180	.150	.123
	7	.364	.283	.229	.338	.264	.213	.288	.226	.184	.240	.192	.155	.198	.158	.128	.104
	8	.329	.251	.197	.305	.234	.185	.260	.202	.160	.220	.171	.136	.179	.141	.112	.090
	9	.298	.223	.171	.277	.208	.161	.237	.180	.140	.199	.152	.119	.164	.126	.098	.078
	10	.271	.198	.152	.251	.187	.142	.216	.161	.123	.182	.137	.104	.151	.113	.086	.068

Standard Dome

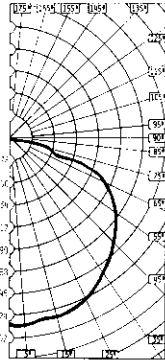
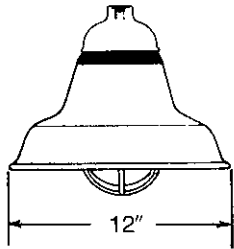

Effective Floor Cavity Reflectance (Rfc) is 20%

% Ceiling Rcc	Effective Floor Cavity Reflectance (Rfc) is 20%																
	80		70		50		30		10		0						
% Walls Rw	50	30	10	50	30	10	50	30	10	50	30	10	0				
ROOM CAVITY RATIOS	1	.803	.772	.744	.784	.756	.731	.750	.726	.706	.718	.701	.683	.691	.675	.661	.645
	2	.705	.656	.614	.690	.645	.608	.661	.624	.591	.636	.605	.576	.612	.586	.562	.546
	3	.618	.558	.511	.606	.550	.506	.583	.535	.495	.560	.520	.486	.540	.506	.476	.460
	4	.549	.484	.434	.538	.478	.430	.518	.465	.423	.499	.454	.417	.482	.442	.410	.393
	5	.485	.416	.366	.475	.411	.363	.459	.401	.359	.442	.392	.354	.427	.384	.349	.333
	6	.431	.362	.314	.423	.358	.310	.408	.350	.307	.394	.343	.304	.382	.335	.299	.284
	7	.384	.316	.270	.377	.311	.267	.364	.304	.263	.351	.299	.260	.341	.294	.257	.242
	8	.347	.281	.234	.340	.278	.233	.329	.272	.231	.319	.267	.229	.309	.262	.226	.212
	9	.314	.249	.204	.309	.246	.204	.299	.242	.202	.289	.237	.200	.281	.233	.198	.184
	10	.284	.221	.181	.279	.221	.181	.271	.216	.179	.263	.212	.176	.257	.209	.174	.161

30° Angle

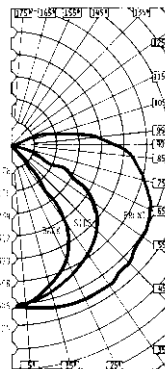
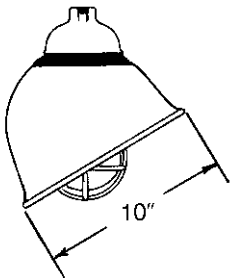

Photometric data shown on this page is based on a 150 Watt PS-25 lamp and is representative of the performance for all V-51 incandescent fixtures. For candlepower values of fixtures with other lamps, multiply the given candlepower values by the following multipliers: for 60 W – A19 X 0.33; for 75 W – A19 X 0.45; for 100 W – A19 X 0.66; for 200 W – PS25 X 1.44; and for 300 W – PS30 X 2.32. For candlepower values of fixture with guard, multiply by 0.90.

© 300 W PS-25 not approved for Class II, Division 1 and 2, Group G; Class III

REA 150 W Incandescent Luminaires^①

Enclosed and Gasketed

UNILETS® for use with Threaded Metal Conduit. Medium Base. Inexpensive, Low Wattage Fixture for use in Wet Locations.

NEC:

Rated for Ordinary (Unclassified) Locations

Applications

- Vaportight enclosed and gasketed lighting fixtures, suitable for use in wet locations.
- Standard glass globes take up to 150 W A-21 lamps. Optional polycarbonate plastic globes take up to 100 W A-21 lamps.

Features

- Inexpensive fixture designed for use without reflector.
- Spring-mounted shock-absorbing socket prolongs lamp life.
- Guards snap on easily and securely. Spring-action balls snap into detents in fixture body.

Standard Materials

- Mounting bodies: pressure cast copperfree (4/10 of 1% max.) aluminum
- Socket: porcelain with brass screw shell
- Guards: steel or aluminum guards

Standard Finishes

- Mounting bodies: burnished
- Steel wire guard: zinc electroplate
- Aluminum guard: aluminum polymer enamel
- Socket and globes: natural finish

NEC Certifications and Compliances

- UL Standard: UL 1598



Pendant

Outlet Box

Wall

Dimensions in Millimeters (Inches)

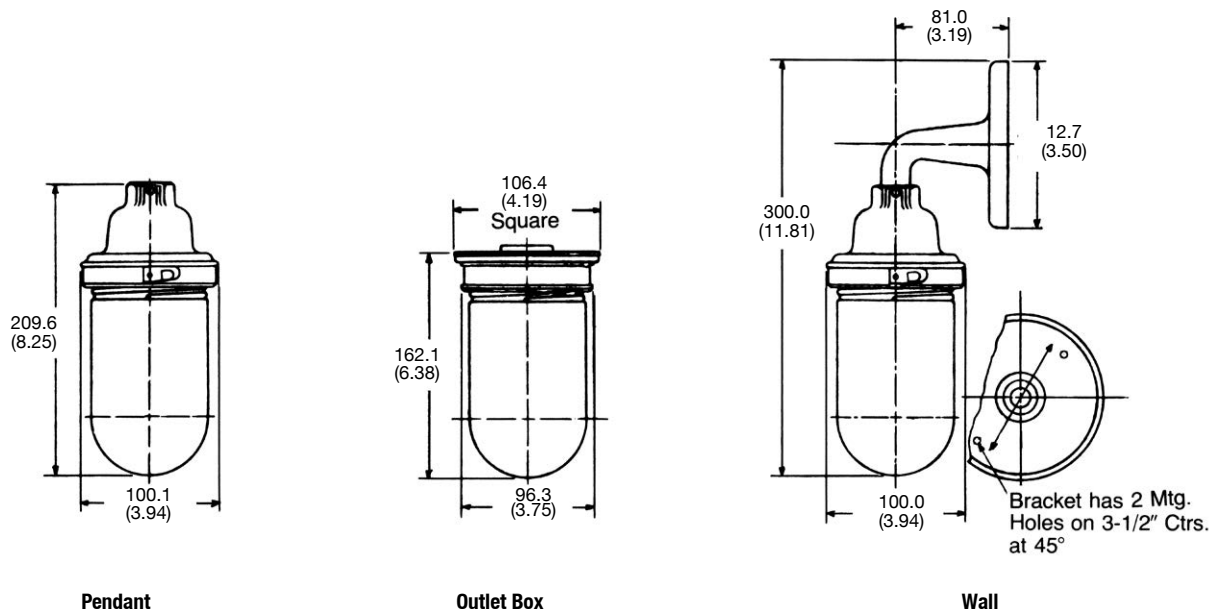







① Maximum size A-21 lamp: glass globe – 150 Watts; plastic globe – 100 Watts. No reflectors are available for REA fixtures.



REA 150 W Incandescent Luminaires ^①

Enclosed and Gasketed

UNILETS[®] for use with Threaded Metal Conduit. Medium Base. Inexpensive, Low Wattage Fixture for use in Wet Locations.

NEC:
Rated for Ordinary (Unclassified) Locations

		Description	Hub Size (Inches)	Catalog Number
 Pendant	 Outlet Box	Pendant Fixture	1/2	REA-1050
			3/4	REA-1075
		Outlet Box Fixture For 3-1/4" or 4" octagonal, or 4" square mounting.		REA-10B
 Wall		Wall Fixture		REA-10LB
		Pendant Hood	1/2 3/4	REA-50 REA-75
		Wall Bracket	1/2 male stem	REA-1BR
		Lamp Socket		VPLR-123
 VWG-1	 VGU-1	Steel Guard For Outlet Box fixture only.		VWG-1
		Aluminum Guard For Pendant and Wall Mount fixtures only.		VGU-1

		Description	Catalog Number ^①	
			Glass	Plastic
Colored Glass and Polycarbonate Globes				
 Glass	 Plastic	Clear	VGL-1CL	VPG-1CL
		Amber	VGL-1AM	VPG-1AM
		Blue	VGL-1BL	VPG-1BL
		Green	VGL-1GR	VPG-1GR
		Opal	VGL-1OP	—
		Red	VGL-1RE	VPG-1RE
		Clear Heat-Resistant	VGL-1HR	—

^① Maximum size A-21 lamp: glass globe – 150 Watts; plastic globe – 100 Watts. No reflectors are available for REA fixtures.

Code•Master™ Incandescent Factory Sealed Luminaires

Explosionproof, Dust-Ignitionproof

For use with threaded metal conduit.

NEC:

Class I, Division 1, Groups C, D
Class II, Division 1 and 2, Groups E, F, G
Class III
NEMA 3R, 4X

Applications

- For use in hazardous locations such as plants where plastics, paints, thinners and petrochemicals are manufactured.
- For use in chemical and petrochemical plants, such as manufacturers of plastics, paints and thinners, in refineries, and in other areas where ignitable vapors, dust, moisture and corrosive elements may be present.
- Suitable for outdoor saltwater locations and for other wet locations.

Features

- Fixtures operate safely in high ambient temperatures.
- Patented “wireless” design. Threading of fixture unit onto mounting hood makes electrical connection. The only wiring required is attaching two wires to connection block in mounting hood.
- Connection block is easily wired: (a) loosen two screws; (b) make wire connections; and (c) re-position connection block.
- Safe, easy servicing without disconnecting any wiring. “Wireless” fixture unit threads off mounting hood for convenient servicing or for immediate replacement with a “stand-by” unit.
- Acme double-lead threads speed installation and fixture removal from mounting hood – only half as many turns are required as for single-lead threads. The threads do not stick or gall, eliminating problems often encountered with single-lead threads during fixture unit removal.
- Strategic location of lamp socket, in combination with interior prism design of the glass globe, provides optimum light distribution and control.
- Heat- and impact-resistant globes have smooth dust-resistant exterior.
- Superior corrosion resistance, with epoxy powder coat finish.
- Porcelain socket with nickel-plated phosphor bronze screw shell. Assures long trouble-free operation in high ambient areas.
- Choice of mountings: pendant, ceiling, bracket and stanchion.
- Fiberglass-reinforced polyester reflectors, in standard dome or 30° angle styles, are ideal in installations where luminaire is subject to exceptionally severe corrosive atmospheres.
- All threaded joints are flame-tight.
- Heat- and impact-resistant globes have smooth dust-resistant exterior.
- Superior corrosion resistance, with epoxy powder coat finish.
- Optional guards protect globes from damage. Secured to fixture with three stainless steel screws.
- Medium base lamp socket.
- Maximum voltage 250 Vac 50/60 Hz.



Standard Materials

- Fixture housing, mounting hoods and guards: copperfree (4/10 of 1% max.) aluminum
- Globes: prismatic glass
- Reflectors: fiberglass reinforced polyester

Standard Finishes

- Fixture housing, guards and mounting hoods: epoxy power coat finish, electrostatically applied for complete, uniform corrosion protection

Options

- Add suffix **-Z** for Exd IIB + H₂, Zone 1.

NEC Certifications and Compliances

- UL Standard: UL 1598, UL 1598A, UL 844
- UL Listed: E10444

Appleton®

INCANDESCENT/AREA: NEC/CEC EXPLOSIONPROOF

Code•Master™ Incandescent Factory Sealed Luminaires

Explosionproof, Dust-Ignitionproof

For use with threaded metal conduit.

NEC:
 Class I, Division 1, Groups C, D
 Class II, Division 1 and 2, Groups E, F, G
 Class III
 NEMA 3R, 4X

Order using catalog numbering guide below or select catalog number from tables on following pages.

Catalog Numbering Guide

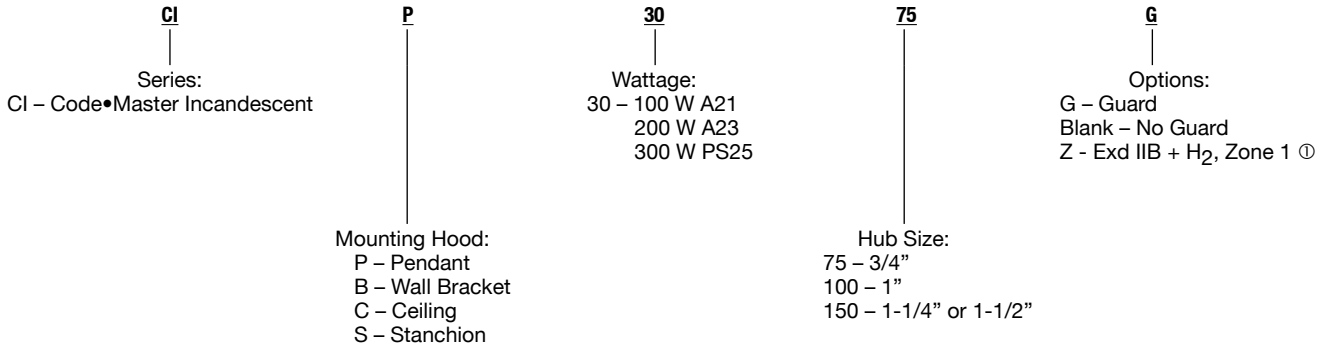

Appleton

Technical Data Thermal Suitability of Code•Master Incandescent Fixture.

Lamp Type	Lamp Watts (Max.)	Use Wire Supply °C (°F)	Ambient Temperature °C (°F)	Class I, Division 1, Groups C and D	Class II, Division 1, Groups E, F and G
Incandescent (A21)	100	75 (167)	40 (140)	T5	T3C
Incandescent (A23)	200	75 (167)	40 (140)	T4	T3C
Incandescent (PS25)	300	75 (167)	40 (140)	T3C	T3C

“T” Numbers Represent the Maximum External Temperature for Class I, Division 1 Locations and Maximum Surface Temperature Under Dust Blanket for Class II, Division 1 Locations.

“T” Number	T1	350	325	T2	T2A	T2B	T2C	T2D	T3	T3A	T3B	T3	T4	T4A	T5	T6
Temp Range (°C)	351-450	326-350	301-325	281-300	261-280	231-260	216-230	201-215	181-200	166-180	161-165	136-160	121-135	101-120	86-100	85
Temp Range (°F)	664-842	619-662	574-617	538-572	502-536	448-500	421-446	394-419	358-392	331-356	322-329	277-320	250-275	214-248	187-212	185

NOTE: The maximum operating temperature of the fixture must not exceed the ignition temperature of the gas, vapor or dust to be encountered per the National Electrical Code and the Canadian Electrical Code.

① Certified to meet the Canadian Electrical Code (CEC) only.

Code•Master™ Incandescent Factory Sealed Luminaires

Explosionproof, Dust-Ignitionproof

For use with threaded metal conduit.

NEC:

Class I, Division 1, Groups C, D
 Class II, Division 1 and 2, Groups E, F, G
 Class III
 NEMA 3R, 4X

		Type Mounting	Hub Size (Inches)	Catalog Number ③	
Pendant					
	One Hub Rigid Conduit.	3/4		CIP3075	
		1		CIP30100 ②	
Ceiling					
	Four Hubs Three Close-Up Plugs Rigid Conduit	3/4		CIC3075	
		1		CIC30100 ②	
Wall Bracket					
	Four Hubs Three Close-Up Plugs Rigid Conduit	3/4		CIB3075	
		1		CIB30100 ②	
25° Stanchion					
	One Hub	1-1/2		CIS30150	
Mounting Hoods					
		Type Mounting	Hub Size (Inches)	Hood Weight kg (lb)	Catalog Number
Pendant					
	One Hub Rigid Conduit	3/4		0.9 (1.98)	CAP-75
		1		0.9 (1.98)	CAP-100 ②
Ceiling					
	Four Hubs Three Close-Up Plugs Rigid Conduit	3/4		1.8 (3.97)	CAC-75
		1		1.8 (3.97)	CAC-100 ②
Bracket					
	Four Hubs Three Close-Up Plugs Rigid Conduit	3/4		2.7 (5.95)	CALB-75
		1		2.7 (5.95)	CALB-100 ②
25° Stanchion					
	One Hub	1-1/4 or 1-1/2 ①		0.9 (1.98)	CAS-150 ①

① 1-1/2" Tapped hub furnished with 1-1/2" to 1-1/4" reducer.
 ② 1" Hubs are listed for Group D only.
 ③ Catalog numbers shown are supplied with clear lens. Add suffix **G** for optional Guard.

Appleton®







INCANDESCENT/AREA: NEC/CEC EXPLOSIONPROOF

Code•Master™ Incandescent Factory Sealed Luminaires

Explosionproof, Dust-Ignitionproof

For use with threaded metal conduit.

NEC:
Class I, Division 1, Groups C, D
Class II, Division 1 and 2, Groups E, F, G
Class III
NEMA 3R, 4X

	Description	Weight kg (lb)	Catalog Number
Fixture Unit Only			
	Not including mounting hood	5.0 (11.02)	CJNC30I
Optional White Polyester Reflector			
	Standard Dome	1.1 (2.43)	KR2-ST
Optional White Polyester Reflector			
	Angled Reflector	1.1 (2.43)	KR2-AN
Optional Aluminum Guard			
		0.2 (0.44)	CJGU-15
Optional Three Way Exit Sign			
		3.4 (7.50)	CJEXRN
Replacement Connection Block			
		0.2 (0.44)	VPT-7

Appleton®

INCANDESCENT/AREA: NEC/CEC EXPLOSIONPROOF

Code•Master™ Incandescent Factory Sealed Luminaires

Explosionproof, Dust-Ignitionproof

For use with threaded metal conduit.

NEC:

Class I, Division 1, Groups C, D
 Class II, Division 1 and 2, Groups E, F, G
 Class III
 NEMA 3R, 4X

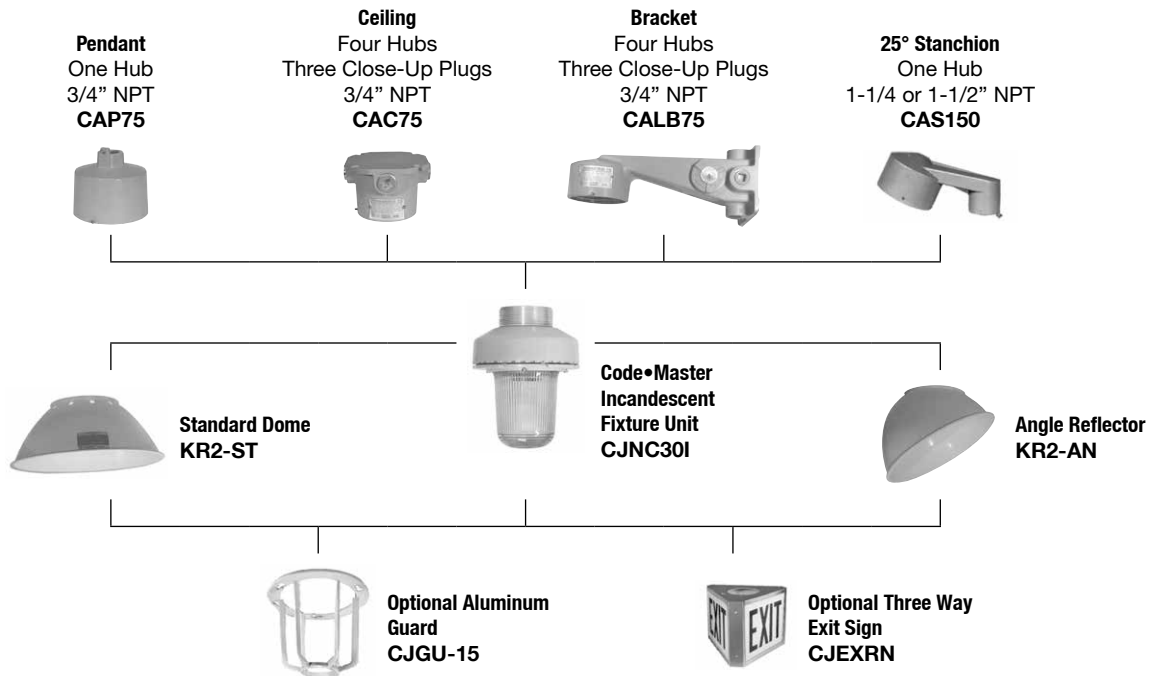

Dimensions in Millimeters (Inches)

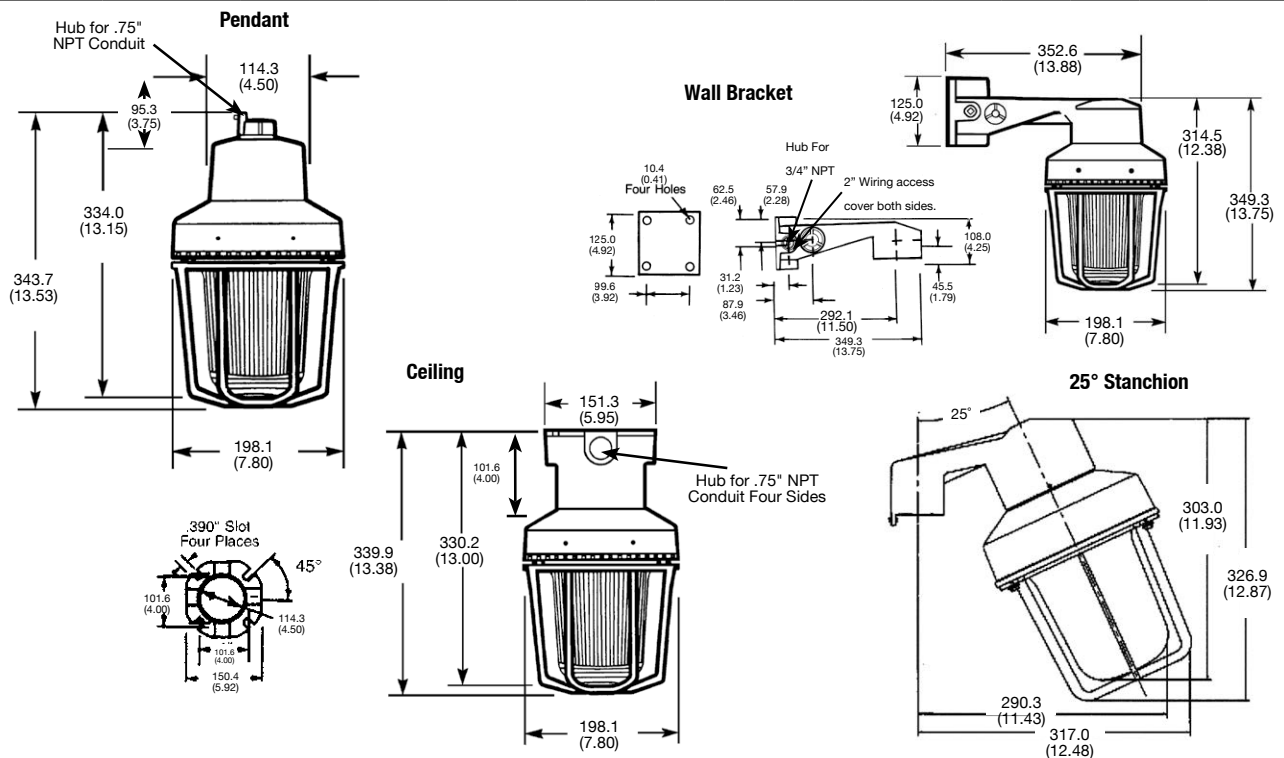

A-51™ Incandescent Factory Sealed Luminaires

Explosionproof

Suitable for use in Wet Locations. UNILETS® for use with Threaded Metal Conduit.

NEC/CEC — For Group A and B:
Class I, Division 1 and 2, Groups A, B, C, D
Class II, Division 1 and 2, Groups E, F, G
Class III

NEC/CEC — For Group C and D:
Class I, Division 1 and 2, Groups C, D
Class II, Division 1 and 2, Groups E, F, G
Class III

Applications

- A-51 Series Incandescent Class I, Groups A, B, C and D; and Class II, Groups E, F and G applications (see listings and area suitability chart).
- Ideal for use in chemical and petrochemical plants, and in other heavy process areas where ignitable vapors, dust, moisture and corrosive atmospheres may be present.
- Suitable for use in wet locations.
- Wide range of wattages – 60 W through 300 W incandescent lamps.
- Choice of units with or without guard, as well as choice of porcelain, polyester or aluminum reflectors.
- Choice of mountings: pendant, ceiling, 25° stanchion, long bracket and 15° short bracket.
- Porcelain reflectors for standard applications and fiberglass reinforced polyester reflectors for installations where fixture is subject to exceptionally severe corrosive atmospheres. High bay reflector for installations where mounting height from work plane ranges from 762 mm (20 to 30 ft/508 in).
- Class I, Groups A and B fixtures have special UL-approved sintered metal flame arrester.

Features

- All A-51 fixtures are factory-sealed; no external sealing fittings required.
- New high temperature phenolic connection block in mounting hood has rugged leaf spring contacts – loosen two screws, rotate and remove for quick wiring.
- Safe, easy servicing or relamping without disconnecting any wiring. “Wireless” fixture unit easily threads off mounting hood for convenient servicing or for immediate exchange with “stand-by” unit.
- All joints are flame-tight.
- Specially formulated two-coat baked epoxy enamel provides superior protective finish to resist corrosion. Applied to all mounting hoods, fixture units and guards.
- New high temperature glass-reinforced phenolic socket block in fixture unit has collector ring and pin that automatically make electrical contact as fixture unit is threaded onto mounting hood.
- Globes in A-51 fixtures are explosionproof and heat- and impact-resistant glass. Prismatic configuration on globe interior provides light control while allowing smooth exterior surface for cleaning.
- A-51 fixture units have standardized threads to fit all A-51 and mounting hoods.
- All fixtures have aluminum inner reflector for increased lumen efficiency.
- A-51 fixture guards to protect globe are of rugged copperfree aluminum construction and double epoxy coated. Easily mount to globe ring with 3 screws.

Standard Materials

- Fixtures and guards: copperfree (4/10 of 1% max.) aluminum.
- Pendant mounting hoods: copperfree (4/10 of 1% max.) aluminum.
- Ceiling and bracket mounting hoods: malleable iron with aluminum adapters.
- Reflectors: porcelain-enameled steel, aluminum or fiberglass reinforced polyester.

Group A and B



Polyester Reflector



Porcelain Reflector



Group C and D



Polyester Reflector



Porcelain Reflector



Standard Finishes

- Fixtures, guards and mounting hoods: two-coat epoxy-clad finish. Epoxy powder coat finish, electrostatically applied for complete, uniform surface protection.
- Steel reflectors: white porcelain enamel.
- Polyester and aluminum reflectors: natural finish.

NEC/CEC Certifications and Compliances

- UL Standard: UL 1598, UL 844
- UL Listed: E10444
- CSA Standard: C22.2 No. 250, C22.2 No. 137
- CSA Certified: 025428

A-51™ Incandescent Factory Sealed Luminaires

Explosionproof

Suitable for use in Wet Locations. UNILETS® for use with Threaded Metal Conduit.

NEC/CEC:

Class I, Division 1 and 2, Groups A, B, C, D.
Class II, Division 1 and 2, Groups E, F, G
Class III

Illustrated Features

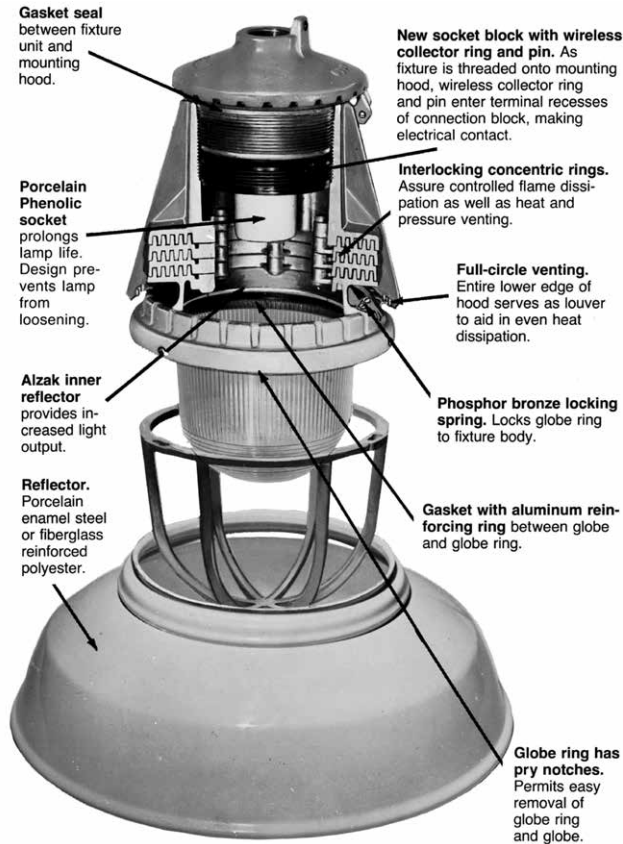

Alzak® is a proprietary term of the Aluminum Company of America.

Weights

Fixture Units		
Wt. kg (lbs)		Catalog Number
3.4 (7.6)		AAU-1N
3.4 (7.6)		AAU-15N
4.9 (10.7)		AAU-2NS
9.2 (20.3)		AAU-5NS
6.8 (15.0)		AAUA-15
8.2 (18.0)		AAUA-2

Mounting Hoods		
Type		Wt. kg (lbs)
Pendant		0.6 (1.3)
Ceiling		2.2 (4.8)
Stanchion		0.7 (1.6)
Long Bracket		4.0 (8.9)
Short Bracket		2.2 (4.8)

Guards		
Wt. kg (lbs)		Catalog Number
0.2 (0.4)		AAGU-1
0.4 (0.8)		AAGU-2
0.9 (1.9)		AAGU-5
0.2 (0.5)		AAGUA-15

Standard Reflectors		
Wt. kg (lbs)		Catalog Number
1.3 (2.8)		AARP-2ST
1.0 (2.1)		AARW-15ST
1.3 (2.9)		AARW-2ST
2.0 (4.3)		AARW-5ST
1.0 (2.1)		AARW-15ST

30° Angle Reflectors		
Wt. kg (lbs)		Catalog Number
1.5 (3.3)		AARP-2AN
1.0 (2.1)		AARW-15AN
1.1 (2.4)		AARW-2AN
3.2 (7.0)		AARW-5AN
1.0 (2.1)		AARW-15AN

High Bay Reflectors		
Wt. kg (lbs)		Catalog Number
1.3 (2.9)		AARE-2HB
1.8 (3.9)		AARE-5HB

Appleton®

INCANDESCENT/AREA: NEC/CEC EXPLOSIONPROOF

A-51™ Incandescent Factory Sealed Luminaires

Explosionproof

Suitable for use in Wet Locations. UNILETS® for use with Threaded Metal Conduit.

NEC/CEC:

Class I, Division 1 and 2, Groups A, B, C, D
 Class II, Division 1 and 2, Groups E, F, G
 Class III

Fixture Unit	Lamp Watts	Without Reflectors	Standard Dome	30° Angle	High Bay	Supply Wire °C (°F)
Class I Division 1 and Division 2 Groups C and D						
AAU1N	100 W A19	T5	T5	T5	—	125 (257)
	100 W A21	T5	T5	T5	—	125 (257)
AAU15N	150 W A23	T3C	T3C	T3C	—	125 (257)
	200 W A25	T3C	T3C	T3C	—	125 (257)
	200 W PS25	T3C	T3C	T3C	—	125 (257)
	300 W PS25	T3C	T3A	T3A (D)	—	125 (257)
AAU2NS	200 W PS25	T3C	T3C	T3C	—	110 (230)
	200 W PS30	T3C	T3C	T3C	—	110 (230)
	300 W PS25	T3C	T3C	T3C	—	110 (230)
	300 W PS30	T3C	T3C	T3C	—	110 (230)
Class I Division 1 and Division 2 Groups A ①, B, C and D						
AAUA15	150 W A23	T3C	T3C	T3C	—	110 (230)
	150 W A25	T3C	T3C	T3C	—	110 (230)
	200 W A25	T3C	T3C	T3C	—	110 (230)
	200 W PS25	T3C	T3C	T3C	—	110 (230)
AAUA2	200 W PS25	T3C	T3C	T3C	—	110 (230)
	200 W PS30	T3C	T3C	T3C	—	110 (230)
	300 W PS25	T3C	T3C	T3C	—	110 (230)
	300 W PS30	T3C	T3C	T3C	—	110 (230)
Class II Division 1 and Division 2 Groups E, F and G						
AAU1N	100 W A19	T3C	T3C	T3C	—	125 (257)
	100 W A21	T3C	T3C	T3C	—	125 (257)
AAU15N	150 W A23	T3C	T3C	T3C	—	125 (257)
	200 W A25	T3C	T3C	T3C	—	125 (257)
	200 W PS25	T3	T3	T3	—	125 (257)
	300 W PS25	T3	—	—	—	125 (257)
AAU2NS	200 W PS25	T3C	T3C	T3C	—	110 (230)
	200 W PS30	T3C	T3C	T3C	—	110 (230)
	300 W PS25	T3C	T3C	T3A (EF)	—	110 (230)
	300 W PS30	T3C	T3C	T3A (EF)	—	110 (230)

NOTE: Ambient suitability of these incandescent fixtures: +40 °C (+104°F)

① For Group A, use Pendant Mount only.



A-51™ Incandescent Factory Sealed Luminaires

For Group C and D Locations. Explosionproof

Suitable for use in Wet Locations. UNILETS® for use with Threaded Metal Conduit.

NEC/CEC:

Class I, Division 1 and 2, Groups C, D
Class II, Division 1 and 2, Groups E, F, G
Class III

Type		Hub Size (Inches)	Catalog Number ②	
Pendant — One Hub, Rigid or Flexible Mounting				
	60-100 W (AAU-1N) A-21	1/2	AP1050	
		3/4	AP1075	
		1	AP10100	
	150-300 W (AAU-15N) A-23 PS-25	1/2	AP1550	
		3/4	AP1575	
		1	AP15100	
	200-300 W (AAU-2NS) PS-30	1/2	AP2050	
		3/4	AP2075	
		1	AP20100	
Ceiling — Four Hubs, Three Close-up Plugs				
	60-100 W (AAU-1N) A-21	1/2	AC1050	
		3/4	AC1075	
		1	AC10100	
	150-300 W (AAU-15N) A-23 PS-25	1/2	AC1550	
		3/4	AC1575	
		1	AC15100	
	200-300 W (AAU-2NS) PS-30	1/2	AC2050	
		3/4	AC2075	
		1	AC20100	
25° Stanchion — One Hub — Not UL Listed				
	60-100 W (AAU-1N) A-21	1-1/2 ②	AN10150	
		150-300 W (AAU-15N) A-23 PS-25	1-1/2 ②	AN15150
			200-300 W (AAU-2NS) PS-30	1-1/2 ②

① See A-51™ Incandescent Factory Sealed Luminaire Classified Area Suitability page for suitability of specific fixtures.

② 1-1/2" tapped hub furnished with a 1-1/2" to 1-1/4" reducer.

A-51™ Incandescent Factory Sealed Luminaires





For Group C and D Locations. Explosionproof

Suitable for use in Wet Locations. UNILETS® for use with Threaded Metal Conduit.

Class I, Division 1 and 2, Groups C, D
Class II, Division 1 and 2, Groups E, F, G
Class III

Appleton®

INCANDESCENT/AREA: NEC/CEC EXPLOSIONPROOF

Type	Hub Size (Inches)	Catalog Number ②		
Long Bracket — Four Hubs, Three Close-up Plugs				
	60-100 W (AAU-1N) A-21	1/2 3/4 1	ALB1050 ALB1075 ALB10100	
	150-300 W (AAU-15N) A-23 PS-25	1/2 3/4 1	ALB1550 ALB1575 ALB15100	
	200-300 W (AAU-2NS) PS-30	1/2 3/4 1	ALB2050 ALB2075 ALB20100	
	15° Short Bracket — Two Hubs, One Close-up Plug			
		60-100 W (AAU-1N) A-21	1/2 3/4	ASB1050 ASB1075
		150-300 W (AAU-15N) A-23 PS-25	1/2 3/4	ASB1550 ASB1575
		200-300 W (AAU-2NS) PS-30	1/2 3/4	ASB2050 ASB2075
		Three-Way Exit Sign		
			Epoxy enameled steel – 152.4 mm (6 in)-high red lettering 60-200 W (Mounts to AAU-1N or AAU-15N fixture units in place of guard)	CJEXRN
Single-Sided Exit Sign				
	Epoxy enameled steel – 152.4 mm (6 in)-high red lettering 60-200 W (Mounts to AAU-1N or AAU-15N fixture units in place of guard) (See page G2-24 for dimensions)	AEXR-15R		
Guard — Add suffix to fixture catalog number				
	Guard	-G		









① See A-51™ Incandescent Factory Sealed Luminaire Classified Area Suitability page for suitability of specific fixtures.

A-51™ Incandescent Factory Sealed Luminaires

For Group C and D Locations. Explosionproof

Suitable for use in Wet Locations. UNILETS® for use with Threaded Metal Conduit.

NEC/CEC — For Group C and D:
 Class I, Division 1 and 2, Groups C, D
 Class II, Division 1 and 2, Groups E, F, G
 Class III

Mounting Hoods		
Type	Hub Size (Inches)	Catalog Number
Pendant — One Hub, Rigid or Flexible Mounting		
	1/2	AAP-50
	3/4	AAP-75
	1	AAP-100
Ceiling — Four Hubs, Three Close-up Plugs		
	1/2	AAC-50
	3/4	AAC-75
	1	AAC-100
25° Stanchion — Not UL Listed — One Hub		
	1-1/2	AAN-150 ①
Long Bracket — Four Hubs, Three Close-up Plugs		
	1/2	AALB-50
	3/4	AALB-75
	1	AALB-100
15° Short Bracket — Two Hubs, One Close-up Plug		
	1/2	AASB-50
	3/4	AASB-75
Type	Catalog Number	
Fixture Units		
	60-100 W A-21	AAU-1N
	150-300 W A-23 and PS-25	AAU-15N
	200-300 W PS-30	AAU-2NS
Prismatic Glass Globes		
	60-100 W (AAU-1N)	AAGL-1PR
	150-300 W (AAU-15N)	AAGL-1PR
	200-300 W (AAU-2NS)	AAGL-2PR
Aluminum Guards		
	60-100 W (AAU-1N)	AAGU-1
	150-300 W (AAU-15N)	AAGU-1
	200-300 W (AAU-2NS)	AAGU-2

① 1-1/2" tapped hub furnished with a 1-1/2" to 1-1/4" reducer.

A-51™ Incandescent Factory Sealed Luminaires

For Group C and D Locations. Explosionproof

Suitable for use in Wet Locations. UNILETS® for use with Threaded Metal Conduit.

NEC/CEC — For Group C and D:
 Class I, Division 1 and 2, Groups C, D
 Class II, Division 1 and 2, Groups E, F, G
 Class III

Dimensions in Millimeters (Inches)

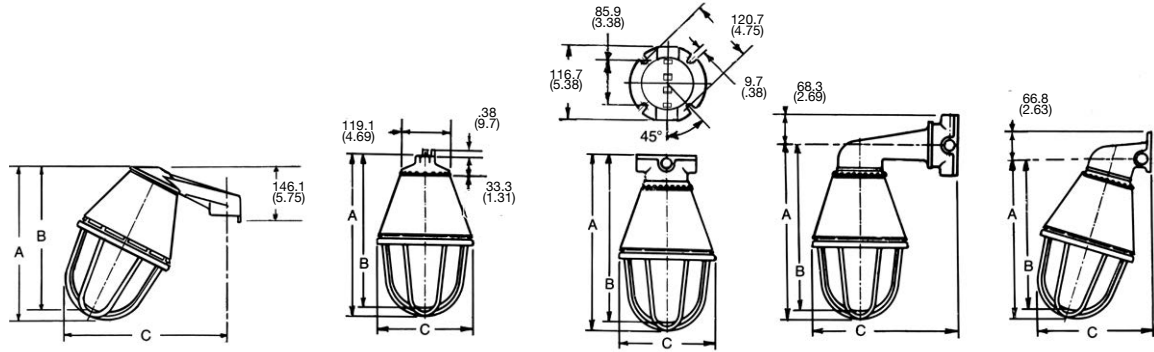

Size (Watts)	Stanchion mm (in)			Pendant ① mm (in)			Ceiling mm (in)			Long Bracket mm (in)			Short Bracket mm (in)		
	A	B	C	A	B	C	A	B	C	A	B	C	A	B	C
60-100	291.3 (11.47)	275.6 (10.85)	292.1 (11.50)	311.2 (12.25)	295.4 (11.63)	179.3 (7.06)	349.3 (13.75)	333.5 (13.13)	179.3 (7.06)	349.3 (13.75)	333.5 (13.13)	314.5 (12.38)	344.4 (13.56)	328.7 (12.94)	231.9 (9.13)
150-300	291.3 (11.47)	275.6 (10.85)	292.1 (11.50)	311.2 (12.25)	295.4 (11.63)	179.3 (7.06)	349.3 (13.75)	333.5 (13.13)	179.3 (7.06)	349.3 (13.75)	333.5 (13.13)	314.5 (12.38)	344.4 (13.56)	328.7 (12.94)	231.9 (9.13)
200-300	332.0 (13.07)	314.5 (12.38)	322.8 (12.71)	354.1 (13.94)	336.6 (13.25)	223.8 (8.81)	392.2 (15.44)	374.7 (14.75)	223.8 (8.81)	392.2 (15.44)	374.7 (14.75)	336.6 (13.25)	385.8 (15.19)	363.8 (14.50)	257.3 (10.13)

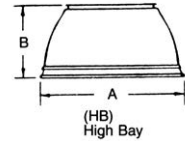
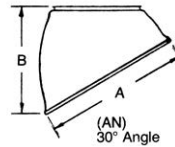
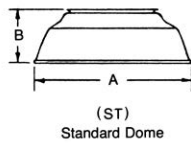

Size (Watts)	A ②	B ②	A	B	A	B
60-100	304.8 (12.00)	114.3 (4.50)	254.0 (10.00)	193.8 (7.63)	-	-
150-200	355.6 (14.00)	111.3 (4.38)	254.0 (10.00)	193.8 (7.63)	-	-
200-300	406.4 (16.00)	131.8 (5.19)	304.8 (12.00)	200.2 (7.88)	304.8 (12.00)	153.9 (6.06)

① For dimensions of fixture unit only, subtract pendant hood dimension 3.3 cm (1.31") from dimensions A and B as listed.

② Dimensions illustrated are for porcelain steel (dome and angle) and etched aluminum (high bay).

Overall dimensions for fiberglass reinforced polyester reflectors are: standard dome – 419.1 mm (16-1/2") dia., (6") (152.4) high;
 30° Angle – 374.7 mm (14-3/8") dia., 254 mm (10") high.

A-51™ Incandescent Factory Sealed Luminaires

For Group C and D Locations. Explosionproof

Photometric data shown here is based on a 200-watt type PS-30 lamp and is representative of the performance for all A-51 incandescent fixtures using 60-watt to 300-watt lamps. For candlepower values of fixtures with other lamps, use the following multipliers: 60 W A-19 - 0.23; 100 W A-19 - 0.47; 150 W A-21 - 0.75; 200 W A-23 - 1.07; 200 W A-25 - 1.02; 200 W PS-25 - 1.03; 300 W PS-25 - 1.70; W PS-30 - 1.63. To determine candlepower values of fixtures with a guard, multiply by value shown with each curve.

NEC/CEC — For Group C and D:
 Class I, Division 1 and 2, Groups C, D
 Class II, Division 1 and 2, Groups E, F, G
 Class III

Photometric Data

Effective Floor Cavity Reflectance (Rfc) is 20%

A-51 Incandescent Fixture without Reflector
 Spacing to Mtg. Ht.
 Ratio 1.25:1
 Guard .877

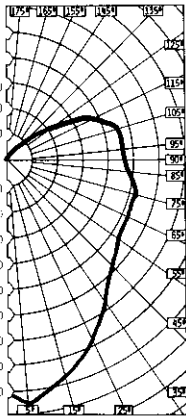

% Ceiling Rcc	Effective Floor Cavity Reflectance (Rfc) is 20%																
	80		70		50		30		10		0						
% Walls	Rw	50	30	10	50	30	10	50	30	10	50	30	10	0			
ROOM CAVITY RATIOS	1	.735	.690	.651	.695	.655	.618	.622	.590	.561	.554	.530	.506	.493	.473	.454	.422
	2	.621	.558	.503	.588	.530	.481	.525	.478	.437	.467	.430	.396	.413	.384	.357	.327
	3	.540	.468	.411	.512	.446	.394	.457	.404	.359	.406	.363	.327	.360	.325	.294	.267
	4	.474	.400	.342	.450	.381	.328	.402	.346	.301	.359	.312	.274	.318	.280	.248	.223
	5	.415	.341	.284	.394	.325	.272	.354	.295	.251	.316	.266	.229	.280	.240	.207	.184
	6	.372	.297	.245	.352	.284	.233	.316	.258	.215	.283	.234	.197	.252	.210	.178	.157
	7	.334	.262	.213	.317	.249	.203	.285	.227	.187	.255	.207	.170	.228	.187	.155	.136
	8	.300	.231	.182	.285	.221	.175	.256	.202	.162	.231	.183	.148	.206	.165	.135	.117
	9	.271	.204	.157	.258	.195	.152	.233	.178	.140	.209	.162	.128	.187	.146	.117	.100
	10	.246	.181	.139	.234	.175	.135	.212	.160	.124	.191	.145	.113	.172	.132	.102	.087

Effective Floor Cavity Reflectance (Rfc) is 20%

A-51 Incandescent Fixture with Standard Dome Reflector
 Spacing to Mtg. Ht.
 Ratio 1.25:1
 Guard .890

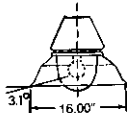
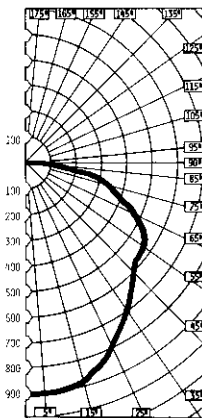

% Ceiling Rcc	Effective Floor Cavity Reflectance (Rfc) is 20%																
	80		70		50		30		10		0						
% Walls	Rw	50	30	10	50	30	10	50	30	10	50	30	10	0			
ROOM CAVITY RATIOS	1	.757	.727	.700	.740	.713	.689	.709	.686	.667	.681	.663	.646	.656	.641	.627	.612
	2	.660	.613	.572	.647	.603	.567	.621	.585	.552	.598	.568	.540	.577	.551	.528	.512
	3	.580	.524	.478	.570	.516	.475	.549	.504	.466	.529	.490	.458	.511	.478	.449	.434
	4	.514	.452	.403	.504	.446	.400	.486	.436	.395	.469	.425	.390	.454	.415	.384	.368
	5	.451	.385	.336	.442	.380	.334	.427	.372	.332	.413	.364	.327	.399	.357	.323	.308
	6	.402	.336	.291	.394	.333	.286	.381	.326	.285	.369	.319	.282	.358	.313	.279	.264
	7	.361	.296	.254	.355	.293	.250	.343	.286	.247	.332	.282	.245	.323	.278	.243	.229
	8	.323	.261	.216	.318	.258	.216	.308	.254	.215	.299	.249	.213	.290	.245	.211	.197
	9	.291	.230	.187	.287	.227	.187	.278	.223	.186	.269	.219	.184	.262	.216	.182	.169
	10	.264	.204	.166	.259	.204	.166	.253	.200	.164	.245	.197	.162	.240	.194	.161	.149

A-51™ Incandescent Factory Sealed Luminaires

For Group C and D Locations. Explosionproof

Photometric data shown here is based on a 200-watt type PS-30 lamp and is representative of the performance for all A-51 incandescent fixtures using 60-watt to 300-watt lamps. For candlepower values of fixtures with other lamps, use the following multipliers: 60 W A-19 - 0.23; 100 W A-19 - 0.47; 150 W A-21 - 0.75; 200 W A-23 - 1.07; 200 W A-25 - 1.02; 200 W PS-25 - 1.03; 300 W PS-25 - 1.70; 300 W PS-30 - 1.63. To determine candlepower values of fixtures with a guard, multiply by value shown with each curve.

NEC/CEC — For Group C and D:
Class I, Division 1 and 2, Groups C, D
Class II, Division 1 and 2, Groups E, F, G
Class III

Photometric Data

Effective Floor Cavity Reflectance (Rfc) is 20%

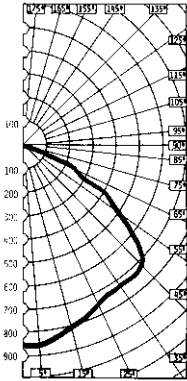

A-51 Incandescent Fixture with High Bay Reflector

Spacing to Mtg.
 Ht. Ratio 1.40:1
 Guard .865

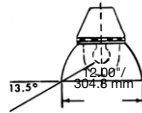

% Ceiling Rcc	Effective Floor Cavity Reflectance (Rfc) is 20%																
	80		70			50			30			10			0		
% Walls	Rw	50	30	10	50	30	10	50	30	10	50	30	10	50	30	10	0
ROOM CAVITY RATIOS	1	.686	.644	.645	.671	.651	.634	.644	.628	.614	.620	.607	.595	.598	.588	.577	.566
	2	.614	.580	.549	.603	.571	.545	.581	.555	.531	.562	.540	.520	.544	.525	.508	.496
	3	.550	.508	.473	.542	.501	.470	.524	.490	.461	.507	.478	.454	.492	.467	.446	.434
	4	.493	.445	.408	.486	.441	.404	.470	.431	.400	.456	.422	.395	.443	.413	.389	.377
	5	.439	.387	.349	.432	.383	.347	.420	.376	.344	.407	.369	.340	.396	.383	.336	.324
	6	.393	.340	.304	.387	.338	.300	.376	.331	.298	.366	.326	.296	.356	.320	.293	.281
	7	.352	.299	.264	.347	.296	.261	.337	.290	.258	.327	.287	.256	.320	.283	.254	.242
	8	.313	.261	.224	.309	.259	.223	.300	.255	.222	.293	.251	.220	.285	.247	.219	.207
	9	.280	.228	.191	.276	.225	.191	.268	.222	.190	.261	.219	.189	.254	.216	.187	.176
	10	.252	.201	.168	.248	.201	.168	.242	.197	.167	.236	.195	.165	.231	.192	.164	.153

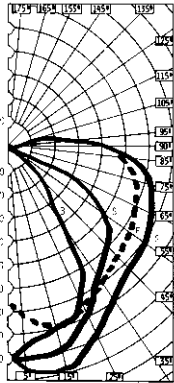

A-51 Incandescent Fixture with 30° Reflector



B—
 Back
 S—Side
 F—Front
 G—Front W.Guard



INCANDESCENT/AREA: NEC/CEC EXPLOSIONPROOF







A-51™ Incandescent Factory Sealed Luminaires

For Group A and B Locations. Explosionproof

Suitable for use in Wet Locations. UNILETS® for use with Threaded Metal Conduit.

NEC/CEC:

Class I, Division 1 and 2, Groups A♦, B, C, D
 Class II, Division 1 and 2, Groups E, F, G
 Class III

		Hub Size (Inches)	Catalog Number ①②
Pendant ♦ — One Hub, Rigid or Flexible Mounting			
	60-200 W (AAUA-15)	1/2	AAPA1550
	PS-25	3/4	AAPA1575
	200-300 W (AAUA-2)	1/2	AAPA2050
	PS-30	3/4	AAPA2075
Ceiling — Four Hubs, Three Close-up Plugs			
	60-200 W (AAUA-15)	1/2	AACA1550
	PS-25	3/4	AACA1575
	200-300 W (AAUA-2)	1/2	AACA2050
	PS-30	3/4	AACA2075
15° Short Bracket — Two Hubs, One Close-up Plug			
	60-200 W (AAUA-15)	1/2	AASBA1550
	PS-25	3/4	AASBA1575
	200-300 W (AAUA-2)	1/2	AASBA2050
	PS-30	3/4	AASBA2075
Reflectors			
Porcelain	Polyester	Standard Dome	
			
406.4 (16.00)	406.4 (16.00)	60-200 W (AAUA-15)	Porcelain AARW-15ST
		200-300 W (AAUA-2)	Polyester AARP-2ST
		30° Angle	
304.8 (12.00)	304.8 (12.00)	60-200 W (AAUA-15)	AARW-15AN
		200-300 W (AAUA-2)	AARW-2AN AARP-2AN

① See A-51™ Incandescent Factory Sealed Luminaire Classified Area Suitability page for suitability of specific fixtures.

② Add suffix -G to catalog number for optional guard.

♦ Shaded area indicates pendant mount is suitable for Class I, Group A in addition to other applicable area suitabilities.









A-51™ Incandescent Factory Sealed Luminaires

For Group A and B Locations. Explosionproof

Suitable for use in Wet Locations. UNILETS® for use with Threaded Metal Conduit.

NEC/CEC — For Group A and B:
 Class I, Division 1 and 2, Groups A, B, C, D
 Class II, Division 1 and 2, Groups E, F, G
 Class III

Mounting Hoods

	Type	Hub Size (Inches)	Catalog Number
Pendant		One Hub, Rigid or Flexible Mounting	1/2 AAP-50 ① 3/4 AAP-75 ①
		Ceiling	
15° Short Bracket			
			Description
Fixture Units		60-200 W PS-25	AAUA-15
		200-300 W PS-30	AAUA-2
Globe and Ring Assembly		60-200 W (AAUA-15)	AAGLA-15
		200-300 W (AAUA-2)	AAGLA-2
Aluminum Guards		60-200 W (AAUA-15)	AAGUA-15
		200-300 W (AAUA-2)	AAGU-2
Medium Base Lamp Socket		60-200 W (AAUA-15)	AASPA-15
		200-300 W (AAUA-2)	AASPA-22
Connection Block		Fits all A-51 and AA-51 mounting hoods 60-300 W	VPT-7

① Group A pendant mount only.

A-51™ Incandescent Factory Sealed Luminaires

For Group A and B Locations. Explosionproof

Suitable for use in Wet Locations. UNILETS® for use with Threaded Metal Conduit.

NEC/CEC — For Group A and B:
 Class I, Division 1 and 2, Groups A, B, C, D
 Class II, Division 1 and 2, Groups E, F, G
 Class III

Dimensions in Millimeters (Inches)

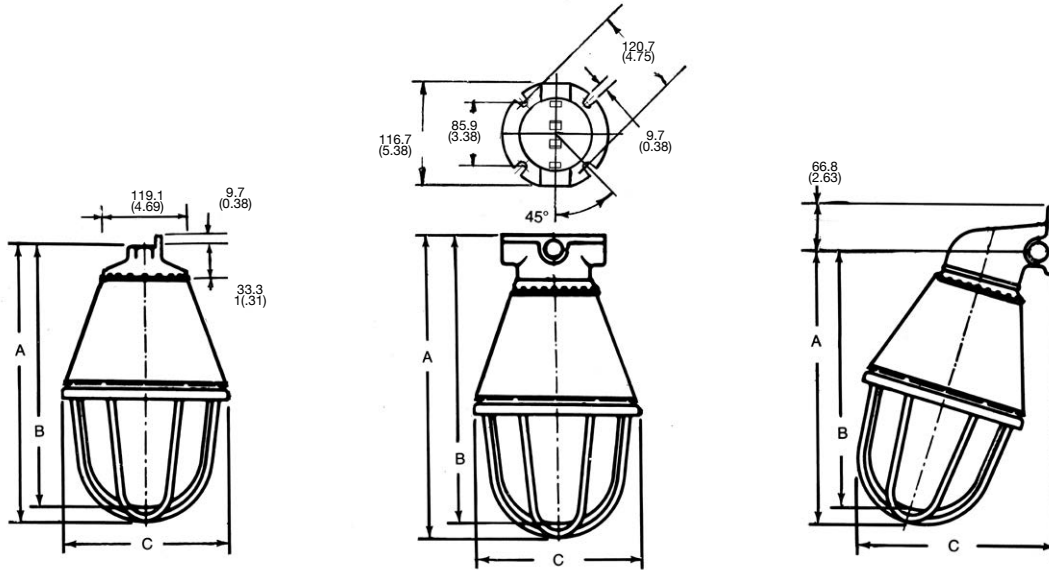

Size (Watts)	Pendant			Ceiling			Short Bracket		
	A	B	C	A	B	C	A	B	C
60-200	347.7 (13.69)	333.5 (13.13)	179.3 (7.06)	419.1 (16.50)	404.9 (15.94)	179.3 (7.06)	381.0 (15.00)	366.8 (14.44)	241.3 (9.50)
200-300	374.7 (14.75)	347.7 (13.69)	223.8 (8.81)	446.0 (17.56)	419.1 (16.50)	223.8 (8.81)	406.4 (16.00)	392.2 (15.44)	263.7 (10.38)

Appleton

INCANDESCENT/AREA: NEC/CEC EXPLOSIONPROOF

A-51™ Incandescent Factory Sealed Luminaires

For Group A and B Locations. Explosionproof

Photometric data shown here is based on a 200 watt type PS-25 lamp, and is representative of the performance for A-51 incandescent fixtures (Groups A and B). For candlepower values of fixtures with other lamps, use the following multipliers: 150 W (PS-25) – 0.70; and 300 W (PS-25) – 1.6. To determine candlepower values of fixtures with a guard, multiply by value shown with each curve.

NEC/CEC — For Group A and B:
 Class I, Division 1 and 2, Groups A, B, C, D
 Class II, Division 1 and 2, Groups E, F, G
 Class III

Photometric Data

Effective Floor Cavity Reflectance (Rfc) is 20% (No Reflector)

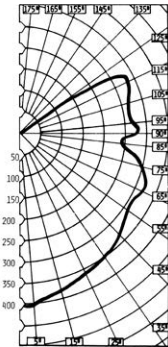

A-51 Incandescent Fixture without Reflector

Spacing to Mtg.
 Ht. Ratio 1.34:1
 Guard .80



% Ceiling Rcc	Effective Floor Cavity Reflectance (Rfc) is 20% (No Reflector)																
	80		70		50		30		10		0						
% Walls	Rw	50	30	10	50	30	10	50	30	10	0						
ROOM CAVITY RATIOS	1	.711	.669	.630	.669	.631	.595	.590	.560	.533	.518	.495	.473	.452	.434	.417	.383
	2	.602	.541	.488	.567	.511	.465	.499	.455	.416	.437	.402	.371	.380	.352	.327	.296
	3	.519	.449	.393	.488	.424	.374	.430	.379	.336	.375	.335	.300	.325	.292	.264	.236
	4	.456	.384	.328	.430	.364	.312	.379	.325	.282	.332	.288	.252	.288	.252	.223	.197
	5	.400	.328	.274	.378	.311	.260	.334	.278	.236	.293	.247	.211	.254	.217	.187	.164
	6	.357	.285	.234	.336	.270	.221	.297	.242	.200	.261	.215	.180	.227	.188	.159	.138
	7	.318	.248	.200	.300	.234	.190	.265	.209	.171	.233	.187	.153	.204	.165	.135	.116
	8	.287	.219	.172	.270	.208	.164	.240	.187	.149	.212	.167	.134	.194	.147	.119	.101
	9	.260	.194	.150	.246	.185	.143	.218	.166	.130	.192	.148	.117	.168	.131	.103	.087
	10	.236	.173	.132	.222	.166	.126	.199	.149	.114	.175	.133	.102	.154	.117	.090	.075

Effective Floor Cavity Reflectance (Rfc) is 20% (No Reflector)

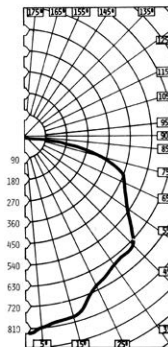

A-51 Incandescent Fixture with Standard Dome Reflector

Spacing to Mtg.
 Ht. Ratio 1.2:1
 Guard .80

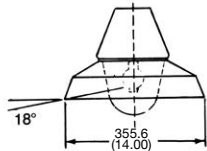

% Ceiling Rcc	Effective Floor Cavity Reflectance (Rfc) is 20% (No Reflector)																
	80		70		50		30		10		0						
% Walls	Rw	50	30	10	50	30	10	50	30	10	0						
ROOM CAVITY RATIOS	1	.797	.763	.733	.779	.748	.721	.745	.720	.697	.715	.695	.676	.689	.671	.655	.640
	2	.687	.633	.586	.673	.622	.581	.645	.603	.566	.620	.585	.553	.597	.567	.541	.524
	3	.594	.530	.478	.583	.522	.474	.560	.508	.464	.538	.494	.457	.519	.481	.448	.431
	4	.527	.458	.404	.517	.452	.400	.497	.440	.395	.479	.430	.390	.462	.419	.384	.366
	5	.466	.393	.340	.456	.388	.337	.440	.379	.335	.424	.371	.330	.410	.364	.326	.310
	6	.414	.342	.292	.406	.339	.288	.391	.331	.286	.378	.324	.283	.367	.317	.280	.264
	7	.369	.298	.252	.362	.294	.248	.350	.288	.245	.337	.284	.242	.328	.279	.240	.225
	8	.333	.265	.217	.327	.262	.216	.316	.257	.215	.307	.252	.213	.297	.248	.211	.196
	9	.302	.235	.189	.297	.232	.189	.287	.229	.188	.278	.224	.186	.270	.221	.185	.170
	10	.273	.209	.167	.268	.209	.167	.261	.204	.166	.253	.201	.163	.247	.198	.162	.149

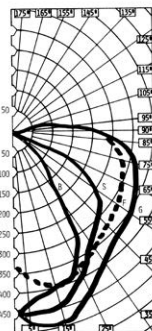

A-51 Incandescent Fixture with 30° Angle Reflector

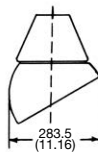

B—Back
 S—Side
 F—Front
 G—Front W/Guard



EDT Incandescent Luminaires

Dust-Ignitionproof

Suitable for use in Wet Locations.

NEC/CEC:

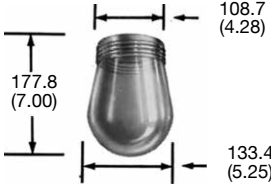
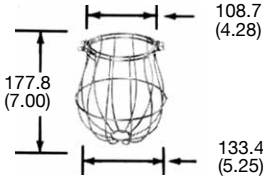
Class II, Division 1 and 2, Groups E, F, G
Class III

Description	Watts	Hub Size (Inches)	Catalog Number
Pendant Lighting Fixture mm (in) ^① 	60-200 W	1/2	EDTP2050
Heat-Resistant Clear Glass Globe 	60-200 W		VSGL-2HR
Globe Guard 	60-200 W		DPGU-2
Replacement Porcelain Shock-Absorbing Socket – Medium Base 	60-200 W		VPLR-123

^① T3C maximum operating temperature. Supply wire +150 °C (+302 °F). Maximum ambient temperature +25 °C (+77 °F). Vertical mount only (globe down).

ATX™ HBE Series Round Bulkhead Luminaires

Increased Safety. Incandescent

ATEX:
Zone 1 and 2 - 21 and 22
Ⓜ II 2 GD
IP65

Applications

- Suitable for use in:
 - Stairways
 - Small areas
 - Emergency exit

Features

- For incandescent lamps 60 W to 150 W maximum, mixed lamp 100 W maximum. Lamps not supplied.
- E27 lampholder.
- Screw locking mechanism.
- Operates in all positions.
- Connection to lampholder via two 2 x 2.5 mm² (0.003 x 0.004 in²) terminals.
- Internal earth two terminals 2 x 2.5 mm² (0.003 x 0.004 in²). External earth 1 x 4 mm² (0.002 x 0.006 in²).
- Three M20 entries in “T” formation. Supplied with one M20 cable gland [6.5 to 14.5 mm (0.26 to 0.57 in) diameter] and two M20 blanking plugs.

Standard Materials

- Body: gray painted aluminum alloy
- Diffuser: glass
- Sealing gasket: silicone
- Guard: zinc plated steel
- Cable gland and blanking plug: polyamide

ATEX Certifications and Compliances

- Certification Type: HBe150
 - Gas: Zones 1 and 2
 - Conforming to ATEX 94/9/CE: Ⓜ II 2 G
 - Type of Protection: Ex e II
 - Temperature Class: See *T Rating (Gas) and Surface Temperature (Dust) Table*
 - Dust: Zones 21 and 22
 - Conforming to ATEX 94/9/CE: Ⓜ II 2 D
 - Type of Protection: Ex tD A21
 - Surface Temperature: T102 °C to T137 °C (T216 °F to T279 °F)
- Ambient Temperature: -40 °C to +50 °C (-40 °F to +122 °F)
- CE Declaration of Conformity: 50244
- ATEX Certificate: LCIE 02 ATEX 6228X
- Index of Protection according EN/IEC 60529: IP65

EURASEC Certification

- EURASEC N° TC RU C-FR.Г505.B.00912

Other Certification

- INMETRO Certificate: BVC 11.0494-X ①

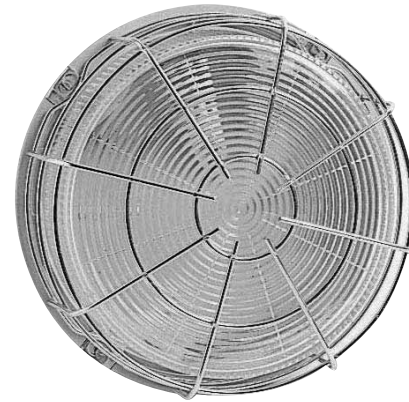

HBERI15 and HBEPGZ

INCANDESCENT/AREA: ATEX INCREASED SAFETY

Appleton®

① Inmetro certification available on special request only. Contact your local sales representative for more information.

ATX™ HBE Series Round Bulkhead Luminaires

Increased Safety. Incandescent











ATEX:
Zone 1 and 2 - 21 and 22
II 2 GD
IP65

	Weight kg (lb)	Volume dm ³ (in ³)	Catalog Number
	3 (6.61)	15 (915.36)	HBERI15

Accessories

	Catalog Number
Protective Guard	HBEPGZ
Spare Lamp Glass	HBEGD

T Rating (Gas) and Surface Temperature (Dust) Table

Lamp Type and Wattage			Gas				Dust
Wattage	Type	Operating Positions	For Ta = +40° C (+104° F)		+50° C (+122° F)		Surface T° for Ta = +50° C (+122° F)
			T Rating	T° at Cable Entry	T Rating	T° at Cable Entry	
60	Incandescent	Any Position	T2	⓪	T2	⓪	+102 °C (+216°F)
			T3	⓪	T3	⓪	
			T4	⓪	T4	⓪	
75	Incandescent	Any Position	T2	⓪	T2	⓪	+107 °C (+225°F)
			T3	⓪	T3	⓪	
			T4	⓪	T4	⓪	
100	Mercury	Any Position	T2	⓪	T2	+83 °C (+181°F)	+117 °C (+243°F)
			T3	⓪	T3	+83 °C (+181°F)	
			T3	⓪	T3	⓪	
100	Incandescent	Any Position	T1	+90 °C (+194 °F)	T1	+100 °C (+212 °F)	+137 °C (+279°F)
			T3	+90 °C (+194 °F)	T2	+100 °C (+212 °F)	
			T3	⓪	T3	⓪	
150	Mixed	Any Position	T2	+82 °C (+ 180°F)	T2	+92 °C (198 °F)	+130 °C (+266°F)
			T3	+82 °C (+ 180°F)	T3	+92 °C (198 °F)	
			T3	⓪	T3	⓪	

⓪ Not Applicable, no need for high temperature cable for cable entry temperature less than +80 °C (+176 °F).

ATX™ HBE Series Round Bulkhead Luminaires

Increased Safety. Incandescent

ATEX:
 Zone 1 and 2 - 21 and 22
 II 2 GD
 IP65

Dimensions in Millimeters (Inches)

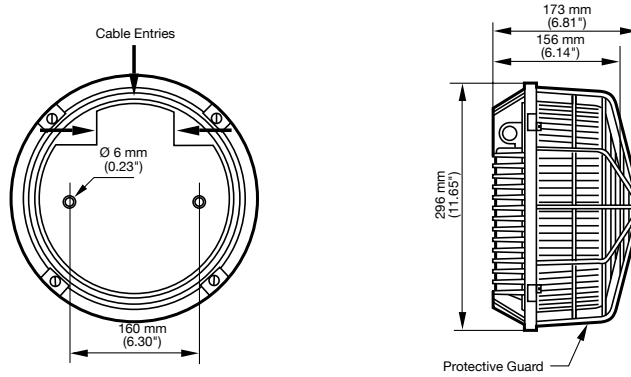

Photometric Data ①

150 W Incandescent
 NF C 71-120: .062 J + 0.10 T

CANDELA DISTRIBUTION

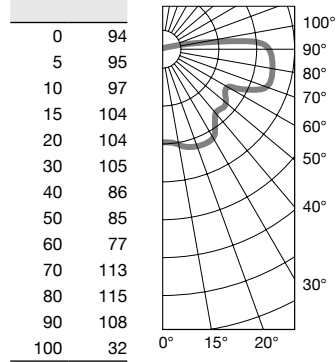

① Polar curves for a 1000 lm flux, according to NF C 71-120. Luminaire symbol according to NF C 71-121.

ATX™ ELS Series Self-Contained Emergency Lighting Unit

Incandescent

ATEX:
Zone 2 and 22
II 3 GD
IP66

Applications

- Enclosed and gasketed, non-metallic emergency lighting system suitable for use where flammable gases, vapors or dusts may become present due to abnormal conditions defined as Zone 2 and 22.
- Typical applications include manufacturing plants, refineries, petrochemical and chemical plants, waste and sewage treatment facilities, food processing facilities and other industrial manufacturing or process facilities subject to wet or corrosive conditions.

Features

- Provides 90 minutes of emergency lighting.
- The electronics consists of a solid state charger, transfer circuit and low voltage disconnect circuit.
- A LED pilot light indicates the presence of AC line voltage, and a test switch is provided for testing transfer operation.
- Upon restoration of normal power, the charger will begin a recharge cycle. It will bring the battery to full capacity.
- 6 A fuse provided as standard.
- 12 Vdc, 10 W or 21 W incandescent lamps.
- ATEX/IEC lamp base BA15D.
- Battery capacity 7 A/h.
- Connections on 2.5 mm² (0.004 in²) terminals.

Standard Materials

- Fiberglass reinforced polyester housing, carbon loaded for low resistivity
- Aluminium glass sealed spotlight

ATEX Certifications and Compliances

- Certification Type: ELS
 - Gas: Zone 2
 - Conforming to ATEX 94/9/CE: II 3 G
 - Type of Protection: Ex nAR II
 - Temperature Class: T2
 - Dust: Zone 22
 - Conforming to ATEX 94/9/CE: II 3 D
 - Type of Protection: Ex tD A22
 - Surface Temperature: +121 °C (+250 °F)
- Ambient Temperature: -20 °C to +55 °C (-4 °F to +131 °F)
- CE Declaration of Conformity: 50282
- ATEX Certificate: LCIE 02 ATEX 6046
- Index of Protection according EN/IEC 60529: IP66
- Impact Resistance (shock): IK10 (housing)

Other Certification

- INMETRO Certificate: BVC11.0643-X ①



2 Lamp Version — ELS 2100712A

INCANDESCENT/AREA: ATEX EMERGENCY

Appleton®

① Inmetro certification available on special request only. Contact your local sales representative for more information.

ATX™ ELS Series Self-Contained Emergency Lighting Unit

Incandescent

ATEX:
 Zone 2 and 22
 II 3 GD
 IP66

2 x M20 entries at the top, supplied with one M20 polyamide cable gland [cable diameter 6.5 to 14.5 mm (0.26 x 0.57 in)] and one M20 blanking plug.

Number of Lamps	Wattage (W)	Weight kg (lb)	Volume dm ³ (in ³)	Catalog Number	
				205–254 Vac, 50/60 Hz	110 – 120 Vac, 50/60 Hz
1	10	8.50 (18.74)	4.55 (277.7)	ELS1100712A	ELS1100712B
2	10	7.70 (16.98)	4.80 (292.9)	ELS2100712A	ELS2100712B
1	21	8.50 (18.74)	4.55 (277.7)	ELS1210712A	ELS1210712B
2	21	7.70 (16.98)	4.80 (292.9)	ELS2210712A	ELS2210712B

Dimensions in Millimeters (Inches)

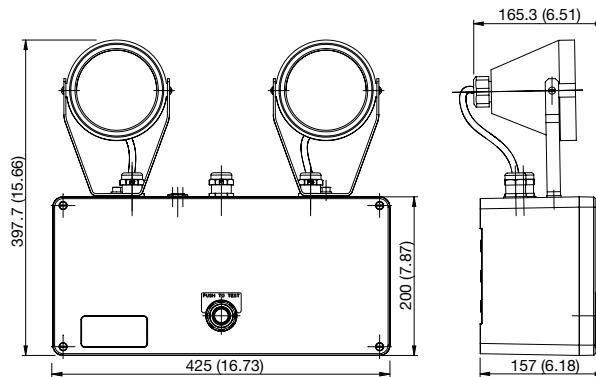

INCANDESCENT/AREA: ATEX EMERGENCY SAFETY

Appleton

ATX™ HBD Series Bulkhead Luminaires

Flameproof. Incandescent, Compact Fluorescent, Mixed

ATEX:
Zone 1 and 2 – 21 and 22
Ⓢ II 2 GD
IP66 - IK08

Applications

- Suitable for use in:
 - Stairways
 - Small areas
 - Emergency exit

Features

- HBDR
 - Lamps (not supplied)
 - Incandescent 200 W maximum
 - Compact Fluorescent 23 W maximum
 - Mixed 160 W maximum
 - Threaded flameproof joint.
 - Operates on ceiling and wall.
- HBDO
 - Incandescent 60 W to 100 W maximum
 - Compact fluorescent 15 W maximum
 - Operates in any position.
 - For incandescent 60 W and 100 W a high temperature cable 106 °C (223 °F) is required.
- Lamps are not supplied.
- E27 lampholder.
- Fixing by two integrated brackets.
- Connection to lampholder via two terminals 2.5 mm² (0.004 in²).
- Internal earth two terminals 2.5 mm² (0.004 in²).
- External earth one 4 mm² (0.006 in²).
- 3 x M20 threaded entries in “T” formation.
- Supplied with two blanking plugs M20.

Standard Materials

- Body and bezel: gray painted aluminum
- Glass: sealed toughened lamp glass
- Protective guard: zinc plated steel

ATEX Certifications and Compliances

- HBRD
 - Certification Type: HBRd
 - Gas: Zones 1 and 2
 - Conforming to ATEX 94/9/CE: Ⓢ II 2 G
 - ATEX/IEC Protection: Ex d IIC
 - T Rating: See *T Rating for Gas Table*
 - Dust: Zones 21 and 22
 - Conforming to ATEX 94/9/CE: Ⓢ II 2 D
 - ATEX/IEC Protection: Ex tD A21
 - Ambient Temperature: -40 °C to +55 °C (-40 °F to +131 °F)
 - CE Declaration of Conformity: 50242
 - ATEX Certificate: LCIE 02 ATEX 6163
- HBDO
 - Certification Type: HBOD
 - Gas: Zones 1 and 2
 - Conforming to ATEX 94/9/CE: Ⓢ II 2 G
 - Type of Protection: Ex d IIB
 - Temperature Class: See *T Rating for Gas Table*
 - Dust: Zones 21 and 22
 - Conforming to ATEX 94/9/CE: Ⓢ II 2 D
 - Type of Protection: Ex tD A21
 - Ambient Temperature: -20 °C to +40 °C (-4 °F to +104 °F)
 - CE Declaration of Conformity: 50234
 - ATEX Certificate: LCIE 02 ATEX 6162



HBDR
Round Bulkhead



HBDO
Oval Bulkhead

- Index of Protection according EN/IEC 60529: IP66
- Impact Resistance (shock): IK08
- Internal Volume: > 2 dm³ (122 in³) - 2 liters

EURASEC Certification

- EURASEC N° TC RU C-FR.Г505.B.00912

Other Certification

- HBDO
 - Certification Type: HBOD
 - INMETRO Certificate: BVC11.0597 ①

① Inmetro certification available on special request only. Contact your local sales representative for more information.

ATX™ HBD Series Bulkhead Luminaires

Flameproof. Incandescent, Compact Fluorescent, Mixed

ATEX:
 Zone 1 and 2 – 21 and 22
 II 2 GD
 IP66 - IK08

HBDR Series Bulkhead Luminaires – Incandescent, Compact Fluorescent, Mixed

Dimensions in Millimeters (Inches)

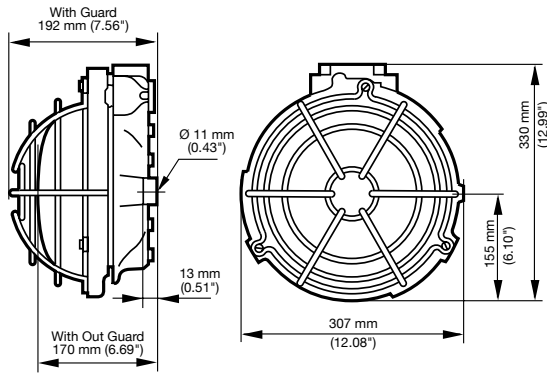

Photometric Data ①

Incandescent
 NF C 71-120: .068 G + 0.01 T

CANDELA DISTRIBUTION

0	185
5	178
10	171
15	156
20	132
25	110
30	97
35	87
40	90
45	100
50	96
60	58
70	58

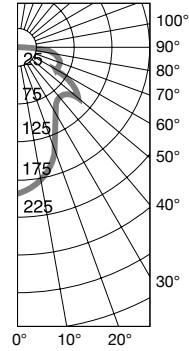

HBDO Series Bulkhead Luminaires – Incandescent, Compact Fluorescent

Dimensions in Millimeters (Inches)

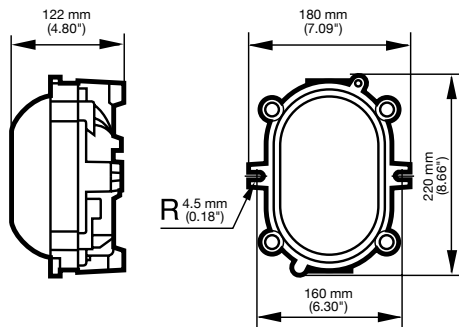

Photometric Data ①

Incandescent
 NF C 71-120: .068 H

CANDELA DISTRIBUTION

0	67
5	94
10	96
15	99
20	99
25	97
30	95
35	96
40	91
45	91
50	98
60	87
70	69

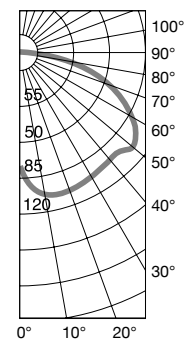

① Polar curves for a 1000 lm output according to NF C 71-120. Luminaire symbol according to NF C 71-121.

ATX™ HBDR Series Bulkhead Luminaires

Flameproof. Incandescent, Compact Fluorescent, Mixed

ATEX:
Zone 1 and 2 – 21 and 22
II 2 GD
IP66 - IK08

Appleton®

INCANDESCENT/AREA: ATEX/IECx FLAMEPROOF

	Weight kg (lb)	Volume dm ³ (in ³)	Catalog Number
	7.5 (16.53)	23.4 (51.59)	HBDR

Accessories	Catalog Number
Protective Guard	HBDRPGZ

T Rating for Gas ①

Lamp Type and Wattage		Ambient Temperature	Operating Positions					
			Ceiling		Wall			
Wattage	Type		+40° C (+104° F)	+50° C (122° F)	+55° C (+131° F)	+40° C (+104° F)	+50° C (122° F)	+55° C (+131° F)
8	Compact Fluorescent	T Rating	T6	T6	T6	T6	T6	T6
15	Compact Fluorescent	T Rating	T6	T6	T6	T6	T6	T6
23	Compact Fluorescent	T Rating	T6	T6	T6	T5	T5	T4
100	Incandescent	T Rating	T5	T4	T4	T5	T4	T4
200	Incandescent	T Rating	T4	T4	T4	T4	T4	T4
		T° at cable entry	—	+84° C (+183° F)	+89° C (+192° F)	—	+84° C (+183° F)	+89° C (+192° F)
100	Mixed	T Rating	T4	T4	T4	T4	T4	T4
180	Mixed	T Rating	T3	T3	T3	T3	T3	T3
		T° at cable entry	—	+87° C (+188° F)	+92° C (+198° F)	—	+87° C (+188° F)	+92° C (+198° F)

Surface Temperature for Dust ①

Lamp Type and Wattage		Operating Positions			
		Ceiling		Wall	
Wattage	Type	Surface T° for Ta = +55° C (+131° F)	T° at Cable Entry Ta = +55° C (+131° F)	Surface T° for Ta = +55° C (+131° F)	T° at Cable Entry Ta = +55° C (+131° F)
8	Compact Fluorescent	+60° C (+140° F)	—	+70° C (+158° F)	—
15	Compact Fluorescent	+64° C (+147° F)	—	+76° C (+169° F)	—
23	Compact Fluorescent	+69° C (+156° F)	—	+96° C (+205° F)	—
100	Incandescent	+105° C (+221° F)	—	+105° C (+221° F)	—
200	Incandescent	+130° C (+266° F)	+89° C (+192° F)	+130° C (+266° F)	+89° C (+192° F)
100	Mixed	+130° C (+266° F)	—	+130° C (+266° F)	—
160	Mixed	+149° C (+300° F)	+92° C (+198° F)	+149° C (+300° F)	+92° C (+198° F)

① No need for high temperature cable for cable entry temperature less than +80° C (+176° F).

ATX™ HBDO Series Bulkhead Luminaires

Flameproof. Incandescent, Compact Fluorescent

ATEX:
 Zone 1 and 2 – 21 and 22
 II 2 GD
 IP66 - IK08

	Weight kg (lb)	Volume dm ³ (in ³)	Catalog Number
	3 (6.61)	9 (19.84)	HBDO

Accessories

	Catalog Number
Protective Guard	HBDOPGZ
Terminal block For through wiring 2 x 2.5 mm ² (0.003 x 0.004 in ²) with high temperature sleeve	094784

T Rating for Gas ①

Lamp Type and Wattage			
Wattage	Type	Temperature Class for Ta = +40 °C (+104 °F)	T° at Cable Input for Ta = +40 °C (+104 °F)
7	Compact Fluorescent	T6	—
11	Compact Fluorescent	T6	—
15	Compact Fluorescent	T6	—
60	Incandescent	T4	+106 °C (+223 °F)
100	Incandescent	T4	+106 °C (+223 °F)

T Rating for Dust ①

Lamp Type and Wattage		
Wattage	Type	Temperature Class for Ta = +40 °C (+104 °F)
7	Compact Fluorescent	+76 °C (+169 °F)
11	Compact Fluorescent	+76 °C (+169 °F)
15	Compact Fluorescent	+76 °C (+169 °F)
60	Incandescent	+119 °C (+246 °F)
100	Incandescent	+119 °C (+246 °F)

① No need for high temperature cable for cable entry temperature less than +80 °C (+176 °F).

ATX™ HBN Series Round Bulkhead Luminaires

Flameproof. Incandescent

ATEX:
Zone 2 and 22
II 3 GD
IP65

Applications

- Suitable for use in:
 - Stairways
 - Small areas
 - Emergency exit

Features

- For incandescent lamps 60 W to 150 W maximum, mixed lamp 100 W maximum, mercury 80 W maximum (remote mercury ballast not supplied). Lamps not supplied.
- E27 lampholder.
- Screw locking mechanism.
- Operates in all positions.
- Connection to lampholder via two 2 x 2.5 mm² (0.003 x 0.004 in²) terminals.
- Internal earth two terminals 2 x 2.5 mm² (0.003 x 0.004 in²). External earth 1 x 4 mm² (0.002 x 0.006 in²).
- Three M20 entries in “T” formation. Supplied with one M20 cable gland [6.5 to 14.5 mm (0.26 to 0.57 in) diameter] and two M20 blanking plugs.

Standard Materials

- Body: gray painted aluminum alloy
- Diffuser: glass
- Sealing gasket: silicone
- Guard: zinc plated steel
- Cable gland and blanking plug: polyamide

ATEX Certifications and Compliances

- Certification Type: HBN150
 - Gas: Zone 2
 - Conforming to ATEX 94/9/CE: II 3 G
 - Type of Protection: Ex nR II
 - Temperature Class: See *T Rating (Gas) and Surface Temperature (Dust) Table*
 - Dust: Zone 22
 - Conforming to ATEX 94/9/CE: II 3 D
 - Type of Protection: Ex tD A22
 - Surface Temperature: See *T Rating (Gas) and Surface Temperature (Dust) Table*
- Ambient Temperature: -20 °C ≤ Ta ≤ +50 °C (-4 °F ≤ Ta ≤ +122 °F); 80 W Mercury: -20 °C ≤ Ta ≤ +40 °C (-4 °F ≤ Ta ≤ 104 °F)
- CE Declaration of Conformity: 50220
- ATEX Certificate: LCIE 03 ATEX 6167X
- Index of Protection according EN/IEC 60529: IP65

EURASEC Certification

- EURASEC N° TC RU C-FR.Г505.B.00912

Other Certification

- INMETRO Certificate: BVC 11.0462-X ①

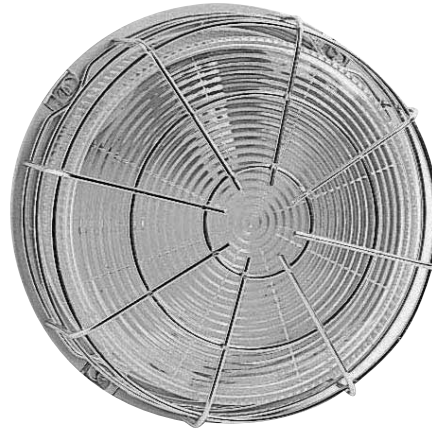

HBNRI15 and HBEPGZ

① Inmetro certification available on special request only. Contact your local sales representative for more information.

ATX™ HBN Series Round Bulkhead Luminaires

Flameproof. Incandescent

ATEX:
Zone 2 and 22
II 3 GD
IP65

	Weight kg (lb)	Volume dm ³ (in ³)	Catalog Number
	3 (6,61)	15 (33,07)	HBNRI15

Accessories

	Catalog Number
Protective Guard	HBEPGZ
Spare Lampglass	HBEGD

T Rating (Gas) and Surface Temperature (Dust) Table

Lamp Type and Wattage		Gas		Dust	
Wattage	Type	T Rating for Ta = +40 °C (+104 °F)	T Rating for Ta = +50 °C (+122 °F)	T° at Cable Input	Surface T° for Ta = +50 °C (+122 °F)
60	Incandescent	T5	T4	—	+101 °C (+214 °F)
75	Incandescent	T5	T4	—	+104 °C (+219 °F)
80	Mercury	T3	—	—	+131 °C (+268 °F) Ta = +40 °C (+104 °F)
100	Incandescent	T4	T4	+83 °C (+181 °F)	+114 °C (+237 °F)
100	Mixed	T4	T4	+100 °C (+212 °F)	+125 °C (+257 °F)
150	Incandescent	T4	T4	+92 °C (+198 °F)	+120 °C (+248 °F)

Dimensions in Millimeters (Inches)

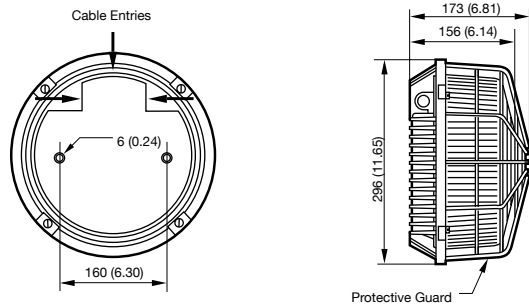

Photometric Data ①

Incandescent
NF C 71-120: .062 J + 0.10 T

CANDELA DISTRIBUTION

0	185
5	178
10	171
15	156
20	132
30	110
40	97
50	87
60	90
70	100
80	96
90	58
100	58

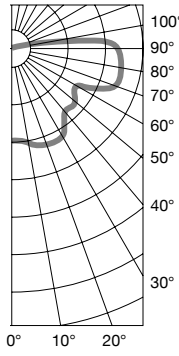

① Polar curves for a 1000 lm output according to NF C 71-120. Luminaire symbol according to NF C 71-121.

ATX™ HBDC Series Cylindrical Bulkhead Luminaires

Flameproof. Incandescent, Fluorescent, High Pressure Sodium

ATEX/IECEX:
Zone 1 and 2 - 21 and 22
Ⓢ II 2 GD
IP66/68 (10M) - IK08

Applications

- For illumination of:
 - Stairways
 - Small areas
 - Emergency exit

Features

- For lamps:
 - 70 W high pressure sodium (ovoid type E27 lampholder)
 - 18/20 W compact fluorescent lamp (E27 lampholder)
 - 2 x 40 W incandescent lamp (E27 lampholder)
 - 8 W fluorescent bulb (G5 lampholder) (lamp supplied)
- HPS version: compensated power supply (+/-10%) with power factor 0.9:
 - ATEX/IEC: 230/240 V, 50 Hz
- Connection to plug-in terminal block via 2 x 3 terminals 2.5 mm² (0.004 in²).
- Operates in any position.
- Threaded access cover with O-ring seal.
- Two integrated mounting lugs.
- 1 external earth via 4 mm² (0.006 in²) bracket.
- 2 threaded cable entries.
- Supplied with 1 plug M20 (cable gland not supplied).

Standard Materials

- End cap and cover: Zamak, anticorrosion treated and painted gray
- Sealed tube: toughened glass
- External reflector: galvanized steel painted white
- Protective guard: zinc plated steel
- Lamps are not supplied except for 8 W fluorescent bulb

Options

- Fixing accessories available in 316 stainless steel or zinc plated steel.
- Fall prevention fixing kit in stainless steel.

ATEX/IECEX Certifications and Compliances

- Certification Type: FLD
 - Gas: Zone 1 - 2
 - Conforming to ATEX 94/9/CE: Ⓢ II 2 G
 - Type of Protection: Ex d IIB/IIC
 - Temperature Class: See *T Rating (Gas) and Surface Temperature (Dust) Table*
 - Dust: Zone 21 - 22
 - Conforming to ATEX 94/9/CE: Ⓢ II 2 D
 - Type of Protection: Ex tD A21
 - Surface Temperature: See *T Rating (Gas) and Surface Temperature (Dust) Table*
- Ambient Temperature: -20 °C ≤ Ta ≤ +50 °C (-4 °F ≤ Ta ≤ +122 °F); for 70 W HPS: -40 °C ≤ Ta ≤ +50 °C (-40 °F ≤ Ta ≤ +122 °F)
- CE Declaration of Conformity: 50203
- ATEX Certificate: LCIE 97/ ATEX 6012
- IECEx Certificate: IECEx LCI 04.0018
- Index of Protection according EN/IEC 60529: IP66/68 (10 m)
- Impact Resistance (shock): IK08
- Internal Volume: > 2 dm³ (122 in³) - 2 liters



70 W High Pressure Sodium Version



Compact Fluorescent Version

EURASEC Certification

- EURASEC N° TC RU C-FR.Г505.B.00912

Other Certification

- INMETRO Certificate: BVC11.0492 ①

Related Products

- For labels see *Labels for Emergency Lighting Units, ATX Self-Adhesive Signaling Labels for Emergency Lighting Units.*

① Inmetro certification available on special request only. Contact your local sales representative for more information.

ATX™ HBDC Series Cylindrical Bulkhead Luminaires

Flameproof. Incandescent, Fluorescent, High Pressure Sodium

ATEX/IECEX:
 Zone 1 and 2 – 21 and 22
 Ⓢ II 2 GD
 IP66/68 (10M) - IK08

Order using catalog numbering guide below to decipher the catalog number logic on the following page.

Catalog Numbering Guide – HBDC Series Cylindrical Bulkhead Luminaires

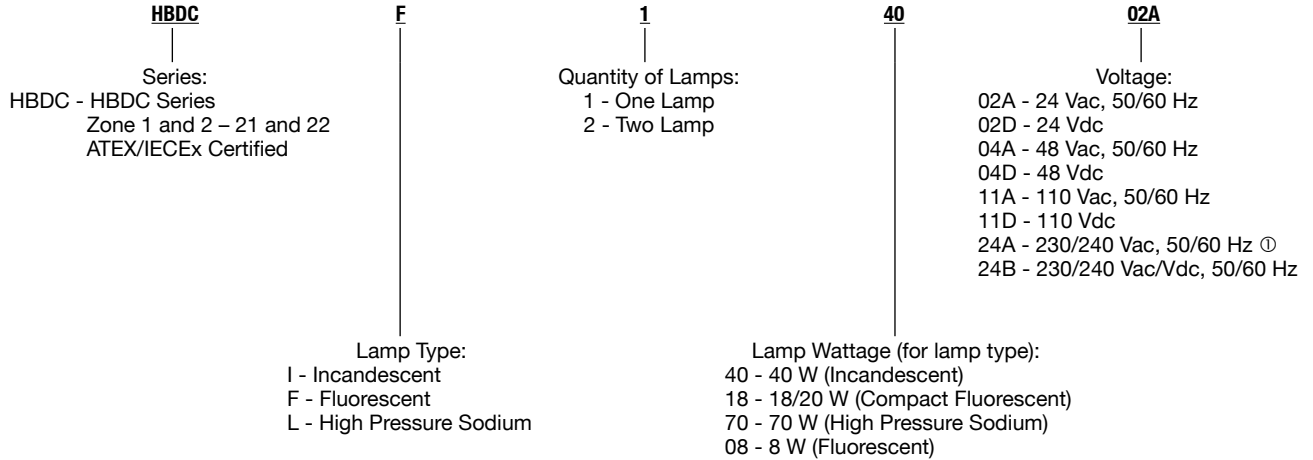

T Rating (Gas) and Surface Temperature (Dust) Table

Versions	Gas T Rating				Dust Surface Temperature	
	Without External Reflector		With External Reflector		Without External Reflector °C (°F)	With External Reflector °C (°F)
	Ta = +40 °C (+104 °F)	Ta = +55 °C (+131 °F)	Ta = +40 °C (+104 °F)	Ta = +55 °C (+131 °F)		
Incandescent lamp (2 x 40 W) ②	T5	T5	T5	T5	+95 (+203)	+95 (+203)
Compact Fluorescent lamp (20 W max)	T6	T5	T5	T4	+95 (+203)	+130 (+266)
Fluorescent (8 W - G5 lampholder)	T6	T5	T5	T4	+95 (+203)	+130 (+266)
High Pressure Sodium Lamp (70 W ovoid) ②	T4 for Ta = +50 °C (+122 °F)		–	–	+122 (+252)	–

① 50 Hz only for the 70 W HPS Version.

② Lamp not supplied.

ATX™ HBDC Series Cylindrical Bulkhead Luminaires

Flameproof. Incandescent, Fluorescent, High Pressure Sodium

ATEX/IECEX:
Zone 1 and 2 – 21 and 22
II 2 GD
IP66/68 (10M) - IK08

Lamp	Lampholder	Voltage	Weight kgs (lb)	Volume dm ³ (in ³)	Catalog Number
2x40 W Incandescent ①	E27	—	7.1 (16)	31 (1892)	HBDCI240
70 W High Pressure Sodium ①	E27	230/240 Vac, 50 Hz	7.1 (16)	33 (2014)	HBDCI17024A
		220 V, 60 Hz	—	—	—
1 x 8 W Fluorescent	G5	24 Vdc	8.3 (18)	31 (1892)	HBDCF10802D
1 x 8 W Fluorescent	G5	48 Vdc	8.3 (18)	31 (1892)	HBDCF10804D
1 x 8 W Fluorescent	G5	110 Vdc	8.3 (18)	31 (1892)	HBDCF10811D
1 x 8 W Fluorescent	G5	230/240 Vac, 50/60 Hz 198/254 Vdc	8.3 (18)	31 (1892)	HBDCF10824B
2 x 8 W Fluorescent	G5	230/240 Vac, 50/60 Hz 198/254 Vdc	8.3 (18)	31 (1892)	HBDCF20824B
1 x 18/20 W Compact Fluorescent ①	E27	—	7.1 (16)	33 (2014)	HBDCF118

	Description	Catalog Number
	External reflector in galvanized steel (painted white) (not compatible with 70 W HPS version)	FDER1G
	Protective guard in zinc plated steel	FDPG1Z
	Protective guard in zinc plated steel for 70 W HPS version	FDPG5Z
	Quick one-hand fixing (Set of 2 brackets) in zinc plated steel	FDFBZ
	Quick one-hand fixing (Set of 2 brackets) in 316 stainless steel	FDFBS
	Fixing unit on flat surface (Set of 2 brackets) in zinc plated steel	FDSBZ
	Fixing unit on flat surface (Set of 2 brackets) in 316 stainless steel	FDSBS
	Fixing unit in zinc plated steel for 1-1/2" tube [49 mm (1.93 in) diameter] or for 1-1/4" tube tube [42 mm (1.65 in) diameter]	FDHC49Z
	Fixing unit in 316 stainless steel for 1-1/2" tube [49 mm (1.93 in) diameter] or for 1-1/4" tube tube [42 mm (1.65 in) diameter]	FDHC49S
	Fixing unit in zinc plated steel for 2" tube [60 mm (2.36 in) diameter]	FDHC60Z
	Fixing unit in stainless steel for 2" tube [60 mm (2.36 in) diameter]	FDHC60S
	Fall prevention fixing kit in stainless steel [1.2 m (0.05 in) chain]	FDSCS

① Lamp not supplied.

ATX™ HBDC Series Cylindrical Bulkhead Luminaires

Flameproof. Incandescent, Fluorescent, High Pressure Sodium

ATEX/IECEX:
 Zone 1 and 2 - 21 and 22
 II 2 GD
 IP66/68 (10M) - IK08

Dimensions in Millimeters (Inches)

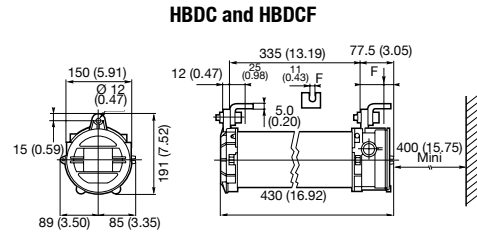
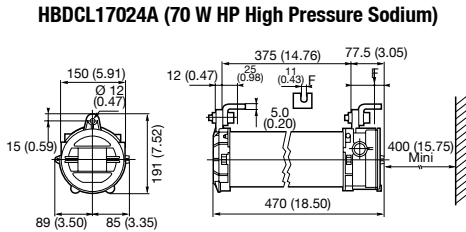

Photometric Data

Polar curves for a 1000 lm flux, according to NF C 71-120.
 Luminaire symbol according to NF C 71-121.

--- Longitudinal
 — Transverse

70 W HP High Pressure Sodium
 Efficiency 59.4%
 NF C 71-121: 0.56G + 0.04T

CANDELA DISTRIBUTION

	0-180	90-270
0	166	166
5	167	165
10	164	162
15	162	156
20	158	151
25	155	143
30	151	133
35	146	122
40	141	110
45	135	95
50	128	81
55	120	66
60	111	52
65	101	39
70	90	27

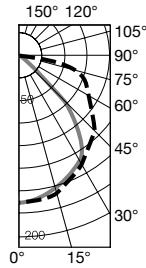

2x40 W Incandescent
 Efficiency: 75.6%
 NF C 71-121: 0.74G + 0.02T

CANDELA DISTRIBUTION

	0-180	90-270
0	196	196
5	197	198
10	196	196
15	193	194
20	189	190
25	181	185
30	176	179
35	170	172
40	163	164
45	155	153
50	145	128
60	123	91
70	99	43

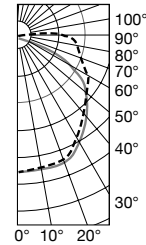

ATX™ LDP Series Wellglass Luminaires

Flameproof. Compact Fluorescent, Halogen, Incandescent, Mixed

ATEX:
Zone 1 and 2 – 21 and 22
II 2 GD
IP66 - IK08

Applications

- For use in hazardous locations such as plants where plastics, paints, thinners and petrochemicals are manufactured.
- Ideal for street lighting on refinery sites or oil depots and for tank lighting purposes.

Features

- Permissible lamps (not supplied):
 - 18 to 25 W compact fluorescent lamps
 - 70 to 150 W halogen lamps
 - Up to 200 W incandescent lamps
 - Up to 160 W mixed lamps
- E27 lamp holder.
- Threaded flame path.
- Connection to lampholder:
 - 2 x 2.5 mm² (0.0039 in²) or to terminal block
 - 2 x 2.5 mm² (0.0039 in²) supplied for through-wiring application.
- Suspension via integrated eye bolt for side cable entry versions.
- Supplied with one blanking plug for side cable entry versions.

Standard Materials

- Body and bezel: gray painted marine grade aluminum alloy
- Internal reflector: aluminum

ATEX Certifications and Compliances

- Certification Type: AB14
 - Gas: Zone 1 - 2
 - Conforming to ATEX 94/9/CE: II 2 G
 - Type of Protection: Ex d IIC
 - Temperature Class: See *T Rating for Gas Table*



Side Cable Entry Version

- Dust: Zone 21 - 22
- Conforming to ATEX 94/9/CE: II 2 D
- Type of Protection: Ex tD A21
- Surface Temperature: See *Surface Temperature for Dust Table*
- Ambient Temperature: -40 °C to +55 °C (-40 °F to +131 °F)
- CE Declaration of Conformity: 50231
- ATEX Certificate: LCIE 02 ATEX 6053
- Index of Protection according EN/IEC 60529: IP66
- Impact Resistance (shock): IK08
- Internal Volume: > 2 dm³ (122 in³) - 2 liters

EURASEC Certification

- EURASEC N° TC RU C-FR.Г505.B.00912

T Rating for Gas

Lamp Type and Wattage	T Rating	Ambient Temperature					
		Ta = +40 °C (+104 °F)				Ta = +50 °C (+122 °F)	
		Cable Entry Temperature		Cable Entry Temperature		Cable Entry Temperature	
		°C	°F	T Rating	°C	°F	
18 W Compact Fluorescent	T6	–	–	T5	–	–	
20 W Compact Fluorescent	T6	–	–	T5	–	–	
25 W Compact Fluorescent	T6	–	–	T5	–	–	
70 W Halogen	T4	–	–	T3	+90	+194	
150 W Halogen	T4	+85	+185	T3	+95	+203	
160 W Mixed	T4	+115	+239	T3	+125	+257	
100 W Incandescent	T4	+115	+239	T3	+125	+257	
200 W Incandescent	T4	+115	+239	T3	+125	+257	

Surface Temperature for Dust

Lamp Type and Wattage	Ambient Temperature — Ta = +50 °C (+122 °F)				
	Surface Temperature		Cable Entry Temperature		
	°C	°F	°C	°F	
18 W Compact Fluorescent	+85	+185	–	–	
20 W Compact Fluorescent	+85	+185	–	–	
25 W Compact Fluorescent	+85	+185	–	–	
70 W Halogen	+130	+266	+90	+194	
150 W Halogen	+145	+293	+95	+203	
160 W Mixed	+145	+293	+125	+257	
100 W Incandescent	+145	+293	+125	+257	
200 W Incandescent	+145	+293	+125	+257	

ATX™ LDP Series Wellglass Luminaires

Flameproof. Compact Fluorescent, Halogen, Incandescent, Mixed

ATEX:
 Zone 1 and 2 – 21 and 22
 II 2 GD
 IP66 - IK08

Flameproof Wellglass Luminaires for Hazardous Areas – Ex d IIC – LDP Series			
Cable Entries	Weight kg (lb)	Volume dm ³ (in ³)	Catalog Number
2 x M20 side entries	5.0 (11.02)	35.5 (2166.34)	LDP2M20
2 x 3/4" NPT side entries	5.0 (11.02)	35.5 (2166.34)	LDP2075
1 x 3/4" NPT top entry	5.0 (11.02)	35.5 (2166.34)	LDP1075

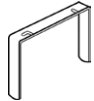
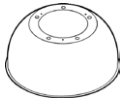
Accessories				
	Description	Weight kg (lb)	Volume dm ³ (in ³)	Catalog Number
Protective Guard				
	Zinc plated steel protective guard	0.4 (0.88)	97.0 (5919.30)	LDPG3Z
Hinged Bracket				
	Zinc plated steel hinged bracket for installation on flat surface	1.4 (3.09)	3.5 (213.58)	LDPHBZ
External Reflector				
	External white polyester reflector	3.2 (7.05)	97.0 (5919.30)	LDER1P

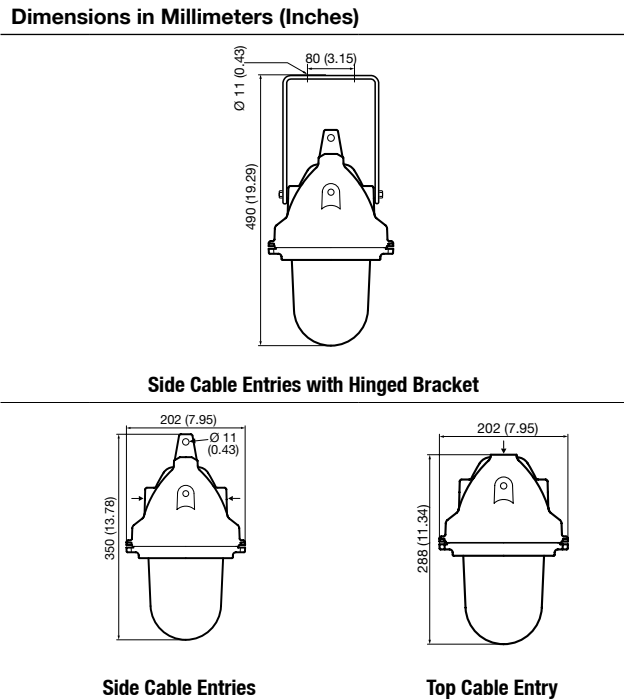
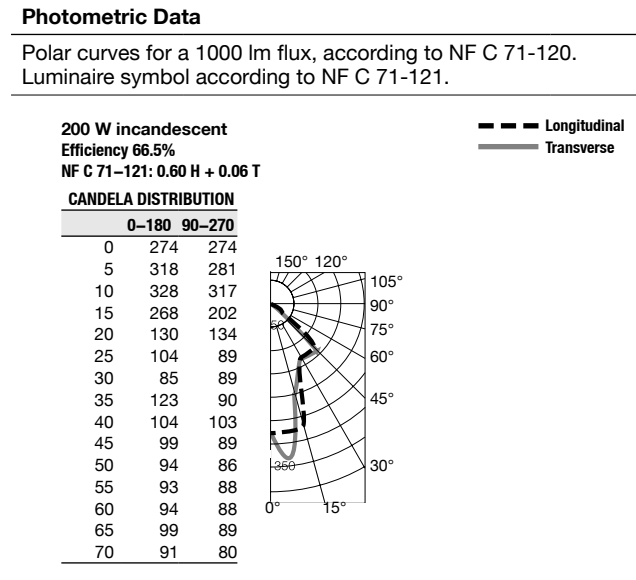

ATX™ LDM Series Wellglass Luminaires

Flameproof. HID, Compact Fluorescent, Halogen, Incandescent, Mixed

ATEX/IECEX:
Zone 1 and 2 – 21 and 22
⊕ II 2 GD
IP66/67 – IK08

Applications

- For use in hazardous locations such as plants where plastics, paints, thinners and petrochemicals are manufactured.
- Ideal for street lighting on refinery sites or oil depots and for tank lighting purposes.

Features

- E27 lamp holder.
- High temperature internal wiring.
- Threaded flame path.
- Stainless steel fastenings.
- Closed by screwing on bezel.
- Operates in any position.
- Easy and efficient wiring due to separate Ex e terminal box with wiring onto two captive terminals capacity $2 \times 6 \text{ mm}^2$ ($2 \times 0.009 \text{ in}^2$).
- External earth terminal capacity 4 mm^2 (0.006 in^2).
- $2 \times 20 \text{ mm}$ ($2 \times 0.79 \text{ in}$) clearance holes through-wire cable entries supplied with one Ex e unarmored cable gland — sealing diameter 6.5 to 14.5 mm (0.26 to 58 in) — and one blanking plug and two M20 locknuts.

Standard Materials

- Body and bezel: gray painted marine grade aluminum alloy
- Internal reflector: aluminum

ATEX/IECEX Certifications and Compliances

- Certification Type: LTd (Model LT1d)
 - Gas: Zone 1 - 2
 - Conforming to ATEX 94/9/CE: ⊕ II 2 G
 - Type of Protection: Ex de IIC
 - Temperature Class: See *T Rating for Gas Table*
 - Dust: Zone 21 - 22
 - Conforming to ATEX 94/9/CE: ⊕ II 2 D
 - Type of Protection: Ex tD A21
 - Surface Temperature: See *Surface Temperature for Dust Table*
- Ambient Temperature: $-40 \text{ }^\circ\text{C}$ to $+55 \text{ }^\circ\text{C}$ ($-40 \text{ }^\circ\text{F}$ to $+131 \text{ }^\circ\text{F}$)
- CE Declaration of Conformity: 50246
- ATEX Certificate: LCIE 02 ATEX 6165
- IECEx Certificate: IECEx LCI Ex 04.0019
- Index of Protection according EN/IEC 60529: IP66/67
- Impact Resistance (shock): IK08

EURASEC Certification

- EURASEC N° TC RU C-FR.Г505.B.00912



LDM Version



LDM Version with Guard

ATX™ LDM Series Wellglass Luminaires

Flameproof. HID, Compact Fluorescent, Halogen, Incandescent, Mixed

ATEX/IECEX:
 Zone 1 and 2 – 21 and 22
 II 2 GD
 IP66/67 - IK08

T Rating for Gas

Lamp Type and Wattage	Ambient Temperature					
	Lighting Downward			Lighting Upward		
	Ta = +40 °C (+104 °F)	Ta = +50 °C (+122 °F)	Ta = +55 °C (+131 °F)	Ta = +40 °C (+104 °F)	Ta = +50 °C (+122 °F)	Ta = +55 °C (+131 °F)
18 W Compact Fluorescent	T6	T6	T6	T6	T5	T5
150 W Halogen	T4	T4	T4	T4	T3	T3
70 W High Pressure Sodium	T5	T4	T4	T4	T4	T4
100 W High Pressure Sodium	T3	T3	T3	T3	T3	T3
150 W High Pressure Sodium	T3	T3	T3	T3	T3	T3
80 W Mercury ⑤	T4	T4	T4	T4	T4	T4
125 W Mercury ⑤	T3	T3	T3	T3	T3	T3
160 W Mixed	T3	T3	T3	T3	T3	T3
100 and 200 W Incandescent	T4	T3	T3	T3	T3	T3

Surface Temperature for Dust

Lamp Type and Wattage	Ambient Temperature — Ta = +55 °C (+131 °F)			
	Lighting Downward		Lighting Upward	
	°C	°F	°C	°F
18 W Compact Fluorescent	+80 °C	+176 °F	+95 °C	+203 °F
150 W Halogen	+130 °C	+266 °F	+195 °C	+383 °F
70 W High Pressure Sodium	+130 °C	+266 °F	+130 °C	+266 °F
100 W High Pressure Sodium	+184 °C	+363 °F	+184 °C	+363 °F
150 W High Pressure Sodium	+184 °C	+363 °F	+184 °C	+363 °F
80 W Mercury ⑤	+130 °C	+266 °F	+130 °C	+266 °F
125 W Mercury ⑤	+195 °C	+383 °F	+195 °C	+383 °F
160 W Mixed	+195 °C	+383 °F	+195 °C	+383 °F
100 and 200 W Incandescent	+195 °C	+383 °F	+195 °C	+383 °F

Flameproof Wellglass Luminaires for Hazardous Areas – Ex de IIC – LDM Series

Supplied with 1 x M20 Ex e cable gland diameter 6.5 to 14.5 mm (0.26 to 58 in) and 1 x M20 blanking plug. Lamps are not supplied.

Lamp Wattages	Voltage (+/- 10%)	Lamp Type ④		Weight kg (lb)	Volume dm³ (in³)	Catalog Number
		Ellipsoidal	Tubular			
High Pressure Sodium						
70 W ①②	230/240 Vac, 50 Hz	X	X	9 (19.84)	30 (1831)	LDML70AG1XJ
150 W ①	230/240 Vac, 50 Hz	X	X	9 (19.84)	30 (1831)	LDML15AG1XJ
Metal Halide						
150 W ①	230/240 Vac, 50 Hz	X	X	9 (19.84)	30 (1831)	LDMH15AG1XJ
Mercury Vapor						
80 W ①	230/240 Vac, 50 Hz	–	–	9 (19.84)	30 (1831)	LDMM80AG1XJ
125 W ①	230/240 Vac, 50 Hz	–	–	9 (19.84)	30 (1831)	LDMM12AG1XJ
Compact Fluorescent						
18 W	–	–	–	7.5 (16.53)	30 (1831)	LDMF18AG1
Incandescent						
200 W max. ③	–	–	–	7.5 (16.53)	30 (1831)	LDMI20AG1

① Ballast supplied.

② For lamp with built-in ignitor.

③ 150 W halogen or 160 W mixed lamps can be used.

④ Only with lamp operating in any position.

⑤ Mercury vapor and metal halide luminaires are not available for purchase within the United States. Please check with your countries governing legislation regarding allowable lamp types before ordering.

ATX™ LDM Series Wellglass Luminaires





Flameproof. HID, Compact Fluorescent, Halogen, Incandescent, Mixed

ATEX/IECEX:
Zone 1 and 2 – 21 and 22
II 2 GD
IP66/67 - IK08

Appleton

INCANDESCENT/AREA: ATEX/IECEX FLAMEPROOF

Accessories

Description	Weight kg (lb)	Volume dm ³ (in ³)	Catalog Number
Protective Guard			
 Zinc plated steel protective guard	0.4 (0.88)	9 (549.21)	LDPG1Z
External Reflector			
 External white polyester reflector	3.2 (7.05)	97 (5919.30)	LDER1P
Hinged Bracket			
 Zinc plated steel hinged bracket for installation on flat surface	3.4 (7.49)	3 (183.07)	LDMHBZ
Eyebolt			
 Zinc plated steel M10 eyebolt for suspension	0.4 (0.22)	0.2 (12.20)	LDRBM10Z
Mounting Strap			
 Gray painted aluminum	0.9 (1.98)	0.6 (36.61)	LDMSBA

Dimensions in Millimeters (Inches) – LDM Version with Hinged Bracket

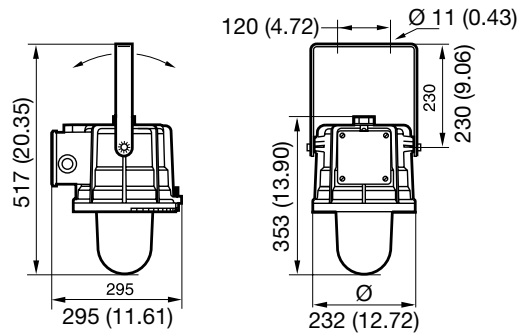

ATX™ LDM Series Wellglass Luminaires

Flameproof. HID, Compact Fluorescent, Halogen, Incandescent, Mixed

ATEX/IECEX:
 Zone 1 and 2 – 21 and 22
 II 2 GD
 IP66/67 - IK08

Photometric Data

Polar curves for a 1000 lm flux, according to NF C 71-120.
 Luminaire symbol according to NF C 71-121.

70 W High Pressure Sodium
 Efficiency 54.4%
 NF C 71-121: 0.54 F

CANDELA DISTRIBUTION		
	90-270	0-180
0	195	195
5	179	179
10	166	166
15	151	151
20	149	149
25	153	153
30	156	156
35	157	157
40	158	158
45	159	159
50	148	148
55	116	116
60	77	77
65	54	54
70	37	37

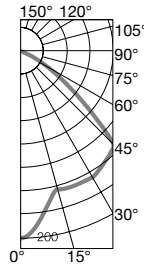

80 W Mercury
 Efficiency 46.8%
 NF C 71-121: 0.47 F

CANDELA DISTRIBUTION		
	90-270	0-180
0	158	158
5	154	154
10	145	145
15	138	138
20	136	136
25	135	135
30	134	134
35	133	133
40	133	133
45	133	133
50	125	125
55	98	98
60	67	67
65	45	45
70	31	31

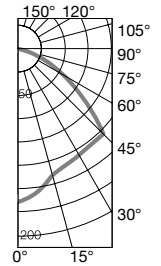

125 W Mercury
 Efficiency 48%
 NF C 71-121: 0.48 F

CANDELA DISTRIBUTION		
	90-270	0-180
0	147	147
5	143	143
10	138	138
15	133	133
20	133	133
25	136	136
30	138	138
35	137	137
40	136	136
45	134	134
50	126	126
55	104	104
60	74	74
65	50	50
70	32	32

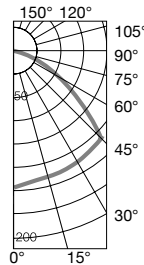

150 W High Pressure Sodium
 Efficiency 59.3%
 NF C 71-121: 0.59 D

CANDELA DISTRIBUTION		
	90-270	0-180
0	19.72	19.72
5	18.82	17.47
10	21.50	19.13
15	25.63	23.75
20	32.78	30.06
25	40.19	36.76
30	47.77	43.14
35	55.50	48.77
40	67.88	59.97
45	77.18	66.78
50	81.09	71.22
55	87.05	74.58
60	90.17	77.82
65	92.66	79.70
70	94.77	81.16
75	95.68	82.02
80	96.17	82.11
85	96.18	81.94
90	95.10	80.31

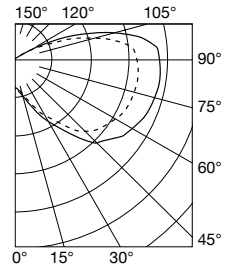

ATX™ LDB, LDG and LDR Series Wellglass Luminaires

Flameproof. High Pressure High Pressure Sodium, Mercury, Metal Halide, Mixed, Incandescent, Induction

ATEX/IECEX:
Zone 1 and 2 – 21 and 22
⊕ II 2 GD
IP66/67 - IK08

Applications

- For use in hazardous locations such as plants where plastics, paints, thinners and petrochemicals are manufactured.
- Ideal for street lighting on refinery sites or oil depots and for tank lighting purposes.

Features

- Compensated power supply.
- Power factor ≥ 0.9
- Flat joint for IIB version, threaded joint for IIC version.
- E40 lamp holder with lock thread.
- High temperature internal wiring.
- Operates in any position subject to lamp type.
- Easy and efficient wiring due to separate Ex e terminal box with wiring onto two captive terminals capacity 6 mm^2 ($2 \times 0.009 \text{ in}^2$) and two internal earth terminals capacity 6 mm^2 (0.009 in^2).
- External earth terminal capacity 4 mm^2 (0.006 in^2).
- $2 \times 20 \text{ mm}$ clearance holes through-wire cable entries supplied with one Ex e unarmored cable gland — sealing diameter 6.5 to 14.5 mm (0.26 to 0.58 in) — and one blanking plug and two M20 locknuts.

Standard Materials

- Body and bezel: gray painted marine grade aluminum alloy
- Internal reflector: aluminum
- External reflector: white painted zinc plated steel

ATEX/IECEX Certifications and Compliances

- Certification Type: LTd (Model LT2d)
 - Gas: Zone 1 - 2
 - Conforming to ATEX 94/9/CE: ⊕ II 2 G
 - Type of Protection: Ex de IIB (LDB series); Ex de IIC (LDG and LDR series)
 - Temperature Class: See *T Rating for Gas Table*
 - Dust: Zone 21 - 22
 - Conforming to ATEX 94/9/CE: ⊕ II 2 D
 - Type of Protection: Ex tD A21
 - Surface Temperature: See *Surface Temperature for Dust Table*
- Ambient Temperature: $-40 \text{ }^\circ\text{C}$ to $+55 \text{ }^\circ\text{C}$ ($-40 \text{ }^\circ\text{F}$ to $+131 \text{ }^\circ\text{F}$)
- CE Declaration of Conformity: 50246
- ATEX Certificate: LCIE 02 ATEX 6165
- IECEx Certificate: IECEx LCI Ex 04.0019
- Index of Protection according EN/IEC 60529: IP66/67
- Impact Resistance (shock): IK08

EURASEC Certification

- EURASEC N° TC RU C-FR.Г505.B.00912



LDB Version



LDB Version with Guard

ATX™ LDB, LDG and LDR Series Wellglass Luminaires

Flameproof. High Pressure High Pressure Sodium, Mercury, Metal Halide, Mixed, Incandescent, Induction

ATEX/IECEX:
Zone 1 and 2 – 21 and 22
II 2 GD
IP66/67 - IK08

Appleton®

INCANDESCENT/AREA: ATEX/IECEX FLAMEPROOF

T Rating for Gas

Lamp Type and Wattage	Ambient Temperature			
	Lighting Downward		Lighting Upward	
	Ta = +40 °C (+104 °F)	Ta = +55 °C (+131 °F)	Ta = +40 °C (+104 °F)	Ta = +55 °C (+131 °F)
85 W Induction	T6	T6	T6	T5
100 W High Pressure Sodium	T6	T5	T5	T4
150 W High Pressure Sodium	T6	T5	T4	T4
250 W High Pressure Sodium	T4	T4	T3	T3
250 W Metal Halide ①	T4	T4	T4	T3
250 W Mercury ①	T4	T4	T3	T3
250 W Mixes	T4	T4	T3	T3
300 W Incandescent	T5	T4	T3	T3
500 W Incandescent	T3	T3	T3	T2
400 W High Pressure Sodium	T4	T3	Not Available	Not Available
400 W Metal Halide ①	T4	T3	Not Available	Not Available

Surface Temperature for Dust

Lamp Type and Wattage	Ambient Temperature			
	Lighting Downward		Lighting Upward	
	°C	°F	°C	°F
85 W Induction	+80	+176	+95	+203
100 W High Pressure Sodium	+95	+203	+130	+266
150 W High Pressure Sodium	+95	+203	+130	+266
250 W High Pressure Sodium	+130	+266	+195	+383
250 W Metal Halide ①	+130	+266	+195	+383
250 W Mercury ①	+130	+266	+195	+383
250 W Mixes	+130	+266	+195	+383
300 W Incandescent	+130	+266	+195	+383
500 W Incandescent	+195	+383	+290	+554
400 W High Pressure Sodium	+134	+273	Not Available	Not Available
400 W Metal Halide ①	+134	+273	Not Available	Not Available

① Mercury vapor and metal halide luminaires are not available for purchase within the United States. Please check with your countries governing legislation regarding allowable lamp types before ordering.

ATX™ LDB, LDG and LDR Series Wellglass Luminaires

Flameproof. High Pressure High Pressure Sodium, Mercury, Metal Halide, Mixed, Incandescent, Induction

ATEX/IECEX:
Zone 1 and 2 – 21 and 22
II 2 GD
IP66/67 - IK08

Supplied with 1 x M20 Ex e cable gland — 6.5 to 14.5 mm (0.26 to 58 in) diameter — and 1 x M20 blanking plug. Lamps are not supplied, except for Induction version.

Lamp Wattages	Voltage (+/- 10%)	Lamp Type		Weight kg (lb)	Volume dm ³ (in ³)	Catalog Number
		Ellipsoidal	Tubular			
Flameproof Wellglass Luminaires for Hazardous Areas – Ex de IIB – LDB Series						
Electro Magnetic Induction ②						
85 W ①	230/240 Vac, 50/60 Hz	—	—	22.0 (48.50)	86.7 (5290.76)	LDBQ85AG2BJ
High Pressure Sodium						
100 W ①④	230/240 Vac, 50 Hz	X	X	22.0 (48.50)	86.7 (5290.76)	LDBL10AG2XJ
150 W ①④	230/240 Vac, 50 Hz	X	X	22.5 (49.60)	86.7 (5290.76)	LDBL15AG2XJ
250 W ①	230/240 Vac, 50 Hz	X	X	22.5 (49.60)	86.7 (5290.76)	LDBL25AG2XJ
Metal Halide						
250 W ①	230/240 Vac, 50 Hz	X	X	22.5 (49.60)	86.7 (5290.76)	LDBH25AG2XJ
Mercury Vapor						
250 W ①	230/240 Vac, 50 Hz	—	—	22.5 (49.60)	86.7 (5290.76)	LDBM25AG2XJ
Incandescent						
300 W to 500 W ③	—	—	—	19.0 (41.89)	86.7 (5290.76)	LDBI30AG2
Flameproof Wellglass Luminaires for Hazardous Areas – Ex de IIC – LDG series						
Electro Magnetic Induction ②						
85 W (1)	230/240 Vac, 50/60 Hz	—	—	22.0 (48.50)	86.7 (5290.76)	LDGQ85AG2BJ
High Pressure Sodium						
100 W ①	230/240 Vac, 50 Hz	X	X	22.0 (48.50)	86.7 (5290.76)	LDGL10AG2XJ
150 W ①	230/240 Vac, 50 Hz	X	X	22.5 (49.60)	86.7 (5290.76)	LDGL15AG2XJ
250 W ①	230/240 Vac, 50 Hz	X	X	22.5 (49.60)	86.7 (5290.76)	LDGL25AG2XJ
Metal Halide ⑤						
250 W ①	230/240 Vac, 50 Hz	X	X	22.5 (49.60)	86.7 (5290.76)	LDGH25AG2XJ
Mercury Vapor ⑤						
250 W ①	230/240 Vac, 50 Hz	—	—	22.5 (49.60)	86.7 (5290.76)	LDGM25AG2XJ
Incandescent						
300 W to 500 W ③	—	—	—	19.0 (41.89)	86.7 (5290.76)	LDGI30AG2
Flameproof Wellglass Luminaires for Hazardous Areas – Ex de IIC – LDR Series						
High Pressure Sodium						
400 W ①	220/230/240 Vac, 50 Hz	X	X	31.0 (68.34)	144 (8787.42)	LDRL40AG2XJ
Metal Halide ⑤						
400 W ①	220/230/240 Vac, 50 Hz	X	X	31.0 (68.34)	144 (8787.42)	LDRH40AG2XJ

① Ballast supplied.

② Service life 60,000 hours.

③ 250 W mixed lamps can be used.

④ Also available in LDM Series.

⑤ Mercury vapor and metal halide luminaires are not available for purchase within the United States. Please check with your countries governing legislation regarding allowable lamp types before ordering.

ATX™ LDB, LDG and LDR Series Wellglass Luminaires









Flameproof. High Pressure Sodium, Mercury, Metal Halide, Mixed, Incandescent, Induction

ATEX/IECEX:
Zone 1 and 2 – 21 and 22
II 2 GD
IP66/67 - IK08

Appleton

INCANDESCENT/AREA: ATEX/IECEX FLAMEPROOF

Accessories

Description	Weight kg (lb)	Volume dm ³ (in ³)	Catalog Number
Protective Guard			
 Zinc plated steel protective guard	1.2 (2.65)	27 (1647.64)	LDPG27
External Reflector			
 White painted steel	3.4 (7.50)	108 (6590.56)	LDER27
 White polyester	2.5 (5.51)	108 (6590.56)	LDER2P
Hinged Bracket – Zinc plated steel hinged bracket for installation on flat surface			
 For LDB or LDG Series	3.4 (7.49)	8 (488.19)	LDGHBZ
 For LDR Series	3.4 (7.49)	8 (488.19)	LDRHBZ
Eyebolt – Zinc plated steel eyebolt for suspension			
 M10 – For LDB or LDG Series	0.1 (0.22)	0.2 (12.20)	LDRBM10Z
 M16 – For LDR Series	0.1 (0.22)	0.2 (12.20)	LDRBM16Z
Mounting Strap – Zinc plated steel mounting straps			
 For LDB or LDG Series	0.9 (1.98)	0.6 (36.61)	LDGSBZ
 For LDR Series	0.9 (1.98)	0.6 (36.61)	LDRSBZ

Dimensions in Millimeters (Inches)

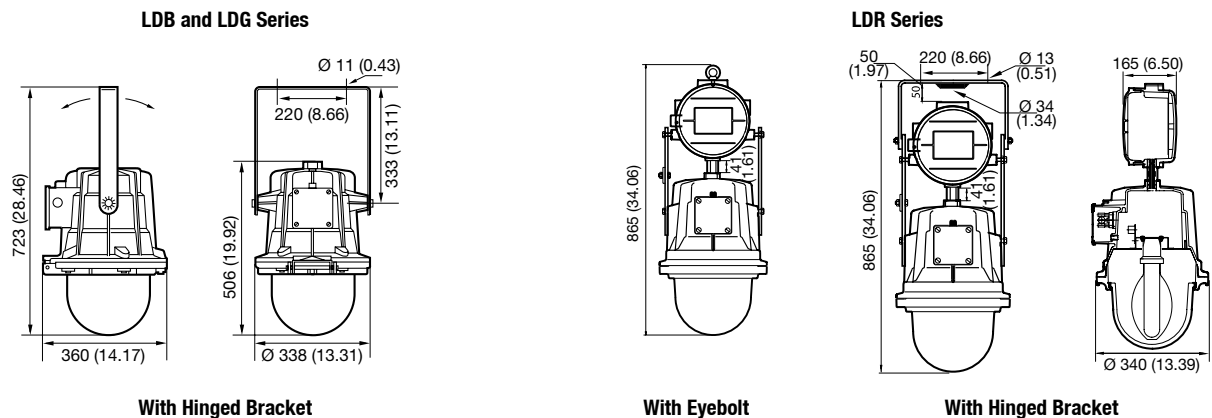

ATX™ LDB, LDG and LDR Series Wellglass Luminaires

Flameproof. High Pressure Sodium, Mercury, Metal Halide, Mixed, Incandescent, Induction

ATEX/IECEX:
 Zone 1 and 2 - 21 and 22
 II 2 GD
 IP66/67 - IK08

Photometric Data

Polar curves for a 1000 lm flux, according to NF C 71-120.
 Luminaire symbol according to NF C 71-121.

85 W Induction
 Efficiency 85.9%
 NF C 71-121: 0.62 J + 0.24 T

CANDELA DISTRIBUTION

	90-270	0-180
0	75	75
5	80	80
10	89	89
15	98	98
20	105	105
25	114	114
30	117	117
35	116	116
40	112	112
45	107	107
50	102	102
55	99	99
60	97	97
65	94	94
70	92	92

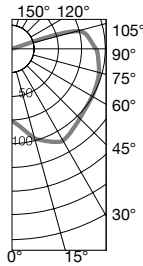

150 W High Pressure Sodium
 Efficiency 70.6%
 NF C 71-121: 0.50 J + 0.20 T

CANDELA DISTRIBUTION

	90-270	0-180
0	33	33
5	36	36
10	42	42
15	48	48
20	55	55
25	62	62
30	70	70
35	78	78
40	84	84
45	87	87
50	89	89
55	88	88
60	88	88
65	87	87
70	87	87

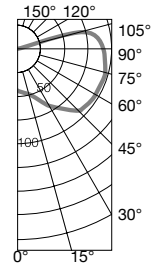

250 W High Pressure Sodium
 Efficiency 79.3%
 NF C 71-121: 0.56 J + 0.23 T

CANDELA DISTRIBUTION

	90-270	0-180
0	40	40
5	43	43
10	49	49
15	57	57
20	64	64
25	72	72
30	80	80
35	89	89
40	95	95
45	97	97
50	98	98
55	97	97
60	96	96
65	95	95
70	94	94

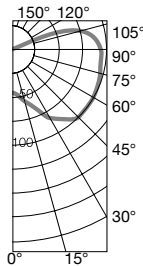

500 W Incandescent
 Efficiency 98%
 NF C 71-121: 0.71 H + 0.28 T

CANDELA DISTRIBUTION

	90-270	0-180
0	147	147
5	128	128
10	133	133
15	149	149
20	159	159
25	159	159
30	173	173
35	166	166
40	157	157
45	136	136
50	120	120
55	104	104
60	99	99
65	91	91
70	92	92

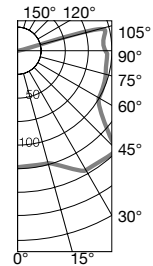

ATX™ HBDA Series Rectangular Bulkhead Luminaires

Flameproof. Compact Fluorescent, Incandescent

ATEX:
Zone 1 and 2 - 21 and 22
⊕ II 2 GD
IP66 - IK09

Applications

- For illumination of:
 - Stairways
 - Small areas
 - Emergency exit

Features

- Lamps (not supplied):
 - Incandescent 2 x 40 W
 - Compact fluorescent 1 x 18/20 W
- E27 lampholder.
- Operates in any position.
- Fixing by 2 brackets.
- Connection on two terminals 1 x 4 mm² (0.002 x 0.006 in²).
- Internal earth 1 x 4 mm² (0.002 x 0.006 in²).
- External earth 1 x 4 mm² (0.002 x 0.006 in²).
- Two M20 threaded entries.
 - Supplied with one aluminum blanking plug.

Standard Materials of Fixtures

- Body: gray painted cast aluminum
- Lens: sealed toughened lamp glass

ATEX Certifications and Compliances

- Certification Type: BRI40
 - Gas: Zones 1 and 2
 - Conforming to ATEX 94/9/CE: ⊕ II 2 G
 - Type of Protection: Ex d IIB+H₂
 - Temperature Class: T4 Incandescent, T6 Compact Fluorescent
 - Dust: Zone 21 and 22
 - Conforming to ATEX 94/9/CE: ⊕ II 2 D
 - Type of Protection: Ex tD A21
 - Surface Temperature: T135 °C (T275 °F) Incandescent, T85 °C (T185 °F) Compact Fluorescent
- Ambient Temperature: -20 °C to +40 °C (-4 °F to +104 °F)
- CE Declaration of Conformity: 50252
- ATEX Certificate: LCIE 03 ATEX 6098X
- Index of Protection according EN/IEC 60529: IP66
- Impact Resistance (shock): IK09
- Internal Volume: > 2 dm³ (122 in³) - 2 liters

Related Products

- For labels see *Labels for Emergency Lighting Units, ATX Self-Adhesive Signaling Labels for Emergency Lighting Units.*

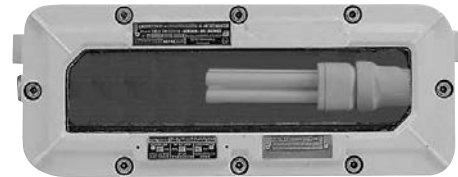

ATX™ HBDA Series Rectangular Bulkhead Luminaires

Flameproof. Compact Fluorescent, Incandescent

ATEX:
Zone 1 and 2 - 21 and 22
II 2 GD
IP66 - IK09

Appleton

INCANDESCENT/AREA: ATEX/IECEx FLAMEPROOF

Number of Lamps (not supplied)	Lamp Type and Wattage	Cable Entries	Weight kg (lb)	Volume dm ³ (in ³)	Catalog Number
1	18/20 W Compact Fluorescent	M20	5.7 (12.57)	9 (549.2)	HBDAF118
2	40 W Incandescent	M20	5.7 (12.57)	9 (549.2)	HBDAI240

Dimensions in Millimeters (Inches)

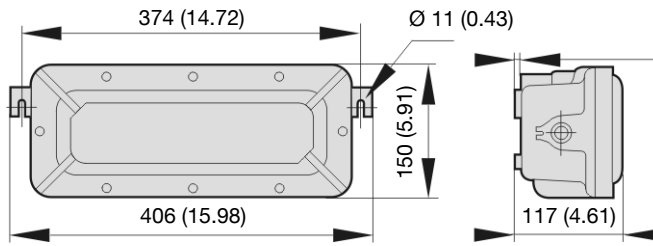

Photometric Data

Polar curves for a 1000 lm flux, according to NF C 71-120.
Luminaire symbol according to NF C 71-121.

--- Longitudinal
— Transverse

Degree	Candela Distribution	
	(0-180)	(90-270)
0	134	134
5	129	133
10	127	135
15	126	136
20	125	135
25	119	131
30	109	127
35	89	122
40	69	119
45	51	114
50	39	105
60	26	84
70	11	35

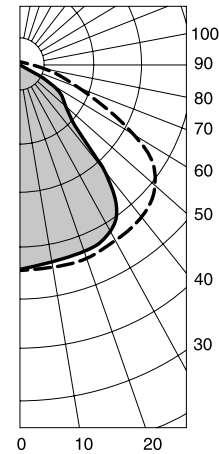

ATX™ HRD Series Tank Inspection Lights

Flameproof. Incandescent, Halogen

ATEX:
 Zone 1 and 2 - 21 and 22
 Ⓢ II 2 GD
 IP65 or IP66/IK08

Applications

- Designed to illuminate the interiors of boilers, tanks, bunkers, silos, mixers, separators, pipelines and other vessels or reactors that are normally closed.
- For use in hazardous areas where ignitable vapors, gases or highly combustible dusts are present.
- For installation in chemical and petrochemical plants, refineries and other process industries.

Features

- Type IIB version:
 - 40 W to 100 W incandescent or 50 W halogen lamp (lamp not supplied).
 - Internal aluminum reflector.
 - Operates in any position.
 - E27 lampholder.
 - Terminals: 2.5 mm² (0.004 in²).
 - Internal and external earth: 2.5 mm² (0.004 in²).
 - High temperature cable to be used.
 - Fixing by three integrated lugs.
 - One M20 threaded cable entry.
- Type IIC version:
 - 20 W to 50 W halogen lamp (lamp supplied).
 - Internal aluminum reflector.
 - Operates in any position.
 - G4 lampholder for 20 W and BA 15d for 50 W.
 - Power supply: 230 V 50/60 Hz.
 - Fitted with transformer 230/12 V for 12 V halogen lamp.
 - Terminals: 2.5 mm² (0.004 in²) terminals.
 - Internal earth: 2.5 mm² (0.004 in²).
 - External earth: 4 mm² (0.006 in²).
 - Supplied with a set of rocker hinges for mounting with DN 50 to DN 150 sightglass fittings (according to DIN 28 120).
 - One M20 threaded cable entry (via increased safety “e” box).

Standard Materials

- Body and bezel: gray painted marine grade aluminum alloy
- Lens: toughened sealed lamp glass
- Reflector: internal aluminum

ATEX Certifications and Compliances

- IIB Version
 - Certification Type: HRCd
 - Gas: Zone 1 and 2
 - Conforming to ATEX 94/9/CE: Ⓢ II 2 G
 - Type of Protection: Ex d IIB
 - Temperature class: T4 to T3
 - Dust: Zone 21 and 22
 - Conforming to ATEX 94/9/CE: Ⓢ II 2 D
 - Type of Protection: Ex tD A21
 - Surface Temperature: T130 °C to T195 °C (T266 °F to T383 °F)
 - Ambient Temperature: -40 °C to +40 °C (-40 °F to +104 °F)
 - CE Declaration of Conformity: 50241
 - ATEX Certificate: LCIE 02 ATEX 6232
 - Index of Protection according EN/IEC 60529: IP66
 - Impact Resistance (shock): IK08
 - Internal Volume: > 2 dm³ (122 in³) -2 liters



IIB Version



IIC Version (50 W)



IIC Version (20 W)



IIB Version Fitted with
DN Model Sightglass Fitting

- IIC Version
 - Certification Type: HRC 20WH (20W), HRC 50 (50W)
 - Zone 1 and 2
 - Conforming to ATEX 94/9/CE: Ⓢ II 2 G
 - Type of Protection: Ex d IIC
 - Temperature class: T4 (20W), T3 (50W)
 - Zone 21 and 22
 - Conforming to ATEX 94/9/CE: Ⓢ II 2 D
 - Type of Protection: Ex tD A21
 - Surface Temperature: 20 W: T130 °C (T266 °F), 50 W: T195 °C (T383 °F)
 - Ambient Temperature: -20 °C to +40 °C (-4 °F to +104 °F)
 - CE Declaration of Conformity: 50260 (20W), 50661 (50W)
 - ATEX Certificate: LCIE 03 ATEX 6110 (20W), LCIE 03 ATEX 6109 (50W)
 - Index of Protection according EN/IEC 60529: IP65

ATX™ HRD Series Tank Inspection Lights

Flameproof. Incandescent, Halogen

ATEX:
 Zone 1 and 2 - 21 and 22
 II 2 GD
 IP65 or IP66/IK08

Order using catalog numbering guide below or select catalog number from table below

Catalog Numbering Guide — HRD Series Tank Inspection Lights

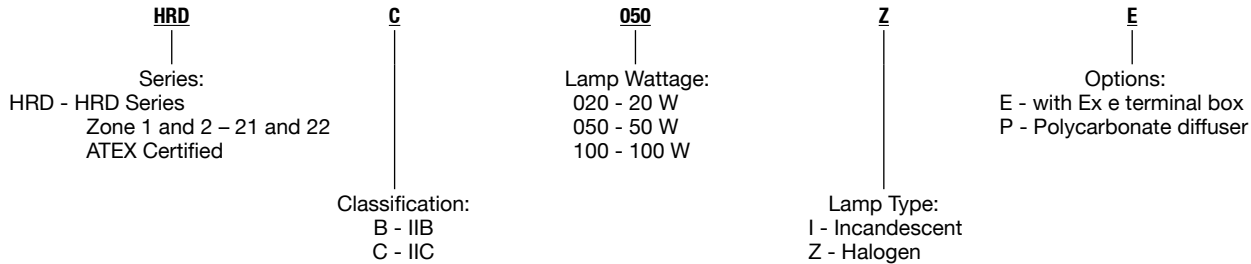

Description	Type	Weight kg (lb)	Volume dm ³ (in ³)	Catalog Number
40 W to 100 W incandescent or 50 W halogen ①	IIB	2.90 (6.39)	8.10 (494.3)	HRDB100I
20 W halogen ② 230 V, 50/60 Hz	IIC	2.30 (5.07)	3.00 (183.1)	HRDC020ZE
50 W halogen ② 230 V, 50/60 Hz	IIC	4.00 (8.82)	3.60 (219.7)	HRDC050ZE

Technical Data

Catalog Number	Version	Lamp Type and Wattage	T Rating	Ambient Temperature = +40 °C (+104 °F)	
				Gas Cable Temperature	Dust Surface Temperature
HRDB100I or NHRDB100I (lamp not supplied)	IIB	40 W Incandescent	T4	N.A.	+130 °C (+266 °F)
		60 W Incandescent	T3	+87 °C (+188.6 °F)	+137 °C (+278.6 °F)
		100 W Incandescent	T3	+107 °C (+224.6 °F)	+195 °C (+383 °F)
		50 W Halogen	T3	+82 °C (+179.6 °F)	+149 °C (+300.2 °F)

① Can also be used with compact fluorescent lamp.

② Lamp supplied.

ATX™ HRD Series Tank Inspection Lights

Flameproof. Incandescent, Halogen

ATEX:
 Zone 1 and 2 - 21 and 22
 II 2 GD
 IP65 or IP66/IK08

Dimensions in Millimeters (Inches)

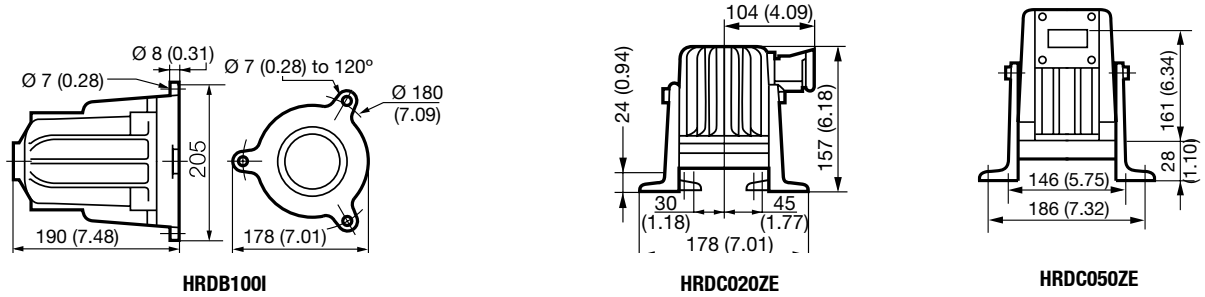

Photometric Data

IIC Versions

ISOLUX CURVE		20 W Version		Illuminance E (lux)				
Height (m)	Position	Distance (cm)	Illuminance E (lux)					
			0	10	20	30	40	
1	L		3000	1000	125	-	-	
	H		3000	900	75	-	-	
2	L		1150	750	300	100	50	
	H		1150	750	300	100	50	

50 W Version		Illuminance E (lux)					
Height (m)	Position	Distance (cm)	Illuminance E (lux)				
			0	10	20	30	40
1	L		12000	2300	375	50	-
	H		12000	2700	250	50	-
2	L		2550	1550	600	200	-
	H		2550	1800	800	200	-

IIB Versions

Polar curves for a lumen output of 1000 lm flux, according to NF C 71-120
 Luminaire symbol as per NF C 71-121

100 W Incandescent

CANDELA DISTRIBUTION

Degree	Candelas
0	155
5	145
10	136
15	135
20	133
25	127
30	112
35	90
40	66
45	54
50	46
60	29
70	11

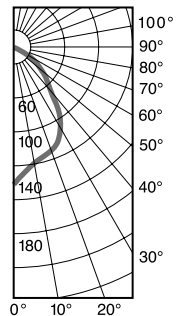

EF Series Explosionproof Floodlights

150 W, 300 W Reflector Incandescent

NEC — For 150 W PAR-38 or R-40 reflector lamps:
Class I, Groups C, D

NEC — For 300 W R-40 reflector lamps:
Class I, Group D

Applications

- Class I, Groups C and D locations such as aircraft service areas, oil and gas loading docks, distilleries.

Features

- Floodlights feature rugged, lightweight cast aluminum construction and are factory wired and sealed — no external seals are required. Choice of lamp types provides various distribution patterns. Use medium base 150W PAR-38, R-40 or 300W R40 reflector lamps.
- Easy to carry, portable model with wheelbase has handle for convenient carrying, built-on wrench allowing 135° vertical adjustment. Weighs 8.6 kgs (19 lbs).
- External cable on portable wheelbase unit (not furnished) should be 3-conductor No. 16 A.W.G. type S or SO rubber covered cable. Service end of cord should be equipped with a 2-wire, 3-pole explosionproof plug for connecting to an explosionproof receptacle.
- Terminal block has pressure terminal for connecting rubber covered cable to floodlight. Cable Connector takes a 9.5 to 12.7 mm (.375 in to .500 in) outside diameter cord. Sizes up to 15.9 mm (.625 in) diameter are available on special order.
- Permanent base model has explosionproof junction wiring chamber with 19.1 mm (3/4 in) horizontal feed-thru hubs. Vertical adjustment to 135°; horizontal to 345°.



GEFWB-30



GEFJB-30

Standard Materials

- Housing: cast aluminum
- Yoke: high-strength aluminum alloy
- Lens: thermal shock and impact resistant glass

Standard Finishes

- Floodlight housing, wheelbase, yoke and wiring compartment: aluminum enamel finished

NEC Certifications and Compliances

- UL Standard: UL 1598, UL 844
- UL Listed: E10794
- Copperfree aluminum alloy and stainless steel construction withstands 500 hours of salt-spray test. Per MIL-F-8115C

EF Series Explosionproof Floodlights

150 W, 300 W Reflector Incandescent

NEC — For 150 W PAR-38 or R-40 reflector lamps:
Class I, Groups C, D

NEC — For 300 W R-40 reflector lamps:
Class I, Group D

EF Series Explosionproof Floodlights

For 150W incandescent medium base PAR-38 (T3C) projector spot or flood, or 150W or 300W incandescent medium base R-40 (T2C) reflector spot or flood

Description	Catalog Number
Portable Flood with Wheelbase and Handle. Accommodates 9.5 mm (.375 in— .500 in) ① cable.	G-EFWB-30
Permanent Base Floodlight, for 8.0 mm (.314") conduit	G-EFJB-30

Dimensions in Millimeters (Inches)

Wheelbase Floodlight (GEFWB-30)

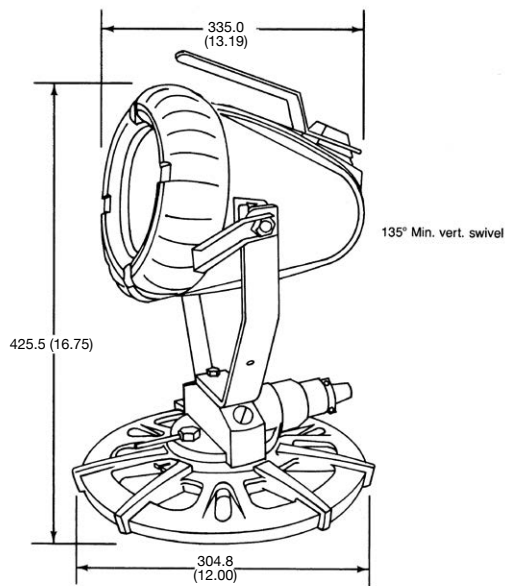

Permanent Base Floodlight (GEFJB-30)

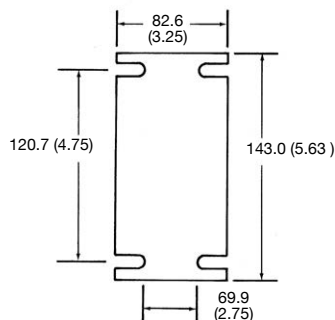
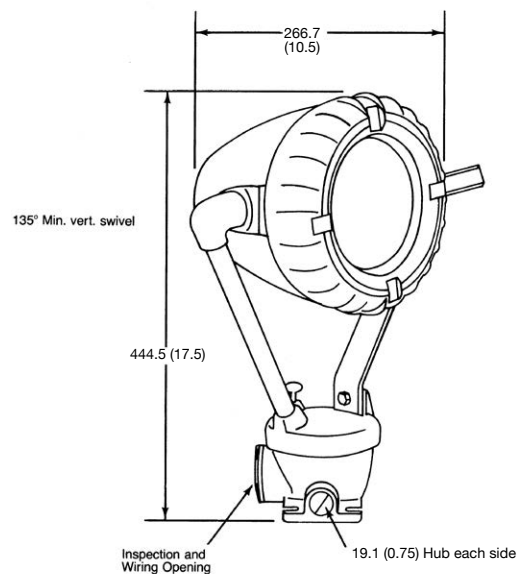

G-EFJB-30
Base Dimensions

① Can be furnished to accommodate cable sizes to 15.9 mm (.625") Dia. on special order. Cable must be ordered separately.

AHL and EHL Incandescent Factory Sealed Luminaires and Handlamps

Explosionproof

Suitable for use in Wet Locations.

NEC/CEC – AHL:
Class I, Division 1 and 2, Groups C, D
Class II, Division 1 and 2, Groups F ①, G
Class III

NEC/CEC – EHL:
Class I, Division 1 and 2, Groups C, D

Applications

- AHL general purpose explosionproof lighting fixture – an A-51 fixture with handle assembly of hook and cable clamp.
CAUTION: For safe operation, the AHL fixture weight must be supported by the hanger hook, not by the flexible cord, per the National Electrical Code.
- EHL general purpose explosionproof portable handlamp. Only 127 mm (5 in) in diameter for ease of movement.

Features:

- AHL and EHL
 - Equipped with connection block for ease of wiring and relamping.
 - Cable clamp diameters: AHL – 9.5 mm to 15.9 mm (.375 in to .625 in); EHL – 10.3 mm (.406 in) for 16-3 AWG.
 - Heat- and impact-resistant glass globes.
- AHL
 - Sturdy fixture with rugged hanging hook.
 - Safety grounding – additional terminal furnished to connect to grounding conductor.
- EHL
 - Portability, with phenolic handle and non-sparking guard with hook.
 - Easy relamping – loosen setscrew, unscrew guard, remove globe and insert lamp.
 - Safety grounding – remove cable and clamp and make connections to terminal (including one ground terminal) then tighten clamp.

Standard Materials

- Globes: heat-and impact-resistant glass
- AHL fixture unit, hook and guard: copperfree aluminum
- AHL cable clamp: brass
- EHL fixture body and handle: laminated phenolic
- EHL handle: laminated phenolic
- EHL hook: brass
- EHL guard: copperfree aluminum

Standard Finishes

- AHL fixture unit, guard, handle and hook: two-coat epoxy enamel
- AHL cable clamp: natural finish
- EHL fixture body: laminated phenolic
- EHL handle: phenolic
- EHL guard and hook: guard – natural finish; hook – zinc electroplate and clear chromate
- EHL cable clamp: laminated phenolic

NEC/CEC Certifications and Compliances

- UL Standard: UL 1598, UL 844
- EHL UL Listed: E59147
- CSA Certification: LR25428

Related Products

- The EHL handlamp may be used with AE Automatic Take-Up Reelites listed in the *Specialty Products* section and ECC Cord Connector and Plugs and Receptacles in the *Plug and Receptacles* section.



AHL



EHL

INCANDESCENT/PORTABLE: NEC/CEC EXPLOSIONPROOF

Appleton®

① To reduce the risk of ignition of hazardous atmospheres, do not use where electrically conductive dusts are present (most coal dusts are not electrically conductive).



AHL and EHL Incandescent Factory Sealed Luminaires and Handlamps

Explosionproof

Suitable for use in Wet Locations.

NEC/CEC – AHL:
Class I, Division 1 and 2, Groups C, D
Class II, Division 1 and 2, Groups F ①, G
Class III

NEC/CEC – EHL:
Class I, Division 1 and 2, Groups C, D

Description	Cable Diameter Millimeters (Inches)	"T" Ratings	Catalog Number	
AHL – Explosionproof 60 - 300 W Lighting Fixtures				
<i>CAUTION: For safe operation, weight of fixture must be supported by hanger hook, not by the flexible cord, per the National Electrical Code.</i>				
	60-100 W, A-21 (AAU-1N)	9.53 to 15.88 (.375 to .625)	T4	AHL100
	200-300 W, PS-30 (AAU-2NS)	9.53 to 15.88 (.375 to .625)	T4A	AHL200
EHL – Explosionproof 100 W Portable Handlamp ②				
	Laminated Phenolic Handle. Wiring Connection Block takes from #16 to #14 Wire.			
	100 W, A-21	10.26 (.406)	T3A	EHL100N
EHL Replacement Globe and Guard				
	Heat-resistant glass globe			XP419
	Aluminum guard with hook			XP163SA

INCANDESCENT/PORTABLE: NEC/CEC EXPLOSIONPROOF



Dimensions in Millimeters (Inches)

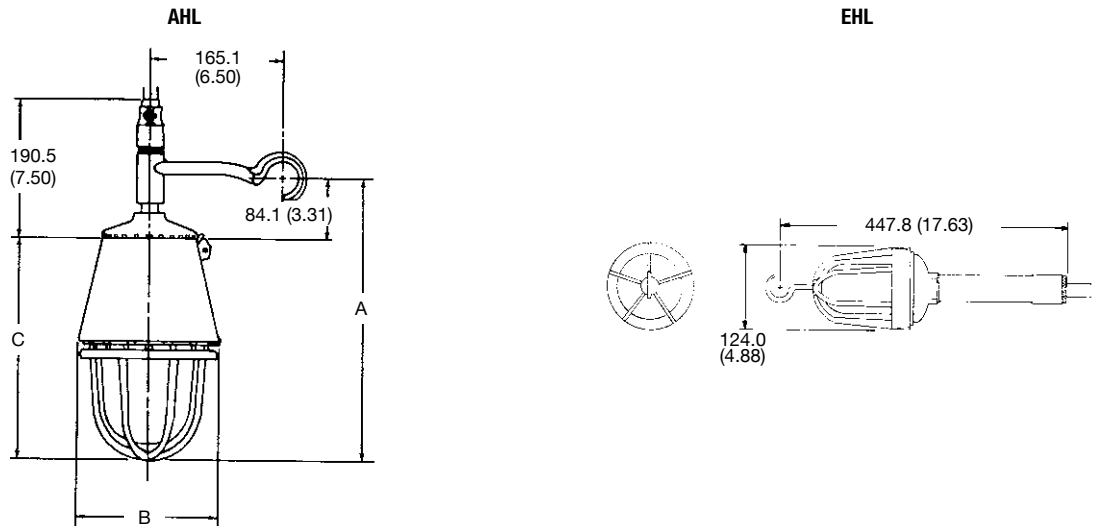

Catalog Number	A	B	C
AHL100	362.0 (14.25)	179.3 (7.06)	277.9 (10.94)
AHL200	404.9 (15.94)	223.8 (8.81)	320.8 (12.63)

① To reduce the risk of ignition of hazardous atmospheres, do not use where electrically conductive dusts are present (most coal dusts are not electrically conductive).
② Handlamp accommodates 16-3 SO cable. Contact your sales representative if 14-3 cable is required.

ATX™ PJ Series Portable Floodlights

Flameproof. Halogen

ATEX:
Zone 1 and 2 - 21 and 22
⊕ II 2 GD
IP66 - IK10

Applications

- Typical applications include aircraft manufacturing and maintenance facilities, refineries, chemical and electrochemical plants and where the permanent mounting of a fixture is not practical.

Features

- 55-70 W H3 halogen lamp.
- PK22S lamp holder.
- Connection via two terminals 1 x 2.5 mm² (0.002 x 0.004 in²).
- Internal earth connection 1 x 2.5 mm² (0.002 x 0.004 in²).
- External earth connection 1 x 4 mm² (0.002 x 0.006 in²).
- One M20 threaded rear entry.
- Operates in any position.
- Installed on cradle to allow horizontal and vertical adjustment.

Standard Materials

- Body and bezel: gray painted aluminum alloy
- Lamp glass: sealed toughened glass
- Carrying handle: plastic covering

ATEX Certifications and Compliances

- Certification Type: PJ70
 - Gas: Zones 1 - 2
 - Conforming to ATEX 94/9/CE: ⊕ II 2 G
 - Type of Protection: Ex d IIC
 - Temperature Class: T3 to T4 [See *T Rating (Gas) and Surface Temperature (Dust) Table*]
 - Dust: Zone 21 - 22
 - Conforming to ATEX 94/9/CE: ⊕ II 2 D
 - Type of Protection: Ex td A21
 - Surface Temperature: T120 °C to T142 °C (T248 °F to T288 °F) [See *T Rating (Gas) and Surface Temperature (Dust) Table*]



- Ambient Temperature: -40 °C to +55 °C (-40 °F to +131 °F)
- CE Declaration of Conformity: 50239
- ATEX Certificate: LCIE 02 ATEX 6227
- Index of Protection according EN/IEC 60529: IP66
- Impact Resistance (shock): IK10
- Internal Volume: < 2 dm³ (122 in³) - 2 liters

T Rating (Gas) and Surface Temperature (Dust) Table

Lamp Type and Wattage	Position	Gas Temperature Rating			Dust Surface Temp
		Ta = +40 °C (+104 °F)	Ta = +50 °C (+122 °F)	Ta = +55 °C (+131 °F)	at Ta = +55 °C (+131 °F)
55 and 70 Watt Halogen		T4	T3	T3	+142 °C (+288 °F)
		T4	T4	T3	+135 °C (+275 °F)
		T4	T4	T4	+120 °C (+248 °F)

INCANDESCENT/HALOGEN/PORTABLE: ATEX FLAMEPROOF

Appleton®

ATX™ PJ Series Portable Floodlights

Flameproof. Halogen

ATEX:
 Zone 1 and 2 - 21 and 22
 II 2 GD
 IP66 - IK10

Catalog Number Logic

PJ
 Series:
 PJ - PJ Series
 Zone 1 and 2 - 21 and 22
 ATEX Certified

55
 Lamp Type:
 55 - 55 Watt Halogen
 70 - 70 Watt Halogen

01B
 Supply Voltage:
 01B - 12 Vac/Vdc
 02B - 24 Vac/Vdc
 11A - 110 Vac, 50/60 Hz
 23A - 230 Vac, 50/60 Hz

Lamp Type, Wattage and Voltage	Weight kg (lb)	Volume dm ³ (in ³)	Catalog Number
55 W Halogen 12 Vac/Vdc	8 (17.64)	27 (1647.6)	PJ5501B
70 W Halogen 24 Vac/Vdc	8 (17.64)	27 (1647.6)	PJ7002B
70 W Halogen 110 V, 50/60 Hz ①	8 (17.64)	27 (1647.6)	PJ7011A
70 W Halogen 230 V, 50/60 Hz ②	8 (17.64)	27 (1647.6)	PJ7023A

Dimensions in Millimeters (Inches)

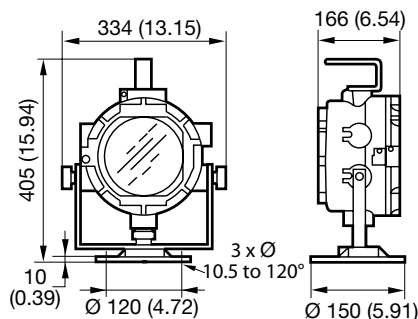

① With transformer 110/24 V (+6% -10%)
 ② With transformer 230/24 V (+6% -10%)

ATX™ HLD Series Handlamps

Flameproof. Incandescent, Halogen

ATEX:
 Zone 1 and 2 - 21 and 22
 II 2 GD
 IP66

Applications

- To provide maintenance staff with task specific portable lighting in Zone 1 hazardous locations.
- Ideal for persons requiring task specific portable lighting in refineries, oil and gas process and chemical plants.

Features

- To be supplied with SELV (Service Extra Low Voltage) 24 Vac or 30 Vdc.
- 75 W maximum for incandescent lamp.
- 70 W maximum for halogen lamp.
- E27 lamp holder for incandescent lamp (not supplied).
- PK22S lamp holder for H3 lamp (supplied).
- Connection via two terminals — 1 x 2.5 mm² (0.002 x 0.004 in²).
- One M20 threaded entry.
- Protective guard.
- Fitted with suspension hook.

Standard Materials

- Body and bezel: gray painted aluminum alloy
- Lamp glass: sealed borosilicate glass
- Protective guard: white zinc plated steel

ATEX Certifications and Compliances

- Certification Type: BLd
 - Gas: Zone 1 and 2
 - Conforming to ATEX 94/9/CE: II 2 G
 - Type of Protection: Ex d IIC
 - Temperature Class: T3 to T5 [See *T Rating (Gas) and Surface Temperature (Dust) Table*]
 - Dust: Zone 21 and 22
 - Conforming to ATEX 94/9/CE: II 2 D
 - Type of Protection: Ex tD A21
 - Surface Temperature: T110 °C to T138 °C (T230 °F to T280 °F); [See *T Rating (Gas) and Surface Temperature (Dust) Table*]

- Ambient Temperature: -20 °C to +55 °C (-4 °F to +131 °F)
- CE Declaration of Conformity: 50240
- ATEX Certificate: LCIE 02 ATEX 6164
- Index of Protection according EN/IEC 60529: IP66
- Internal Volume: < 2 dm³ (122 in³) - 2 liters



INCANDESCENT/HALOGEN/PORTABLE: ATEX FLAMEPROOF

T Rating (Gas) and Surface Temperature (Dust) Table

Type	Ambient T°	Gas				Dust Surface Temperature
		Lamp glass facing up		Lamp glass facing down		
		Ta = +40 °C (+104 °F)	Ta = +55 °C (+131 °F)	Ta = +40 °C (+104 °F)	Ta = +55 °C (+131 °F)	
40 W Incandescent	T Rating	T5	T4	T5	T4	+110 °C (+230 °F)
	Cable T°	+56 °C (+133 °F)	+71 °C (+160 °F)	+66 °C (+151 °F)	+81 °C (+178 °F)	N.A.
60 W Incandescent	T Rating	T4	T4	T4	T4	+130 °C (+266 °F)
	Cable T°	+61 °C (+142 °F)	+76 °C (+169 °F)	+73 °C (+163 °F)	+88 °C (+190 °F)	N.A.
75 W Incandescent	T Rating	T4	T3	T4	T4	+138 °C (+280 °F)
	Cable T°	+67 °C (+153 °F)	+82 °C (+180 °F)	+79 °C (+174 °F)	+94 °C (+201 °F)	N.A.
55 W Halogen	T Rating	T4	T4	T4	T4	+122 °C (+252 °F)
	Cable T°	+67 °C (+153 °F)	+82 °C (+180 °F)	+79 °C (+174 °F)	+94 °C (+201 °F)	N.A.
70 W Halogen	T Rating	T4	T4	T4	T4	+122 °C (+252 °F)
	Cable T°	+67 °C (+153 °F)	+82 °C (+180 °F)	+79 °C (+174 °F)	+94 °C (+201 °F)	N.A.

ATX™ HLD Series Handlamps

Flameproof. Incandescent, Halogen

ATEX:
 Zone 1 and 2 - 21 and 22
 II 2 GD
 IP66

Lamp Type, Wattage and Voltage	Weight kg (lb)	Volume dm ³ (in ³)	Catalog Number
75 W Maximum for Incandescent Lamp	2.8 (6.17)	13 (793.3)	HLD7502B
55 W Halogen 12 Vac/Vdc [Ⓢ]	2.8 (6.17)	13 (793.3)	HLD5501B
70 W Halogen 24 Vac/Vdc [Ⓢ]	2.8 (6.17)	13 (793.3)	HLD7002B

Dimensions in Millimeters (Inches)

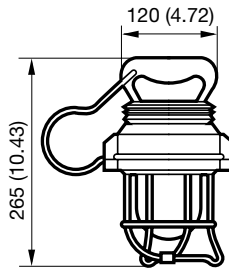

Photometric Data

Polar curves for a 1000 lm output, according to NF C 71-120
 Luminaire symbol according to NF C 71-121

Degrees	Candelas
0	23
5	37
10	51
15	68
20	83
25	82
30	82
35	82
40	82
45	77
50	72
60	61
70	73

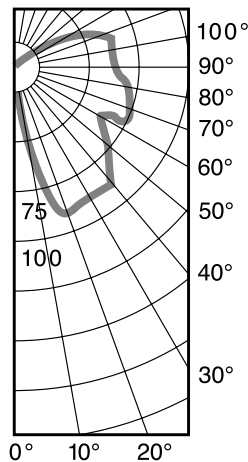

[Ⓢ] Lamp supplied.

ATX™ TCH Series Safety Flashlights

Increased Safety. Halogen, Incandescent

ATEX:
Zone 1 and 2 - 21 and 22
II 2 GD
IP66 (TCH1)
IP66/68 (TCH2)

Applications

- To provide maintenance staff with task specific portable lighting in Zone 1 hazardous areas.
- Ideal for persons requiring task specific portable lighting in refineries, oil and gas process and chemical plants.

Features

- Type TCH1:
 - Luminescent switch facilitates locating flashlight in dark.
 - Can be used to transmit a Morse code.
 - Halogen version provides twice the lumen output of incandescent lamps.
 - Hook for hands free operation.
 - Uses R20 or LR20 batteries (not included).
 - Supplied with 1 lamp.
- Type TCH2:
 - Dual optics (one at the end and one on the side) permitting:
 - Focused beam for safe movement.
 - Wide angle side beam for task specific focused lighting.
 - Ergonomic design permits easy manipulation: User can select one of the two beams with one hand.
 - Two beams can be switched on separately and not simultaneously.
 - Should one lamp fail, the second lamp will still provide illumination.
 - Flashlight is stable when placed upright on a horizontal surface.
 - Pocket clip allows for hands free work.
 - Luminescent ring allows easy locating of flashlight in dark.
 - Suspension hook for hands free use.
 - Uses 2 R20 or LR20 batteries (not included).
 - Supplied with one halogen lamp for main beam and one incandescent lamp for side beam.
 - Supplied with one special opening tool.

Standard Materials

- Type TCH1:
 - Housing: shockproof and antistatic polyamide
 - Internal reflector: polished
 - Lens: polycarbonate
 - Hardware: stainless steel
 - Switch: luminescent
- Type TCH2:
 - Housing: black polycarbonate
 - Internal reflector: polished
 - Lens: polycarbonate
 - Hardware: stainless steel
 - Ring: luminescent

ATEX Certifications and Compliances

- Certification Type: TCH1
 - Gas: Zones 1–2
 - Conforming to ATEX 94/9/CE: II 2 G
 - Type of Protection: Ex eib IIC
 - Temperature Class: T4
 - Dust: Zone 21-22
 - Conforming to ATEX 94/9/CE: II 2 D
 - Type of Protection: Ex tD A21
 - Surface Temperature: +95 °C (+203 °F)
 - Ambient Temperature: -20 °C ≤ Ta ≤ +40 °C (-4 °F ≤ To ≤ +104 °F)



TCH1



TCH2

- CE Declaration of Conformity: 50259
- ATEX Certificate: LCIE 03 ATEX 6064
- Index of Protection according EN/IEC 60529: IP66
- Certification Type: TCH2
 - Gas: Zones 1–2
 - Conforming to ATEX 94/9/CE: II 2 G
 - Type of Protection: Ex eib IIC
 - Temperature Class:
 - Incandescent PR6:T4 [+55°C (+131 °F)]
 - Krypton PR102: T4 [+55°C (+131 °F)]
 - Halogen HPR52: T4 [+40°C (104 °F)] - T3 [+55°C (+131 °F)]
 - Halogen HPR01: T4 [+55°C (+131 °F)]
 - Dust: Zone 21-22
 - Conforming to ATEX 94/9/CE: II 2 D
 - Type of Protection: Ex tD A21
 - Surface Temperature: +130 °C (+266 °F)
 - Ambient Temperature: -20 °C ≤ Ta ≤ +55 °C (-4 °F ≤ Ta ≤ +131 °F)
 - CE Declaration of Conformity: 50238
 - ATEX Certificate: LCIE 02 ATEX 6229
 - Index of Protection according EN/IEC 60529: IP66/68 (25m)

Other Certification

- Certification Type: TCH1 / TCH2
 - INMETRO Certificate: BVC11.0419 (TCH1) and BVC11.0420 (TCH2) ①

① Inmetro certification available on special request only. Contact your local sales representative for more information.

ATX™ TCH Series Safety Flashlights

Increased Safety. Halogen, Incandescent

ATEX:
 Zone 1 and 2 - 21 and 22
 II 2 GD
 IP66 (TCH1)
 IP66/68 (TCH2)

Ordering Information:

Number of lamps (included)	Type of Lamps (not included)	Number of Battery Cells	Weight kgs (lb)	Volume dm ³ (in ³)	Catalog Number
1	Incandescent — 2.5 V – 0.3 A	2	0.4 (0.88)	3.4 (207.6)	TCH12C
1	Incandescent — 3.7 V – 0.3 A	3	0.4 (0.88)	3.4 (207.6)	TCH13C
1	Halogen — 2.8 V – 0.5 A	2	0.4 (0.88)	3.4 (207.6)	TCH12H
2	Incandescent — 2.5 V – 0.3 A Halogen — 2.8 V – 0.5 A	2	0.4 (0.88)	1.9 (116.0)	TCH22M

Spare Lamps for Replacement (Lamp Holder P13, 5S)

Lamp Type	Rating	Catalog Number
Incandescent (PR6)	2.5 V – 0.3 A	TCHL25C
Incandescent (PR7)	3.7 V – 0.3 A	TCHL37C
Halogen (HPR01)	2.8 V – 0.5 A	TCHL28H

ATX™ TCH Series Safety Flashlights

Increased Safety. Halogen, Incandescent

ATEX:
 Zone 1 and 2 - 21 and 22
 II 2 GD
 IP66 (TCH1)
 IP66/68 (TCH2)

Appleton®

INCANDESCENT/HALOGEN/PORTABLE: ATEX INCREASED SAFETY

Dimensions in Millimeters (Inches)

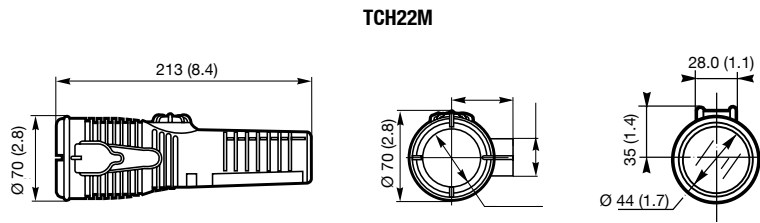
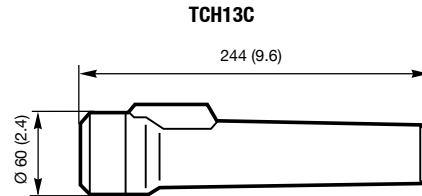
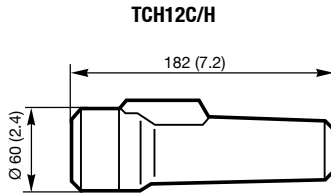

Photometric Data

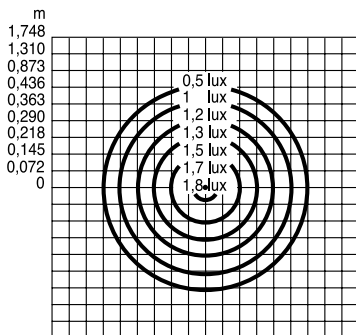

Catalog Number TCH12C (at 25 meters) Incandescent

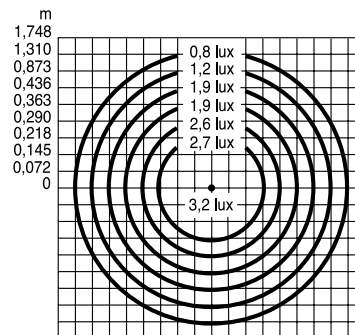

Catalog Number TCH13C (at 25 meters) Incandescent

EFKB Series Photocontrol

Explosionproof, Dust-Ignitionproof

NEC:

Class I, Division 1 and 2, Groups C, D
 Class II, Division 1 and 2, Groups E, F, G
 Class III
 NEMA 3, 7CD, 9EFG

Applications

- Encapsulated photocontrol provides automatic dusk-to-dawn lighting control.
- Typical applications include walkways, security areas and any other outdoor lighting application.
- FD factory sealed single gang cast device boxes confine arcing of device within the enclosure, preventing ignition of ignitable atmospheres during operation.
- For remote mounting.

Features

- Eliminate need for adding sealing fittings and compound at each conduit entrance.
- Smooth, rounded integral bushing in each EFD/EFDB hub protects conductor insulation.
- Accurately tapped, tapered hubs for tight, rigid joints and ground continuity.
- Corrosion resistant captive stainless steel hex head cap screws hold covers to body.

- Clearly marked terminals with brass screws assure quick, easy wiring.
- Sealing chamber has smooth, double flanges that mate both to cover and mounting enclosure to provide flame-tight joints.
- Pigtail leads from push buttons are factory sealed in sealing well.

Standard Materials

- Body: malleable iron or copperfree (4/10 of 1% max.) aluminum
- Cover: copperfree (4/10 of 1% max.) aluminum

Standard Finishes

- Body and cover: body, triple-coat—(1) zinc electroplate, (2) chromate, and (3) epoxy powder coat

NEC Certifications and Compliances

- UL Standards: UL 508, UL 698, UL 1203
- UL Listed: E10449, E81751

Photocontrol Relay Cover

	Voltage Range	Catalog Number
	120 V, 50/60 Hz	EFKB-PC120
	208-277 V, 50/60	EFKB-PC277

FD Back Box

	Type	Hub Size (Inches)	Catalog Number	
			Malleable Iron	Aluminum
	Dead-End	1/2	EFD150NLQ	EFD150ANLQ
		3/4	EFD175NLQ	EFD175ANLQ
		1	EFD110NLQ	EFD110ANLQ
Feed-Thru	1/2	EFDC150NLQ	EFDC150ANLQ	
	3/4	EFDC175NLQ	EFDC175ANLQ	
	1	EFDC110NLQ	EFDC110ANLQ	

Dimensions in Millimeters (Inches)

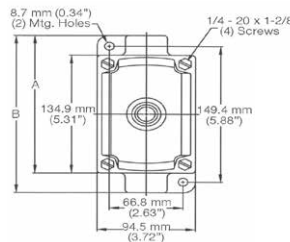

PCD2 Series Factory Sealed Hazardous Location Photocontrol

For use in Class I, Division 2, Groups A, B, C, D locations

Maintains Class I, Division 2 rating for Mercmaster III – Low Profile, Mercmaster III, and Mercmaster III – 400 Series Luminaires, Mercmaster LED

NEC/CEC:
Class I, Division 2, Groups A, B, C, D
NEMA 4X

Applications

- Encapsulated photocontrol provides automatic dusk-to-dawn lighting control in Class I, Division 2 locations.
- Typical applications include walkways, security areas and any other outdoor lighting application.
- For use with Mercmaster III – Low Profile, Mercmaster III, and Mercmaster III – 400 Series Luminaires.
- For remote mounting in FS Boxes.

- 50-400 W HID, incandescent or fluorescent, 50/60 Hz.
- 1000 V.A. Voltage/Ampere
- Minimum time delay: 15 seconds to eliminate nuisance tripping.
- Provided with (3) 18AWG stranded leads 152.4 mm (6 in) in length.
- Will fit through standard 1/2" knockout.
- Supplied with locknut and gasket.

Features



- Factory sealed design eliminates the need for an explosionproof enclosure.
- Can be easily installed in the field.
- Solid state design for performance and reliability.
- Available for 120, 208, 240, or 277 volts.

Materials

- Encapsulated with epoxy sealing compound
- FS: aluminum

NEC/CEC Certifications and Compliances

- UL Standard: 1604 – Hazardous (Classified) Locations
- cULus Recognized

	Voltage Range	Max VA	Max Current Amps	Suffix Designation Catalog Number
Factory-Installed Photocontrol - Not for ceiling or pendant cone. <i>Add to fixture catalog after voltage; i.e.: KPWBL1075MTH1.</i>				
 Mercmaster III wall mounting hood with photocontrol installed shown	120 V, 50/60 Hz	1000	—	H1
	208 V, 50/60 Hz	1000	—	H2
	240 V, 50/60 Hz	1000	—	H3
	277 V, 50/60 Hz	1000	—	H4
Photocontrol for Field Installation				
	120 V, 50/60 Hz	1000	8.3 Amp	PC120D2
	208 V, 50/60 Hz	1000	4.8 Amp	PC247D2
	240 V, 50/60 Hz	1000	4.2 Amp	
	277 V, 50/60 Hz	1000	3.6 Amp	
Photocontrol in FS Cover for Use with FS/FD Box <i>Supplied with two stainless steel screws. For neoprene gasket, order catalog number FS-GKR-1N.</i>				
	120V, 50/60 Hz	1000	8.3 Amp	FSKA-PC120D2
	208, 50/60 Hz	1000	4.8 Amp	FSKA-PC247D2
	240 V, 50/60 Hz	1000	4.2 Amp	
	277 V, 50/60 Hz	1000	3.6 Amp	

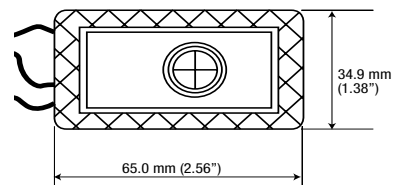
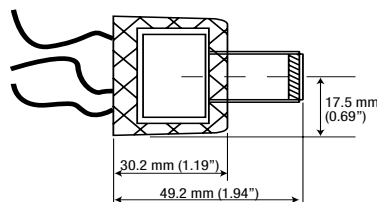
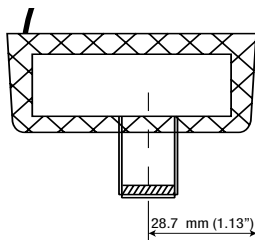

PC Series Industrial Photocontrol ^①

For Use in Ordinary Locations

For use with all Mercmaster III and Mercmaster LED luminaires

NEC/CEC:

Rated for Ordinary (Unclassified) Locations

Applications

- Durable polycarbonate housing with a clear UV stabilized window ultrasonically welded in place.
- Typical applications include walkways, security areas and any other outdoor lighting application.
- For use with all LED Series.
- For remote mounting in FS Boxes.



Features

- Solid state design for performance and reliability.
- Available for 120, 208, 240, or 277 volts.
- 1000 V.A.
- Minimum time delay: 15 seconds to eliminate nuisance tripping.
- Provided with (3) 18AWG stranded leads 152.4 mm (6.00 in) length.
- Will fit through standard 1/2" knockout.

- Supplied with locknut and gasket.
- Specifications:
 - Turn on: 1 to 4 Fc
 - Turn off: 3 to 12 Fc
 - Time Delay: 30 seconds, minimum
 - Rated Life: 5,000 operation, minimum at rated load

Materials

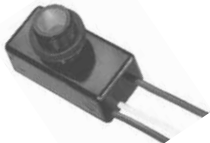
- Photocell Housing: UV resistant polycarbonate
- FS Cover: aluminum

	Voltage Range	Max VA	Max Current Amps	Suffix Designation Catalog Number
Factory Installed Photocontrol – Not for ceiling or pendant cone Add to fixture catalog after voltage; i.e.: IMLLEDA32P5BU5.				
 Mercmaster III wall mounting hood with photocontrol installed shown	120 V, 50/60 Hz	1000	—	5
	208 V, 50/60 Hz	1000	—	6
	240 V, 50/60 Hz	1000	—	7
	277 V, 50/60 Hz	1000	—	8
Photocontrol, purchased separately				
	120 V, 50/60 Hz	1000	8.3 Amp	PC120
	208 V, 50/60 Hz	1000	4.8 Amp	PC248
	240 V, 50/60 Hz	1000	4.2 Amp	
	277 V, 50/60 Hz	1000	3.6 Amp	
Photocontrol in FS Cover for Use with FS/FD Box Supplied with two stainless steel screws. For neoprene gasket, order catalog number FS-GKR-1N .				
	120 V, 50/60 Hz	1000	8.3 Amp	FSKA-PC120
	208 V, 50/60 Hz	1000	4.8 Amp	FSKA-PC247
	240 V, 50/60 Hz	1000	4.2 Amp	
	277 V, 50/60 Hz	1000	3.6 Amp	

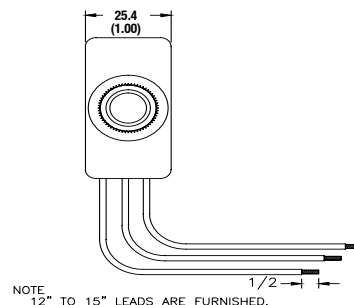
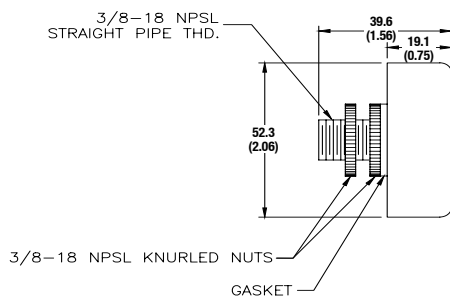

^① Fixtures with photocontrols are rated Type 3R.

BKX Rigid Fixture Hangers

UNILETS® for Use with Threaded Rigid Metal Conduit and IMC.

CEC:
Class II, Division 1 and 2, Groups E, F, G
Class III,
Enclosure 4

POLES/HANGERS: NEC/CEC EXPLOSIONPROOF FLEXIBLE FIXTURE HANGERS

Applications

- Designed for suspension of HID, fluorescent and incandescent lighting fixtures.

Features

- All fixture hangers protect fixture against wind and vibration damage.
- Cushion type for added protection where lighting fixtures are subjected to vibration.
- Available in three depths.
- Accepts JB covers for ordinary location and AHG hangers for Class II hazardous locations.

Standard Materials

- Gray iron and copperfree aluminum

CEC Certifications and Compliances

- CSA Standard: C22.2 No 18.1
- CSA Certified: 013017



BKX Shallow Box



BKX Deep Box





BKX Rigid Fixture Hangers

UNILETS® for Use with Threaded Rigid Metal Conduit and IMC.

CEC:

Class II, Division 1 and 2, Groups E, F, G
Class III,
Enclosure 4

Furnished with gasketed cover, four threaded conduit entries and 2 close-up plugs

	Fixture Stem Size (Inches)	Hub Size (Inches)	Enclosure Only Ferrous Alloy	Catalog Number		
				Enclosure Only Aluminium	With Cover Gray Iron	With Cover Aluminium
Shallow Box – 2-1/16						
	1/2	1/2	BKXS-1	BKXS-1A	BKXS-11	BKXS-11A
	1/2	3/4	BKXS-2	BKXS-2A	BKXS-21	BKXS-21A
	3/4	3/4	BKXS-2	BKXS-2A	BKXS-22	BKXS-22A
Medium Box – 2-11/16						
	1/2	1/2	BKXM-1	BKXM-1A	BKXM-11	BKXM-11A
	1/2	3/4	BKXM-2	BKXM-2A	BKXM-21	BKXM-21A
	1/2	1	BKXM-3	BKXM-3A	BKXM-31	BKXM-31A
	3/4	3/4	BKXM-2	BKXM-2A	BKXM-22	BKXM-22A
	3/4	1	BKXM-3	BKXM-3A	BKXM-32	BKXM-32A
Deep Box – 3-9/16						
	1/2	1/2	BKXD-1	BKXD-1A	BKXD-11	BKXD-11A
	1/2	3/4	BKXD-2	BKXD-2A	BKXD-21	BKXD-21A
	1/2	1	BKXD-3	BKXD-3A	BKXD-31	BKXD-31A
	3/4	3/4	BKXD-2	BKXD-2A	BKXD-22	BKXD-22A
	3/4	1	BKXD-3	BKXD-3A	BKXD-32	BKXD-32A
Covers with Gasket Attached						
	1/2		—	—	CBK-1G	CBK-1GA
	3/4		—	—	CBK-2G	CBK-2GA

Dimensions in Millimeters (Inches)

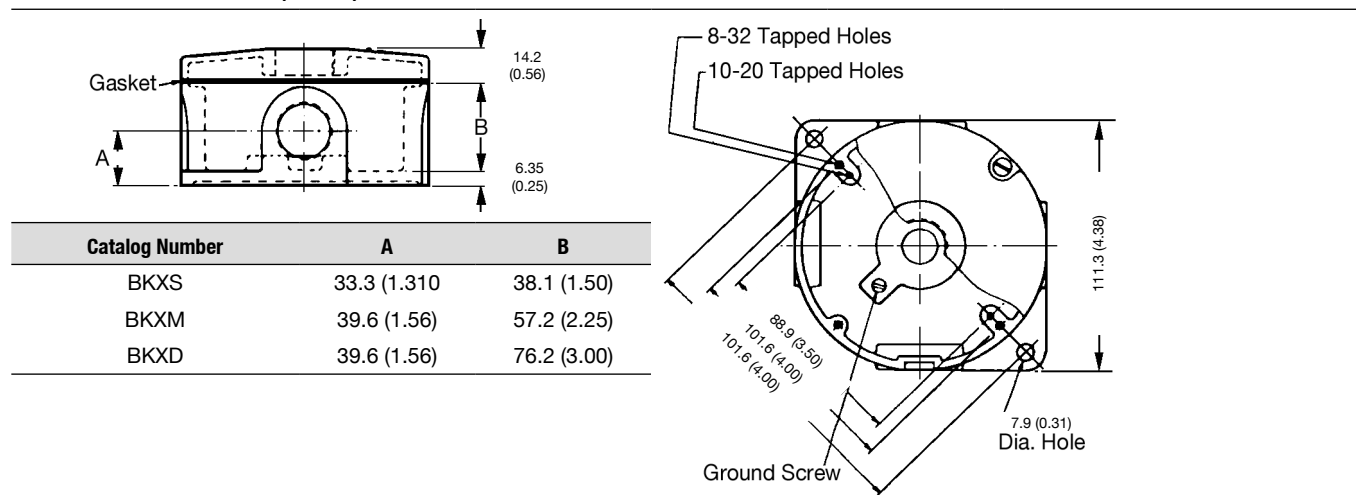

POLES/HANGERS: NEC/CEC EXPLOSIONPROOF FLEXIBLE FIXTURE HANGERS







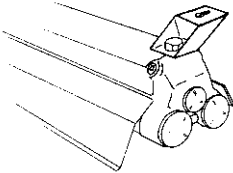
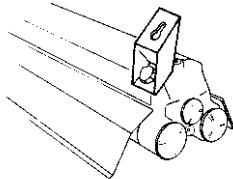

Fixture Hanger Bracket and Accessories

UNILETS® for use with Threaded Metal Conduit.

NEC/CEC:
Rated for Ordinary (Unclassified) Locations

POLES/HANGERS: NEC/CEC EXPLOSIONPROOF FLEXIBLE FIXTURE HANGERS

	NPT Size (Inches)	Support Weight kg (lbs)	Catalog Number
Fixture Hanger Brackets			
	3/4	90.0 (200)	FHS1
 <p>Ceiling Mount Projects light downward (90°). Shown mounted to Appleton AH260-118 explosionproof fluorescent lighting fixture.</p>			
 <p>Wall Mount Projects light at 45° angle. Shown mounted to Appleton AH260-118 explosionproof fluorescent lighting fixture.</p>			
Safety Support Hooks and Rigid Support for Dummy Side of Lighting Fixtures			
 <p>Installation View</p>	3/4	90.0 (200)	AC-KT
Complete assembly includes two hooks and one rigid support. Each hook supplied with a screw for closing 3/8" jaw opening. Rigid Support straddles max. 1-1/4" conduit. (Chain shown in installation view not furnished.)			
LC Steel Locking Couplings			
 <p>Installation View</p>	3/4	—	SLC75
	1	—	SLC1075
Setscrews with Allen head fasten on outside of hub and fixture stem. Prevents fixture stem from turning in hubs not normally supplied with setscrews. 3/4" fixture stem.			
Safety Support Hooks for Dummy Side of Lighting Fixtures			
Supplied with screw for closing 3/8" jaw opening.			
Male			
	1/2	90.0 (200)	EFHM-50
	3/4		EFHM-75
Female			
	1/2	90.0 (200)	EFHF-50
	3/4		EFHF-75
Rigid Support for Fluorescent Lighting Fixtures (Dummy Side)			
	1/2 and 3/4	157.5 (350)	FHS5075
Will straddle max. 1-1/4" conduit.			

Fixture Hanger Bracket and Accessories

UNILETS® for use with Threaded Metal Conduit.

NEC/CEC:
Rated for Ordinary (Unclassified) Locations

Dimensions in Millimeters (Inches) — of FHS1 Fixture Hanger Bracket

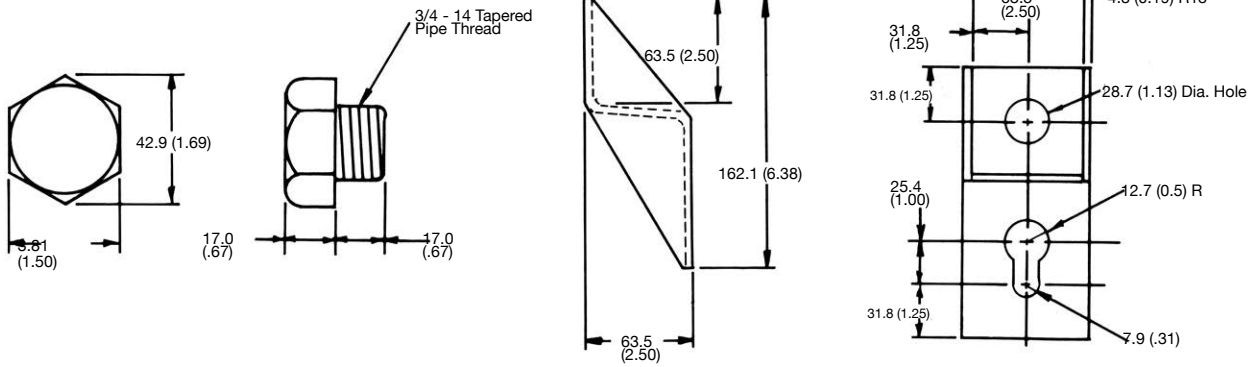

POLES/HANGERS: NEC/CEC EXPLOSIONPROOF FLEXIBLE FIXTURE HANGERS

Appleton®

CPU and EFHU Fixture Hangers

Explosionproof, Dust-Ignitionproof

UNILETS® for use with Threaded Metal Conduit.

NEC/CEC:

- Class I, Division 1 and 2, Groups C, D
- Class II, Division 1 and 2, Groups E, F, G
- Class III

Applications

- Fixture hangers and accessories for suspension of industrial type HID, incandescent, and fluorescent lighting fixtures in Class I, Class II, and Class III classified locations.
- Suitable for use in areas where moisture, dust and corrosive atmospheres are present.
- CPU and EFHU, EFHC, have smooth, rounded integral bushing in each hub to protect conductor insulation.

Features

- Boxes have cast mounting lugs. Box and hub cover provide a complete assembly for suspending lighting fixtures in classified locations.
- CPU20 Hangers are used where fixture stem is less than 12" long or with EXJF, ESD, or ESS where fixture stem is more than 12" long.
- EFHU Flexible Hangers meet NEC Sec. 501 requirement for flexible suspension where fixture stem is more than 12" long.
- Cushion design protects against vibration, and swivel action (any direction up to 15° from vertical) protects fixture if accidentally struck.
- EFHU Flexible Cushion Hangers available in three spring ranges to support fixture weights of 5.4kg to 21.8kg (12 to 48 lbs) and 21.8kg to 54.4kg (48 to 120 lbs).
- CB205 Connection Block available for connecting all wires without splices.
- Ground-joint mating surfaces assure flame-tight fit.
- Hanger has setscrew in stem hub to prevent fixture stem from turning.

Standard Materials

- CPU and EFHU: malleable iron or copperfree (4/10 of 1% max. aluminum)
- EFHU flexible hanger: brass fixture stem hub assembly

Standard Finishes

- CPU20 rigid fixture hangers body: triple-coat – (1) zinc electroplate, (2) chromate, and (3) epoxy powder coat
- CPU20 rigid fixture hangers cover: zinc electroplate and clear chromate
- Separate CPU20 covers: zinc electroplate and clear chromate.
- EFHU flexible cushion fixture hangers: triple-coat – (1) zinc electroplate, (2) chromate, and (3) epoxy powder coat

NEC/CEC Certifications and Compliances

- UL Listed: E10444
- UL Standard: 1203
- CSA Certified EFHU: 025428
- CSA Certified CPU: 013107

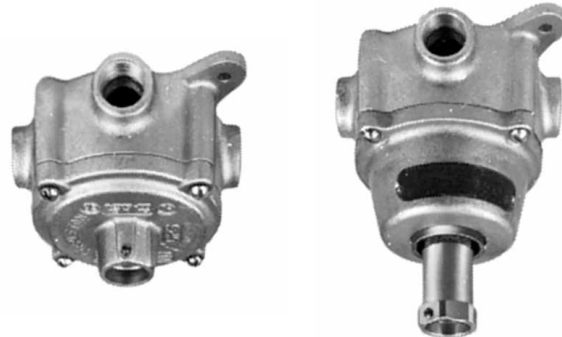

CPU

EFHU

Illustrated Features

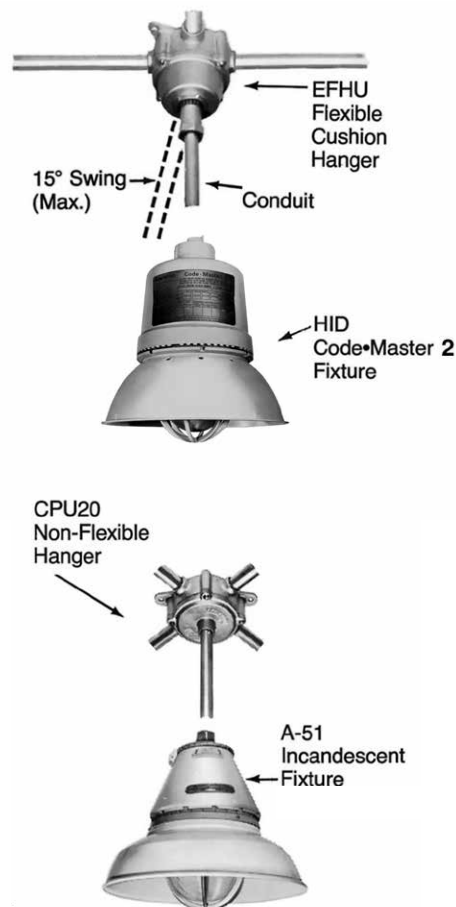

CPU and EFHU Fixture Hangers

Explosionproof, Dust-Ignitionproof

UNILETS® for use with Threaded Metal Conduit.

NEC/CEC:

Class I, Division 1 and 2, Groups C, D
 Class II, Division 1 and 2, Groups E, F, G
 Class III

POLES/HANGERS: NEC/CEC EXPLOSIONPROOF FLEXIBLE FIXTURE HANGERS

	Conduit Size (Inches)	Fixture Stem Size (Inches)	Support Weight kg (lbs)	NEC Catalog Number		CEC Catalog Number	
				Malleable Iron		Malleable Iron	Aluminum

CPU Fixture Hangers — Non-Flexible Type — Form 20



Furnished with cast mounting lugs, four threaded universal 3/4" hubs, four 3/4" to 1/2" reducers, and three 1/2" close-up plugs.

1/2 or 3/4	1/2	112.5 (250)	CPU20-50	CPU20-50CN	CPU20-50ACN
1/2 or 3/4	3/4	112.5 (250)	CPU20-75	CPU20-75CN	CPU20-75ACN

EFHU Fixture Hangers — Flexible Cushion Type — Form 20



Furnished with cast mounting lugs, four threaded universal 3/4" hubs, four 3/4" to 1/2" reducers, and three 1/2" close-up plugs.

1/2 or 3/4	3/4	5.4 to 21.6 (12 to 48)	EFHU75-48	EFHU75-48CN	—
1/2 or 3/4	3/4	21.8 to 54.0 (48 to 120)	EFHU75-120	EFHU75-120CN	—

CPU Fixture Hanger Covers — Non-Flexible Type — Form 20



Furnished with screws.

1/2	250/112.5	CPSK20-50	CPSK20-50CN	CPSK20-50ACN
3/4	250/112.5	CPSK20-75	CPSK20-75CN	CPSK20-75ACN

EFHU Fixture Hanger Covers — Flexible Cushion Type — Form 20



Furnished with screws. 3/4" to 1/2" reducer supplied for 1/2" fixture stem.

3/4	5.4 to 21.6 (12 to 48/)	EFH75-48	EFH75-48CN	—
3/4	21.8 to 54.0 (48 to 120)	EFH75-120	EFH75-120CN	—

CPU and EFHU Connection Block Accessory

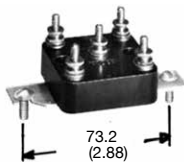

CB205



CB205CN

Mounts directly to drilled and tapped pads in CPU and EFHU hangers. Phenolic, with fastening strap and mounting screws.

5-Wire. 20-Amp, 300 V Max.	CB205	CB205CN	—
----------------------------	--------------	----------------	---

CPU and EFHU Fixture Hangers

Explosionproof, Dust-Ignitionproof

UNILETS® for use with Threaded Metal Conduit.

NEC/CEC:

Class I, Division 1 and 2, Groups C, D
 Class II, Division 1 and 2, Groups E, F, G
 Class III

POLES/HANGERS: NEC/CEC EXPLOSIONPROOF FLEXIBLE FIXTURE HANGERS

Dimensions in Millimeters (Inches)

CPU50 and CPU75 Rigid Fixture Hanger

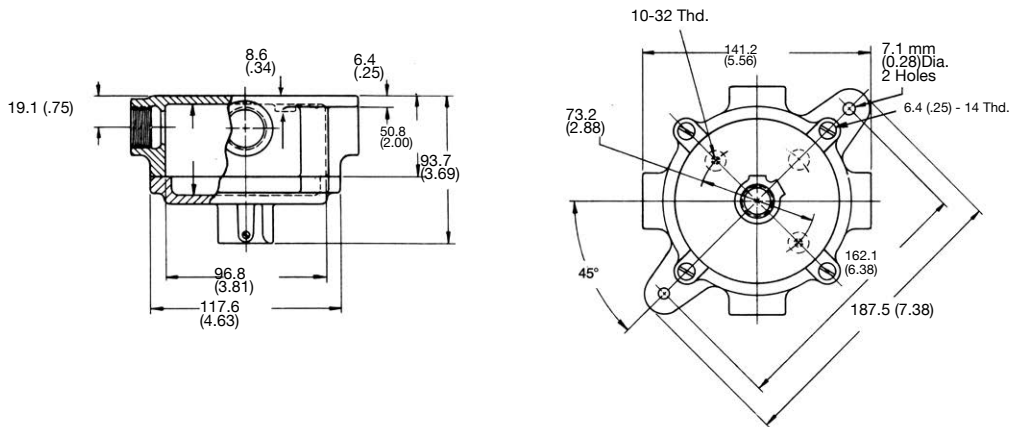

EFHU Flexible Cushion Fixture Hanger

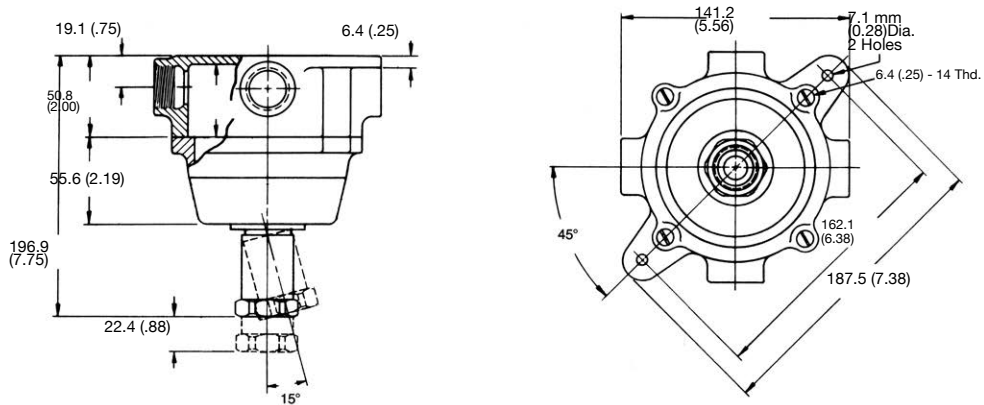

Flexible Fixture Hangers, EXJF Couplings, ESD and ESS Swivels

Explosionproof, Dust-Ignitionproof

UNILETS® for use with Threaded Metal Conduit. For Use with Rigid Fixture Hangers Where Fixture Stem is More Than 304.8 mm (12") Long.

NEC/CEC:

Class I, Division 1 and 2, Groups A, B, C, D

Class II, Division 1 and 2, Groups E, F, G

Class III

Applications

- Fixture hangers and accessories for suspension of industrial type HID, incandescent, and fluorescent lighting fixtures in Class I, Class II, and Class III classified locations.
- Suitable for use in areas where moisture, dust and corrosive atmospheres are present.

Features

- EYJF Hanger Coupling
 - Meets NEC Sec. 501 requirement for flexible suspension where fixture stem is more than 304.8 mm (12 in) long.
 - Watertight construction.
 - Convenient method for attaching explosionproof lighting fixtures to non-flexible hangers.
 - Allows free swing of lighting fixture in any direction. Absorbs shock, prevents damage to conduit and connections.
 - Assures plumb hanging of fixture.
 - Both end fittings are female with removable male close nipples. To make union end-coupling, remove nipple from either end and thread in a 1/2" or 3/4" UNY Union.
 - Female end fittings have setscrews with screwdriver slot to allow locking of conduit. Prevents turning of fixture stem and nipple.
- ESS and ESD swivels for use with rigid fixture hangers where fixture stem is more than 304.8 mm (12 in) long.

Standard Materials

- EXJF flexible hanger couplings: outer bronze braid, inner brass core with insulating liner and brass end fittings.
- ESD and ESS swivels: malleable iron.

Standard Finishes

- EXJF flexible couplings: natural finish.
- ESD and ESS swivels: triple-coat – (1) zinc electroplate, (2) chromate, and (3) epoxy powder coat.

Options

- EXJF available in stainless steel, add **-SS** to catalog number.

NEC/CEC Certifications and Compliances

- UL Listed: E10444
- UL Standard: 1203
- CSA Certified: 065182



EXJF



ESD



ESS

Illustrated Features

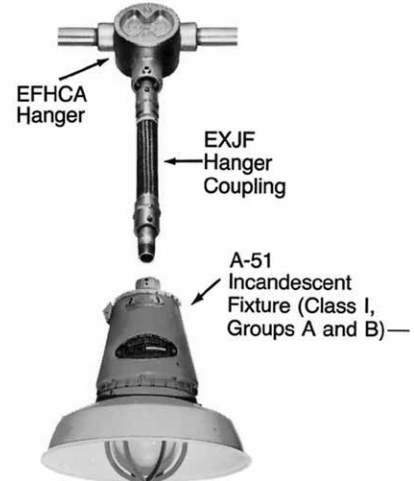

Flexible Fixture Hangers, EXJF Couplings, ESD and ESS Swivels

Explosionproof, Dust-Ignitionproof

UNILETS® for use with Threaded Metal Conduit. For Use with Rigid Fixture Hangers Where Fixture Stem is More Than 304.8 mm (12") Long.

NEC/CEC:

Class I, Division 1 and 2, Groups A, B♦, C, D

Class II, Division 1 and 2, Groups E, F, G

Class III

POLES/HANGERS: NEC/CEC EXPLOSIONPROOF FLEXIBLE FIXTURE HANGERS

	Size (Inches)	Millimeters (Inches)		Catalog Number
		Flexible Length	Overall Length	

EXJF Flexible Fixture Hanger ①



Raintight construction. Supplied with two female hubs, each with a removable close nipple. Can be used to make male to male, female to male or female to female. Setscrew with screwdriver slot allows locking of conduit—prevents fixture stem from turning. Maximum load 120 pounds.

1/2	102 (4.00)	276 (10.88)	EXJF14
3/4	102 (4.00)	278 (10.94)	EXJF24
1/2	152 (6.00)	327 (12.88)	EXJF16
3/4	152 (6.00)	329 (12.94)	EXJF26
1/2	203 (8.00)	329 (14.88)	EXJF18
3/4	203 (8.00)	379 (14.94)	EXJF28
1/2	254 (10.00)	429 (16.88)	EXJF110
3/4	254 (10.00)	430 (16.94)	EXJF210
1/2	305 (12.00)	480 (18.88)	EXJF112
3/4	305 (12.00)	481 (18.94)	EXJF212
1/2	381 (15.00)	556 (21.88)	EXJF115
3/4	381 (15.00)	557 (21.94)	EXJF215
1/2	457 (18.00)	632 (24.88)	EXJF118
3/4	457 (18.00)	633 (24.94)	EXJF218

Swivel Hangers — Setscrew with screwdriver slot allows locking of conduit — Prevents fixture stem from turning



ESD Swivel

15° swivel from center and full 360° free swing.

1/2	ESD50 ②
3/4	ESD75 ②



ESS Swivel

15° swivel from center.

1/2	ESS50 ②
3/4	ESS75 ②

① Available in stainless steel. Add suffix **-SS** to catalog number. Consult your local sales representative.

② Not CSA Certified.

♦ Shaded area indicates items suitable for Class I, Groups A and B in addition to Class I, Groups C and D; Class II, Groups E, F and G; and Class III.

Flexible Fixture Hangers, EXJF Couplings, ESD and ESS Swivel

Explosionproof, Dust-Ignitionproof

UNILETS® for use with Threaded Metal Conduit. For Use with Rigid Fixture Hangers Where Fixture Stem is More Than 304.8 mm (12") Long.

NEC/CEC:

Class I, Division 1 and 2, Groups A, B, C, D

Class II, Division 1 and 2, Groups E, F, G

Class III

Dimensions in Millimeters (Inches)

ESS Swivel

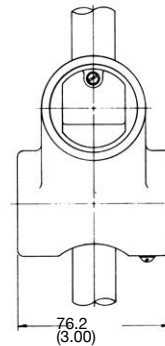
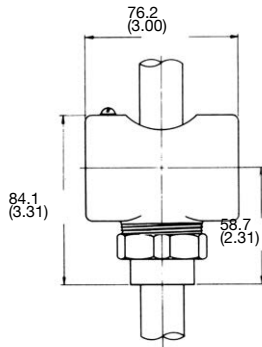

ESD Swivel

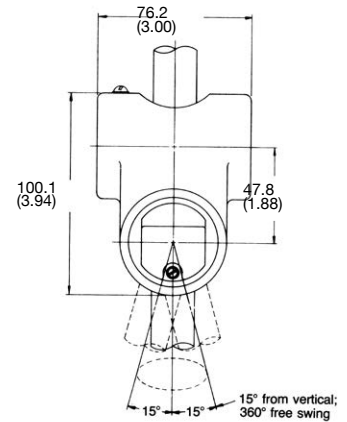

EXJF

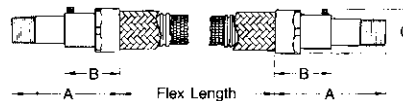

Size Inches	Dimensions in Millimeters (Inches)		
	A	B	C
1/2	85.9 (3.38)	47.8 (1.88)	36.6 (1.44)
3/4	85.9 (3.38)	47.8 (1.88)	44.5 (1.75)

POLES/HANGERS: NEC/CEC EXPLOSIONPROOF FLEXIBLE FIXTURE HANGERS



EFHC and EFHCA Fixture Hangers and Accessories

Explosionproof, Dust-Ignitionproof

UNILETS® for use with Threaded Metal Conduit.

NEC/CEC:

Class I, Division 1 and 2, Groups A^①, B, C, D

Class II, Division 1 and 2, Groups E, F, G

Class III

Applications

- Fixture hangers and accessories for suspension of industrial type HID, incandescent, and fluorescent lighting fixtures in Class I, Class II, and Class III classified locations.
- Suitable for use in areas where moisture, dust and corrosive atmospheres are present.
- EFHC and EFHCA hangers have smooth, rounded integral bushing in each hub to protect conductor insulation.

Features

- EFHC and EFHCA Fixture Hangers are used where fixture stem is less than 304.8 mm (12 in) long or with EXJF, ESD, or ESS where fixture stem is more than 304.8 mm (12 in) long.
- Raintight when used with O-Ring.
- Provided with threaded removable cover for convenience in pulling or splicing conductors.
- Mounting strap available for fastening EFHC or EFHCA to a mounting surface.
- CB202 connection block available for convenience in connecting line and fixture wires without splices.
- Hanger has setscrew in stem hub to prevent fixture stem from turning.

Standard Materials

- EFHC and EFHCA fixture hanger body: malleable iron
- EFHC and EFHCA fixture cover: copperfree (4/10 of 1% max.) aluminum
- EFHC and EFHCA mounting strap and LC locking coupling: steel

Standard Finishes

- EFHC and EFHCA fixture hanger body: triple-coat – 1) zinc electroplate, (2) chromate, and (3) epoxy powder coat
- EFHC and EFHCA fixture hanger cover: epoxy powder coat
- EFHC/EFHCA mounting strap and LC locking coupling: zinc electroplate

NEC/CEC Certifications and Compliances

- UL Listed: E10444
- UL Standard: 1203
- CSA Certified: 025875



EFHC



EFHCA

Illustrated Features

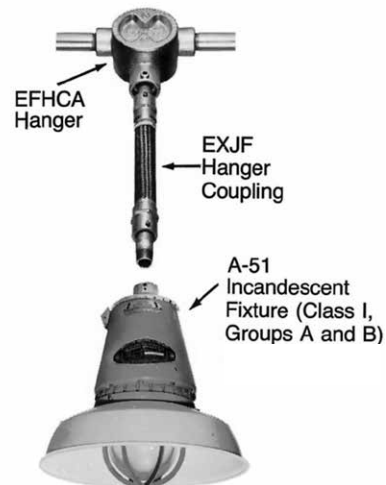

^① Suitable for Class I, Groups A, B, C, D.

EFHC and EFHCA Fixture Hangers and Accessories

Explosionproof, Dust-Ignitionproof

UNILETS® for use with Threaded Metal Conduit.

NEC/CEC:

Class I, Division 1 and 2, Groups Aⓐ, BⓈ, C, D
 Class II, Division 1 and 2, Groups E, F, G
 Class III

POLES/HANGERS: NEC/CEC EXPLOSIONPROOF FLEXIBLE FIXTURE HANGERS

	Conduit Size (Inches)	Fixture Stem Size (Inches)	Catalog Number
--	-----------------------	----------------------------	----------------

EFHC Fixture Hanger



Class I, Groups BⓈ, C and D
 Class II, Groups E, F and G
 Class III

3/4	1/2	EFHC7550 Ⓢ
3/4	3/4	EFHC7575 Ⓢ
1	1/2	EFHC1050 Ⓢ
1	3/4	EFHC1075 Ⓢ

EFHCA Fixture Hanger



Class I, Groups Aⓐ, B, C and D
 Class II, Groups E, F and G
 Class III

3/4	1/2	EFHCA7550 ⓐ
3/4	3/4	EFHCA7575 ⓐ
1	1/2	EFHCA1050 ⓐ
1	3/4	EFHCA1075 ⓐ

EFHC and EFHCA Connection Block Accessory – Porcelain



Designed to fit in hanger without fastening.
 2 Wire, 20 Amp 277 Volt
 Maximum Wire Size
 Two No. 10 AWG large terminal
 Two No. 14 AWG small terminal

CB202

EFHC and EFHCA Steel Mounting Strap



For fastening EFHC or EFHCA to a mounting surface.

Add suffix S to above EFHCA or EFHC catalog numbers.

Add suffix **S**

Dimensions in Millimeters (Inches)

EFHCA and EFHC Fixture Hangers

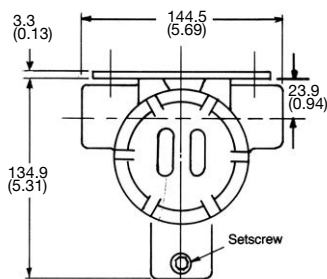

Optional Mounting Strap

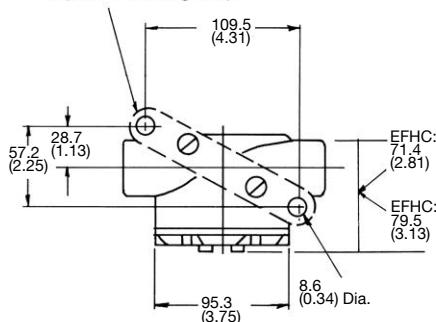

FHS Rigid Support

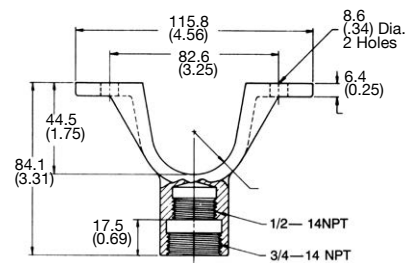

ⓐ Suitable for Class I, Groups A, B, C and D.

Ⓢ Shaded area indicates items suitable for Class I, Groups B, C and D; Class II, Groups E, F and G; and Class III. Sealing fitting must be installed adjacent to enclosure for all conduits for Group B location (EFHC Series).

GRF Conduit Outlet Boxes and Fixture Hanger Covers and Canopies

Explosionproof, Dust-Ignitionproof

UNILETS® for use with Threaded Metal Conduit.

NEC/CEC:

Class I, Division 1 and 2, Groups C, D
Class II, Division 1 and 2, Groups E, F, G
Class III

POLES/HANGERS: NEC/CEC EXPLOSIONPROOF FLEXIBLE FIXTURE HANGERS

Applications

- Fixture hangers and accessories for suspension of industrial type HID, incandescent, and fluorescent lighting fixtures in Class I, Class II, and Class III classified locations.
- Suitable for use in areas where moisture, dust and corrosive atmospheres are present.
- GRF conduit outlet boxes have smooth, rounded integral bushing in each hub to protect conductor insulation.

Features

- GRF conduit outlet box with fixture hanger canopy or cover is used where fixture stem is less than 12"/304.8 mm long or with EXJF, ESD, or ESS where fixture stem is more than 12" long.
- Raintight when used with O-Ring.
- For use with hub cover or canopy. Canopy has threaded cover opening for convenience in splicing conductors.
- Cover and canopy hubs have set-screws with screwdriver slots to allow locking of conduit. Prevents fixture stem from turning.

Standard Materials

- Malleable iron or copperfree (4/10 of 1% max.) aluminum

Standard Finishes

- Bodies: triple-coat – (1) zinc electroplate; (2) chromate, and (3) epoxy powder coat
- Covers and canopies: zinc electroplate and clear chromate

NEC/CEC Certifications and Compliances

- UL Standard: 1203
- CSA Certified: 025875



GRFC



GRF Canopy

Illustrated Features

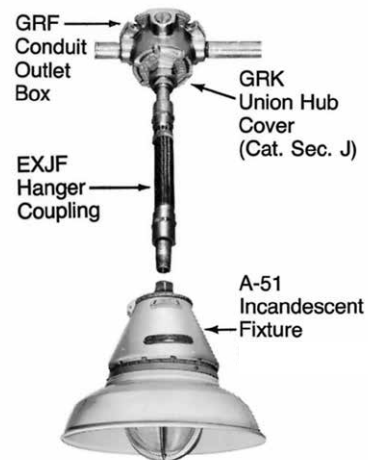

Dimensions in Millimeters (Inches)

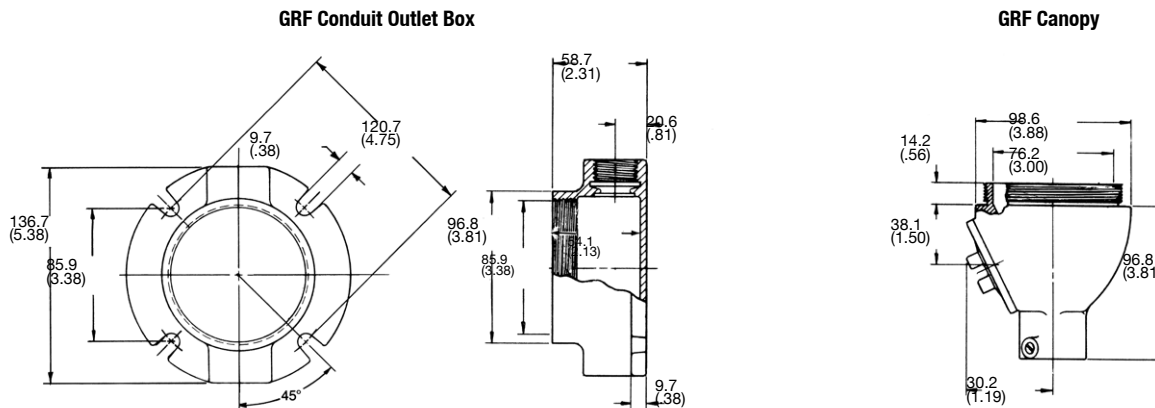







GRF Conduit Outlet Boxes and Fixture Hanger Covers and Canopies

Explosionproof, Dust-Ignitionproof

UNILETS® for use with Threaded Metal Conduit.

NEC/CEC:

Class I, Division 1 and 2, Groups C, D
 Class II, Division 1 and 2, Groups E, F, G
 Class III

	Conduit Size (Inches)	Fixture Stem Size (Inches)	NEC Catalog Number		CEC Catalog Number	
			Malleable Iron	Aluminum	Malleable Iron	
GRF Flanged Conduit Outlet Boxes – Form 1, Less Cover – For use with GRF fixture hanger canopies and covers below – Nominal diameter of cover opening is 3-3/8" – Furnished with threaded hubs and ground screw – Flange has four 3/8" mounting slots						
	1/2	–	GRFC-50LC	–	GRFC-50LCCN	
	3/4	–	GRFC-75LC	–	GRFC-75LCCN	
	1	–	GRFC-100LC	–	GRFC-100LCCN	
	1/2	–	GRFL-50LC	–	GRFL-50LCCN	
	3/4	–	GRFL-75LC	–	GRFL-75LCCN	
	1	–	GRFL-100LC	–	GRFL-100LCCN	
	1/2	–	GRFT-50LC	–	GRFT-50LCCN	
	3/4	–	GRFT-75LC	–	GRFT-75LCCN	
	1	–	GRFT-100LC	–	GRFT-100LCCN	
	1/2	–	GRFX-50LC	GRFX-50ALCCN	GRFX-50LCCN	
	3/4	–	GRFX-75LC	GRFX-75ALCCN	GRFX-75LCCN	
	1	–	GRFX-100LC	–	GRFX-100LCN	
GRF Fixture Covers – Form 1 – Furnished with external threads for attachment to GRF mounting box above						
Threaded Hub Cover						
		1/2	GRK-50	–	GRK-50CN	
		3/4	GRK-75	–	GRK-75CN	
Union Hub Cover						
		3/4	GRK-75U	–	GRK-75UCN	
GRF Fixture Canopies – Form 1 – Furnished with external threads for attachment to GRF mounting box above – Threaded cover opening on side for convenience in splicing						
		1/2	GRK-50C	–	GRK-50CCN	
	Class I, Group D	3/4	GRK-75C	–	GRK-75CCN	
		1	GRK-100C	–	GRK-100CCN	

POLES/HANGERS: NEC/CEC EXPLOSIONPROOF FLEXIBLE FIXTURE HANGERS



AHG and UNJ Flexible Fixture Hangers

Malleable Iron. Ball Type: 15° Swing. Cushion Type: 8° Swing

UNILETS® for Use with Threaded Rigid Metal Conduit and IMC.

NEC/CEC:

Listed for Ordinary (Unclassified) Locations

Applications

- AHG cushion hangers are enclosed and gasketed—ideal where dust and dampness are present.

Features

- All hangers
 - All fixture hangers protect fixture against wind and vibration damage.
 - Cushion type for added protection where lighting fixtures are subjected to vibration.
- AHG hangers
 - Enclosed and gasketed.
 - Neoprene diaphragm keeps moisture and dirt out of system.
 - Cushion type permits 8° swing from vertical.
- UNJ hangers
 - Economical general purpose hanger.
 - Permits 15° swing.

Standard Materials

- AHG fixture hangers: malleable iron
- UNJ fixture hangers: malleable iron and steel

Standard Finishes

- AHG: triple-coat—(1) zinc electroplate, (2) chromate, and (3) epoxy powder coat
- UNJ: malleable iron and steel parts, zinc electroplate and clear chromate

NEC/CEC Certifications and Compliances

- CSA Certified: 065180 (UNJ)
- UL Listed: E109438 (AWG)



AHG5050





UNJ-50

Illustrated Features

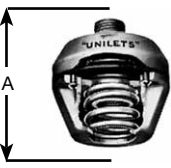

POLES/HANGERS: NEC/CEC ORDINARY LOCATION FLEXIBLE FIXTURE HANGERS

Appleton®

	Fixture Stem Size (Inches)	Male Nipple Size (Inches)	Length A mm (in)	Support Weight kg (lbs)	Catalog Number
AHG — Fixture Hangers — Cushion Type — Enclosed and Gasketed — Cushions 18.0 kg (40 lbs.)					
 <p>Cushion</p>	1/2	1/2	81.0 (3.19)		AHG5050
	1/2	3/4	81.0 (3.19)	18 (40)	AHG7550
	3/4	3/4	81.0 (3.19)		AHG7575
UNJ — Fixture Hangers — Malleable Iron and Steel — Ball Type					
 <p>Ball</p>	1/2	1/2	101.6 (4.00)		UNJ-50
	3/4	3/4	101.6 (4.00)	54 (120)	UNJ-75

AL Ball and Cushion Flexible Fixture Hangers

UNILETS® for Use with Threaded Rigid Metal Conduit and IMC. Ball Joint Permits 20° Swing.

NEC:

Listed for Ordinary (Unclassified) Locations

Applications

- Designed for suspension of HID, fluorescent and incandescent lighting fixtures.
- Functions as combination conduit outlet box and hanger.

Features

- Protects fixture against wind and vibration damage.
- Cushion type for added protection where lighting fixtures are subjected to vibration.
- Dual function—conduit outlet box and fixture hanger.
- Choice of ball or cushion type.
- Swivel joint construction—allows 20° swing from vertical.
- Cushion style, with conical spring, supports up to 54 kg (120 lbs).
- Cushion type has setscrew for locking fixture stem.
- Fixture and hanger stem can be wired at work bench.
- Connection block available for convenient wiring of fixture leads.

Standard Materials

- Malleable iron with steel cover

Standard Finishes

- Malleable iron parts: triple-coat—(1) zinc electroplate, (2) chromate, and (3) epoxy powder coat
- Steel parts: zinc electroplate

NEC Certifications and Compliances

- UL Listed: E109438



ALA — Ball Hanger



ALC — Ball Hanger



ALL — Cushion Hanger



ALT — Cushion Hanger

Illustrated Features

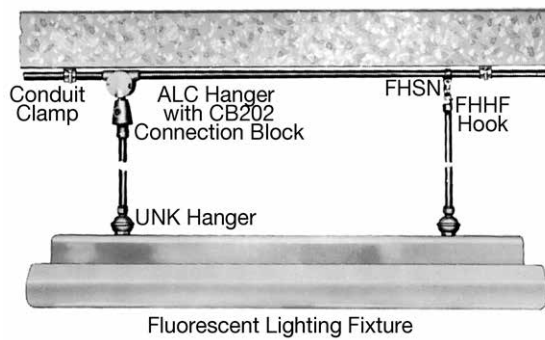





POLES/HANGERS: NEC/CEC ORDINARY LOCATION FLEXIBLE FIXTURE HANGERS



AL Ball and Cushion Flexible Fixture Hangers

UNILETS® for Use with Threaded Rigid Metal Conduit and IMC. Ball Joint Permits 20° Swing.

NEC:
Listed for Ordinary (Unclassified) Locations

	Conduit Size (Inches)	Fixture Stem Size (Inches)	Support Weight (kg (lbs))	Catalog Number
ALA – Ball Hanger				
	1/2	1/2	112.5 (250)	ALA50-B
	3/4	1/2		ALA7550-B
	3/4	3/4	112.5 (250)	ALA75-B
ALA – Cushion Hanger – Furnished with a 3/4" to 1/2" reducer for 1/2" stems				
	1/2	3/4 or 1/2	1.4 to 5.4 (3 to 12)	ALA50-12
	3/4	3/4 or 1/2		ALA7575-12
	1/2	3/4 or 1/2	5.4 to 21.6 (12 to 48)	ALA50-48
	3/4	3/4 or 1/2		ALA7575-48
	1/2	3/4 or 1/2	21.6 to 54.0 (48 to 120)	ALA50-120
	3/4	3/4 or 1/2		ALA7575-120
ALC – Ball Hanger				
	1/2	1/2	112.5 (250)	ALC50-B
	3/4	1/2		ALC7550-B
	1	1/2		ALC1050-B
	3/4	3/4	112.5 (250)	ALC75-B
	1	3/4		ALC1075-B
ALC – Cushion Hanger – Furnished with a 3/4" to 1/2" reducer for 1/2" stems				
	1/2	3/4 or 1/2	1.4 to 5.4 (3 to 12)	ALC50-12
	3/4	3/4 or 1/2		ALC7575-12
	1	3/4 or 1/2		ALC1075-12
	1/2	3/4 or 1/2	5.4 to 21.6 (12 to 48)	ALC50-48
	3/4	3/4 or 1/2		ALC7575-48
	1	3/4 or 1/2		ALC1075-48
	1/2	3/4 or 1/2	21.6 to 54.0 (48 to 120)	ALC50-120
	3/4	3/4 or 1/2		ALC7575-120
	1	3/4 or 1/2		ALC1075-120





POLES/HANGERS: NEC/CEC ORDINARY LOCATION FLEXIBLE FIXTURE HANGERS



AL Ball and Cushion Flexible Fixture Hangers

UNILETS® for Use with Threaded Rigid Metal Conduit and IMC. Ball Joint Permits 20° Swing.

NEC:
Listed for Ordinary (Unclassified) Locations

	Conduit Size (Inches)	Fixture Stem Size (Inches)	Support Weight kg (lbs)	Catalog Number
ALL – Ball Hanger				
	1/2	1/2	112.5 (250)	ALL50-B
	3/4	1/2		ALL7550-B
	3/4	3/4	112.5 (250)	ALL75-B
ALL – Cushion Hanger – Furnished with a 3/4" to 1/2" reducer for 1/2" stems				
	1/2	3/4 or 1/2	1.4 to 5.4 (3 to 12)	ALL50-12
	3/4	3/4 or 1/2		ALL7575-12
	1/2	3/4 or 1/2	5.4 to 21.6 (12 to 48)	ALL50-48
	3/4	3/4 or 1/2		ALL7575-48
	1/2	3/4 or 1/2	21.6 to 54 (48 to 120)	ALL50-120
	3/4	3/4 or 1/2		ALL7575-120
ALT – Ball Hanger				
	1/2	1/2	112.5 (250)	ALT50-B
	3/4	1/2		ALT7550-B
	1	1/2		ALT1050-B
	3/4	3/4	112.5 (250)	ALT75-B
	1	3/4	112.5 (250)	ALT1075-B
ALT – Cushion Hanger – Furnished with a 3/4" to 1/2" reducer for 1/2" stems				
	1/2	3/4 or 1/2	1.4 to 5.4 (3 to 12)	ALT50-12
	3/4	3/4 or 1/2		ALT7575-12
	1	3/4 or 1/2		ALT1075-12
	1/2	3/4 or 1/2	5.4 to 21.6 (12 to 48)	ALT50-48
	3/4	3/4 or 1/2		ALT7575-48
	1	3/4 or 1/2		ALT1075-48
	1/2	3/4 or 1/2	21.6 to 54 (48 to 120)	ALT50-120
	3/4	3/4 or 1/2		ALT7575-120
	1	3/4 or 1/2		ALT1075-120

POLES/HANGERS: NEC/CEC ORDINARY LOCATION FLEXIBLE FIXTURE HANGERS









AL Ball and Cushion Flexible Fixture Hangers

UNILETS® for Use with Threaded Rigid Metal Conduit and IMC.

NEC:
Listed for Ordinary (Unclassified) Locations

POLES/HANGERS: NEC/CEC ORDINARY LOCATION FLEXIBLE FIXTURE HANGERS

	Size (Inches)	Support Weight kg (lbs)	Catalog Number
AL – Hanger Bodies			
	1/2	(Refer to Cushion and Ball Fixture Stems Below)	ALA50
	3/4		ALA75
	1/2	(Refer to Cushion and Ball Fixture Stems Below)	ALC50
	3/4		ALC75
	1		ALC100
	1/2	(Refer to Cushion and Ball Fixture Stems Below)	ALL50
	3/4		ALL75
	1/2	(Refer to Cushion and Ball Fixture Stems Below)	ALT50
	3/4		ALT75
	1		ALT100
AL – Ball Fixture Stem			
	1/2	112.5 (250)	BJ50
	3/4		BJ75
AL – Cushion Fixture Stems			
Fixture stem tapped for 3/4"; 3/4" to 1/2" reducer furnished for 1/2" stems. With setscrew for locking fixture stem.			
	3/4 or 1/2	1.4-5.4 (3-12)	CJC75-12
	3/4 or 1/2	5.4-21.6 (12-48)	CJC75-48
	3/4 or 1/2	21.6-54.0 (48-120)	CJC75-120
AL – Porcelain Connection Block			
	2 Wire, 20 Amp, 277 Volt Maximum Wire Size Two No. 10 AWG Large Terminal Two No. 14 AWG Small Terminal		CB202

AL Fixture Hanger Dimensions – Millimeters (Inches)

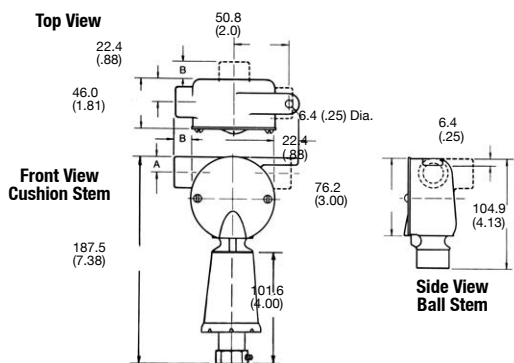

Conduit Trade Size	Dimensions in Millimeters (Inches)	
	A	B
1/2"	4.2 (0.56)	17.5 (0.69)
3/4"	17.5 (0.69)	17.5 (0.69)
1"	22.4 (0.88)	20.6 (0.81)

JB and GS Flexible Fixture Hangers

Malleable Iron. Ball Type, 15° Swing; Cushion Type, 8° Swing

UNILETS® for Use with Threaded Rigid Metal Conduit and IMC.

NEC/CEC:

Listed for Ordinary (Unclassified) Locations

Applications

- JB, GS and AHG cushion hangers are enclosed and gasketed—ideal where dust and dampness are present.
- JB and GS hangers designed for use with JB and GS boxes.

Features

- All hangers
 - All fixture hangers protect fixture against wind and vibration damage.
 - Cushion type for added protection where lighting fixtures are subjected to vibration.
- JB and GS hangers
 - Mount directly to JB and GS cast conduit outlet boxes.
 - Choice of ball or cushion type.
 - Ball type permits 15° swing, cushion type 8° swing from vertical
 - Cushion type is enclosed and gasketed.

Standard Materials

- Malleable iron

Standard Finishes

- GS: triple-coat—(1) zinc electroplate, (2) chromate, and (3) epoxy powder coat
- JB series support: zinc electroplate and clear chromate

NEC/CEC Certifications and Compliances

- JB and GS cushion type hangers suitable for classified location use in Class I, Division 2 areas, if installed in compliance with NEC 501-9(b)
- CSA Certified: 065180
- UL Listed: E109438

Illustrated Features

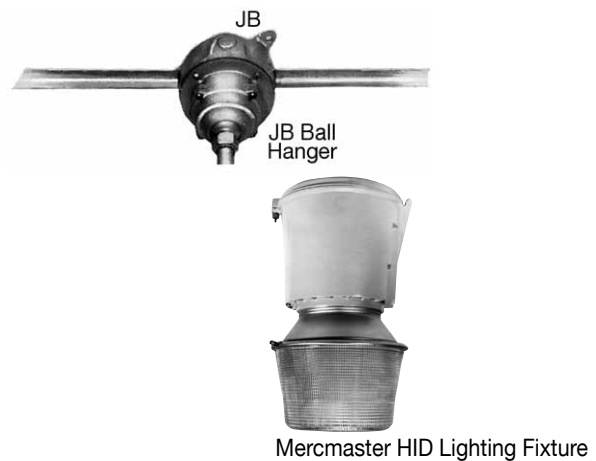

JBK-50-BS



JBK-50-CS



GSK-50-20B

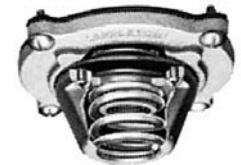

GSK-50-20C

POLES/HANGERS: NEC/CEC ORDINARY LOCATION FLEXIBLE FIXTURE HANGERS

Appleton®

JB and GS Flexible Fixture Hangers





Malleable Iron. Ball Type, 15° Swing; Cushion Type, 8° Swing

UNILETS® for Use with Threaded Rigid Metal Conduit and IMC.

NEC/CEC:

Listed for Ordinary (Unclassified) Locations

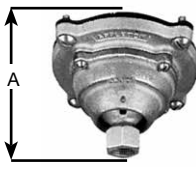
POLES/HANGERS: NEC/CEC ORDINARY LOCATION FLEXIBLE FIXTURE HANGERS

	Fixture Stem Size (Inches)	Male Nipple Size (Inches)	Length A mm (in)	Support Weight kg (lbs)	Catalog Number
JB—Fixture Hanger Covers — For use with JBX, JBDX and JBLX bodies — Furnished with gasket and screws					
	Ball Type				
	1/2		65.0 (2.56)	113 (250)	JBK-50-BS
3/4		65.0 (2.56)	JBK-75-BS		
	Cushion Type		Enclosed and gasketed. Cushions 18.0 kg. (40 lbs.)		
	1/2		41.4 (1.63)	18 (40)	JBK-50-CS
3/4		41.4 (1.63)	JBK-75-CS		
GS—Fixture Hanger Covers (Form 20) — For use with GS and GSU bodies — Furnished with gasket and screws					
	Ball Type				
	1/2		76.2 (3.00)	250 (113)	GSK-50-20B
3/4		82.6 (3.25)	GSK-75-20B		
	Cushion Type		Enclosed and gasketed. Cushions 18.0 kg. (40 lbs.)		
	1/2		50.8 (2.00)	40 (18)	GSK-50-20C
3/4		50.8 (2.00)	GSK-75-20C		

SSH Flexible Fixture Hangers

Heavy Duty Outlet Box Swivel. Ball Joint Swivel Permits 20° Swing

UNILETS® for Use with Threaded Rigid Metal Conduit and IMC.

NEC/CEC:

Listed for Ordinary (Unclassified) Locations

Applications

- Designed for suspension of HID, fluorescent and incandescent lighting fixtures.
- SSH heavy duty swivel hangers for mounting to outlet and concrete boxes.

Features

- Protect fixture against wind and vibration damage.
- Cushion type for added protection where lighting fixtures are subjected to vibration.
- Heavy duty—support fixtures up to 22.7 kg (50 lbs).
- Steel plate serves as cover for outlet or concrete box.
- Ball type swivel joint permits 20° swing from vertical.

Standard Materials

- Malleable iron and steel

Standard Finishes

- Malleable iron and steel parts: zinc electroplate and clear chromate

NEC/CEC Certifications and Compliances

- CSA Certified: 065180
- UL Listed: E2527
- UL Standard: 514A



11360



11362

Illustrated Features



Cat. No. 11360 Safety Swivel Hanger installed in OCR3-1/2 Concrete Box with OCP3/8 Plate



Cat. No. 11362 Safety Swivel Hanger installed in a 4-11/16 Square Box shown with NBFS-38 (not included)

Industrial lighting installations often employ the use of extra heavy fixtures requiring a properly anchored swivel attachment, assuring positive safety to carry the necessary weight. In the Type “SSH” Safety Swivel Hanger, the weight of the entire suspended unit is borne by a fixture stud instead of relying upon the screws and screw ears of the box or ring for support. The “SSH” hanger is furnished with a steel plate to serve as a cover for the 4” Concrete, Octagonal, and 4-11/16” Square boxes.

POLES/HANGERS: NEC/CEC ORDINARY LOCATION FLEXIBLE FIXTURE HANGERS



Appleton®

SSH Flexible Fixture Hangers

Heavy Duty Outlet Box Swivel. Ball Joint Swivel Permits 20° Swing

UNILETS® for Use with Threaded Rigid Metal Conduit and IMC.

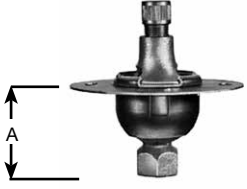
NEC/CEC:
Listed for Ordinary (Unclassified) Locations

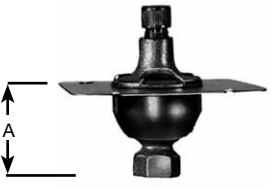
	Fixture Stem Size (Inches)	Fixture Stud Size (Inches)	Length A mm (in)	Support Weight kg (lbs)	Catalog Number
Concrete Box – Safety Swivel Hanger – For Concrete Box 2-1/2” to 4” Deep					
	1/2	3/8	55.6 (2.19)	22.5 (50)	11360
Octagonal Box – Safety Swivel Hanger – For 4” Octagonal Box 1-1/2” or 2-1/8” Deep					
	1/2	3/8	55.6 (2.19)	22.5 (50)	11355
Square Box – Safety Swivel Hanger – For 4-11/16” Square Box 1-1/2” or 2-1/8” Deep					
	1/2	3/8	55.6 (2.19)	22.5 (50)	11362

POLES/HANGERS: NEC/CEC ORDINARY LOCATION FLEXIBLE FIXTURE HANGERS

Appleton®

SHC Flexible Fixture Hangers

Outlet Box Mounted Series

UNILETS® for Use with Threaded Rigid Metal Conduit and IMC.

NEC/CEC:

Listed for Ordinary (Unclassified) Locations

Applications

- Designed for suspension of HID, fluorescent and incandescent lighting fixtures.
- SHC fixture hanger covers for mounting to 3-1/4" and 4" octagonal boxes and 4" square boxes.

Features

- Protect fixture against wind and vibration damage.
- Cushion type for added protection where lighting fixtures are subjected to vibration.
- Ball type swivel joint permits 20° swing from vertical.
- Support fixtures with a maximum weight of 22.7 kg (50 lbs).

Standard Materials

- Steel and malleable iron

Standard Finishes

- Malleable iron and steel parts: zinc electroplate and clear chromate

NEC/CEC Certifications and Compliances

- CSA Certified: 065180
- UL Listed: E2527
- UL Standard: 514A



8438R



8458R

Illustrated Features



Ball Type Swivel Fixture Hanger Covers shown with octagonal and with square stamped steel outlet boxes.

	Fixture Stem Size (Inches)	Length A mm (in)	Support Weight kg (lbs)	Catalog Number
SHC Ball Type Swivel Hanger Covers — Permit 20° swing from vertical				
For 3-1/4" and 4" Octagonal Boxes				
	1/2	44.5 (1.75)	22.5 (50)	8438R
	3/4	50.8 (2.00)	22.5 (50)	8436R
For 4" Square Boxes				
	1/2	44.5 (1.75)	22.5 (50)	8458R
	3/4	50.8 (2.00)	22.5 (50)	8456R

POLES/HANGERS: NEC/CEC ORDINARY LOCATION FLEXIBLE FIXTURE HANGERS



EF and FHS Series Flexible Fixture Hangers

Hook and Loop

UNILETS® for Use with Threaded Rigid Metal Conduit and IMC.

CEC:
Listed for Ordinary (Unclassified) Locations

Applications

- Designed for suspension of HID, fluorescent and incandescent lighting fixtures.

Features

- Protect fixture against wind and vibration damage.
- Cushion type for added protection where lighting fixtures are subjected to vibration.
- EF hook and loop hangers
 - Malleable iron for strength and safety.
 - Hook and loop combination permits quick disconnect and removal of fixture for maintenance.
 - Offer inexpensive means of pendant flexible suspension of lighting fixtures.
 - Permit free swing in any direction.
 - EF jaw openings can be completely closed for added safety.
- FHS support hangers
 - Provide up to 158.8 kg (350 lbs) support for fluorescent fixtures on the non-electrical side of mounting.
 - Straddle a maximum of 1-1/4" conduit and take 1/2" or 3/4" fixture hook or conduit.

Standard Materials

- Malleable iron



EFHM



EFHF



FHS

Standard Finishes

- Zinc electroplate and clear chromate

CEC Certifications and Compliances

- CSA Certified: 065180

POLES/HANGERS: NEC/CEC ORDINARY LOCATION FLEXIBLE FIXTURE HANGERS

	Size (Inches)	Length A mm (in)	Support Weight kg (lbs)	Catalog Number
EF – Safety Support Hooks – With 3/8" jaw opening				
EFHM – Male				
	1/2	66.8 (2.63)	90.0 (200)	EFHM-50
	3/4	74.7 (2.94)		EFHM-75
EFHF – Female				
	1/2	50.8 (2.00)	90.0 (200)	EFHF-50
	3/4	52.1 (2.05)		EFHF-75

FHS – Support for Fixtures, Dummy Side – Straddles up to 1-1/4 trade size conduit – 11/32" diameter mounting holes, spaced 3-1/4" apart



1/2 or 3/4	87.1 (3.31)	157.5 (350)	FHS5075
------------	-------------	-------------	----------------

Dimensions in Millimeters (Inches)

	A	B	C	Catalog Number
EFHM – Male				
	1/2-14 NPT	50.8 (2.00)	66.8 (2.63)	EFHM-50
	3/4-14 NPT	54.1 (2.13)	73.2 (2.88)	EFHM-75
EFHF – Female				
	1/2-14 NPT	50.8 (2.00)	N/A	EFHF-50
	3/4-14 NPT	54.1 (2.13)	N/A	EFHF-75

FH and FHSN Series Flexible Fixture Hangers

Hook and Loop

UNILETS® for Use with Threaded Rigid Metal Conduit and IMC.

CEC:

Listed for Ordinary (Unclassified) Locations

Applications

- Designed for suspension of HID, fluorescent and incandescent lighting fixtures.

Features

- Protect fixture against wind and vibration damage.
- Cushion type for added protection where lighting fixtures are subjected to vibration.
- Malleable iron for strength and safety.
- Hook and loop combination permits quick disconnect and removal of fixture for maintenance.
- Offer inexpensive means of pendant flexible suspension of lighting fixtures.
- Permit free swing in any direction.
- EF and FHSN jaw openings can be completely closed for added safety.

Standard Materials

- Malleable iron

Standard Finishes

- Zinc electroplate and clear chromate

CEC Certifications and Compliances

- CSA Certified: 065180



FHLM



FHMM



FHSN

Illustrated Features



POLES/HANGERS: NEC/CEC ORDINARY LOCATION FLEXIBLE FIXTURE HANGERS







FH and FHSN Series Flexible Fixture Hangers

Hook and Loop

UNILETS® for Use with Threaded Rigid Metal Conduit and IMC.

CEC:
Listed for Ordinary (Unclassified) Locations

POLES/HANGERS: NEC/CEC ORDINARY LOCATION FLEXIBLE FIXTURE HANGERS

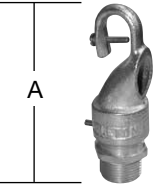
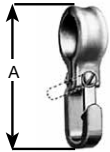
	Size (Inches)	Length A (mm) in	Support Weight kg (lbs)	Catalog Number
FH – Hanger Loops – With 5/8" diameter wireway				
 <p>FHLM</p>	FHLM – Male		157.5 (350)	FHLM-50
	1/2	98.6 (3.88)		
	3/4	104.9 (4.13)		FHLM-75
	FHLF – Female			157.5 (350)
1/2	82.6 (3.25)			
 <p>FHLF</p>	3/4	82.6 (3.25)	FHLF-75	
FH – Hanger Hooks – With 5/8" diameter wireway, 3/8" jaw opening				
 <p>FHHM</p>	FHHM – Male		90.0 (200)	FHHM-50
	1/2	98.6 (3.88)		
	3/4	104.9 (4.13)		FHHM-75
	FHHF – Female			90.0 (200)
1/2	82.6 (3.25)			
 <p>FHHF</p>	3/4	82.6 (3.25)	FHHF-75	
FHHCG – Gasketed Fixture Hanger Hook – With 5/8" wire opening, 3/8" jaw opening, safety screw – As FHHM's above, with internal grommet to prevent moisture and dirt entry				
	FHHCG – Male		34.0 (75)	FHHCG-3750-SS
	1/2	108.0 (4.25)		
	3/4	108.0 (4.25)		FHHCG-3775-SS
FHSN – Conduit Suspension Hanger – With safety strap—clamps around rigid conduit or IMC –Has 3/8" jaw opening				
	1/2	79.5 (3.13)	67.5 (150)	FHSN-50
	3/4	82.6 (3.25)		FHSN-75
	1	85.9 (3.38)		FHSN-100

GHPH Power Hook for Industrial High Bay Luminaire

Receptacle and Hook and Loop

UNILETS® for Use with Threaded Rigid Metal Conduit and IMC.

NEC/CEC:

Listed for Ordinary (Unclassified) Locations

Applications

- Designed for suspension of HID, fluorescent and incandescent lighting fixtures.

Features

- Permit quick disconnect and removal of fixture for maintenance.
- Available in pendant or feed-thru.
- Available with matching cord set.

Standard Materials

- Malleable iron with steel cover
- Screws: stainless steel

Standard Finishes

- Malleable iron parts: triple-coat—(1) zinc electroplate, (2) chromate, and (3) epoxy powder coat
- Steel parts: zinc electroplate

NEC/CEC Certifications and Compliances

- UL Standard: UL 57
- CSA Standard: C22.2 No. 9, C22.2 No. 250
- CSA Certified: 009349

GHPHP and GHPHT — Receptacle Hangers



GHPHP



GHPHT

		Conduit Hub Size (Inches)	Voltage	Hubbell Plug	Catalog Number	
					Pendant	Feed-Thru
Furnished with assembled FS box, EFHM, safety lock, receptacle, and steel cover. Supports 90.7kg (200 lbs).						
<p>215.9 (8.5) 153.9 (6.06)</p>	GHPHP	3/4	120	L5-15P	GHPHP12	GHPHT12
	GHPHT	3/4	208, 240	L6-15P	GHPHP24	GHPHT24
		3/4	277	L7-15P	GHPHP27	GHPHT27
		3/4	347	L37-20P	GHPHP34 ①	GHPHT34 ①
		3/4	480	L8-20P	GHPHP48	GHPHT48
		3/4	600	L9-20P	GHPHP60 ①	GHPHT60 ①

Cord Sets — With Loop — Supplied with 600 V, 90°C 3 conductor No. 16 SOW cable, locking plug and 3/4" FHLM loop

		Voltage	Amperes	0.6 m (2' ft) Cord	0.9 m (3 ft) Cord	1.21 m (4 ft) Cord
		120	15	G-HCPL-2-12	G-HCPL-3-12	G-HCPL-4-12
		208, 240	15	G-HCPL-2-24	G-HCPL-3-24	G-HCPL-4-24
		277	15	G-HCPL-2-27	G-HCPL-3-27	G-HCPL-4-27
		347	20	G-HCPL-2-34 ①	G-HCPL-3-34 ①	G-HCPL-4-34 ①
		480	20	G-HCPL-2-48	G-HCPL-3-48	G-HCPL-4-48
		600	20	G-HCPL-2-60 ①	G-HCPL-3-60 ①	G-HCPL-4-60 ①

Fuse and Cartridge — Cartridges are furnished complete with two 254 mm (10") long high temperature wire leads and 600 Volt fuse

		Amperes	Catalog Number
		6	G-F6
		10	G-F10
		20	G-F20
		30	G-F30

① Certified to meet the Canadian Electrical Code (CEC) only.

Power Hook for Industrial High Bay Luminaires

Furnished with Receptacle, Plug, 18" 16-3 SO Cord and Loop Fixture Hanger

CEC:
Listed for Ordinary (Unclassified) Locations

Applications

- Designed for suspension of HID, fluorescent and incandescent lighting fixtures.

Features

- All hangers
 - All fixture hangers protect fixture against wind and vibration damage.
 - Cushion type for added protection where lighting fixtures are subjected to vibration.
- G-HBPH power hook for industrial luminaires
 - Loop that suspends fixture cannot be removed until plug is disconnected from power receptacle.
 - 20 Amp plug, receptacle and cable are provided in all voltages.
 - Rotating plug after insertion locks plug in receptacle, eliminating plug fall-out.
 - Loop and hook provide flexible mounting, ideal in areas where vibration is encountered.

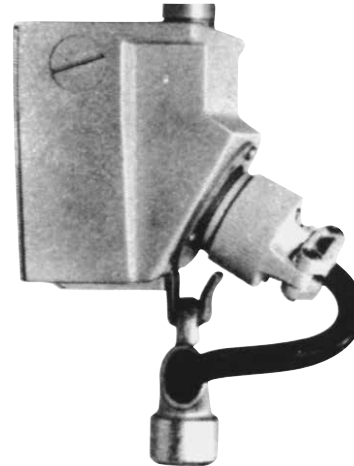

Standard Materials

- Copperfree (4/10 of 1% max.) cast aluminum







Standard Finishes

- Powder coat epoxy

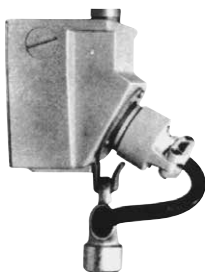
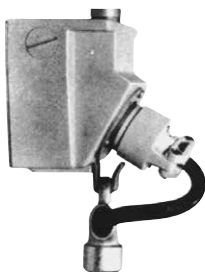
CEC Certifications and Compliances

- CSA Standard: C22.2 No. 9, C22.2 No. 250
- CSA Certified: 009349

POLES/HANGERS: NEC/CEC ORDINARY LOCATION FLEXIBLE FIXTURE HANGERS

	Size (Inches)	Voltage	Catalog Number
	3/4	120	G-HBPH-120
	3/4	208	G-HBPH-208
	3/4	240	G-HBPH-240
	3/4	277	G-HBPH-277
	3/4	347	G-HBPH-347
	3/4	480	G-HBPH-480
	3/4	600	G-HBPH-600

Appleton

Round Tapered Steel Poles

NEC/CEC:
Rated for Ordinary (Unclassified) Locations

Applications

- To mount single or multiple luminaires to heights from 6.1 to 11.9 m (20 to 39 ft).

Features

- 50.8 mm (2 in) pipe size tenon accepts a single luminaire, or 2, 3, or 4 luminaires with appropriate pole-top mounting bracket.
- Shafts are tapered, one-section design of 11 gauge commercial quality steel with a minimum yield strength of 55,000 psi after fabrication.
- Base plates are of structural quality hot-rolled steel with guaranteed minimum yield strength of 36,000 psi.
- A 101.6 x 165.1 mm (4 in x 6-1/2 in) reinforced handhole with cover and grounding lug 55.6 mm (14 in) above the pole base is standard.
- Anchor bolts are furnished complete with nuts and washers, and are of 55,000 psi steel.

Standard Finishes

- Poles are finished with red-oxide prime-paint after fabrication

Options

- For bronze powder coat finish (to match Appleton fixtures) add Suffix **-EPX**.
- For galvanized finish add **-GAL**.

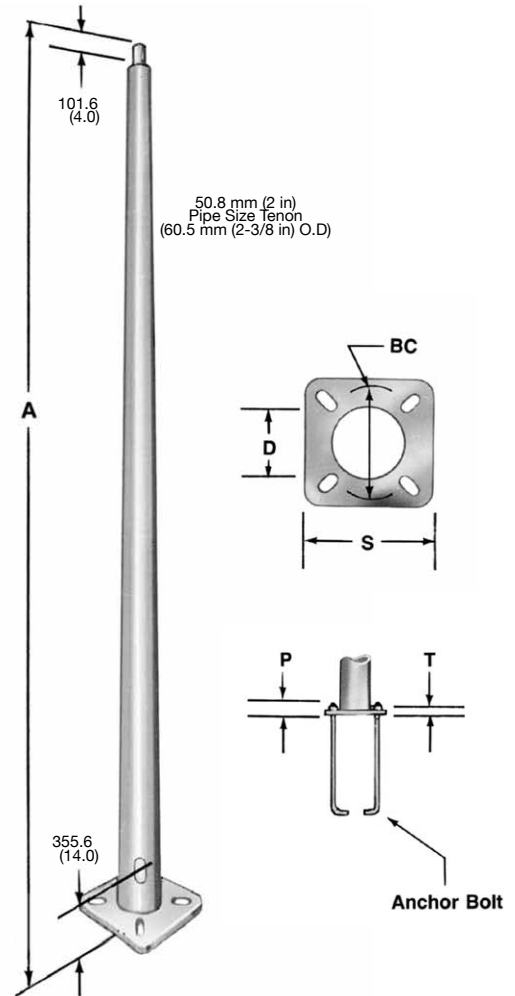

Dimensions may vary. Consult your local sales representative for specifications

Mounting Height m (ft) A	Shaft Size ②	Base Size mm (in) S ①	Bolt Circle mm (in) BC	Base Thickness mm (in) T ①	Bolt Proj. mm (in) P ①	Tube Diameter mm (in) D	Anchor Bolt Dia. x Lgth. mm (in)	Max. Proj Area Sq.M (Sq. Ft) ③	Catalog Number ④
6.1 (20)	165.1 x 94.0 x 6.1 (6.5 x 3.7 x 20')	254.0 (10.0)	①	25.4 (1.0)	57.2 (2.25)	165.1 (6.5)	25.4 x 1016 (1 x 40)	1.74 (18.7)	G-PRTH-20
7.6 (25)	177.8 x 88.9 x 7.6 (7.0 x 3.5 x 25')	266.7 (10.5)	①	25.4 (1.0)	57.2 (2.25)	177.8 (7.0)	25.4 x 1016 (1 x 40)	1.34 (14.4)	G-PRTH-25
9.1 (30)	203.2 x 96.5 x 9.1 (8.0 x 3.8 x 30')	292.1 (11.5)	①	25.4 (1.0)	57.2 (2.25)	203.2 (8.0)	25.4 x 1016 (1 x 40)	1.35 (14.5)	G-PRTH-30
10.7 (35)	215.9 x 91.4 x 10.7 (8.5 x 3.6 x 35')	304.8 (12.0)	①	25.4 (1.0)	57.2 (2.25)	215.9 (8.5)	25.4 x 1016 (1 x 40)	1.17 (12.6)	G-PRTH-35
11.9 (39)	228.6 x 88.9 x 11.9 (9.0 x 3.5 x 39')	330.2 (13.0)	①	25.4 (1.0)	57.2 (2.25)	228.6 (9.0)	25.4 x 1016 (1 x 40)	1.09 (11.7)	G-PRTH-39

① Dimensions may vary—Consult your local sales representative for specifications.

② Shaft bottom [MM. Dia. (In. Dia.)] x shaft top [MM. Dia. (In. Dia.)] x shaft length to tenon.

③ Calculated for winds of 160 KPH/100 MPH.

④ Anchor bolts and templates are preshipped upon request.

Hinged Steel Poles

NEC/CEC:
Rated for Ordinary (Unclassified) Locations

Applications

- To mount single or multiple luminaires to heights from 6.1 to 9.1 m (20 to 35 ft). Hinged design allows easy servicing of luminaires at shoulder height.

Features

- Shafts are structural steel with a minimum yield strength of 46,000 psi.
- Heavy duty hinge assembly secures upper section to lower section with high strength 19.05 mm (3/4 in) Dia. bolt. A flexible protective channel is provided to protect wires when pole is lowered.
- Pole counter-balance is designed to offset weight of luminaires and is made from steel with minimum yield strength of 36,000 psi.
- Base plates are of structural quality hot-rolled steel with minimum yield strength of 36,000 psi.
- A 76.2 x 127 mm (3 in x 5 in) reinforced handhole with cover and grounding lug 355.6 mm (14 in) above the pole base is standard.
- Anchor bolts are furnished complete with nuts and washers, and are of 50,000 psi steel.

Standard Finishes

- Poles are finished with red-oxide prime-paint after fabrication

Options

- For bronze powder coat finish (to match Appleton fixtures) add suffix **-EPX**. For galvanized finish add **-GAL**.
- An optional lowering winch is available and recommended for easy one-man operation of hinged poles. (Only one lowering winch per installation is required because winch assembly mounts from pole to pole and dismounts for easy storage.) Lowering winch is furnished with mounting hardware, 7.62 m (25 ft) of 4.8 mm (3/16 in) galvanized wire rope and safety snap hook.

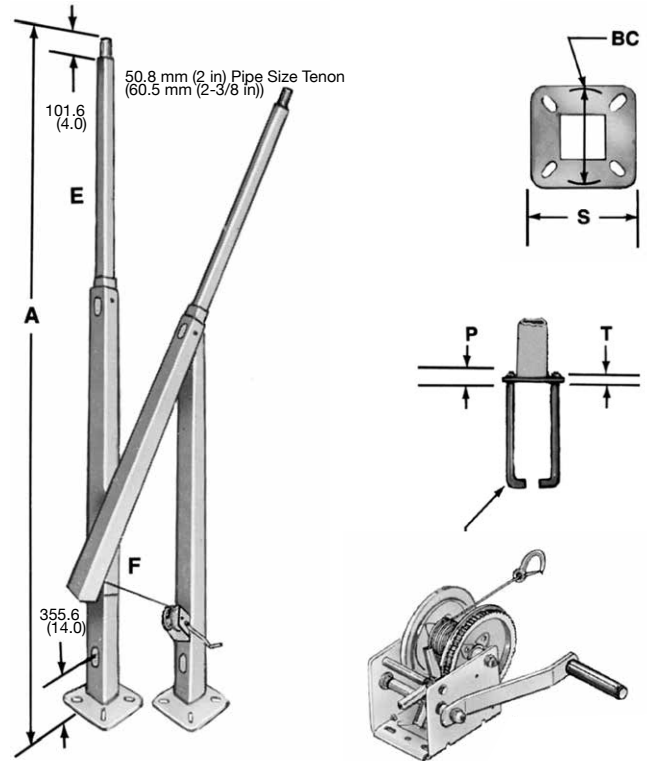

Accessory: GLW – Lowering Device (Winch)

Dimensions may vary. Consult your local sales representative for specifications

Mounting Height m (ft)	Shaft Size Mm.Sq. (in.Sq.) x Ga.		Base Size Mm. Sq (in. Sq) S ①	Bolt Circle mm (in) BC	Base Thickness Mm (in) T	Bolt Proj. Mm (in) P	Anchor Bolt Dia. x Lgth. mm (in)	Max. Proj Area Sq.M. (Sq. Ft.) ③	Loading Weight kg (lbs)	Catalog Number ②
	F	E								
6.1 (20)	2580.6 (4) x 7	2580.6 (4) x 11	6451.6 (10.0)	①	19.1 (0.75)	50.8 (2.0)	19.1 x 711.2 (.75 x 28)	0.86 (9.3)	104.3 (230)	G-PHSM-20
6.1 (20)	3225.8 (5)x 7	3225.8 (5) x 11	7419.3 (11.5)	①	25.4 (1.0)	57.2 (2.25)	25.4 x 1016 (1.0 x 40)	1.4 (15.2)	158.8 (350)	G-PHSH-20
7.32 (24)	2580.6 (4) x 7	2580.6 (4) x 11	6451.6 (10.0)	①	19.1 (0.75)	50.8 (2.0)	19.1 x 711.2 (.75 x 28)	0.57 (6.1)	77.1 (170)	G-PHSM-24
7.32 (24)	3871.0 (6) x 7	3871.0 (6) x 11	7741.9 (12.0)	①	25.4 (1.0)	57.2 (2.25)	25.4 x 1016 (1.0 x 40)	1.33 (14.3)	127.0 (280)	G-PHSH-24
9.14 (30)	2580.6 (4) x 7	2580.6 (4) x 11	6541.6 (10.0)	①	19.1 (0.75)	50.8 (2.0)	19.1 x 711.2 (.75 x 28)	0.27 (2.9)	68.0 (150)	G-PHSM-30
9.14 (30)	3871.0 (6) x 7	3871.0 (6) x 11	7741.9 (12.0)	①	25.4 (1.0)	57.2 (2.25)	25.4 x 1016 (1.0 x 40)	1.00 (10.8)	108.9 (240)	G-PHSH-30
10.67 (35)	3871.0 (6) x 7	3871.0 (6) x 11	7741.9 (12.0)	①	25.4 (1.0)	57.2 (2.25)	25.4 x 1016 (1.0 x 40)	0.33 (3.6)	81.6 (180)	G-PHSH-35

① Dimensions may vary—Consult your local sales representative for specifications.

② Anchor bolts and templates are preshipped upon request. For accessory lowering winch, specify Cat. No. GLW.

③ Calculated for winds of 100 MPH/160 KPH.

Square Tapered Steel Poles

NEC/CEC:
Rated for Ordinary (Unclassified) Locations

Applications

- To mount single or multiple luminaires to heights from 6.1 to 11.9 m (20 to 39 ft).

Features

- 0.61 mm (2 in) pipe size tenon accepts a single luminaire or 2, 3, or 4 luminaires with appropriate pole-top mounting bracket.
- High strength shafts have a uniform taper and are made from 11 gauge commercial quality hot rolled steel.
- Base plates are of structural quality hot rolled steel with minimum yield strength of 36,000 psi.
- A 76.2 x 127 mm (3 in x 5 in) reinforced handhole with cover and grounding lug 355.6 mm (14 in) above the pole base is standard.
- Anchor bolts are furnished complete with nuts and washers, and are of 55,000 psi steel.

Standard Finishes

- Poles are finished with red-oxide prime-paint after fabrication

Options

- For bronze powder coat finish (to match Appleton fixtures) add Suffix **-EPX**. For galvanized finish add suffix **-GAL**.

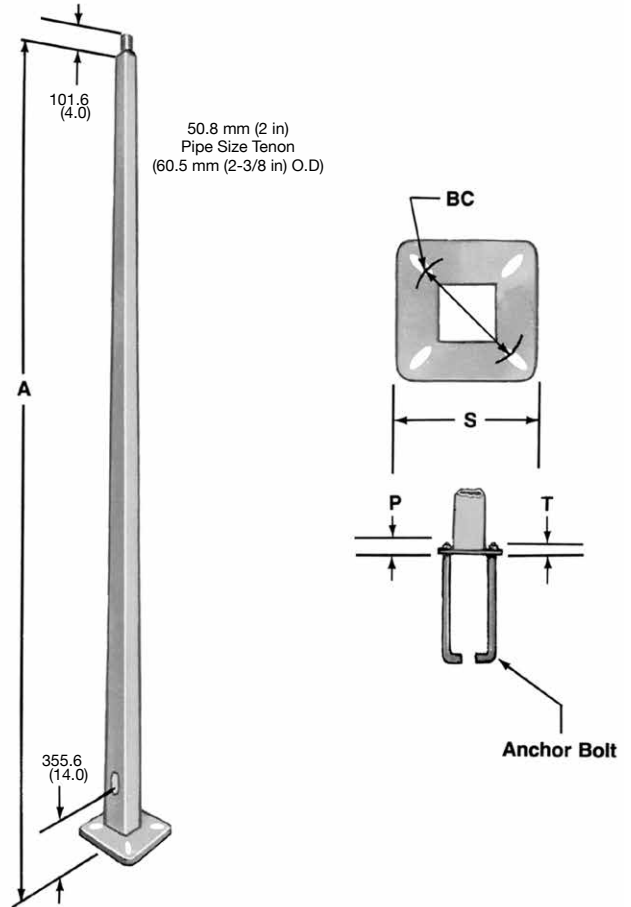

Dimensions may vary. Consult your local sales representative for specifications

Mounting Height m (ft) A	Shaft Size ① Sq.MM. x M (Sq.In. x Ft)	Base Size mm (in) S ②	Bolt Circle mm (in) BC	Base Thickness mm (in) T ②	Bolt Proj. mm (in) P ②	Anchor Bolt Dia. x Lgth. In/mm	Max. Proj Area Sq.M (Sq.Ft) ③	Catalog Number ④
6.1 (20)	3387 x 2097 x 6.1 (5.25 x 3.25 x 20')	266.7 (10.5)	②	25.4 (1.0)	57.2 (2.25)	25.4 x 1016.0 (1 x 40)	0.87 (9.4)	G-PSTH-20
7.3 (24)	4032 x 2484 x 12.2 (6.25 x 3.85 x 24')	330.2 (13.0)	②	25.4 (1.0)	57.2 (2.25)	25.4 x 1016.0 (1 x 40)	0.83 (8.9)	G-PSTH-24
9.1 (30)	4290 x 2097 x 9.1 (6.65 x 3.25 x 30')	304.8 (12.0)	②	25.4 (1.0)	57.2 (2.25)	25.4 x 1016.0 (1 x 40)	0.54 (5.8)	G-PSTH-30
10.7 (35)	4032 x 2097 x 10.7 (6.25 x 3.25 x 35')	330.2 (13.0)	②	25.4 (1.0)	57.2 (2.25)	25.4 x 1016.0 (1 x 40)	0.41 (4.4)	G-PSTH-35
11.9 (39)	4613 x 2097 x 11.9 (7.15 x 3.25 x 39')	330.2 (13.0)	②	25.4 (1.0)	63.5 (2.50)	25.4 x 1016.0 (1 x 40)	0.35 (3.8)	G-PSTH-39

① Shaft bottom [MM. Dia.(In. Dia)] x shaft top [MM. Dia.(In. Dia)] x shaft length to tenon.

② Dimensions may vary—Consult your local sales representative for specifications.

③ Calculated for winds of 100 MPH.

④ Anchor bolts and templates are preshipped upon request.

Square Steel Poles

NEC/CEC:
Rated for Ordinary (Unclassified) Locations

Applications

- To mount single or multiple luminaires to heights from 4.3 to 9.1 m (14 to 30 ft).

Features

- 50.8 mm (2 in) pipe size tenon accepts a single luminaire, or 2, 3, or 4 luminaires with appropriate pole-top mounting bracket.
- High strength shafts are made from square steel structural tube with minimum yield strength of 46,000 psi.
- Base plates are of structural quality hot-rolled steel with minimum yield strength of 36,000 psi.
- A 76.2 x 127 mm (3 in x 5 in) reinforced handhole with cover and grounding lug 355.6 mm (14 in) above the pole base is standard.
- Anchor bolts are furnished complete with nuts and washers, and are of 55,000 psi steel.

Standard Finishes

- Poles are finished with red-oxide prime-paint after fabrication

Options

- For bronze powder coat finish (to match Appleton fixtures) add Suffix **-EPX**. For galvanized finish add suffix **-GAL**.

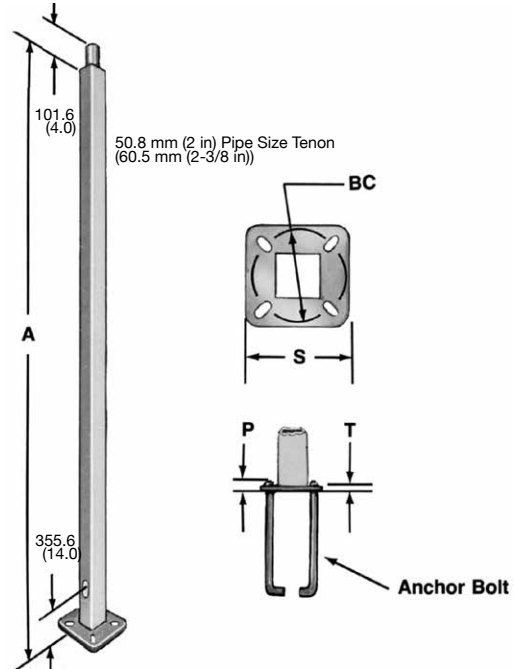

Dimensions may vary. Consult your local sales representative for specifications

Mounting Height m (ft) A	Shaft Size ① mm (in)	Base Size mm (in) S ②	Bolt Circle mm (in) BC	Base Thickness mm (in) T ②	Bolt Proj. in (mm) P ②	Anchor Bolt Dia. x Lgth. mm (in)	Max. Proj Area Sq.M. (Sq.Ft.) ③	Catalog Number ④
4.3 (14)	101.6 x 101.6 x 11Ga. (4" x 4" x 11Ga.)	203.2 (8.0)	②	19.1 (0.75)	50.8 (2.00)	19.1 x 508.0 (0.75 x 20)	1.01 (10.9)	G-PSSM-14
4.3 (14)	101.6 x 101.6 x 7Ga. (4" x 4" x 7Ga.)	203.2 (8.0)	②	19.1 (0.75)	50.8 (2.00)	19.1 x 508.0 (0.75 x 20)	1.34 (14.4)	G-PSSH-14
5.2 (17)	101.6 x 101.6 x 11Ga. (4" x 4" x 11Ga.)	203.2 (8.0)	②	19.1 (0.75)	50.8 (2.00)	19.1 x 508.0 (0.75 x 20)	0.64 (6.9)	G-PSSM-17
5.2 (17)	101.6 x 101.6 x 7Ga. (4" x 4" x 7Ga.)	203.2 (8.0)	②	19.1 (0.75)	50.8 (2.00)	19.1 x 508.0 (0.75 x 20)	1.11 (11.9)	G-PSSH-17
6.1 (20)	101.6 x 101.6 x 7Ga. (4" x 4" x 7Ga.)	203.2 (8.0)	②	19.1 (0.75)	50.8 (2.00)	19.1 x 508.0 (0.75 x 20)	0.94 (10.1)	G-PSSM-20
6.1 (20)	127.0 x 127.0 x 7Ga. (5" x 5" x 7Ga.)	279.4 (11)	②	25.4 (1.0)	57.2 (2.25)	25.4 x 1016 (1 x 40)	1.60 (17.2)	G-PSSH-20
7.3 (24)	127.0 x 127.0 x 11Ga. (5" x 5" x 7Ga.)	279.4 (11)	②	25.4 (1.0)	57.2 (2.25)	25.4 x 1016 (1 x 40)	1.11 (11.9)	G-PSSM-24
7.3 (24)	152.4 x 152.4 x 7Ga. (6" x 6" x 7Ga.)	304.8 (12.0)	②	25.4 (1.0)	57.2 (2.25)	25.4 x 1016 (1 x 40)	1.75 (18.8)	G-PSSH-24
9.1 (30)	127.0 x 127.0 x 7Ga. (5" x 5" x 7Ga.)	279.4 (11)	②	25.4 (1.0)	57.2 (2.25)	25.4 x 1016 (1 x 40)	0.64 (6.9)	G-PSSM-30
9.1 (30)	152.4 x 152.4 x 7Ga. (6" x 6" x 7Ga.)	304.8 (12.0)	②	25.4 (1.0)	57.2 (2.25)	25.4 x 1016 (1 x 40)	1.09 (11.7)	G-PSSH-30

① Shaft bottom [MM. Dia.(In. Dia)] x shaft top [MM. Dia.(In. Dia)] x shaft length to tenon.

② Dimensions may vary—Consult your local sales representative for specifications.

③ Calculated for winds of 100 MPH.

④ Anchor bolts and templates are preshipped upon request.

Floodlight Mounting Brackets

Single or Multiple Installation on Wall, Wood or Metal Poles

NEC/CEC:
Rated for Ordinary (Unclassified) Locations

Metal Pole Brackets

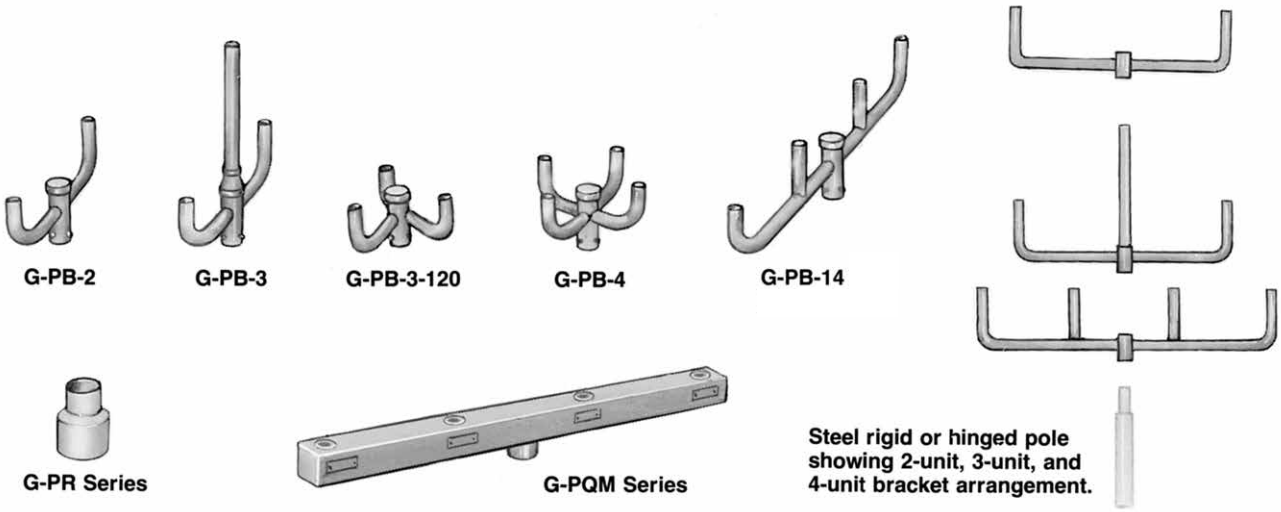

Wood Pole Brackets

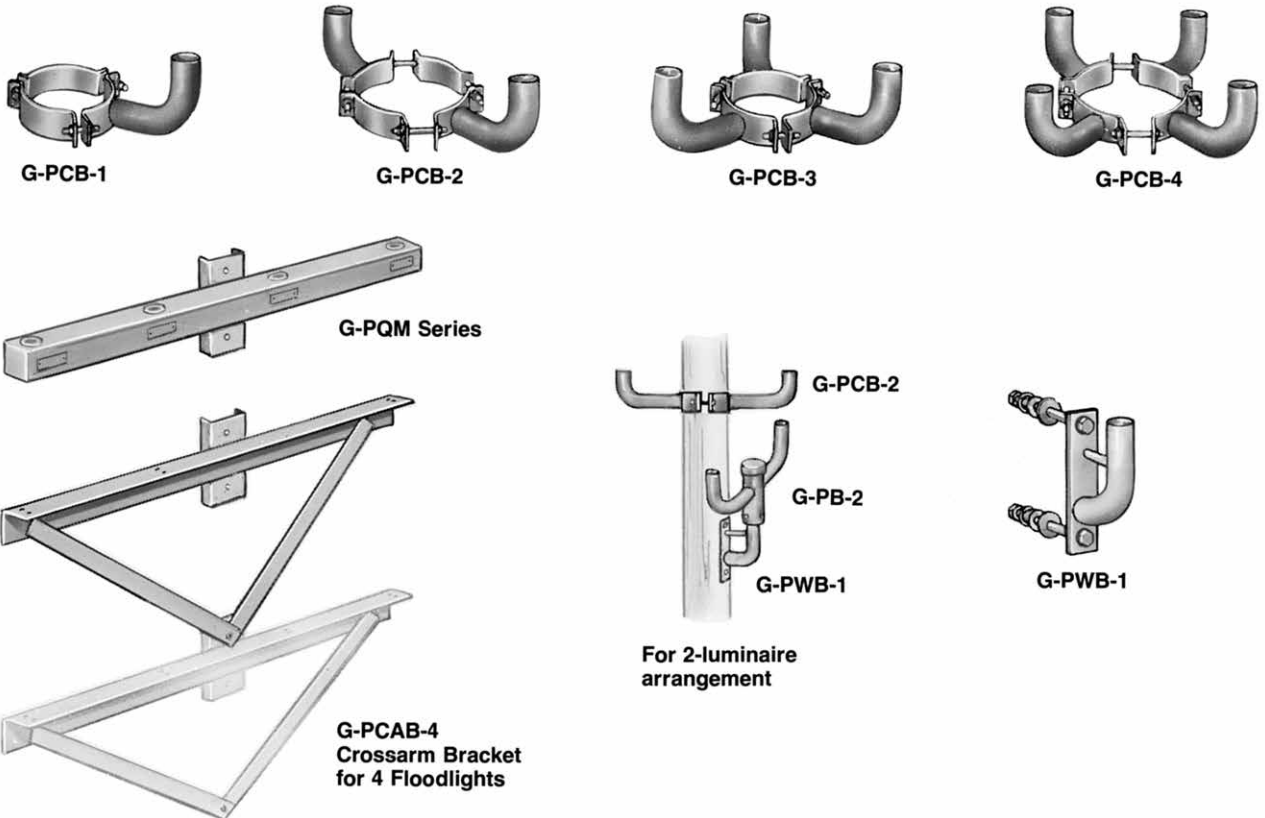

Floodlight Mounting Brackets

Single or Multiple Installation on Wall, Wood or Metal Poles

NEC/CEC:
 Rated for Ordinary (Unclassified) Locations

Poletop Brackets for Metal Poles — Dimensions may vary. Consult your local sales representative for specifications
 Floodlight mounting brackets for installation of 2 to 4 floodlights atop metal poles are manufactured from high-strength steel tube, and slip-fit onto 50.8 mm (2 in) pipe size poletop tenons. Furnished with 3 locking setscrews and red oxide prime coat finish. Bracket tenon is 50.8 mm (2 in) pipe size (60.5 mm 2-3/8 in) O.D.).

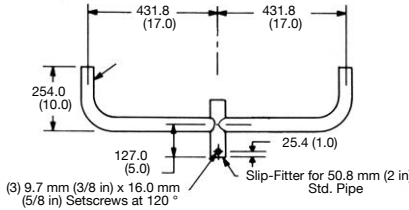
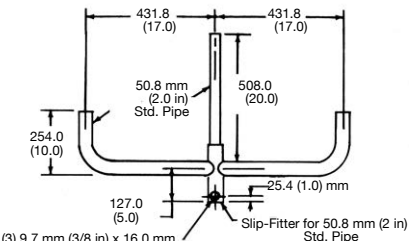
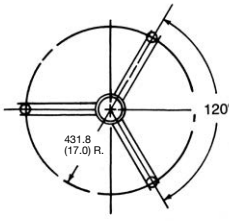
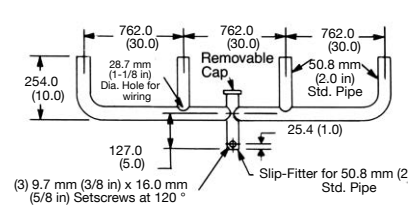
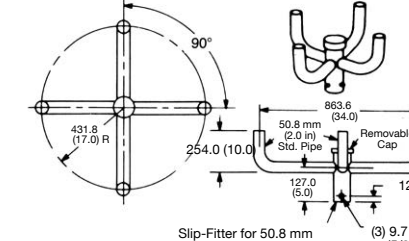
Dimensions mm (in)	Description	Catalog Number
 <p>Diagram showing a U-shaped bracket with two mounting arms. Dimensions: 431.8 (17.0) mm between mounting holes, 254.0 (10.0) mm height. Mounting holes are 127.0 (5.0) mm from the center. Slip-fitter for 50.8 mm (2 in) Std. Pipe. (3) 9.7 mm (3/8 in) x 16.0 mm (5/8 in) Setscrews at 120°.</p>	Poletop Bracket for Two Luminaires	G-PB-2
 <p>Diagram showing a U-shaped bracket with three mounting arms. Dimensions: 431.8 (17.0) mm between mounting holes, 254.0 (10.0) mm height. Mounting holes are 127.0 (5.0) mm from the center. Slip-fitter for 50.8 mm (2 in) Std. Pipe. (3) 9.7 mm (3/8 in) x 16.0 mm (5/8 in) Setscrews at 120°.</p>	Poletop Bracket for Three Luminaires	G-PB-3
 <p>Diagram showing a circular arrangement of three mounting arms at 120° apart. Radius is 431.8 (17.0) R.</p>	Poletop Bracket for Three Luminaires (120° apart)	G-PB-3-120
 <p>Diagram showing a U-shaped bracket with four mounting arms in a line. Dimensions: 762.0 (30.0) mm between mounting holes, 254.0 (10.0) mm height. Mounting holes are 127.0 (5.0) mm from the center. Slip-fitter for 50.8 mm (2 in) Std. Pipe. (3) 9.7 mm (3/8 in) x 16.0 mm (5/8 in) Setscrews at 120°. Includes a Removable Cap and a 28.7 mm (1-1/8 in) Dia. Hole for wiring.</p>	Poletop Bracket for Four Luminaires (in line)	G-PB-14
 <p>Diagram showing a cross-shaped bracket with four mounting arms. Dimensions: 431.8 (17.0) R for the cross arms, 863.6 (34.0) mm between mounting holes, 254.0 (10.0) mm height. Mounting holes are 127.0 (5.0) mm from the center. Slip-fitter for 50.8 mm (2 in) Std. Pipe. (3) 9.7 mm (3/8 in) x 16.0 mm (5/8 in) Setscrews at 120°. Includes a Removable Cap.</p>	Poletop Bracket for Four Luminaires	G-PB-4

Floodlight Mounting Brackets

Single or Multiple Installation on Wall, Wood or Metal Poles

NEC/CEC:
Rated for Ordinary (Unclassified) Locations

Poletop Reducers

Made from high strength steel tubing, complete with 3 locking setscrews and with red-oxide prime finish.

Poletop Pipe Size Reduction mm (in)	Catalog Number
63.5 to 50.8 (2-1/2 to 2)	G-PR-2-1/2
76.2 to 50.8 (3 to 2)	G-PR-3
88.9 to 50.8 (3-1/2 to 2)	G-PR-3-1/2
101.6 to 50.8 (4 to 2)	G-PR-4
127 to 50.8 (5 to 2)	G-PR-5

Dimensions in Millimeters (Inches) — May vary. Consult your local sales representative for specifications

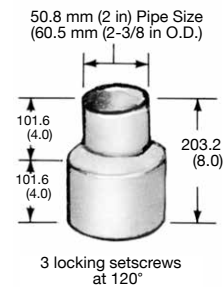

Lite Mount Bars for 4, 8, or 12 Quartzlite or Areamaster Jr. Floodlights

Bars have 11 gauge steel body and 12 gauge steel cover. Two styles: to mount on 50.8 mm (2 in) pipe size poletop tenon, or on wood poles using thru-bolts. Welded construction, with 19.1 mm (3/4 in) N.P.S. tapped hubs. Rain-tight, with red-oxide prime finish.

Number of Fixtures	Length A	Dim. B	Dim C	Dim. D
4	28	—	25	1-1/2
8	60	17	24-1/2	1-1/4
12	96	17	25	1-1/2

Dimensions in Millimeters (Inches) — May vary. Consult your local sales representative for specifications

Dimensions For Mounting Quartzlites or Areamaster Jr.

Number of Fixtures For Mounting	Catalog Number	
	Metal Pole	Wood Pole
4 Fixtures	G-PQM-4T	G-PQM-4W
8 Fixtures	G-PQM-8T	G-PQM-8W
12 Fixtures	G-PQM-12T	G-PQM-12W

For Metal Poles

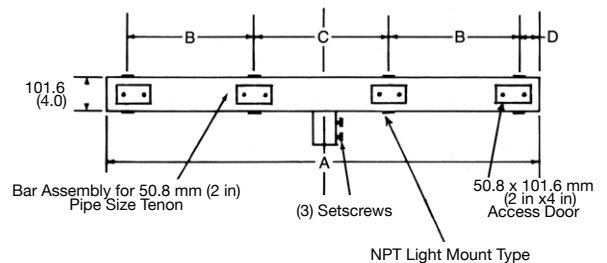

For Wood Poles

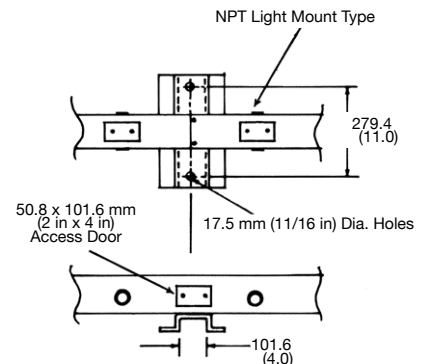

Floodlight Mounting Brackets

Single or Multiple Installation on Wall, Wood or Metal Poles

NEC/CEC:
Rated for Ordinary (Unclassified) Locations

Dimensions may vary. Consult your local sales representative for specifications

	Description	Catalog Number
--	-------------	----------------

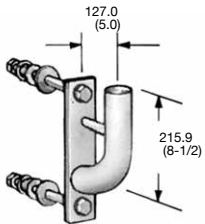

Wood Pole or Wall Mounting Bracket
For Floodlights with 50.8 mm (2 in) Slip-Fitter, or will mount G-PB Series brackets with floodlights.

- Complete with two 330.2 mm (13 in) -long bolts, washers, and nuts.
- Red oxide prime coat finish.

G-PWB-1

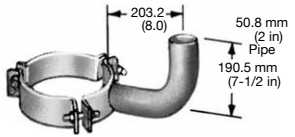

G-PCB-1

Wood Pole Clamp Brackets

- Pole clamping floodlight mounting brackets constructed of 50.8 mm (2 in) steel pipe.
- Furnished complete with clamping bolts and nuts.
- Has red oxide primer coat finish.
- For 1 and 3 floodlights—Fits 152.4 mm (6 in) to 228.6 mm (9 in) poles.
- For 2 and 4 floodlights—Fits 228.6 mm (9 in) to 304.8 mm (12 in) poles.



G-PCB-2

1 Arm

G-PCB-1



G-PCB-3

2 Arm

G-PCB-2

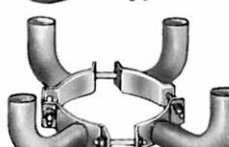

G-PCB-4

3 Arm

G-PCB-3

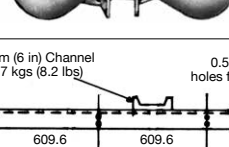

G-PCB-4

4 Arm

G-PCB-4

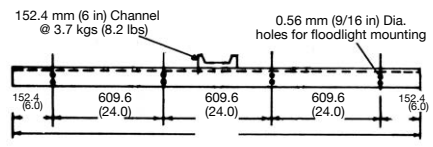

Wood Pole Crossarm Lite Mount Bracket
Mounting arm made of rugged angular steel stock with 1/4" supporting struts. Has hot-dipped galvanized finish. Furnished with all nuts and bolts to assemble and install bracket to wood pole.

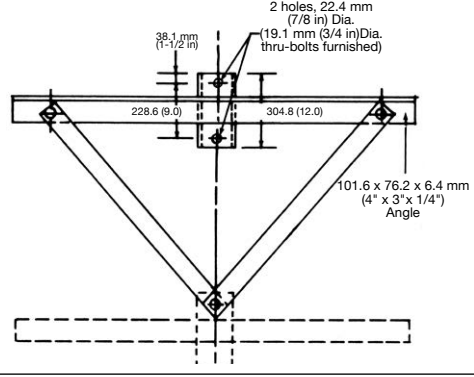

4-Lite

G-PCAB-4

McGill™ HID Temporary Lighting

Designed and Packaged for Quick Installation

NEC:
Listed for Ordinary (Unclassified) Locations

Applications

- More and more contractors are using temporary HID fixtures to light their work sites. Instead of modifying Low-Bay fixtures for this application, McGill's HID Temporary Lighting allows them to buy something faster and easier.

Features

- 400 W Pulse Start Metal Halide lamp provides over 6' candles of illumination at a 6.1 m (20 ft) mounting height.
- McGill offers lighting layouts to conform with OSHA requirements for light output.
- Type "O" lamp and mogul socket complies with NEC 2008 Section 410.130(F)(5) and ANSI C78.387.
- Quick-attach durable 254 mm (10 in) welded wire guard mounts directly to the body to protect lamp and lampholder from accidental impact.
- Fixture is factory wired at 120 Volt, but can be rewired internally for other voltage settings.
- 0.9 meter (3 ft) cord with 5-15P molded plug on end.
- Compact size for easy handling.
- Low-profile fixture design keeps it up and out of the way of activity below.
- High light output and long lamp life.
- Open-air ballast for cooler operation.
- Hook with locking feature.
- (2) 19.1 mm (3/4 in) knock-outs for conduit access.
- Single durable package design makes it easier for distributors to stock and more organized for contractors on the job site.
- Quick and easy to assemble.
- Optional bottom trap available.
- Voltage: 120 V maximum.

Standard Materials

- Enclosure: Heavy-duty steel with powder coated finish
- Lamp: 400 Watt Pulse Start Metal Halide: O-Type, BT37 Clear, EX39 (Exclusionary Mogul Base)
- Multi-Tap ballast: 120, 208, 240, 277 Volt; Factory wired at 120 Volt
- Power cord: 0.9 meter (3 ft), 18/3 SJTW, 120 Volt, 15 Amp cord complete with NEMA 5-15 molded plug
- Lamp guard: 11 ga. white painted steel
- Mounting hook: 11 ga. steel

NEC Certifications and Compliances

- UL and cUL Listed: E196293
- UL Standard: UL 1598
- Suitable for damp locations

Options

- Optional bottom trap available

	Catalog Number
400 W Fixture with Guard	TL40PMT0
Bottom Guard Trap	TLTRAPW
Replacement Lamp Guard	TLGUARDW
Replacement Lamp: 400 W PSMH, O-Type, BT37 Clear, EX39	GMP400BUPS



Shown with optional bottom trap

Illustrated Feature

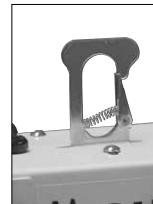

Spring-lock hook allows contractors to mount the unit in seconds, without the need for tools.

Dimensions in Millimeters (Inches)

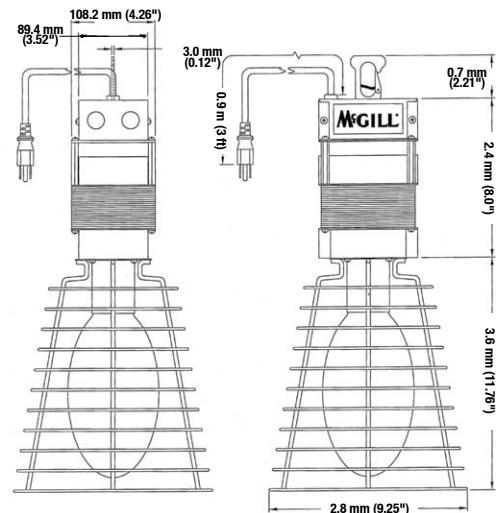

McGill™ String-O-Lights

Low Cost Temporary Lighting

NEC/CEC:
Rated for Ordinary (Unclassified) Locations

Applications

- McGill offers flatwire style for temporary job site lighting systems.

Features

- They are available in 15.2 to 61 m (50 to 200 ft) lengths of 2- and 14 gauge wire with 5 to 10 cage/socket assemblies.
- Brass sockets are enclosed in weather-resistant molded PVC, and plastic connectors provide greater reliability.
- Packaging provides tangle-free, on-the-job handling and installation.
- Easy-open cages snap open and closed for faster installation without tools and easy lamp replacements.
- Non-corrosive cages are fastened to sockets by a non-corrosive collar and accommodate up to 200 Watt bulbs.
- Cable styles meet NEC requirements.
- Convenient, economical temporary lighting.
- 30.5 m (110 ft) messenger wire available to support string where needed.
- Fully assembled; ready for installation.
- Weather-resistant sockets.
- All parts sold separately.

Standard Materials

- Cages: yellow plastic

Note: Not for use with Rough Service Lamps



Flat Wire Cable Style

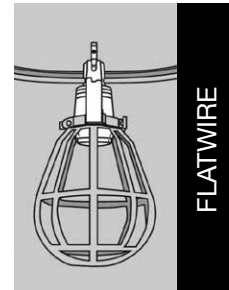

Illustrated Features



Easy-Open Cages



Packaging

McGill™ String-O-Lights

Low Cost Temporary Lighting

NEC/CEC:
Rated for Ordinary (Unclassified) Locations

	Length m (ft)	No. of Cages/ Sockets	Socket Spacing m (ft)	Catalog Number for A-23 Bulb
Flat Wire Styles				
14/2 Flat wire cable	30.5 (100)	10	3.0 (10)	2252-0035
14/2 Flat wire cable	15.2 (50)	5	3.0 (10)	2252-0038
14/2 Flat wire cable	61.0 (200)	10	6.1 (20)	2252-0043
Flat Wire Styles with Plug				
14/2 Flat wire cable with 1-15P plug on one end	30.5 (100)	10	3.0 (10)	2252-0040
14/2 Flat wire cable with 1-15P plug on one end	15.2 (50)	5	3.0 (10)	2252-0041
14/2 Flat wire cable with 1-15P plug on one end	61.0 (200)	10	6.1 (20)	2252-0044

Accessories and Replacement Parts

	Catalog Number
Hangers (for open conductor styles)	2252-1025

Cages

	Catalog Number	
	for A-23 Bulb	for PS-30 Bulb
For use with McGill String-O-Lights		
Single plastic replacement cage only	MCG2250	—
Single plastic replacement cage with screw collar	2250-S	2255
Single plastic replacement cage with right-hand socket assembly and hanger	2252	2256
Single plastic replacement cage with left-hand socket assembly and hanger	2253	—
Single plastic replacement cage with hanger (no socket)	2254	—
For use with most types of Lampholders ①		
Single plastic cage only	2259	—

Socket/Wire Sets

	Catalog Number
Weather-resistant 600 Watt, 250 Volt, 114.3 mm (4-1/2") leads of 14 gauge wire, vulcanized, pigtail socket; left-hand thread	4018
Messenger wire: 30.5 meters (110 feet) 2.3 mm (3/32") diameter 7 x 7 stranded galvanized aircraft cable	2251

① Not for use with rough service lamps

McGill™ 7000 Series Industrial Extension Lights

Rubber Handle without Receptacle

NEC/CEC:
Listed for Ordinary (Unclassified) Locations

NEC:
Meets OSHA requirements

Features

- 7000 Series extension lights resist damage and deterioration.
- Open-end or NO-ROL closed-end cages of extra-heavy, electrically welded, wire accommodate up to 200 Watt bulbs.
- Ideal for use where safety codes prohibit outlets in handles.
- Easy relamping cage.
- Internal strain relief withstands 9.1 kg (30 lb) pull test.
- All-weather cords with molded plugs.

Standard Materials

- Cage: 10 gauge steel wire
- Cord: thermoplastic
- Handle: yellow, grease-resistant, high quality rubber

NEC/CEC Certification and Compliances ①

- UL Listed (with cord): E59071
- UL Listed (without cord): E59054
- UL Standard: 153
- CSA Certified (with cord): LL89639
- CSA Certified (without cord): LL56247
- CSA Standard: C22.2 No. 12



7000-RIG



7999-RGH

① 100 Watt Maximum for UL Listing and CSA Certification.

McGill™ 7000 Series Industrial Extension Lights

Rubber Handle without Receptacle

NEC/CEC:
Listed for Ordinary (Unclassified) Locations

NEC:
Meets OSHA requirements

	Catalog Numbers		
	with out Cord	with 7.6 m (25') 16/3-SJTW Cord	with 15.2 m (50') 16/3-SJTW Cord
Closed-End Extension Lights			
Handle and cage	7000-G	7025-G	7050-G
Handle and cage with reflector	7000-RG	7025-RG	7050-RG
Insulated cage, reflector (100 Watt max.)	7000-RIG	7025-RIG	7050-RIG
Non-metallic cage, reflector (100 Watt max.)	7999-RGH	7925-RGH	7950-RGH

Replacement Cord Sets		
Cord set with molded plugs	6229-1 ①	6229-2 ①

	Catalog Number ①	
	for 60–100 Watt	for 200 Watt
Open-End Extension Lights (without cord)		
Handle and cage	7001-G	7002-G
Handle and cage with reflector	7001-RG	7002-RG

Accessories and Replacement Parts

	Catalog Number	
	With Out Reflector	With Reflector
Cages		
Closed-end cage for 7000	8171	8170
Open-end cage (100 Watt lamp max.)	8133	8162
Open-end cage (200 Watt lamp max.)	8335-2	8336
Closed-end vinyl insulated cage (100 Watt A-21)	08171	08170
Open-end vinyl insulated cage (100 Watt lamp max.)	—	08162
Open-end vinyl insulated cage (200 Watt lamp max.)	—	08336
Non-metallic cage for 7999	—	8224

	Catalog Number	
	Accessory	With Out Switch
Handles and Sockets		
Handle for 7000, 7001, 7002	—	6403
Handle and socket for 7000, 7001, 7002	—	8959
Socket for 7000, 7001, 7002	—	4015
Grounding clamp	9232	—

① Not UL Listed.

McGill™ 7000 Series Industrial Extension Lights

Rubber Handle without Receptacle

NEC/CEC:
Listed for Ordinary (Unclassified) Locations

NEC:
Meets OSHA requirements

	Catalog Numbers		
	with out Cord	with 7.6 m (25') 16/3-SJTW Cord	with 15.2 m (50') 16/3-SJTW Cord
Closed-End Extension Lights			
Handle and cage	C7000-G	C7025-G	C7050-G
Handle and cage with reflector	C7000-RG	C7025-RG	C7050-RG
Insulated cage, reflector (100 Watt max.)	C7000-RIG	C7025-RIG	C7050-RIG
Non-metallic cage, reflector (100 Watt max.)	C7999-RGH	C7925-RGH	C7950-RGH
Replacement Cord Sets			
Cord set with molded plugs		C6229-1 ①	C6229-2 ①

	Catalog Number ①	
	for 60–100 Watt	for 200 Watt
Open-End Extension Lights (without cord)		
Handle and cage	C7001-G	C7002-G
Handle and cage with reflector	C7001-RG	C7002-RG

Accessories and Replacement Parts

	Catalog Number	
	With Out Reflector	With Reflector
Cages		
Closed-end cage for 7000	8171	8170
Open-end cage (100 Watt lamp max.)	8133	8162
Open-end cage (200 Watt lamp max.)	8335-2	8336
Closed-end vinyl insulated cage (100 Watt A-21)	08171	08170
Open-end vinyl insulated cage (100 Watt lamp max.)	—	08162
Open-end vinyl insulated cage (200 Watt lamp max.)	—	08336
Non-metallic cage for 7999	—	8224

	Catalog Number	
	Accessory	With Out Switch
Handles and Sockets		
Handle for 7000, 7001, 7002	—	6403
Handle and socket for 7000, 7001, 7002	—	8959
Socket for 7000, 7001, 7002	—	4015
Grounding clamp	9232	—

① Not CSA Listed.

McGill™ 7000–38 Series Industrial Extension Lights For PAR-38 Lamps

CEC:
Listed for Ordinary (Unclassified) Locations

Applications

- These extension lights are ideal for temporary flood lighting, railroad car inspections, spot light inspecting of the internal conditions of large well pipes, and other applications requiring intense lighting.

Features

- 7000 Series extension lights resist damage and deterioration.
- Open-end of extra-heavy, electrically welded, wire accommodates up to 200 Watt bulbs.
- Ideal for use where safety codes prohibit outlets in handles.
- Easy relamping cage.
- Internal strain relief withstands 9.1 kg (30 lb) pull test.
- All-weather cords with molded plugs.

Standard Materials

- Cage: 10 gauge steel wire
- Cord: thermoplastic
- Handle: yellow, grease-resistant, high quality rubber

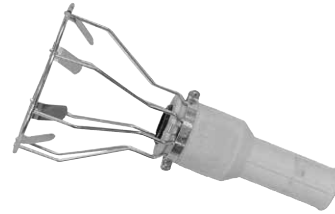

7000–G–38

CEC Certification and Compliances

- CSA Certified (with cord): LL89639
- CSA Certified (without cord): LL56247
- CSA Standard: C22.2 No. 12

	Catalog Number		
	with out Cord	with 7.6 m (25') 6/3–SJTW Cord	with 15.2 m (50') 16/3–SJTW Cord
Handle and cage (100 Watt max. bulb)	7000-G-38	7025-G-38	7050-G-38
Handle and cage (200 Watt bulb)	7000-G-38-200	7025-G-38-200	7050-G-38-200
Handle and cage	C7000-G-38 ①	C7025-G-38 ①	C7050-G-38 ①

Accessories and Replacement Parts

	Catalog Number	
	With Out Reflector	with Trap
Cages		
Cage for 7000-38	1455-38	1455-38-T
		With Out Switch
Handles and Sockets		
Handle for 7000, 7001, 7002		6403
Grounding clamp		8959
	7.6 m (25') 6/3–SJTW Cord	15.2 m (50') 16/3–SJTW Cord
Cord Sets		
Cord set with molded plugs	6229-1	6229-2

① Certified to meet the Canadian Electrical Code (CEC) only.

McGill™ 6000 Series Commercial–Duty Extension Lights

Polypropylene Handle with Receptacle

NEC/CEC:
Listed for Ordinary (Unclassified) Locations

NEC:
Meets OSHA requirements

Features

- Commercial-duty extension lights resist impact, abrasion and oil.
- Three wire grounded handles with convenience receptacle.
- Easy-open, NO-ROL cage with rotating hook saves time and permits precise lamp positioning.
- Plated metal parts resist rust and corrosion.
- All-weather cords have molded plugs.
- 10 Amp, 125 Vac receptacle rating.
- Cage accommodates 100 Watt max. bulbs.
- Push-through switch.
- Accommodates 16/3 cord type only.



6025-SRG

Standard Materials

- Cord: 16/3-SJTW yellow thermoplastic
- Cage: 10 gauge steel

Standard Finish

- Cage: zinc-plated

NEC/CEC Certification and Compliances ①

- UL Listed: E59071
- UL Standard: 153
- CSA Certified: LL89639

	with 0.3 m (1') 16/3-SJTW Cord	Catalog Numbers with 7.6 m (25') 16/3-SJTW Cord	with 15.2 m (50') 16/3-SJTW Cord
Handle and cage with switch and reflector	6012-SRG ②	6025-SRG	6050-SRG
Handle and cage with switch and reflector	C6012-SRG ③④	C6025-SRG ④	C6050-SRG ④
Handle and cage with switch and reflector and GFCI	—	6025-SRG-GFCI	—

① 100 Watt Maximum for UL Listing and CSA Certification.

② UL Listed for cord reel usage only.

③ CSA Listed for cord reel usage only.

④ Certified to meet the Canadian Electrical Code (CEC) only.

McGill™ 5000 Series Industrial Extension Lights

Thermoplastic Handle With or Without Receptacle

NEC/CEC:
Listed for Ordinary (Unclassified) Locations

NEC:
Meets OSHA requirements

Features

- Industrial-duty extension lights resist impact, abrasion and oil.
- Yellow handles with receptacle, yellow cords, and grounded cages enhance safety, while easy-open cages speed relamping.
- All-weather cords have molded plugs for durability.
- Cages feature rotating hooks and NO-ROL design for accurate light positioning.
- Accommodates up to 200 Watt rough service bulbs.
- Meets NEC requirements for power tool grounding.

Standard Materials

- Cords: 16/3-SJTW thermoplastic
- Cages: 10 gauge steel

Standard Finish

- Cages: zinc plated, chrome finish

Options

- NEC Version: 13 Amp, 125 Vac receptacle rating.
- CEC Version 15 Amp, 120 Vac receptacle rating.

NEC/CEC Certification and Compliances ①

- UL Listed (with cord): E59071
- UL Listed (without cord): E59054
- UL Standard: 153
- CSA Certified (with cord): LL89639
- CSA Certified (without cord): LL56247
- CSA Standard: C22.2 No. 12

	Amp /Vac	with out Cord	Catalog Numbers	
			with 7.6 m (25') 16/3-SJTW Cord	with 15.2 m (50') 16/3-SJTW Cord
Closed-End Extension Lights				
Handle and cage	13 Amp/ 125 Vac	5000-G	5025-G	5050-G
Handle and cage	15 Amp/ 120 Vac	C5000-G ②	C5025-G ②	C5050-G ②
Handle and cage with reflector	13 Amp/ 125 Vac	5000-RG	5025-RG	5050-RG
Handle and cage with reflector	15 Amp/ 120 Vac	C5000-RG ②	C5025-RG ②	C5050-RG ②
Handle and cage, no receptacle	13 Amp/ 125 Vac	5000-GN	5025-GN	5050-GN
Handle and cage, no receptacle	15 Amp/ 120 Vac	C5000-GN ②	C5025-GN ②	C5050-GN ②
Handle and cage with reflector, no receptacle	13 Amp/ 125 Vac	5000-RGN	5025-RGN	5050-RGN
Handle and cage with reflector, no receptacle	15 Amp/ 120 Vac	C5000-RGN ②	C5025-RGN ②	C5050-RGN ②
Handle and non-metallic cage	13 Amp/ 125 Vac	—	5999-GH	—
Handle and non-metallic cage	15 Amp/ 120 Vac	—	C5999-GH ②	—
Handle and non-metallic cage with reflector	13 Amp/ 125 Vac	—	5999-RGH	—
Replacement Cord Sets			6229-1	6229-2
Cord set with molded plugs				
			Catalog Number	
			With Out Reflector	With Reflector
Cages				
Wire cage			8171	8170
Vinyl insulated metal cage (100 Watt A-21)			08171	08170
Non-metallic cage (100 Watt A-19)			—	8224
			Catalog Number	
			With Out Switch	
Handles and Sockets				
Handle and socket for 5000				0877
Handle and socket for 5000-N				0877-N
Socket for 5000 and 5000-N				00868

① 100 Watt Maximum for UL Listing and CSA Certification.

② Certified to meet the Canadian Electrical Code (CEC) only.

McGill™ Handy Compact Fluorescent Work Light

13 Watt

NEC:
Listed for Ordinary (Unclassified) Locations

Applications

- The compact light provides cool operation, allowing for work in small areas without excessive heat build-up or burns from accidental contact.

Features

- This energy-efficient work light features an exclusive 10,000 hour, 13 Watt rough service twin tube fluorescent lamp.
- Optional magnetic base with removable plastic swivel hook available.
- 13 Watt, 120 Volt PLC, 15 mm (0.59 in) lamp.
- Double insulated, enclosed electrical components.
- Convenient on/off switch under domed cap.
- Durable construction for industrial and commercial applications.

Standard Materials

- Cord and molded plug: 18 gauge SJTOW oil-resistant
- Outer tube with reflector break-resistant polycarbonate

NEC Certification and Compliances

- UL Listed: E59071
- UL Standard: 153



5331-0001



5331-0008

(Magnetic base and removable swivel hook assembly)

	Catalog Number
120V, 13 Watt lamp, 50.8 mm (2") diameter, 292.1 mm (11-1/2") length with 7.6 m (25'), 18/2-SJTOW yellow cord, in-line ballast, and built-in switch	5331-0001
Replacement 13 Watt lamp for 5331-0001 (shock resistant, rough service)	5331-0002
Magnetic base and removable swivel hook assembly	5331-0008
Scratch Guard	5331-0035

McGill™ Rough Service Fluorescent Lamp

13 Watt

NEC:
Listed for Ordinary (Unclassified) Locations

Applications

- The compact light provides cool operation, protecting personnel from accidental contact burns.

Features

- This 13 Watt energy-efficient work lamp provides light output equivalent to a 75-100 Watt incandescent with lamp life rated at 10,000 hours.
- Optional tool tap and scratch guard are available.
- Reflector directs light to work surface away from eyes.
- Scratch guard protects light.
- On/off switch, located under handle is water and dust resistant.
- Compact ballast located in handle.
- Rubber bumpers and handle protect light on impact.
- Exclusive in-line tool tap (110 Volt) with outlet cover.

Standard Materials

- Cord and molded plug: 16 or 18 gauge SJTOW oil-resistant
- Adjustable hooks with cushion tips: spring steel

NEC Certification and Compliances

- UL Listed: E59071
- UL Standard: 153



5331-0034



5331-0008

(Magnetic base and removable swivel hook assembly)

	Catalog Number
Fluorescent Lamp	
13 Watt Handi-Light with tool tap and scratch guard, 7.6 m (25') 16/3-SJTOW	—
13 Watt Handi-Light with scratch guard and 7.6 m (25') 18/2-SJTOW	5331-0032
13 Watt Handi-Light with Saf-T-Tie insert: cord locking mechanism, tool tap, scratch guard and 457.2 mm (18") 16/3-SJTOW	5331-0034
Accessories and Replacement Parts	
13 Watt Handi-Light head kit with switch, ballast and scratch guard	5331-0033
Scratch guard only	5331-0035
13 Watt Handi-Light head kit with switch and scratch guard; less ballast	5331-0036
13 Watt lamp only (shock resistant, rough service)	5331-0002
Magnetic base and removable swivel hook assembly	5331-0008

McGill™ Fluorescent Work Lights

12 Volt, 13 Watt

NEC/CEC:
Rated for Ordinary (Unclassified) Locations

Applications

- For applications requiring low-voltage, bright, energy-efficient lighting.

Features

- The light is powered by a printed circuit, solid state ballast connected to the lamp base.
- Hook with protective plastic tip, allowing for the light to hang on user's belt or shoulder strap for hands-free operation.
- Models available with 6.1 m (20 ft) 18/2-SJTOW oil-resistant, low temperature cord or 0.3 m (1 ft) to 1.5 m neoprene black coil cord; both with male lighter plugs on the ends.
- Ideal for use in confined areas.
- Replaceable 13 Watt, 12 Volt, 12.5 Amp Vac twin tube lamp.
- Ballast designed to operate at -20 °C (-4 °F)
- Ballast protected against voltage surges up to 18 Volts.
- Convenient on/off switch.
- Optional battery pack with charger available.
- Optional magnetic base with removable plastic swivel hook available.

Standard Materials

- Single metal hook with protective plastic tip
- Break-resistant polycarbonate outer tube with reflector



5331-0003



5331-0004



5331-0008

(Magnetic base and removable swivel hook assembly)

	Catalog Number
Work Lights	
12 Volt, 13 Watt lamp, 50.8 mm (2 ft) dia., 292.1 mm (11.5 in) length with 6.1 m (20 ft) 18/2-SJTOW yellow cord and male lighter plug	5331-0003
12 Volt, 13 Watt lamp, 50.8 mm (2 ft) dia., 292.1 mm (11.5 in) length with 0.3 m (1ft) - 1.5 m (5 ft) coil cord and male lighter plug	5331-0004
Accessories and Replacement Parts	
13 Watt lamp only (shock resistant, rough service)	5331-0002
Magnetic base and removable swivel hook assembly	5331-0008

McGill™ Battery Pack with Charger

NEC/CEC:
Rated for Ordinary (Unclassified) Locations

Applications

- Ideal for use with 12 Volt, 13 Watt fluorescent work lights when working in remote areas. Charger plugs into 120 Vac and charges at 1.2 amps, 12 Vdc. Charger is furnished with 1.8 m (6 ft) cord and male lighter plug to insert into the female outlet of the battery. Charger then plugs directly into a 120 Volt outlet. If battery is discharged to recommended maximum depth, the charger requires 16 hours to fully recharge. As battery is charged, the output of the charger reduces to low level. Battery must be removed from the charger within three days. Fully charged battery will operate a work light for about 5 hours continuously

Features

- 7 Amp hour capacity, sealed lead acid type battery.
- Taper charger.
- Safety vent opens if battery is overheated.
- Battery furnished with 0.3 m (1 ft) power cord having female 12 Volt outlet.
- Battery pack:
 - 2.6 kgs (5.75 lbs)
 - 152.4 mm (6 in) height
 - 63.5 mm (2.5 in) width
 - 88.9 mm (3.5 in) length

Standard Material

- Battery case: rugged nylon with double zipper, closed cell foam padding on the sides and bottom
- 50.8 mm (2 in) adjustable web belt with quick release buckle
- Two "D" rings to connect the hooks of the shoulder strap
- Shoulder strap is 1524.0 mm (6 in) long with 0.3 m (1 ft) long foam pad, adjustable strap on each end.
- Triangular "D" ring provides a place to hang your light to give hands-free lighting.



5331-0005

Appleton®

GENERAL TEMPORARY LIGHTING

	Catalog Number
Battery Pack	
Battery pack, charger, shoulder strap, and case with belt	5331-0005
Accessories and Replacement Parts	
13 Watt, 12 Volt, 1.25 Amp DC lamp (shock resistant, rough service)	5331-0006
7 Amp hour battery assembly	5331-0007

McGill™ Fluorescent Industrial Extension Lights

NEC/CEC:
Listed for Ordinary (Unclassified) Locations

NEC:
Meets OSHA requirements

Applications

- Compact, lightweight with hinged hooks, these fluorescent extension lights were designed to carry and use virtually anywhere.

Features

- Ideal for use in confined areas.
- Emanates soft, glare-free light.
- Safe and durable, these lamps remain cool to the touch.
- Outer tube protects 15, 8, or 4 Watt lamps.
- Durable, heavy-duty construction throughout.
- Low energy, long-life.
- No exposed metal parts.

Standard Materials

- Impact resistant plastic

NEC/CEC Certification and Compliances

- UL Listed: E59071
- UL Standard: 153
- CSA Certified: LL89639
- CSA Standard: C22.2 No. 12



5330-1525



5330-0818

15 Watt Extension Lights

	Catalog Number	
	with 7.6 m (25 ft) Cord	with 15.2 m (50 ft) Cord
15 Watt lamp 54.1 mm (2.13 in) dia., 571.5 mm (22.5 in) length, with SJTO yellow cord — 18/3 from 3 prong plug to ballast, 18/2 to lamp. No. F15T8/CW bulb and FS-2 starter furnished	5330-1525	5330-1550
15 Watt lamp 54.1 mm (2.13 in) dia., 571.5 mm (22.5 in) length, with SJTW yellow cord — 16/3 from 3 prong plug to ballast, 18/2 to lamp. No. F15T8/CW bulb and FS-2 starter furnished	5332-1525 ①	—

4 and 8 Watt Extension Lights

	Catalog Number — 18/2-SJTO Cord		
	with 4.6 m (15 ft)	with 6.7 m (22 ft)	with 7.6 m (25 ft)
4 Watt, F4T5/CW; 279.4 mm (11 in) overall length	5330-0411	5330-0418	—
8 Watt, F8T5/CW; 431.8 mm (17 in) overall length	5330-0811	5330-0818	—
8 Watt, F8T5/CW; 431.8 mm (17 in) overall length	—	5332-0818 ①	5332-0825 ①

Accessories and Replacement Parts

	Catalog Number
Plastic shield for 5330-0411 and 5330-0418	—
Hook only for 5330-0411, -0418, -0811, and -0818	5330-0401
Plastic shield for 5330-0811 and 5330-0818	5330-0800
Plastic shield for 5330-1525	5330-1500
Hooks, plastic, set of two (2) for 5330-1525	5330-1501

① Certified to meet the Canadian Electrical Code (CEC) only.

McGill™ High Intensity Low-Voltage Extension Lights

NEC/CEC:
Rated for Ordinary (Unclassified) Locations

Features

- Compact, durable, and safe 30 Watt spot and 35 Watt flood lights.
- Ideal for use where low-voltage and maximum illumination are needed.
- Powerpak transformer converts 120 Vac to 12 Vac, also available as separate item.
- Spot and flood light available with battery clips where no voltage conversion is necessary.
- Available with battery clips where no voltage conversion is necessary.
- Heavy-duty cords, plugs, and connectors.
- TWIST-LOK connector permits economical cord and lamp replacement.

Standard Materials

- Bulb and powerpak transformer
- Secondary cord: 15.2 m (50 ft) 16/2-SJTO
- Handle: impact-resistant plastic
- Lens: polycarbonate



5329-4000

	Catalog Number	
	with Power Pack Transformer	with Battery Clips
Complete unit with 30 W, 50,000 candle power spot bulb; 15.2 m (50 ft) 16/2-SJTO cord and plug	5329-4000 ①	5329-4001 ①
Complete unit with 35 W, 325 candle power flood bulb; 15.2 m (50 ft) 16/2-SJTO cord and plug	5329-4010 ②	5329-4011 ②

Accessories and Replacement Parts

	Catalog Number
Mini-Powerpak with 15.2 m (50 ft) 16/3-SOW primary cord	5329-0015
30 Watt spot light with 15.2 m (50 ft) 16/2-SJTO cord and TWIST-LOK connector	5329-4002 ①
35 Watt flood light with 15.2 m (50 ft) 16/2-SJTO cord and TWIST-LOK connector	5329-4012 ②
Plastic lens	5329-4003
Lens retaining ring	5329-4004

① Accommodates G.E. bulb #4405 and 4405-1.

② Accommodates G.E. bulb #4422.

McGill™ Mini-Powerpak Low-Voltage Extension Lights

NEC:
Rated for Ordinary (Unclassified) Locations

NEC:
Meets OSHA requirements

Features

- Lightweight, compact transformer converts 120 Vac to 12 Vac lighting.
- Under 2.7 kgs (6 lbs) total weight.
- Transformer potted and sealed to resist moisture.
- Fuse protected primary fuse.
- TWIST-LOK connector.
- 75 W low-voltage bulb included.

Standard Material

- Extension light
- Transformer: 76.2 x 88.9 x 177.8 mm (3 x 3-1/2 x 7 in)
- Power cord: 1.5 m (5 ft) 16/3-SOW



5329-7010

Appleton®

GENERAL TEMPORARY LIGHTING

	Catalog Number
Extension Lights	
Complete unit with power supply cord, Mini-Powerpak transformer	
7000-G extension light with 7.6 m (25 ft) 16/3-SJTW Cord	5329-7000
7000-RG extension light with 7.6 m (25 ft) 16/3-SJTW Cord	5329-7010
Accessories and Replacement Parts	
Mini-Powerpak with 1.5 m (5 ft) 16/3-SOW primary cord	5329-0015
7.6 m (25 ft) 16/3-SJTW secondary cord assy., with TWIST-LOK plug	5329-0003
75 Watt low-voltage medium base A-21 bulb	6461

McGill™ Fluorescent Hand Lamps

Explosionproof. 13 Watt Twin Tube and 26 Watt Quad

NEC:
 Class I, Division 1, Groups C, D
 Class II, Division 1, Groups F, G

Features

- This portable, fluorescent light features durable, heavy-duty construction with non-metallic guard, swivel hook and handle assembly.
- The handle holds a 125 Volt rated ballast designed to operate on 50 or 60 Hz with recyclable thermal protection.
- "T" Number: T6.
- Easy maintenance.
- Completely watertight.
- No exposed metal parts.
- 900 lumens for 13 Watt unit.
- 1800 lumens for 26 Watt unit.
- Corrosion-resistant.
- 101.6 mm (4 in) outside diameter.
- 596.9 mm (23.5 in) length.
- 1.6 kgs (3.5 lbs)

Standard Materials

- Globe: tempered glass

NEC Certification and Compliances

- UL Listed: E43473
- UL Standard: 844



5227-0006

Appleton®

GENERAL TEMPORARY LIGHTING

	Catalog Number
13 Watt Twin Tube Selection Chart	
Hand lamp with 15.2 m (50 ft) 16/3-SO cord (male plug not included)	5227-0003
Twin tube hand lamp with out cord	5227-0006
26 Watt Quad Tube Selection Chart	
Hand lamp with 15.2 m (50 ft) 16/3-SO cord (male plug not included)	5227-0007
Quad tube hand lamp with out cord	5227-0008

McGill™ Tubular Fluorescent Inspection Light

Explosionproof. 8 Watt

NEC:
Class I, Division 1, Group D
Class II, Group G

Applications

- This inspection light is ideal for inspection of aircraft fuel systems because of its narrow diameter, light weight and cool operating temperature.

Features

- Furnished with high impact aluminum alloy guard and non-sparking swivel hook.
- "T" Number: T5.
- Easy maintenance — only glass globe requires factory replacement.
- 450 lumens.
- 63.5 mm (2.5 in) outside diameter.
- 685.8 mm (27 in) length.
- 1.5 kgs (3.3 lbs)

NEC Certification and Compliances

- UL Listed: E43473
- UL Standard: 844



5227-0004

	Catalog Number
Hand lamp with 15.2 m (50 ft) 16/3-SO cord (male plug not included)	5227-0004

McGill™ Industrial Extension Lights

Explosionproof

NEC:
Class I, Division 1, Groups C, D

Features

- This watertight portable extension light features a lightweight aluminum alloy guard with a non-sparking swivel hook, as well as a chemical-resistant handle and globe holder.
- High impact glass globe accepts an A-21.
- The one-piece construction of the 15 Amp, 240 Vac socket withstands temperatures up to 182 °C (360 °F) in service.
- "T" Number: T3A.
- Completely watertight.
- Accommodates 16/3-SO or 14/3-SO cord.
- 127 mm (5 in) outside diameter.
- 469.9 mm (18.5 in) length.
- 1.8 kgs (4 lbs).

Standard Materials

- 100 Watt rough service bulb

NEC Certification and Compliances

- UL Listed: E43473
- UL Standard: 844



5227-0005

	Catalog Number
Extension Lights	
Hand lamp with 15.2 m (50 ft) 16/3-SO cord (male plug not included)	5227-0001
Hand lamp with out cord	5227-0005
Accessories and Replacement Parts	
Handle assembly and lamp holder	5227-9915
Guard and globe assembly	5227-9916

McGill™ Low-Voltage, High Intensity Hand Lamp Explosionproof

NEC:
Class I, Division 1, Groups C, D

Applications

- Ideal for inspecting refinery towers, manholes, or railroad tank cars.

Features

- This low-voltage spotlight uses a 12 Volt, PAR-36, 30 Watt, automotive type, sealed beam high intensity lamp.
- The aluminum light guard is high impact alloy and swivel hook is non-sparking.
- "T" Number: T3C.
- 30,000 beam candlepower.
- 6.4 mm (0.25 in) thick glass lens.
- Can be powered by low-voltage transformer or alternate 12 Volt source.
- 139.7 mm (5.50 in) outside diameter.
- 406.4 mm (16 in) length including hook.
- 1.4 kgs (3 lbs).

Standard Materials

- Light guard: aluminum

NEC Certification and Compliances

- UL Listed: E43473
- UL Standard: 844



5227-0002

Appleton

GENERAL TEMPORARY LIGHTING

	Catalog Number
Hand lamp with 15.2 m (50 ft) 16/3-SO cord (male plug not included)	5227-0002

McGill™ Fluorescent Utility Lights

NEC/CEC:

Listed for Ordinary (Unclassified) Locations

Applications

- Whether the application calls for securely lighting a livestock operation, damp barn, or even a harsh, outdoor environment, the 22 Watt fluorescent utility light delivers energy-efficient, trouble-free service for a variety of demanding lighting needs. The single unit incorporates non-corrosive construction, its own wiring compartment, and an impact-resistant thermoplastic mounting base.

Features

- Removable globe for effortless “push-pull” relamping and cleaning.
- Standard 15 mm (0.59 in), 22 Watt quad-tube lamp provides 75% greater energy efficiency.
- Average service life of 10,000 hours.
- Fastens directly to walls, ceilings, or structural members.
- 88.9 mm (3.5 in) diameter, 241.3 mm (9.5 in) height.
- Two 7.9 mm (0.31 in) diameter mounting holes on 111.3 mm (4.48 in) centers.
- 22 Watt, 120 Volt PLC, 15 mm (0.59) lamp equivalent to 75 Watt incandescent.
- Delivered complete with globe, ballast, lamp, socket and wiring box.
- For use up to 38 °C (100 °F) ambient temperature.
- Use with either 12.7 mm (0.5 in) or 19.1 mm (0.75 in) rigid non-metallic conduit.



600-FL22

NEC/CEC Certification and Compliances

- UL Listed: E13761
- UL Standard: 1598
- CSA Certified: LL56247
- CSA Listed: C22.2 No. 250.0

	Wiring Compartment Cubic Decimeter (Cubic Inch)	Supply Wire Rating °C (°F)	Catalog Numbers	
			12.7 mm (0.5 in) Threaded Conduit Opening	19.1 mm (0.75 in) Threaded Conduit Opening
Utility light with glass globe				
For damp locations	0.20 (12)	90 (194)	600-FL22	601-FL22
For damp locations	0.20 (12)	105 (221)	C600-FL22 ②	C601-FL22 ②
Sealed unit for wet locations	0.20 (12)	90 (194)	605-FL22	606-FL22
Sealed unit for wet locations	0.20 (12)	105 (221)	C605-FL22 ②	C606-FL22 ②
Utility light with clear plastic prismatic globe				
For damp locations	0.20 (12)	90 (194)	640-FL22	641-FL22
For damp locations	0.20 (12)	105 (221)	C640-FL22 ②	C641-FL22 ②
Sealed unit for wet locations ①	0.20 (12)	90 (194)	645-FL22	646-FL22
Sealed unit for wet locations ①	0.20 (12)	105 (221)	C645-FL22 ②	C646-FL22 ②
Utility light with red plastic prismatic globe				
For damp locations	0.20 (12)	90 (194)	650-FL22	651-FL22
For damp locations	0.20 (12)	105 (221)	C650-FL22 ②	C651-FL22 ②
Sealed unit for wet locations ①	0.20 (12)	90 (194)	655-FL22	656-FL22
Sealed unit for wet locations ①	0.20 (12)	105 (221)	C655-FL22 ②	C656-FL22 ②

Accessories and Replacement Parts – Additional plastic globes see Protect-O-Globes

	Catalog Number
Glass globe only - 220.7 mm (8.68 in) long	0753
Clear plastic prismatic globe only - 209.6 (8.25) mm long	5213-6649
Red plastic prismatic globe only - 209.6 (8.25) mm long	5213-6659
Protective metal cage for glass globes only	1435-6
22 Watt, 120 Volt PLC, 15 mm (0.59 in) lamp	5213-6660
Base, socket, and ballast assembly only for 600-FL22	5213-6623
Base, socket, ballast, and seal assembly only for 605-FL22	5213-6625

① For base-up operation only.

② Certified to meet the Canadian Electrical Code (CEC) only.

McGill™ Incandescent Utility Lights

NEC/CEC:
Listed for Ordinary (Unclassified) Locations

Applications

- Ideal for food processing plants, barns, garages, warehouses, and workshops.
- Low cost, corrosion-resistant, enclosed utility lights, complete with base, wiring box, and globe, are convenient to use.

Features

- Fasten directly to walls, ceilings, or structural members — no separate outlet box required.
- Glass or plastic globes screw out for easy replacement of A-21 bulbs (not included) up to 150 Watts.
- High quality materials and sockets assure long, trouble-free service life.
- 88.9 mm (3.5 in) diameter; 241.3 mm (9.5 in) height
- Two 7.9 mm (0.31) diameter mounting holes on 111.3 mm (4.38 in) centers.
- Moisture-resistant construction with no exposed metal parts.
- Large compartment for easy wiring.
- Super strong, impact-resistant, thermoplastic mounting unit.
- For use up to 38 °C (100 °F) ambient temperature.
- Accommodates up to 150 Watts max. domestic A-21 bulbs.
- For use with either 12.7 mm (1.5) or 19.1 mm (0.75 in) rigid non-metallic conduit.

NEC/CEC Certification and Compliances

- UL Listed: E22558
- UL Standard: 1598
- CSA Certified: LL56247
- CSA Listed: C22.2 No. 250.0



606 with 1435-6



653

GENERAL UTILITY LIGHTS

Appleton®

McGill™ Incandescent Utility Lights

NEC/CEC:
Listed for Ordinary (Unclassified) Locations

	Wiring Compartment Cubic Decimeter (Cubic Inch)	Supply Wire Rating °C (°F)	Catalog Numbers	
			12.7 mm (0.5 in) Threaded Conduit Opening	19.1 mm (0.74) Threaded Conduit Opening
Utility light with glass globe				
For damp locations	0.25 (15)	125 (257)	600	601
For damp locations	0.25 (15)	105 (221)	C600 ③	C601 ③
For damp locations	0.20 (12)	60 (140)	603	604
For damp locations	0.20 (12)	60 (140)	C603 ③	C604 ③
Sealed unit for wet locations	0.20 (12)	60 (140)	605	606
Sealed unit for wet locations	0.20 (12)	60 (140)	C605 ③	C606 ③
Utility light with clear plastic globe ①				
For damp locations	0.25 (15)	125 (257)	640	641
For damp locations	0.25 (15)	105 (221)	C640 ③	C641 ③
For damp locations	0.20 (12)	60 (140)	643	644
For damp locations	0.20 (12)	60 (140)	C643 ③	C644 ③
Utility light with red plastic globe ①				
For damp locations	0.25 (15)	125 (257)	650	651
For damp locations	0.25 (15)	105 (221)	C650 ③	C651 ③
For damp locations	0.20 (12)	60 (140)	653	654
For damp locations	0.20 (12)	60 (140)	C653 ③	C654 ③
Accessories and Replacement Parts — Additional plastic globes see Protect-O-Globes				
				Catalog Number
Protective metal cage for glass globes only				1435-6
Base and socket only for 600, 640, and 650				610
Base and socket only for 601, 641, and 651				611
Base and socket only for 603, 643 and 653				5213-0623
Base and socket only for 604, 644 and 654				5213-0672
Base, socket, and seal assembly only for 605				5213-0637
Base, socket, and seal assembly only for 606				5213-0638
Socket only for 0.25 cubic decimeter (15 cubic inch) wiring compartment				600-3
Socket only for 0.20 cubic decimeter (12 cubic inch) wiring compartment				606-3
Glass globe only for 600, 601, 603, and 604 - 296.9 mm (6.69 in) long				0753
Glass globe only for 605 and 606 - 296.9 mm (6.69 in) long				0753-HR ②
Clear plastic globe only for 640, 641, 643 and 644 - 6.1 mm (6.13 in) long				649
Red plastic globe only for 650, 651, 653 and 654 - 6.1 mm (6.13 in) long				659
Green plastic globe only - 6.1 mm (6.13 in) long				669

① Plastic globes max. 75 Watt base-up mounting.
 ② Heat resistant globes required for wet locations.
 ③ Certified to meet the Canadian Electrical Code (CEC) only.

McGill™ Fluorescent Lamp Changers

Grips Lamp

NEC/CEC:
Rated for Ordinary (Unclassified) Locations

Applications

- Eliminate the need for climbing ladders and scaffolds.

Features

- Changers securely grip lamps for easy removal.
- Two models to choose from.
- Models for spring-loaded, bi-pin, single-pin, or recessed double contact lamps.



174



184

Catalog Number

Lamp Changers

Complete changer unit for up to 38.1 mm (1.5 in) diameter, 1.2 m (4 ft) lamps that require 90° rotation or axial movement. Includes changer head, four zinc-plated steel pole sections each 609.6 mm (24 in) long, and starter changer. For T-8, T-10, T-12 single-pin, T-8, T-12 med. bi-pin, and T-10, T-12 recessed double contact lamps.

174

Complete changer unit for 38.1 mm (1.5 in) diameter, spring-loaded lamps up to 2.4 m (8 ft) long. Includes changer head and two-section aluminum telescoping pole extending to 3.8 m (12.5 ft).

184

Accessories and Replacement Parts

Zinc-plated 0.6 m (2 ft) steel pole section for 174

170-P

Zinc-plated steel changer head only for 174

171-C

Aluminum starter changer only for 174

173-S

Fluorescent changer pull cord only for 174

01540

Yellow driver, five clips, and speed nuts for 184

5274-1743

Changing Lamps is Easy With McGill Fluorescent Lamp Changers

- First, angle changer to wedge yellow driver between lamp and socket. Then snap changer onto tube by rocking changer gently.
- Next, standing at end of changer, push pole so driver will extract fluorescent lamp out of socket.

Model #184

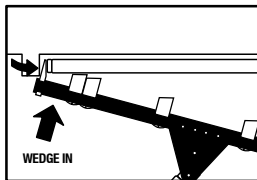

Wedge driver between lamp and socket.

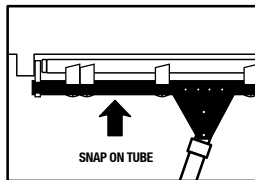

Snap changer onto tube. Rock changer onto lamp.

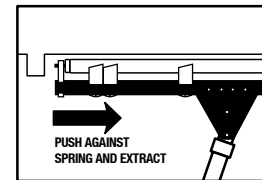

Push against changer spring and extract.

Lamp Identification

The changers featured on this page accommodate the fluorescent lamps at right.

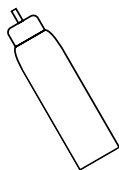

Single-pin: T-8, T-10, T-12

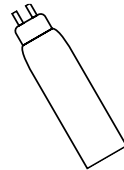

Medium bi-pin: T-8, T-12

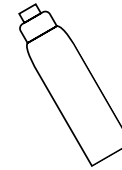

Recessed double contact: T-10, T-12

McGill™ Incandescent Lamp Changers

Rubber Covered Fingers with Garter Springs

NEC/CEC:
Rated for Ordinary (Unclassified) Locations

Features

- Rubber covered fingers with garter springs make changing a variety of lamp types simple.
- Hard-to-reach lamps are easily replaced without using ladders or platforms.
- A variety of styles and sizes is available to fit practically all commonly used lamps.
- Models for use with incandescent, mercury, metal halide, and sodium lamps.
- Garter spring grips lamps firmly.
- Lightweight for ease-of-use and convenience.
- Insulated to help protect against shock.
- Changes lamps up to 7.6 m (25 ft) height (poles sold separately).



151-CA



153-C



161-C

	Lamp Size ①	Wattage	Catalog Number
Changer head with angle adjustment ②	A-15, -17, -19; G-16-1/2, -18-1/2	15-100	150-CA
Changer head with angle adjustment ②	A-19, -21, -23; P-25; PS-25, -30, -35; FLE-20/T-19 ③; SL-18 ③; G-25, -30	25-500 (18 fluorescent ③)	151-CA
Changer head only	PS-35, -40; G-40, -48	25-500	152-C
Changer head only	PS-52; G-48, -64	750-1500 (incandescent)	153-C
Changer head only	T-16, -18, -20	1000-1500 (incandescent) 400-1000 (mercury)	154-C
Changer head only	R-52, -57	500-1000 (incandescent flood) 400-750 (mercury)	155-C
Changer head only	R-30, -40; PAR-30, -36, -38; ER-30, -40	50-500 (incandescent) 100-175 (mercury)	156-C
Changer head only	E-37; BT-37, -46; ED-37	400-700 (mercury) 400-1000 (metal halide)	158-C
Changer head only	R-60	750 (incandescent) 400 (mercury flood)	159-C
Changer head only	E-21, -23, -23-1/2, -25, -28; ED-23-1/2, -28; BT-28	75-250 (mercury) 175-400 (metal halide) 50-1000 (sodium)	161-C
Changer head only	E-17, -18; ED-17, -18; B-17	50 (mercury) 35-400 (sodium) 70-175 (metal halide)	163-C

Lamp Identification

A lamp designation consists of a letter indicating the shape and a figure to identify the approximate diameter in eighths of an inch. Lamps are measured through their greatest diameter. G-25 lamps are globe shaped with a 79.5 mm (3.13 in) diameter.

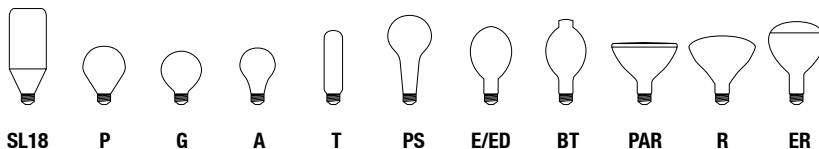

- ① Lamp size, not wattage, determines proper changer. May not accommodate weight of greater Wattage lamps.
 ② Jointed angle adapter for easy removal of horizontally or angle mounted lamps included. Use with small headed units only.
 ③ Not for use with angle adapter.

McGill™ Incandescent Lamp Changers

Rubber Suction Cups

NEC/CEC:
Rated for Ordinary (Unclassified) Locations

Features

- Rubber suction cups make it easy to change lamps where space surrounding bulbs is limited.
- Made of durable synthetic rubber, these changers securely fasten onto lamps and allow for safely changing lamps up to 7.6 m (25 ft) heights (poles sold separately).
- For lamps with smooth face only.



157-C



162-C



166-C

	Lamp Size ①	Wattage	Catalog Number
Changer with rubber suction cups	R-40, -52, RB-52	75-1000 (incandescent spot/flood)	157-C
Changer with rubber suction cup	PAR-30, -36, -38	25-150 (incandescent)	162-C
Changer with rubber suction cup	R-20, -30, ER-30, PAR-20	30-75 (incandescent)	166-C

LAMP CHANGERS

Appleton®

① Bulb size, not Wattage, determines changer to be used. Use on smooth surface lamps only.

McGill™ Lamp Changer Accessories and Replacement Parts

NEC/CEC:
Rated for Ordinary (Unclassified) Locations

Application

- Lightweight accessories and replacement parts provide a safe and sure way to remove and replace bulbs.

Features

- For use with incandescent lamp changers, these 1.5 m (5 ft) insulated, interchangeable pole sections are designed for quick assembly to desired length. Up to four poles can be securely locked together with spring-loaded buttons.
- Broken lamp base remover has plastic shield designed to catch fragments and help protect user. Fits 160-P lamp changer pole, providing a fully insulated, safe, and sure way to remove bases of broken lamps.



200



9260

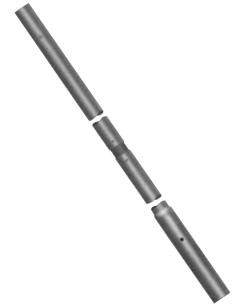

160-P

	Catalog Number
Interchangeable, wood insulated steel pole, 1.5 m (5 ft) sections	160-P
Broken lamp base remover for standard and mogul lamp bases	200
Garner springs for 150-CA, 151-CA, 154-C, 161-C changer heads	7013
Garner springs for 152-C, 153-C, 156-C, 158-C changer heads	7014
Garner springs for 155-C and 159-C changer heads	7019
Spring clip and button for lamp changer poles	9260

LAMP CHANGERS

Appleton®

McGill™ Protect-O-Sleeves

For Fluorescent Tubes

NEC:
Rated for Ordinary (Unclassified) Locations
Meets OSHA safety requirements

Applications

- Reusable Protect-O-Sleeves encase existing fluorescent tubes to insulate and improve lighting efficiency at low temperatures.
- High tensile, polycarbonate strength protects people, equipment, and products.

Features

- Furnished with end caps that fit snugly between lamp and sleeve.
- Insulates lamps up to 2.5 times at -6 °C (20 °F).
- Accommodates lamps up to 800 milliamps ①.
- For use up to 38 °C (100 °F) ambient temperature.
- Most T-8 and T-12 versions available in colors.



2260 (T-12)



2270 (T-8)



2546 (T-5)

T-5 Clear Protect-O-Sleeves ②

Lamp Type	Nominal Lamp Length Millimeters (Inches)	Catalog Number for Sleeve with 2 Caps for T-5 Diameter Lamps	Box Quantity
F-14	558.8 (22)	2522	48
F-21	863.6 (34)	2534	24
F-28	1168.4 (46)	2546	24

T-8 and T-12 Clear Protect-O-Sleeves ①

Lamp Type	Nominal Lamp Length Millimeters (Inches)	Catalog Number for Sleeve with 2 Caps for T-12 Diameter Lamps	Catalog Number for Sleeve with 2 Caps for T-8 Diameter Lamps	Box Quantity
F-15	457.2 (18)	—	2270	24
F-20	609.6 (24)	2268	2278	24
F-30	914.4 (36)	—	2271	24
F-32	1219.2 (48)	—	2295	24
F-36	914.4 (36)	2269	—	24
F-40	1219.2 (48)	2260	—	24
F-40	1524.0 (60)	—	2286	24
F-48	1168.4 (46)	2261	—	24
F-60	1524.0 (60)	2276	—	24
F-72	1828.8 (72)	2262	2272	24
F-96	2438.4 (96)	2263	2273	24

① No. 2285 heat sink screens must be used with T-8 and T-12 800-milliamp maximum HO lamp bases. Two heat sink screens required per sleeve (one at each end between lamp and sleeve). HO lamps create excessive heat at the ends. The open metal mesh of the heat sink screens spreads the excess heat over a larger area to help eliminate deterioration of the sleeve. **NOT for use with VHO lamps.**

② **NOT for use with HO or VHO lamps.**

McGill™ Protect-O-Sleeves

For Fluorescent Tubes

NEC:
Rated for Ordinary (Unclassified) Locations
Meets OSHA safety requirements

Colored Protect-O-Sleeves ①

Lamp Type	Catalog Numbers for Sleeve with 2 Caps					Box Quantity
	Blue	Green	Pink	Red	Yellow	
F-32, T-8	2295-B	2295-G	2295-P	2295-R	2295-Y	12
F-40, T-12	2260-B	2260-G	2260-P	2260-R	2260-Y	12
F-48, T-12	2261-B	2261-G	2261-P	2261-R	2261-Y	12
F-72, T-12	2262-B	2262-G	2262-P	2262-R	2262-Y	12
F-96, T-8	2273-B	2273-G	2273-P	2273-R	2273-Y	12
F-96, T-12	2263-B	2263-G	2263-P	2263-R	2263-Y	12

Accessories and Replacement Parts

	Catalog Number
Universal end cap for T-5, 2500 series	2508
Universal end cap for T-12, 2260 series	2265
Heat sink screen for HO lamp bases	2285 ①
Universal end cap for T-8, 2270 and 2295 series sleeves produced prior to 8-1-97	2274
Universal end cap for T-8, 2270 and 2295 series sleeves produced after 8-1-97	2279

① No. 2285 heat sink screens must be used with T-8 and T-12 800-milliamp maximum HO lamp bases. Two heat sink screens required per sleeve (one at each end between lamp and sleeve). HO lamps create excessive heat at the ends. The open metal mesh of the heat sink screens spreads the excess heat over a larger area to help eliminate deterioration of the sleeve. **NOT for use with VHO lamps.**

McGill™ Tubeloc Holders

NEC/CEC:
Listed for Ordinary (Unclassified) Locations

Applications

- Securely position and hold tubes in fluorescent fixtures

Features

- Shock resistant
- Styles to fit most fluorescent lamps in use today

Standard Finish



- Holders: shock resistant nylon

NEC/CEC Certification and Compliances

- UL Listed: E109438
- UL Standard: 1598
- CSA Certified: LL36636
- CSA Standard: C22.2



M180

	Description	Catalog Number
	T-8 and T-12 Bi-pin, 14-40 Watts	M175
	T-12 Recessed double contact; Slimline single-pin; medium bi-pin; T-17 power groove with recessed double contact base (19.1 mm (0.75 in) dia. plunger)	M176
	T-17 Bi-pin mogul base	M180

McGill™ Protect-O-Globes

For Incandescent Bulbs

NEC:
 Rated for Ordinary (Unclassified) Locations
 Meets OSHA requirements

Applications

- Protect lamps and the working environment with economical polycarbonate globes that are virtually unbreakable.
- Ideal for the replacement of glass and wire guard combinations where incandescent or HID lamps are used in vandal-proof applications.

Features

- Various styles, sizes, and colors available.
- Prismatic globes provide lateral light diffusion.
- Smooth globes reduce operating temperatures, amplify light source.
- Accommodates up to 150 Watts maximum, base-up operation.



1500-C



0604AP



3316

Description	Color	Finish	Thread Diameter mm (in)	Globe Dimensions Millimeters (Inches) – W x L	Maximum Wattage	Catalog Number
Globes						
209.6 mm (8.25 in) cylinder	Clear	Prismatic	82.6 (3.25)	88.9 x 209.6 (3.50 x 8.25)	60	0134CP ①
209.6 mm (8.25 in) cylinder	Clear	Smooth	82.6 (3.25)	88.9 x 209.6 (3.50 x 8.25)	60	0134CS ①
211.1 mm (8.31 in) cylinder	Clear	Smooth	108.0 (4.25)	120.7 x 211.1 (4.75 x 8.31)	150	1500-C
158.8 mm (6.25 in) bullet	Clear	Smooth	82.6 (3.25)	95.3 x 158.8 (3.75 x 6.25)	60	0603CS ①
158.8 mm (6.25 in) bullet	Green	Smooth	82.6 (3.25)	95.3 x 158.8 (3.75 x 6.25)	60	0603GS ①
158.8 mm (6.25 in) bullet	Red	Smooth	82.6 (3.25)	95.3 x 158.8 (3.75 x 6.25)	60	0603RS ①
158.8 mm (6.25 in) bullet	Amber	Smooth	82.6 (3.25)	95.3 x 158.8 (3.75 x 6.25)	60	0603AS ①
158.8 mm (6.25 in) cylinder	Clear	Smooth	82.6 (3.25)	95.3 x 158.8 (3.75 x 6.25)	60	0604CS ①
158.8 mm (6.25 in) cylinder	Clear	Smooth	81.0 (3.15)	94.5 x 152.4 (3.72 x 6.0)	75	0752-C
158.8 mm (6.25 in) cylinder	Green	Smooth	82.6 (3.25)	88.9 x 158.8 (3.5 x 6.25)	60	0604GS ①
158.8 mm (6.25 in) cylinder	Red	Smooth	82.6 (3.25)	88.9 x 158.8 (3.5 x 6.25)	60	0604RS ①
158.8 mm (6.25 in) cylinder	Amber	Smooth	82.6 (3.25)	88.9 x 158.8 (3.5 x 6.25)	60	0604AS ①
158.8 mm (6.25 in) cylinder	Clear	Prismatic	82.6 (3.25)	88.9 x 158.8 (3.5 x 6.25)	60	0604CP ①
158.8 mm (6.25 in) cylinder	Clear	Prismatic	81.0 (3.15)	94.5 x 152.4 (3.72 x 6.0)	75	0752-P
158.8 mm (6.25 in) cylinder	Green	Prismatic	82.6 (3.25)	88.9 x 158.8 (3.5 x 6.25)	60	0604GP ①
158.8 mm (6.25 in) cylinder	Red	Prismatic	82.6 (3.25)	88.9 x 158.8 (3.5 x 6.25)	60	0604RP ①
158.8 mm (6.25 in) cylinder	Amber	Prismatic	82.6 (3.25)	88.9 x 158.8 (3.5 x 6.25)	60	0604AP ①
Bases						
Yellow plastic base for use with 0752-C/P globes			81.0 (3.15)	87.4 x 41.4 (3.44 x 1.63)	75	3316
Yellow plastic base for use with 1500-C globe			108.0 (4.25)	87.4 x 41.4 (3.44 x 1.63)	150	4014

Dimensions

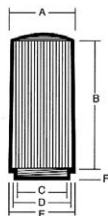

Cylinder Prismatic

- A - 88.9 mm (3.5 in)
- B - 190.5 mm (7.5 in)
- C - 76.2 mm (3.0 in)
- D - 82.6 mm (3.25 in)
- E - 95.3 mm (3.75 in)
- F - 12.7 mm (0.5 in)

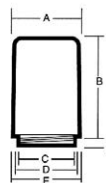

Cylinder Smooth

- A - 88.9 mm (3.5 in)
- B - 139.7 mm (5.5 in)
- C - 76.2 mm (3.0 in)
- D - 82.6 mm (3.25 in)
- E - 95.3 mm (3.75 in)
- F - 12.7 mm (0.5 in)

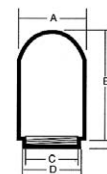

Bullet Smooth

- A - 95.3 mm (3.75 in)
- B - 139.7 mm (5.25 in)
- C - 76.2 mm (3.0 in)
- D - 82.6 mm (3.25 in)
- E - 12.7 mm (0.5 in)

① Can be used with McGill Incandescent and Fluorescent Utility Lights.

McGill™ Wire Lamp Guards and Wire Lamp Guard Grounding Kit

NEC:
Rated for Ordinary (Unclassified) Locations
Meets OSHA requirements

Applications

- Wire lamp guards with universal collars help prevent breakage and theft.









Features

- A wide variety of types and sizes is available to fit your diverse needs.
- Heavy-duty, 10 or 12 gauge, zinc-plated construction ensures long life.
- Easy to install.
- Vinyl coated versions available.
- Rust-resistant zinc plating with chromate finish.
- Clamp type guards for vapor-tight fixtures available.
- Spot welded steel wire ensures long life.

Application

- To ensure that your lamps are grounded, and comply with NEC and OSHA requirements, the grounding kit supplies a metal fastener and 0.3 m (1 in) wire to connect wire lamp guards to a grounding circuit.

Wire Lamp Guards

	Description	Collar Diameter Millimeters (Inches)	Catalog Number	
			for 100 W Bulb	for 200 W Bulb
	GRIPON guards with out reflectors	38.1 (1.50)	2100-2100-A	2200-2200-A
	Vinyl coated GRIPON guards with out reflectors	38.1 (1.50)	V-2100BULK	V-2200BULK
	PROTECTOR "O" guards; open bottom heavy-duty	38.1 (1.50)	1433	1434
	Vinyl coated PROTECTOR "O" guards	38.1 (1.50)	V-1433	V-1434
	Trap only to close bottom of 1433 and 1434	—	2932	2933
	Closed bottom wall and receptacle lamp guards	88.9 (3.50)	1438	—
	Cage for utility light ①	88.9 (3.50)	1435-6	—
	Guards for PAR and R-38 lamps	42.6 - 66.8 (1.69 - 2.63)	1438-1	—
	Guards for vapor-tight fixtures	95.25 (3.75)	1435-1	1435-3 ②

Wire Lamp Guard Grounding Kit

	Description	Catalog Number
	Grounding Kit	9995

① See McGill Incandescent and Fluorescent Utility Lights. Plastic cages available, see McGill String-O-Lights.

② 300 Watt type PS25 lamp only.

Notes

Notes

Notes

Notes

Notes

Notes

Notes

Notes

Notes

Notes

Notes

Notes

Notes

Notes

Notes

Notes

Emerson brings integrated manufacturing solutions to diverse industries worldwide. Our comprehensive product line, extensive experience, world-class engineering and global presence enable us to implement solutions that give our customers the competitive edge. Appleton is our premium line of lighting and electrical products for hazardous and industrial locations.

For over 150 years, our electrical product brands have been providing a rich tradition of long-term, practical, high quality solutions with applications ranging from the construction and safe operation of petrochemical and process plants to providing quality power that precisely controls automotive robotic production.

Engineers, distributors, contractors, electricians and site maintenance professionals around the world trust Emerson brands to make electrical installations safer, more productive and more reliable.

The Appleton Group business unit of Emerson is organized into three focused groups that provide distributors and end users expert knowledge and excellent service.

Electrical Construction Materials

This group is made up of the Appleton and O-Z/Gedney brands. They manufacture a broad range of electrical products including conduit and cable fittings, plugs and receptacles, enclosures and controls, conduit bodies and industrial and hazardous lighting. Whether the application is hazardous location, industrial or commercial, the electrical construction materials group has the products to meet your needs.

Power Quality Solutions

The SolaHD brand offers the broadest power quality line, including uninterruptible power supplies, power conditioners, voltage regulators, shielded transformers, surge protection devices and power supplies.

Heating Cable Systems

This group is made up of the EasyHeat and Nelson brands. They offer a broad range of electrical heating cable products for residential, commercial and industrial applications.

Asia/Pacific
+ 65.6556.1100

Australia
+ 61.3.9721.0348

Canada
+ 1.888.765.2226

China
+ 86.21.3338.7000

Europe
+ 33.3.22.54.13.90

Mexico/Latin America
+ 52.55.5809.5049

Middle East/Africa/India
+ 971.4.811.8100

United States
+ 1.800.621.1506

Appleton Group
9377 W. Higgins Road
Rosemont, IL 60018
1.800.621.1506
emerson.com



Appleton Grp LLC d/b/a Appleton Group. The Appleton and Emerson logos are registered in the U.S. Patent and Trademark Office. EasyHeat, Inc. is a wholly owned subsidiary of Appleton Grp LLC. All other product or service names are the property of their registered owners. © 2016, Appleton Grp LLC. All rights reserved. The Emerson logo is a trademark and a service mark of Emerson Electric Co. ©2016, Emerson Electric Co.



EMERSON. CONSIDER IT SOLVED.™