

5/2-directional valve, Series 519

- 5/2
- Qn = 175 l/min
- Pilot valve width : 15 mm
- Pipe connection
- Compressed air connection output : M5
- Electrical connection : Plug, EN 175301-803, form C
- Manual override : without detent
- single solenoid
- Air return with differential piston
- Pilot : Internal

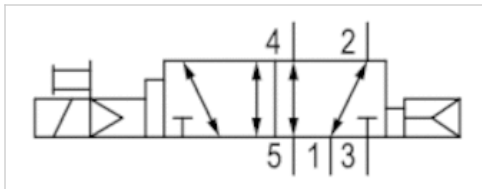

Type	Spool valve
Activation	Electrically
Pilot	Internal
Sealing principle	Soft sealing
Working pressure min./max.	1.5 ... 8 bar
Control pressure min./max.	1.5 ... 8 bar
Ambient temperature min./max.	5 ... 50 °C
Medium	Compressed air
Max. particle size	5 µm
Oil content of compressed air	0 ... 5 mg/m³
Nominal flow Qn	175 l/min
Connector standard	EN 175301-803
Protection class with connection	IP65
Duty cycle	100 %
Typ. switch-on time	20 ms
Typ. switch-off time	30 ms
mounting screws	M2.5 with slot
Weight	0.085 kg

Technical data

Part No.	Compressed air connection		Operational voltage
	Input	Output	
51900002	M5	M5	-
51900003	M5	M5	-
51900004	M5	M5	-
51900001	M5	M5	24 V

Part No.	Operational voltage	Power consumption	
		DC	AC 50 Hz
51900002	24 V	-	2 VA
51900003	110 V	-	2 VA
51900004	230 V	-	2 VA
51900001	-	1.6 W	-

Technical information

The min. control pressure must be adhered to, since otherwise faulty switching and valve failure may result!

The pressure dew point must be at least 15 °C under ambient and medium temperature and may not exceed 3 °C .

The oil content of compressed air must remain constant during the life cycle.

Use only the approved oils from AVENTICS. Further information can be found in the "Technical information" document (available in the MediaCentre).

Technical information

Material	
Housing	Aluminum, anodized
Seals	Nitrile butadiene rubber
Front plate	Polyoxymethylene
Threaded bushing	Aluminum

Dimensions

Dimensions

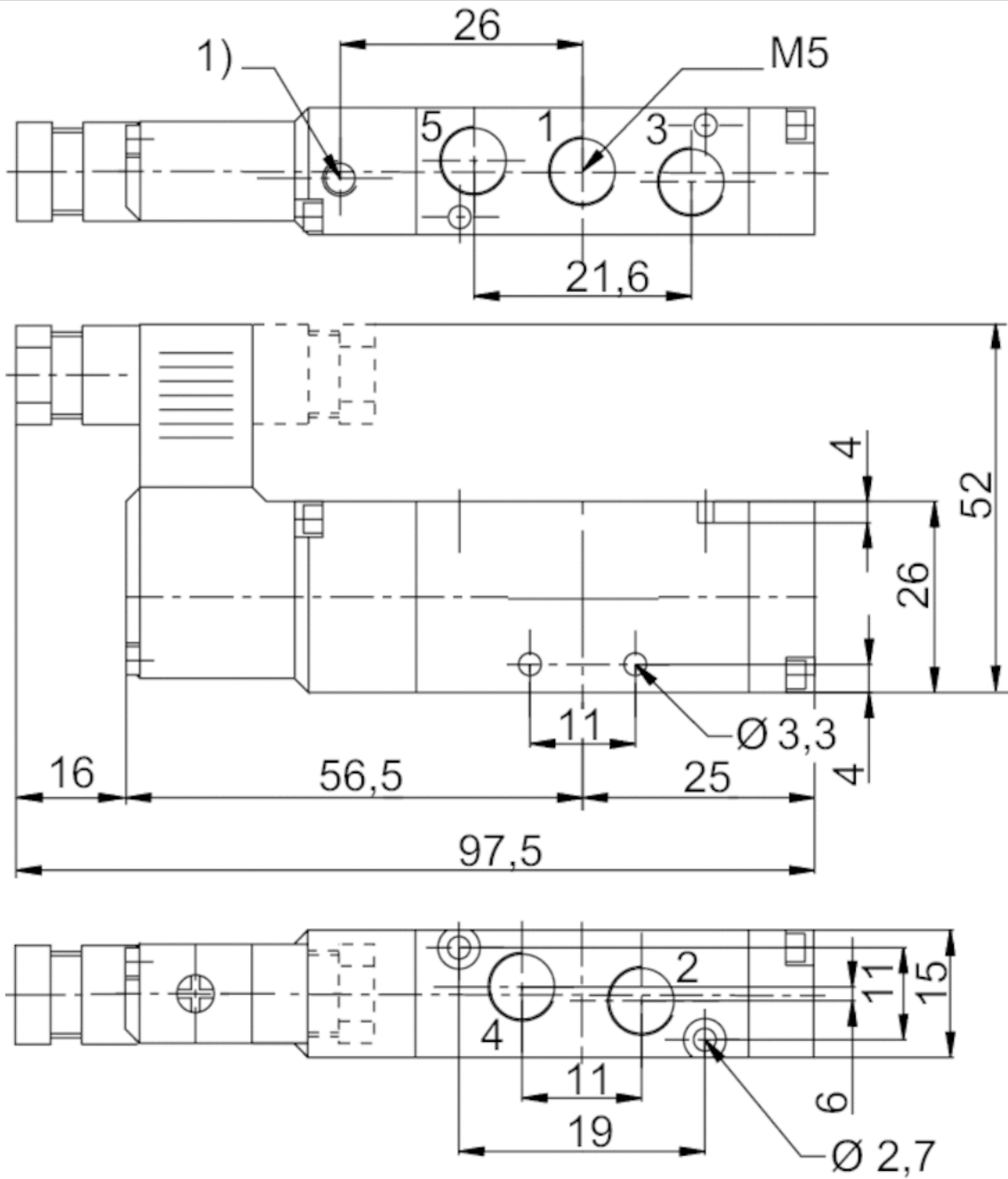

1) Pilot Exhaust

5/2-directional valve, Series 519

- 5/2
- Qn = 175 l/min
- Pilot valve width : 15 mm
- Pipe connection
- Compressed air connection output : M5
- Electrical connection : Plug, EN 175301-803, form C
- Manual override : without detent
- double solenoid
- Pilot : Internal

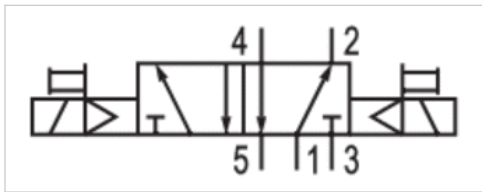

Type	Spool valve
Activation	Electrically
Pilot	Internal
Sealing principle	Soft sealing
Working pressure min./max.	1.5 ... 8 bar
Control pressure min./max.	1.5 ... 8 bar
Ambient temperature min./max.	5 ... 50 °C
Medium	Compressed air
Max. particle size	5 µm
Oil content of compressed air	0 ... 5 mg/m³
Nominal flow Qn	175 l/min
Connector standard	EN 175301-803
Protection class with connection	IP65
Duty cycle	100 %
Typ. switch-on time	20 ms
mounting screws	M2.5 with slot
Weight	0.135 kg

Technical data

Part No.	Compressed air connection		Operational voltage
	Input	Output	
51900006	M5	M5	-
51900007	M5	M5	-
51900008	M5	M5	-
51900005	M5	M5	24 V

Part No.	Operational voltage	Power consumption	
		DC	AC 50 Hz
51900006	24 V	-	2 VA
51900007	110 V	-	2 VA
51900008	230 V	-	2 VA
51900005	-	1.6 W	-

Technical information

The min. control pressure must be adhered to, since otherwise faulty switching and valve failure may result!

The pressure dew point must be at least 15 °C under ambient and medium temperature and may not exceed 3 °C .

The oil content of compressed air must remain constant during the life cycle.

Use only the approved oils from AVENTICS. Further information can be found in the "Technical information" document (available in the MediaCentre).

Technical information

Material	
Housing	Aluminum, anodized
Seals	Nitrile butadiene rubber
Front plate	Polyoxymethylene
Threaded bushing	Aluminum

Dimensions

Dimensions

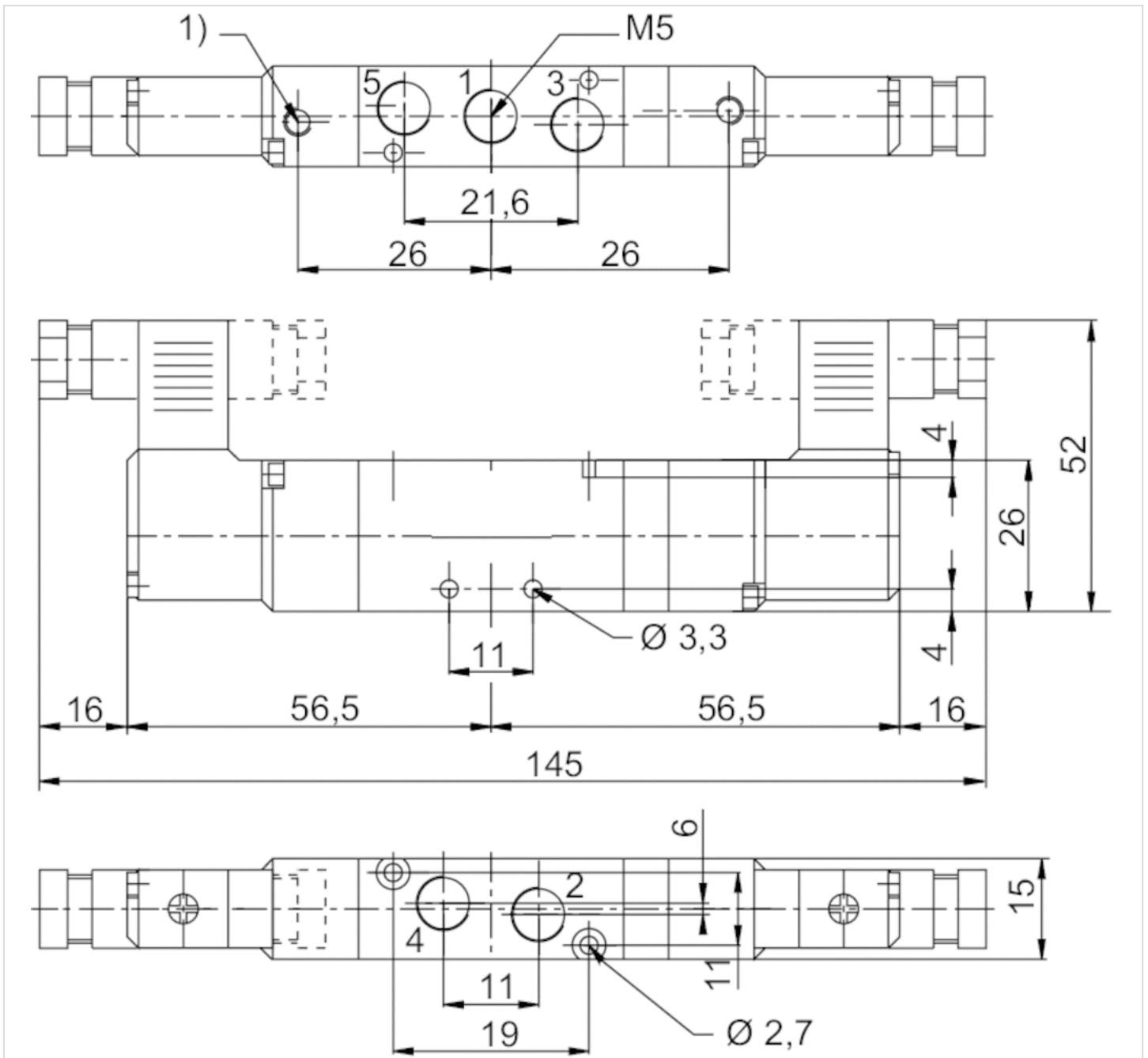

1) Pilot Exhaust







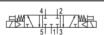
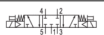

5/3-directional valve, Series 519

- 5/3
- Qn = 175 l/min
- Pilot valve width : 15 mm
- closed center pressurized center exhausted center
- Pipe connection
- Compressed air connection output : M5
- Electrical connection : Plug, EN 175301-803, form C
- Manual override : without detent
- double solenoid
- Pilot : Internal

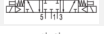
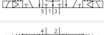
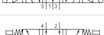

Type	Spool valve
Activation	Electrically
Pilot	Internal
Sealing principle	Soft sealing
Working pressure min./max.	1.5 ... 8 bar
Control pressure min./max.	1.5 ... 8 bar
Ambient temperature min./max.	5 ... 50 °C
Medium	Compressed air
Max. particle size	5 µm
Oil content of compressed air	0 ... 5 mg/m ³
Nominal flow Qn	175 l/min
Connector standard	EN 175301-803
Protection class with connection	IP65
Duty cycle	100 %
Typ. switch-on time	20 ms
Typ. switch-off time	50 ms
mounting screws	M2.5 with slot
Weight	0.14 kg

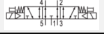
Technical data

Part No.			Compressed air connection	
				Input
51900010		closed center		M5
51900011		closed center		M5
51900012		closed center		M5
51900009		closed center		M5
51900126		pressurized center		M5
51900127		pressurized center		M5
51900128		pressurized center		M5
51900129		pressurized center		M5
51900087		exhausted center		M5
51900088		exhausted center		M5
51900089		exhausted center		M5
51900090		exhausted center		M5

Part No.	Compressed air connection	Operational voltage	Operational voltage
	Output		
51900010	M5	-	24 V
51900011	M5	-	110 V
51900012	M5	-	230 V
51900009	M5	24 V	-
51900126	M5	-	24 V
51900127	M5	-	110 V
51900128	M5	-	230 V
51900129	M5	24 V	-
51900087	M5	-	24 V
51900088	M5	-	110 V
51900089	M5	-	230 V
51900090	M5	24 V	-

Part No.	Power consumption	Switch-on power
	DC	AC 50 Hz
51900010	-	2 VA
51900011	-	2 VA
51900012	-	2 VA
51900009	1.6 W	-
51900126	-	2 VA
51900127	-	2 VA
51900128	-	2 VA
51900129	1.6 W	-
51900087	-	2 VA
51900088	-	2 VA
51900089	-	2 VA
51900090	1.6 W	-

Technical information

The min. control pressure must be adhered to, since otherwise faulty switching and valve failure may result!

The pressure dew point must be at least 15 °C under ambient and medium temperature and may not exceed 3 °C .

The oil content of compressed air must remain constant during the life cycle.

Use only the approved oils from AVENTICS. Further information can be found in the "Technical information" document (available in the MediaCentre).

Technical information

Material	
Housing	Aluminum, anodized
Seals	Nitrile butadiene rubber
Front plate	Polyoxymethylene
Threaded bushing	Aluminum

Dimensions

Dimensions

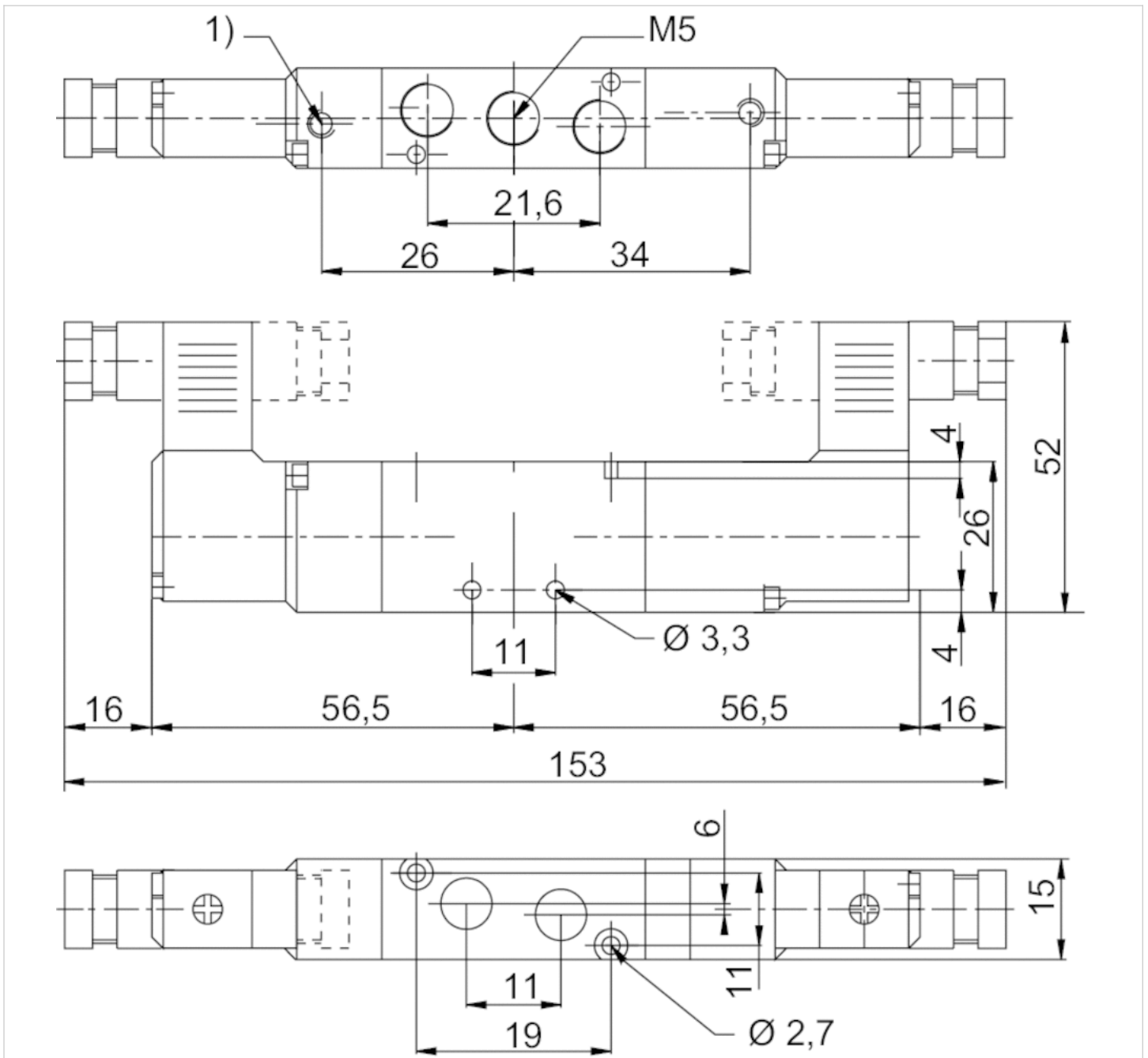

1) Pilot Exhaust

5/2-directional valve, Series 519

- Qn = 175 l/min
- Compressed air connection output M5
- Single air pilot
- With differential piston
- Pipe connection



Type	Spool valve
Activation	pneumatically
Pilot	External
Sealing principle	Soft sealing
Flow rate value Qn	175 l/min
Working pressure min./max.	1.5 ... 8 bar
Control pressure min./max.	1.5 ... 8 bar
Ambient temperature min./max.	5 ... 50 °C
Medium	Compressed air
Max. particle size	5 µm
Oil content of compressed air	0 ... 5 mg/m ³
Mounting screw	M3
Weight	0.05 kg

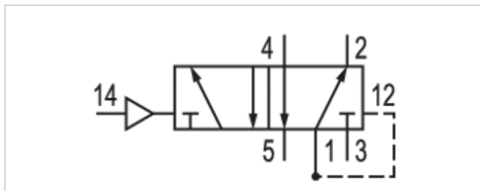

Technical data

Part No.	Compressed air connection	
	Input	Output
51900077	M5	M5

Technical information

The min. control pressure must be adhered to, since otherwise faulty switching and valve failure may result!
 The pressure dew point must be at least 15 °C under ambient and medium temperature and may not exceed 3 °C .
 The oil content of compressed air must remain constant during the life cycle.
 Use only the approved oils from AVENTICS. Further information can be found in the "Technical information" document (available in the MediaCentre).

Technical information

Material	
Housing	Aluminum, anodized
Seals	Nitrile butadiene rubber
Front plate	Polyoxymethylene
Threaded bushing	Aluminum

Dimensions

Dimensions

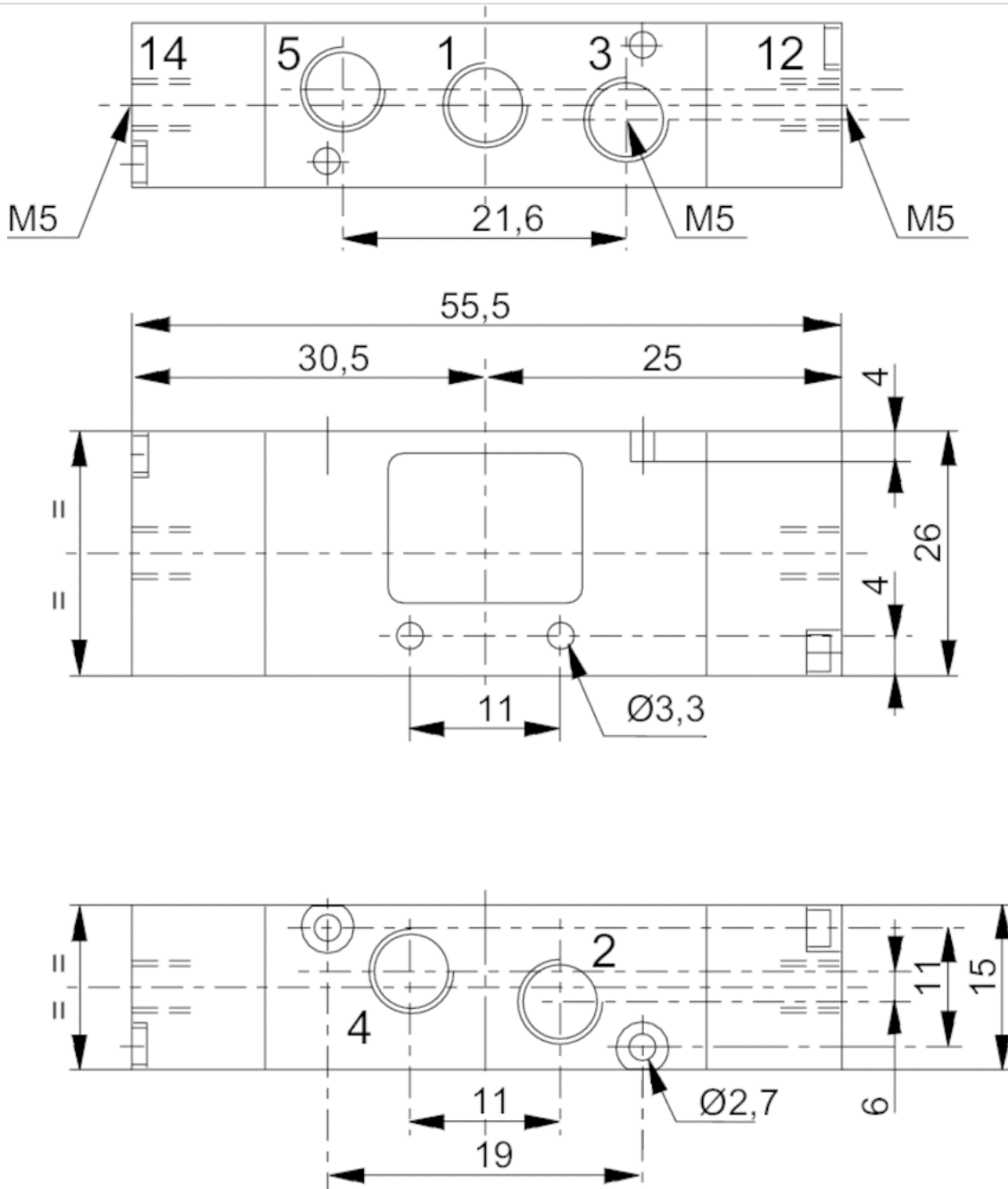

5/2-directional valve, Series 519

- Qn = 175 l/min
- Compressed air connection output M5
- double air pilot
- Pipe connection



Type	Spool valve
Activation	pneumatically
Pilot	External
Sealing principle	Soft sealing
Flow rate value Qn	175 l/min
Working pressure min./max.	0 ... 8 bar
Control pressure min./max.	1.5 ... 8 bar
Ambient temperature min./max.	5 ... 50 °C
Medium	Compressed air
Max. particle size	5 µm
Oil content of compressed air	0 ... 5 mg/m ³
Mounting screw	M3
Weight	0.05 kg

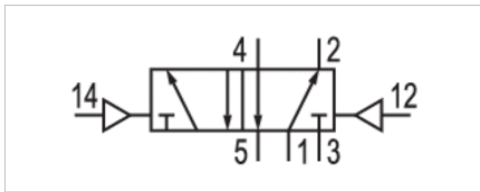

Technical data

Part No.	Compressed air connection	
	Input	Output
51900078	M5	M5

Technical information

The min. control pressure must be adhered to, since otherwise faulty switching and valve failure may result!

The pressure dew point must be at least 15 °C under ambient and medium temperature and may not exceed 3 °C .

The oil content of compressed air must remain constant during the life cycle.

Use only the approved oils from AVENTICS. Further information can be found in the "Technical information" document (available in the MediaCentre).

Technical information

Material	
Housing	Aluminum, anodized
Seals	Nitrile butadiene rubber
Front plate	Polyoxymethylene
Threaded bushing	Aluminum

Dimensions

Dimensions

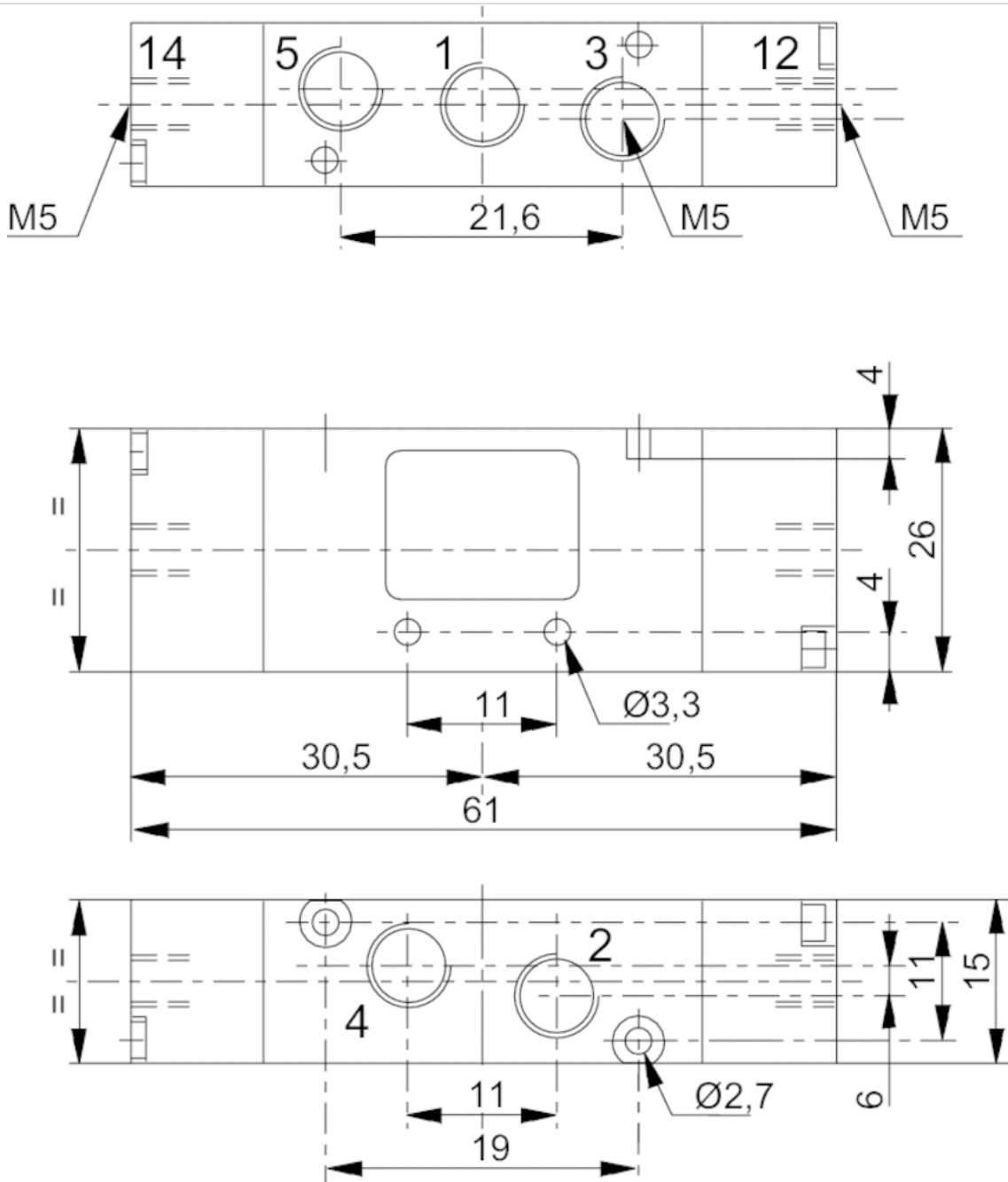

Series 355

- for 519



Weight

See table below

Technical data

Part No.	Suitable for Series	Scope of delivery	Port
35500324	aluminum base plates	Includes screws and seals.	M5
35500325	aluminum base plates	Includes screws and seals.	M5
35500326	aluminum base plates	Includes screws and seals.	M5
35500325	aluminum base plates	Includes screws and seals.	M5
35500328	aluminum base plates	Includes screws and seals.	M5
35500329	aluminum base plates	Includes screws and seals.	M5
35500330	aluminum base plates	Includes screws and seals.	M5
35500331	aluminum base plates	Includes screws and seals.	M5
35500332	aluminum base plates	Includes screws and seals.	M5

Part No.	Number of valve positions	Weight
35500324	2	0.105 kg
35500325	3	0.135 kg
35500326	4	0.165 kg
35500325	5	0.195 kg
35500328	6	0.225 kg
35500329	7	0.25 kg
35500330	8	0.28 kg
35500331	9	0.31 kg
35500332	10	0.34 kg

Technical information

The min. control pressure must be adhered to, since otherwise faulty switching and valve failure may result!

The pressure dew point must be at least 15 °C under ambient and medium temperature and may not exceed 3 °C .

The oil content of compressed air must remain constant during the life cycle.

Use only the approved oils from AVENTICS. Further information can be found in the "Technical information" document (available in the MediaCentre).

Technical information

Material

Base plate

Aluminum

Dimensions

Dimensions

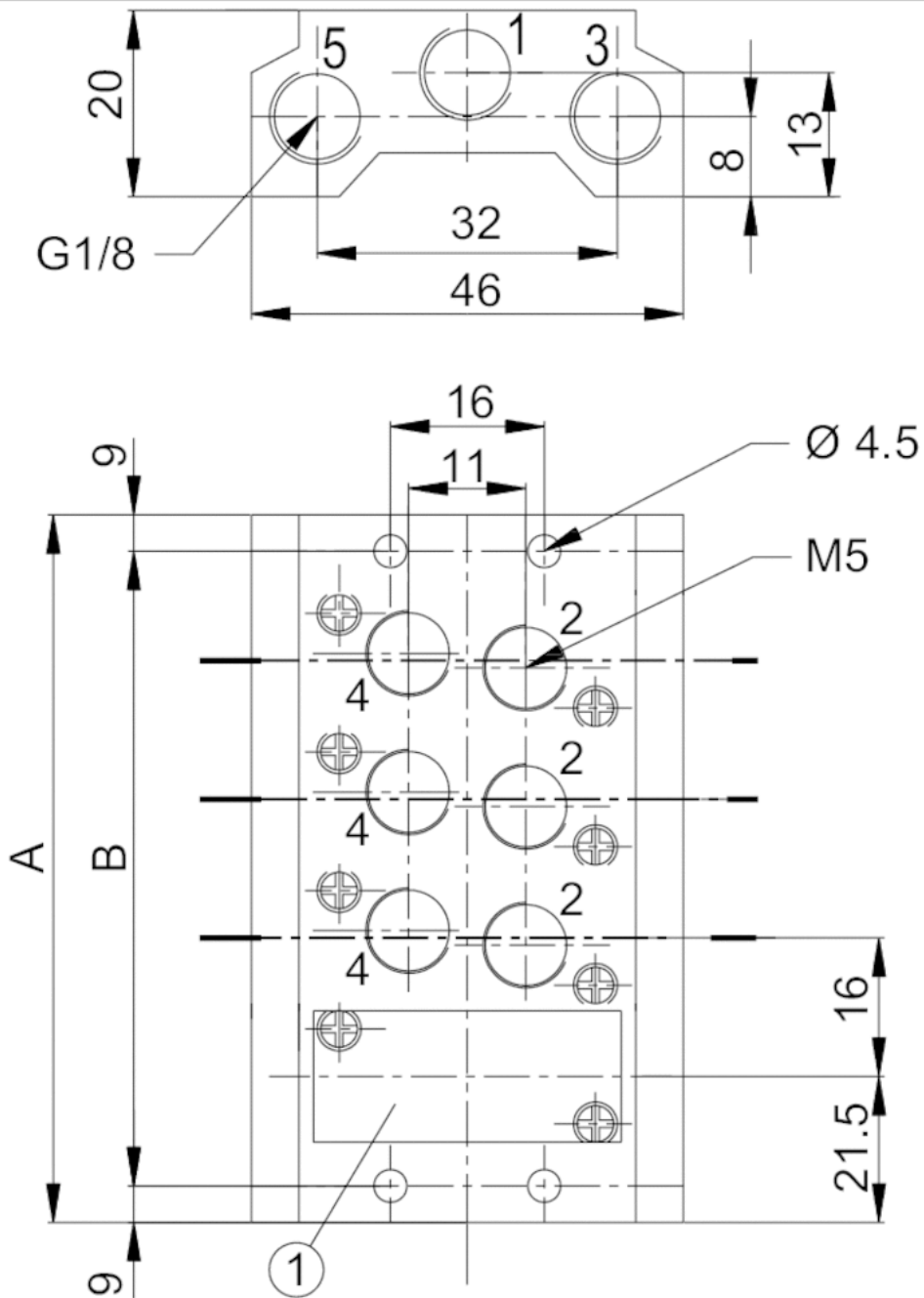

1) Blanking plate

Dimensions

Part No.	A	B
35500324	59	41
35500325	75	57
35500326	91	73
35500325	75	57
35500328	123	105
35500329	139	121
35500330	155	137
35500331	171	153
35500332	187	169

Efficient pneumatic solutions, our program: cylinders and drives, valves and valve systems, air supply management



Visit us: [Emerson.com/Aventics](https://www.emerson.com/Aventics)

Your local contact: [Emerson.com/contactus](https://www.emerson.com/contactus)



Emerson.com



[Facebook.com/EmersonAutomationSolutions](https://www.facebook.com/EmersonAutomationSolutions)



[LinkedIn.com/company/Emerson-Automation-Solutions](https://www.linkedin.com/company/Emerson-Automation-Solutions)



[Twitter.com/EMR_Automation](https://twitter.com/EMR_Automation)

An example configuration is depicted on the title page. The delivered product may thus vary from that in the illustration. Subject to change. This Document, as well as the data, specifications and other information set forth in it, are the exclusive property of AVENTICS GmbH. It may not be reproduced or given to third parties without its consent. Only use the AVENTICS products shown in industrial applications. Read the product documentation completely and carefully before using the product. Observe the applicable regulations and laws of the respective country. When integrating the product into applications, note the system manufacturer's specifications for safe use of the product. The data specified only serve to describe the product. No statements concerning a certain condition or suitability for a certain application can be derived from our information. The information given does not release the user from the obligation of own judgement and verification. It must be remembered that the products are subject to a natural process of wear and aging.

The Emerson logo is a trademark and service mark of Emerson Electric Co. Brand logotype are registered trademarks of one of the Emerson family of companies. All other marks are the property of their respective owners. © 2021 Emerson Electric Co. All rights reserved.
2022-11



CONSIDER IT SOLVED™