



## BIRKETT SAFEFLO SERIES SAFETY AND THERMAL RELIEF VALVES

A range of thermal relief valves for smaller gas or liquid applications, relieving thermal expansion of process fluids in vessels and long pipes



### FEATURES

- Wide choice of materials includes non-ferrous for low temperature and oxygen service and exotic alloys for the chemical and process industries.
- Simplified maintenance for flanged valves via a slip on inlet flange enabling easier realignment into existing pipework after servicing.
- Interchangeable parts enable easy modification from gas to liquid or liquid to gas with the minimum number of parts.
- D Series is certified for all media without modification.
- Proven dependability ensures safe and reliable performance.
- Optional cleaning for cryogenic and oxygen services available.
- Balanced piston available on the 7D Series to counter the effects of variable back pressure.

### GENERAL APPLICATION

Safeflo valves relieve excess pressure caused by thermal expansion in small capacity pumps, pipe work, tanks, calorifiers, gas and oil separators and long lengths of pipework. Models are available for gas, steam, vapor and liquid applications.

### TECHNICAL DATA

|                    |  |
|--------------------|--|
| Materials:         | Carbon steel, stainless steel                |
| Sizes:             | 1/2" x 1" to 1 1/2" x 2"<br>(DN 15 to DN 40) |
| Connections        |  |
| Threaded:          | 1/2" to 2"                                   |
| Flanged:           | 1/2" to 1 1/2"                               |
| Pressure range:    | 5 to 5000 psig<br>(0.35 to 345 barg)         |
| Temperature range: | -320° to 1000°F<br>(-196° to 538°C)          |

# BIRKETT SAFEFLO SERIES SAFETY AND THERMAL RELIEF VALVES

## OVERVIEW

---

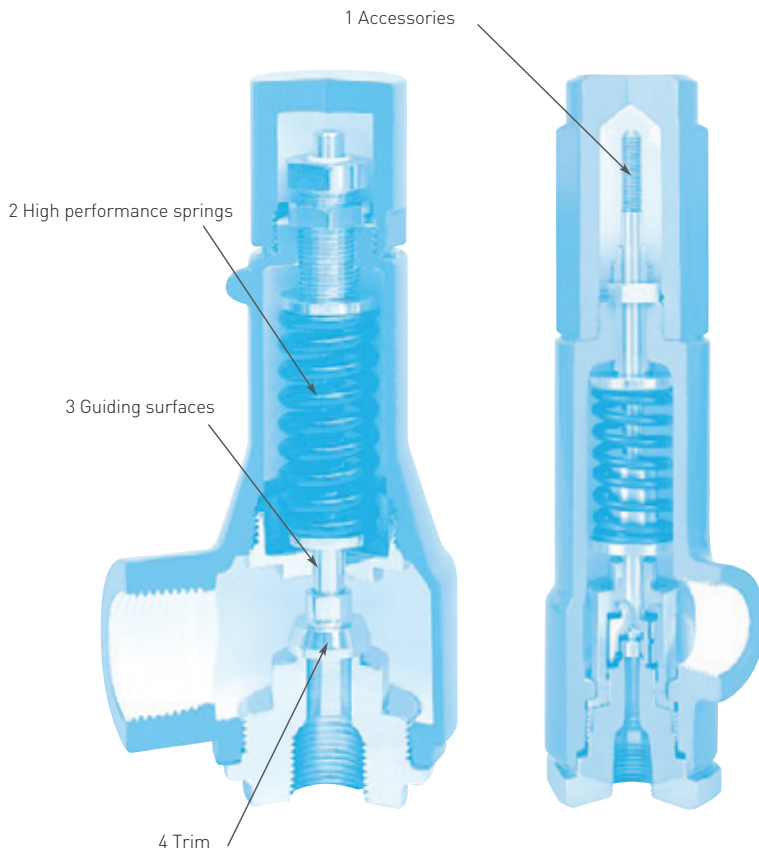

1. Wide range of accessories - available to comply with international codes and to suit system requirements.
2. High performance springs - safety relief valve springs are specially designed to guarantee set point repeatability.
3. Guiding surfaces - the material selection of guiding components, together with self-aligning disc pivot points, ensures correct alignment and no galling of guiding surfaces.
4. Trim - B/C Series valves have been designed with metal trim to give optimum performance at higher pressures. The 7D is available with a soft seat or metal seat, while the 6D is metal seated only.

### MODEL OPTIONS

---

Safeflo valves are available in three different valve types to suit differing service requirements:

B Series for gas/vapor duty.

C Series for liquid duty.

D Series for gas, liquid and steam duties.

### Standards and approvals

|                                   |                             |
|-----------------------------------|-----------------------------|
| Quality standard:                 | ISO 9001:2008               |
| Boiler and pressure vessels:      | ASME VIII<br>PED 97/23/EC   |
| Mechanical Engineering Directive: | ATEX 94/9/EC                |
| Sizing and selection:             | API 520: Part 1<br>ISO 4126 |
| Dimensions:                       | API 526                     |
| Leakage rates:                    | API 527                     |
| Flange ratings:                   | ANSI B16.5                  |

# BIRKETT SAFEFLO SERIES SAFETY AND THERMAL RELIEF VALVES

## OPERATION

### PRINCIPLE OF OPERATION

Safety relief valves use a spring force to hold a disc against a nozzle. Under normal system operating pressure, the valve will remain closed as the spring force is greater than the inlet system pressure force. The valve opens when the system pressure force becomes greater than the closing force of the spring.

Safeflo valves are designed to have a short simmer, open rapidly to full lift position and then re-seat at a controlled shut off pressure.

This is demonstrated in the graph below, which shows the valve action and corresponding pressure at the valve inlet.

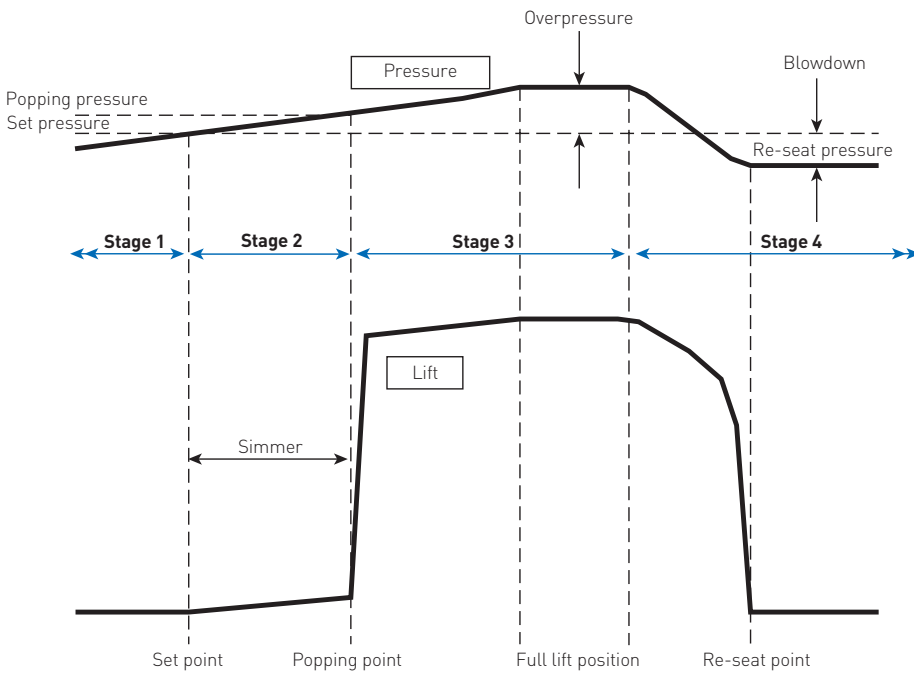
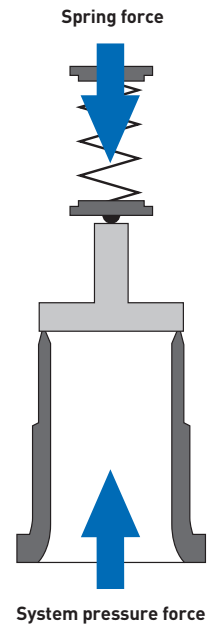

# BIRKETT SAFEFLO SERIES SAFETY AND THERMAL RELIEF VALVES

## OPERATION

### LIFT CYCLE

#### Stage 1 - Closed

Inlet pressure < set pressure

Inlet pressure is below the set pressure. The valve is closed and there is no flow through the valve.

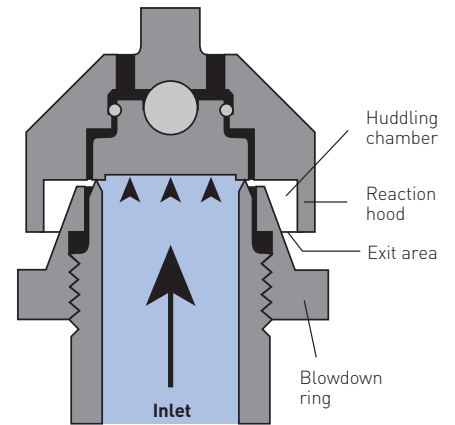

#### Stage 2 - Simmering

Inlet pressure is = > set pressure and < popping pressure

Inlet pressure increases to set pressure. At this point, the spring force and system pressure force are equal; a further rise in inlet pressure will then begin to lift the disc slightly. A small amount of fluid is released into the huddling chamber (the valve simmers). The system fluid is now acting on a larger area inside the huddling chamber.

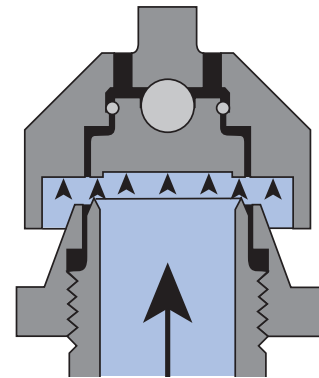

#### Stage 3 - Popping and opening

Inlet pressure = > popping pressure, valve fully open

The inlet pressure acting on a larger area produces a significant force to accelerate the opening. A combination of this pressure force, the kinetic energy from the fluid within the nozzle and the deflection force of the fluid flow turning through the reaction hood is transformed into disc lifting force. The valve pops open at < 5% overpressure and the valve reaches the full open position at 110% of set pressure, in accordance with international codes.

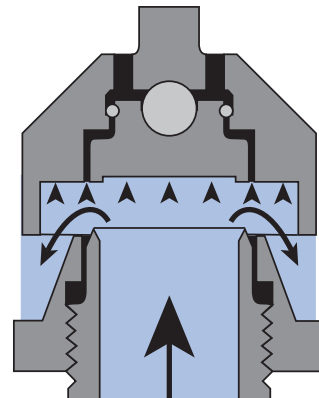

#### Stage 4 - Reseating

Inlet pressure falls to re-seating pressure

As system pressure starts to fall, the force from the spring begins to close the valve. Typically, the system pressure falls between 5-10% below the valve set pressure at which point the spring force accelerates the valve disc to re-seat the valve. The difference between the set pressure and the re-seating pressure is known as blowdown.

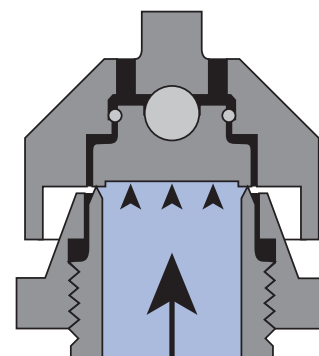

# BIRKETT SAFEFLO SERIES SAFETY AND THERMAL RELIEF VALVES

## B/C SERIES THERMAL RELIEF VALVES

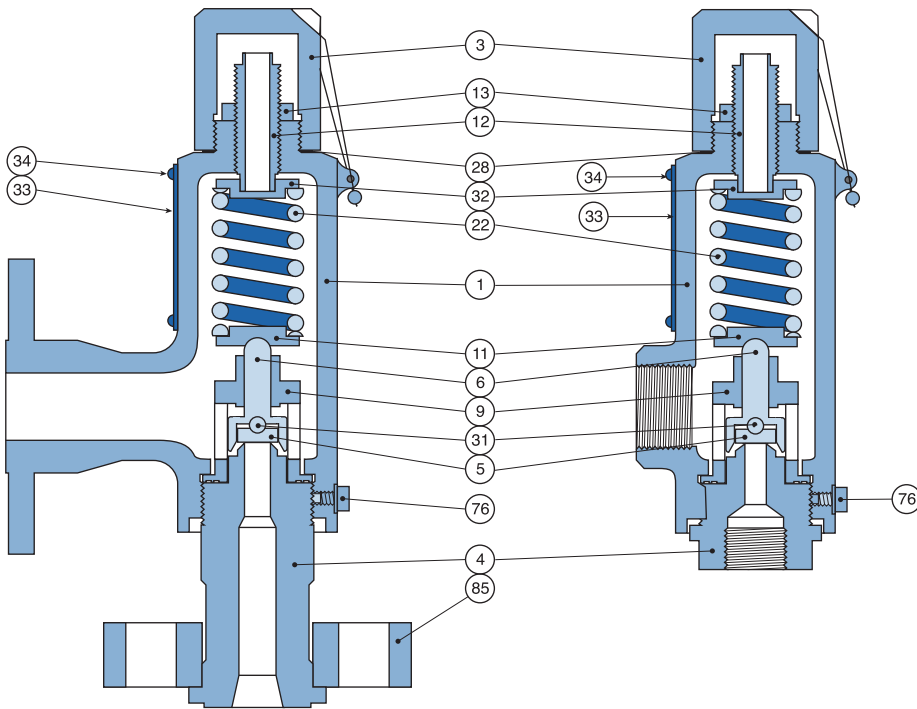

### PARTS LIST

| Item | Part               | Carbon steel         | Stainless steel    |
|------|--------------------|----------------------|--------------------|
| 1    | Body               | SA 216-WCB CARB ST   | SA 351-CF8M ST ST  |
| 3    | Cap                | ASTM A108-1021       | ASTM A479-316L     |
| 4*   | Nozzle             | 316 ST ST            | 316 ST ST          |
| 5*   | Disc               | 316 ST ST            | 316 ST ST          |
| 6*   | Disc holder        | SA564 17/4 [33HRC]   | SA564 17/4 [33HRC] |
| 9    | Guide              | SA351-CF8M ST ST     | SA351-CF8M ST ST   |
| 11   | Lower spring plate | ASTM A479-431        | ASTM A479-431      |
| 12   | Adjusting screw    | ASTM A479-410        | ASTM A479-410      |
| 13   | Locking nut        | ASTM A479-316L       | ASTM A479-316L     |
| 22*  | Spring             | C.S. Aluminum coated | ASTM A313-316      |
| 28*  | Cap gasket         | ST-706               | ST-706             |
| 31*  | Ball               | AISI 440C ST ST      | AISI 440C ST ST    |
| 32   | Upper spring plate | ASTM A479 431        | ASTM A479 431      |
| 33   | Data plate         | 321 ST ST            | 321 ST ST          |
| 34   | Hammer drive screw | Electro brassed CS   | ASTM A479-316L     |
| 76   | Capscrew           | ST ST BS6105 A2-70   | ST ST BS6105 A2-70 |
| 85   | Flange             | SA 105 CARB ST       | SA 182-F316 ST ST  |

\* Recommended spares

Cryogenic versions of the B and C Series are available

# BIRKETT SAFEFLO SERIES SAFETY AND THERMAL RELIEF VALVES

## DIMENSIONS - B/C SERIES THERMAL RELIEF VALVES

Female screwed

Male screwed

Flanged

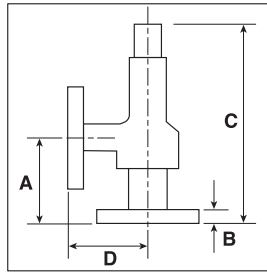
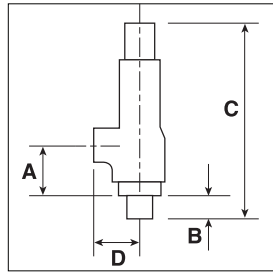
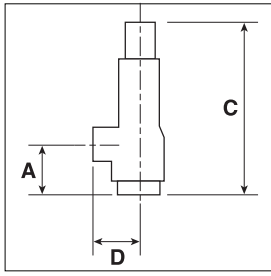

**NOTE**

A packed lever version and gagging facility are also available.

**DIMENSIONS**

| Sizes (ins)<br>inlet and outlet | Inlet and outlet<br>connection | Orifice<br>no.           | Dimensions ins (mm) |       |        |        | Max pressure up to 100°F (psig) |        | Weight<br>lbs (kg) |           |
|---------------------------------|--------------------------------|--------------------------|---------------------|-------|--------|--------|---------------------------------|--------|--------------------|-----------|
|                                 |                                |                          | A                   | B     | C*     | D      | Inlet                           | Outlet |                    |           |
| 1/2 x 1                         | Screwed female x<br>female     | 1                        | 2.500               | -     | 8.625  | 1.687  | 5000                            | 425    | 9 (4)              |           |
|                                 |                                | 2                        | (64)                | -     | (219)  | (43)   | 3600                            |        |                    |           |
| 3/4 x 1                         |                                | 1                        | 2.500               | -     | 8.625  | 1.687  | 5000                            | 425    | 9 (4)              |           |
|                                 |                                | 2                        | (64)                | -     | (219)  | (43)   | 3600                            |        |                    |           |
| 1 x 1                           |                                | 1                        | 2.500               | -     | 8.625  | 1.687  | 5000                            | 425    | 9 (4)              |           |
| 2                               |                                | (64)                     | -                   | (219) | (43)   | 3600   |                                 |        |                    |           |
| 1 x 1 1/2                       |                                | 3                        | 3.250               | -     | 13.750 | 2.375  | 5000                            | 425    | 26 (12)            |           |
| 1 1/2 x 2                       |                                | 4                        | 3.250               | -     | 13.750 | 2.375  | 2500                            | 375    | 26 (12)            |           |
| 1/2 x 1                         |                                | Screwed male x<br>female | 1                   | 2.562 | 0.750  | 9.375  | 1.687                           | 5000   | 425                | 9 (4)     |
|                                 |                                |                          | 2                   | (65)  | (19)   | (238)  | (43)                            | 3600   |                    |           |
| 3/4 x 1                         | 1                              |                          | 2.562               | 0.750 | 9.375  | 1.687  | 5000                            | 425    | 9 (4)              |           |
|                                 | 2                              |                          | (65)                | (19)  | (238)  | (43)   | 3600                            |        |                    |           |
| 1 x 1                           | 1                              |                          | 2.312               | 1.000 | 9.375  | 1.687  | 5000                            | 425    | 9 (4)              |           |
| 2                               | (59)                           |                          | (25)                | (238) | (43)   | 3600   |                                 |        |                    |           |
| 1 x 1 1/2                       | 3                              |                          | 3.250               | 1.000 | 14.750 | 2.375  | 3000                            | 425    | 26 (12)            |           |
| 1 1/2 x 2                       | 4                              |                          | 3.250               | 1.125 | 14.875 | 2.375  | 2500                            | 375    | 26 (12)            |           |
| 3/4 x 1, 1 x 1                  | 150# x 150#                    |                          | 1 + 2               | 4.625 | 1.000  | 10.250 | 3.750                           | 285    | 285                | 17 (7.25) |
| 1/2 x 1, 3/4 x 1, 1 x 1         | 300/600# x 150#                |                          | 1 + 2               | 4.625 | 1.375  | 10.250 | 3.750                           | 1480   | **285              | 17 (7.25) |
| 1/2 x 1, 3/4 x 1, 1 x 1         | 900/1500# x 300#               | 1 + 2                    | 4.625               | 1.187 | 10.375 | 3.750  | 3600                            | 425    | 20 (9)             |           |
| 3/4 x 1, 1 x 1                  | 2500# x 300#                   | 1                        | 4.750               | 2.000 | 10.500 | 5.500  | 5000                            | 425    | 20 (9)             |           |
|                                 |                                | 2                        | (121)               | (51)  | (267)  | (140)  | 3600                            |        |                    |           |
| 1 x 1 1/2                       | 150# x 150                     | 3                        | 5.625               | 1.000 | 16.750 | 5.500  | 285                             | 285    | 40 (18)            |           |
| 1 x 1 1/2                       | 300/600# x 150#                | 3                        | 5.625               | 1.375 | 16.750 | 5.500  | 1480                            | **285  | 40 (18)            |           |
| 1 x 1 1/2                       | 900/1500# x 300#               | 3                        | 5.625               | 1.812 | 16.750 | 5.500  | 3600                            | 425    | 40 (18)            |           |
| 1 x 1 1/2                       | 2500# x 300#                   | 3                        | 5.625               | 2.000 | 16.750 | 5.500  | 5000                            | 425    | 40 (18)            |           |

- \* If a gag screw is fitted, add 2 ins (51 mm) to dimension C for orifice nos. 1 and 2 only.
- \* If a packed lever is fitted, add 1 1/4 ins (44 mm) to dimension C for orifice nos. 1 and 2 only.
- \*\* 425 psig with 300# outlet

**Minimum set pressure**

B Series (gas) = 10 psig (0.7 barg)  
 C Series (liquid) = 15 psig (1.035 barg)  
 Orifice no.1 = 1480 psig (102 barg)

**Temperature range** (with suitable material selection)

-320°F to 1000°F [-196°C to 538°C]

**Orifice sizes**

Refer to Technical Data Sheet reference VCTDS-03794

# BIRKETT SAFEFLO SERIES SAFETY AND THERMAL RELIEF VALVES

## D SERIES THERMAL RELIEF VALVES

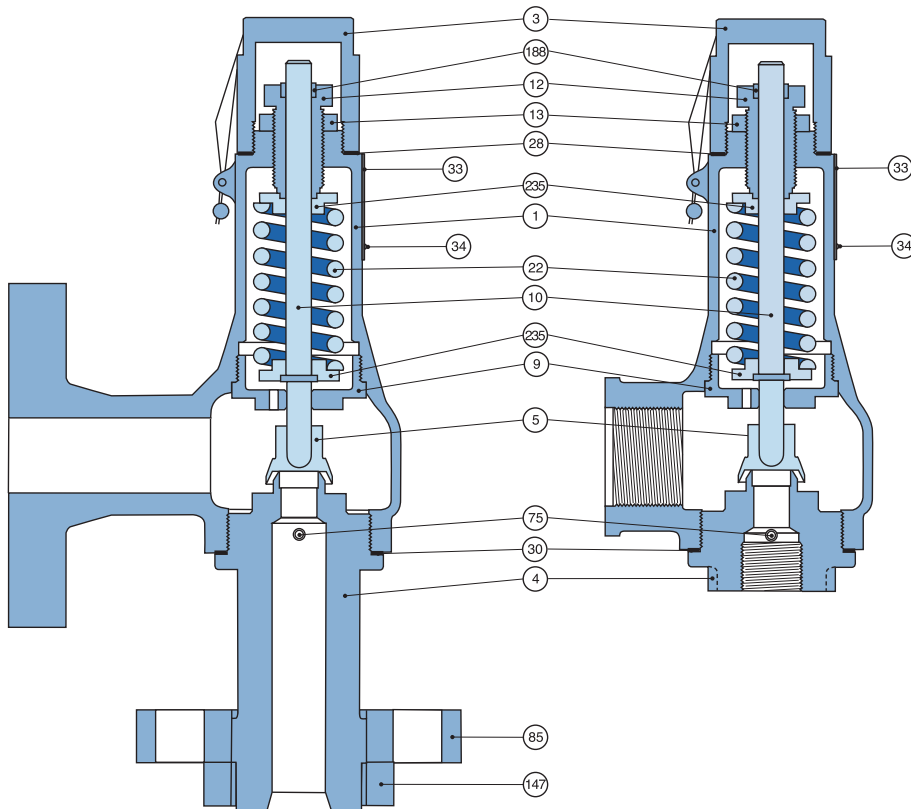

### PARTS LIST

| Item | Part                 | Carbon steel         | Stainless steel    |
|------|----------------------|----------------------|--------------------|
| 1    | Body                 | SA 216-WCB CARB ST   | SA 351-CF8M ST ST  |
| 3    | Cap                  | SA 216-WCB CARB ST   | SA 351-CF8M ST ST  |
| 4*   | Nozzle               | 316 ST ST            | 316 ST ST          |
| 5*   | Disc                 | 316 ST ST            | 316 ST ST          |
| 9    | Guide                | 17/4 PH ST ST        | 17/4 PH ST ST      |
| 10   | Spindle              | 316 ST ST            | 316 ST ST          |
| 12   | Adjusting screw      | ASTM A479-410        | ASTM A479-410      |
| 13   | Locking nut          | ASTM A479-316L       | ASTM A479-316L     |
| 22*  | Spring               | C.S. Aluminum coated | ASTM A313-316      |
| 28*  | Cap gasket           | ST-706               | ST-706             |
| 30   | Body gasket          | ST-706               | ST-706             |
| 33   | Data plate           | 321 ST ST            | 321 ST ST          |
| 34   | Hammer drive screw   | Electro brassed CS.  | ASTM A479-316L     |
| 75   | Grub screw           | ASTM A479-316L       | ASTM A479-316L     |
| 85   | Inlet flange         | SA 105 CARB ST       | SA 182-F316 ST ST  |
| 147  | Flange nut           | SA564 17/4 (33HRC)   | SA564 17/4 (33HRC) |
| 188  | Adjusting screw bush | Virgin PTFE          | Virgin PTFE        |
| 235  | Spring end plate     | ASTM A479-431        | ASTM A479-431      |

\* Recommended spares

# BIRKETT SAFEFLO SERIES SAFETY AND THERMAL RELIEF VALVES

## DIMENSIONS - D SERIES THERMAL RELIEF VALVES

Female screwed

Male screwed

Flanged

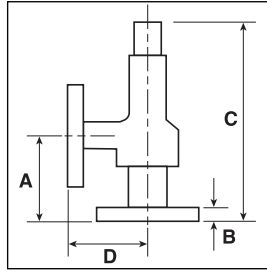
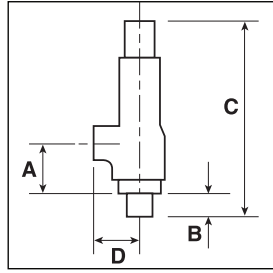
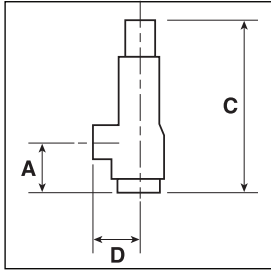

**NOTE**

A packed lever version and gagging facility are also available.

**DIMENSIONS**

| Sizes (ins)<br>inlet and outlet | Inlet and outlet<br>connection | Orifice<br>no. | Dimensions ins (mm) |               |                 |               | Max pressure up to 100°F (psig) |        | Weight<br>lbs (kg) |
|---------------------------------|--------------------------------|----------------|---------------------|---------------|-----------------|---------------|---------------------------------|--------|--------------------|
|                                 |                                |                | A                   | B             | C*              | D             | Inlet                           | Outlet |                    |
| 1/2 x 1, 3/4 x 1, 1 x 1         | Screwed female x<br>female     | 6              | 1.732<br>(64)       | -             | 7.440<br>(189)  | 2.165<br>(55) | 1480                            | 285    | 9 (4)              |
|                                 | Screwed male x<br>female       | 6              | 1.732<br>(43)       | 0.750<br>(19) | 8.230<br>(209)  | 2.165<br>(55) | 1480                            | 285    | 9 (4)              |
| 3/4 x 1, 1 x 1                  | ANSI 600# x 150#               | 6              | 4.610<br>(117)      | 1.625<br>(41) | 10.315<br>(262) | 3.750<br>(95) | 1480                            | 285    | 14 (6.5)           |
| 1/2 x 1, 3/4 x 1, 1 x 1         | Screwed female x<br>female     | 7              | 1.732<br>(44)       | -             | 7.440<br>(189)  | 2.165<br>(55) | 740                             | 285    | 9 (4)              |
|                                 | Screwed male x<br>female       | 7              | 1.687<br>(43)       | 0.750<br>(19) | 8.230<br>(209)  | 2.165<br>(55) | 740                             | 285    | 9 (4)              |
| 3/4 x 1, 1 x 1                  | ANSI 150# x 150#               | 7              | 4.625<br>(117)      | 1.187<br>(46) | 10.375<br>(264) | 3.750<br>(95) | 285                             | 285    | 14 (6.5)           |
|                                 | ANSI 300# x 150#               |                | 740                 |               |                 |               |                                 |        |                    |

\* If a packed lever is fitted, add 1.062 ins (27 mm) to dimension C for orifice 7 only.  
 If a gag screw is fitted, add 0.395 ins (10 mm) to dimension C for orifice 7 only.  
 If a balanced piston is fitted, add 2.125 ins (54 mm) to dimension C for orifice 7 only.  
 If a gagged balanced piston is fitted, add 2.520 ins (64 mm) to dimension C for orifice 7 only.

**Orifice sizes**

Refer to Technical Data Sheet reference VCTDS-03794

**Minimum set pressure**

7D (gas, steam or liquid) = 5 psig (0.35 barg)  
 6D (gas, steam or liquid) = 740 psig (51 barg)

**Temperature range (with suitable material selection)**

6D and 7D -51°F to 500°F (-46°C to 260°C)



# BIRKETT SAFEFLO SERIES SAFETY AND THERMAL RELIEF VALVES

## ACCESSORIES

### Packed lever

The design of the packed lever assembly ensures that leakage does not occur when the valve is open or when back pressure is present.

PACKED LEVER

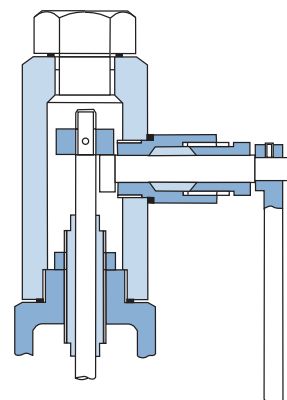

### Balanced piston

This option is designed to overcome the effects of variable back pressure and is only available on the 7D Series valves.

BALANCED PISTON

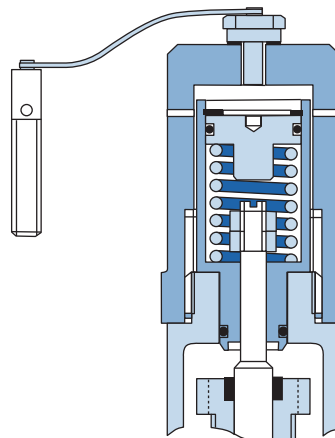

### Test gag

The test gag is used to prevent the safety valve from lifting and is used mainly when carrying out a hydrostatic test on the system, during commissioning.

After testing, the test gag must be removed and replaced with the sealing plug.

TEST GAG

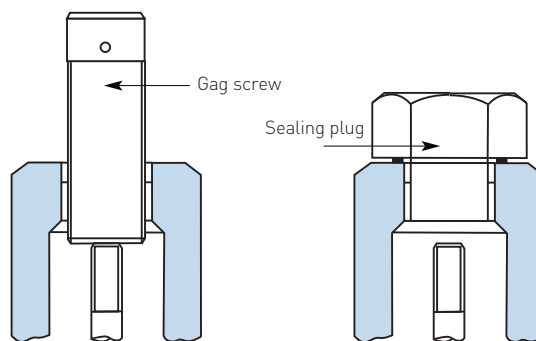

# BIRKETT SAFEFLO SERIES SAFETY AND THERMAL RELIEF VALVES

## SELECTION

### SELECTION GUIDE

| Example:                               |                                 | 2 | B | 2 | C                                 | F | 1 | A | 2 | C |
|--|---------------------------------|---|---|---|-----------------------------------|---|---|---|---|---|
| <b>Orifice area (in<sup>2</sup>)</b>   |                                 |   |   |   |                                   |   |   |   |   |   |
| 1                                      | 0.062**                         |   |   | 4 | 0.442**                           |   |   |   |   |   |
| 2                                      | 0.110**                         |   |   | 6 | 0.070*                            |   |   |   |   |   |
| 3                                      | 0.196**                         |   |   | 7 | 0.169*                            |   |   |   |   |   |
| <b>Valve series</b>                    |                                 |   |   |   |                                   |   |   |   |   |   |
| B                                      | Gas vapor                       |   |   |   |                                   |   |   |   |   |   |
| C                                      | Liquid                          |   |   |   |                                   |   |   |   |   |   |
| D                                      | Gas, steam and liquid           |   |   |   |                                   |   |   |   |   |   |
| <b>Connection size</b>                 |                                 |   |   |   |                                   |   |   |   |   |   |
| 1                                      | ½" x 1" orifice 1, 2, 6 or 7    |   |   | 4 | 1½" x 2" orifice 4 - screwed only |   |   |   |   |   |
| 2                                      | ¾" x 1" orifice 1, 2, 6 or 7    |   |   | 5 | 1" x 1" orifice 1, 2, 6 or 7      |   |   |   |   |   |
| 3                                      | 1" x 1½" orifice 3              |   |   |   |                                   |   |   |   |   |   |
| <b>Inlet connection type</b>           |                                 |   |   |   |                                   |   |   |   |   |   |
| A                                      | BSP Tr male screwed             |   |   | 1 | ANSI 300/600 RF flange            |   |   |   |   |   |
| B                                      | BSP female screwed              |   |   | 2 | ANSI 900/1500 RF flange**         |   |   |   |   |   |
| C                                      | API male screwed                |   |   | 3 | ANSI 2500 RF flange**             |   |   |   |   |   |
| D                                      | API female screwed              |   |   | 7 | ANSI 150 RF flange                |   |   |   |   |   |
| O                                      | Special**                       |   |   |   |                                   |   |   |   |   |   |
| <b>Outlet connection type</b>          |                                 |   |   |   |                                   |   |   |   |   |   |
| E                                      | BSP female screwed              |   |   |   |                                   |   |   |   |   |   |
| F                                      | API female screwed              |   |   |   |                                   |   |   |   |   |   |
| 1                                      | ANSI 150 RF flange              |   |   |   |                                   |   |   |   |   |   |
| 2                                      | ANSI 300 RF flange**            |   |   |   |                                   |   |   |   |   |   |
| O                                      | Special**                       |   |   |   |                                   |   |   |   |   |   |
| <b>Body material</b>                   |                                 |   |   |   |                                   |   |   |   |   |   |
| 1                                      | Carbon steel WCB                |   |   | 4 | Stainless steel CF8M              |   |   |   |   |   |
| 2                                      | Carbon steel WCB NACE           |   |   | O | Special**                         |   |   |   |   |   |
| 3                                      | Stainless steel CF8M NACE       |   |   |   |                                   |   |   |   |   |   |
| <b>Spring material</b>                 |                                 |   |   |   |                                   |   |   |   |   |   |
| A                                      | Aluminum coated CS              |   |   | T | Aluminum coated tungsten          |   |   |   |   |   |
| 2                                      | Stainless steel 316             |   |   | Z | Inconel X750                      |   |   |   |   |   |
| 6                                      | Tungsten alloy                  |   |   | O | Special**                         |   |   |   |   |   |
| 9                                      | Hastelloy B**                   |   |   |   |                                   |   |   |   |   |   |
| <b>Trim - nozzle and disc material</b> |                                 |   |   |   |                                   |   |   |   |   |   |
| 1                                      | Stainless steel PH 17/4         |   |   | 6 | Monel 400**                       |   |   |   |   |   |
| 2                                      | Stainless steel 316             |   |   | 7 | Stainless steel 304**             |   |   |   |   |   |
| 4                                      | Hastelloy B**                   |   |   | O | Special**                         |   |   |   |   |   |
| 5                                      | Stainless steel 316 stellited** |   |   |   |                                   |   |   |   |   |   |
| <b>Accessories</b>                     |                                 |   |   |   |                                   |   |   |   |   |   |
| C                                      | Screwed cap                     |   |   | S | Special feature                   |   |   |   |   |   |
| P                                      | Packed lever                    |   |   | B | Balanced piston❖                  |   |   |   |   |   |
| G                                      | Test gag                        |   |   | R | Soft seat❖                        |   |   |   |   |   |
| F                                      | Ferrule (Government ring)       |   |   |   |                                   |   |   |   |   |   |

\* Available on D Series only.

\*\* Not available on D Series.

❖ Available on 7D only.

Neither Emerson, Emerson Automation Solutions, nor any of their affiliated entities assumes responsibility for the selection, use or maintenance of any product. Responsibility for proper selection, use, and maintenance of any product remains solely with the purchaser and end user.

Emerson Automation Solutions, Emerson and the Emerson logo are trademarks and service marks of Emerson Electric Co. All other marks are the property of their respective owners.

The contents of this publication are presented for informational purposes only, and while every effort has been made to ensure their accuracy, they are not to be construed as warranties or guarantees, express or implied, regarding the products or services described herein or their use or applicability. All sales are governed by our terms and conditions, which are available upon request. We reserve the right to modify or improve the designs or specifications of such products at any time without notice.

Emerson.com/FinalControl