

ASCO™ Spool Valves

single/dual solenoid - pilot operated or air operated - stainless steel body - 1/4 and 1/2 tapped

5/2
SERIES
551 - 553

Features

- The monostable spool valves in conformity with IEC 61508 Standard (2010 route 2_H version) have TÜV (551 series) and EXIDA (551-553 series) certified with integrity levels: SIL 2 for HFT = 0 / SIL 3 for HFT = 1
- Series 551 versions according to ATEX 2014/34/EU, for zones 0, 1 and 2 and series 553 air-operated versions for zones 1 and 2
- All the exhaust ports of the spool valve are connectable, providing better environmental protection. Particularly recommended for sensitive areas, such as clean rooms, and applications in the pharmaceutical and food processing sectors
- The valves offer environmental protection against the ingress of liquids, dusts or other foreign matter (environmentally-protected construction)
- The solenoid valves satisfy all relevant EU directives

General

Differential pressure 2 - 10,4 bar [1 bar = 100 kPa]
Flow (Q_v at 6 bar) 1/4 = 860 l/min (ANR)
1/2 = 3000 l/min

fluids (*)	temperature range (TS)	seal materials (*)
air, inert gas, filtered	551: -40°C to +80°C	VMQ (silicone) + PUR (polyurethane)
	553: -40°C to +60°C	

Materials in contact with fluid

(*) Ensure that the compatibility of the fluids in contact with the materials is verified

	Air operated	CNOMO solenoid (pilot)
interface	(551-553 Series) Stainless steel, AISI 316L	(551 Series) Stainless steel, AISI 316L
Body, end covers	Stainless steel, POM	Stainless steel, POM
Spool valve internal parts	NBR	NBR
Seals	-	Size 30 (E06.05.80N), refer to catalogue pages: 314/LPKF pilot (contact us) and 195 pilot (LISC)
Pilot internal parts	-	

Air operated specifications

pipe size	orifice size	flow coefficient Kv		operating pressure differential (bar)		prefix optional	basic catalogue number
		(m ³ /h)	(l/min)	min.	max. (PS) air (*)		
(*)	(mm)	(m ³ /h)	(l/min)				
Pilot air operated - spring return (monostable)							
1/4	6	0,75	12,5	2	10	-	❖551A121 ⁽¹⁾
1/2	13	2,49	41,5	2	10	-	❖553A121 ⁽¹⁾
Pilot air operated and return (bistable)							
1/4	6	0,75	12,5	2	10	-	❖551A122
1/2	13	2,49	41,5	2	10	-	❖553A122

CNOMO solenoid (pilot) interface specifications

pipe size	orifice size	flow coefficient Kv		operating pressure differential (bar)		power level	prefix optional solenoids		basic catalogue number
		(m ³ /h)	(l/min)	min.	max. (PS) air (*)		ATEX / IECEx		
(*)	(mm)	(m ³ /h)	(l/min)			~/=	Ex db	Ex ia	
				~	=		(2)	LISC	
Solenoid air pilot operated - spring return (monostable)									
1/4	6	0,75	12,5	2	10	10	BP	●	❖551A221 ⁽¹⁾
1/4	6	0,75	12,5	2	-	8	LP	○	❖551B221 ⁽¹⁾
Solenoid air pilot operated and return (bistable)									
1/4	6	0,75	12,5	2	10	10	BP	●	❖551A222
1/4	6	0,75	12,5	2	-	8	LP	○	❖551B222

❖ Select 8 for NPT ANSI 1.20.3 or select G for ISO G (228/1) ● Available feature ○ Available feature in DC only. - Not available
⁽¹⁾ Certified IEC 61508 Functional Safety data, use suffix "SL".
⁽²⁾ 314/LPKF: Contact us

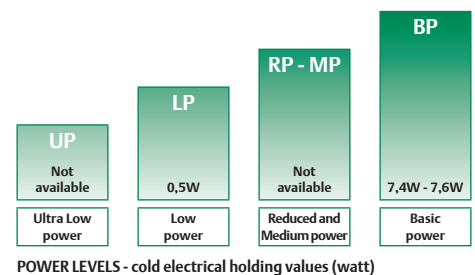
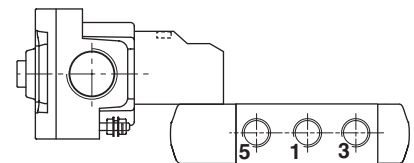
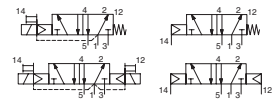

Prefix table

prefix							description	power level			
1	2	3	4	5	6	7		UP	LP	RP	BP
L	I	S	C				Intrinsically safe - 195 pilot (EN/IEC 60079-11)*	-	-	-	●

Suffix table

suffix							description	power level			
1	2	3	4	5	6	7		UP	LP	RP	BP
	G	D					Non-electrical - 1 GD c (551)/ 2 GD c (553) - (EN 13463-5) Screw type manual operator ⁽³⁾ Certified IEC 61508 Functional Safety data ⁽¹⁾	-	-	-	-
			M	S				-	-	-	●
	S	L						-	○	-	●

Options & Accessories

series	pipe size	exhaust protector (stainless steel)	
		G	NPT
551	1/8	34600418 ⁽²⁾	34600482 ⁽²⁾
551	1/4	34600419 ⁽²⁾	34600483 ⁽²⁾
553	1/2	34600479 ⁽²⁾	34600479 ⁽²⁾

- Available feature
- Available feature in DC only
- Not available
- * ATEX/IECEx valves using these solenoids are approved according to EN ISO 80079-36 (2016) and EN ISO 80079-37 (2016) [non electrical]
- ⁽¹⁾ Not to use with MS suffix
- ⁽²⁾ Provided with "SL" suffix
- ⁽³⁾ Not to use with LISC prefix
- ⁽⁴⁾ 314/LPKF: Contact us

Product selection guide

STEP 1

Select basic catalogue number, including pipe thread indentification letter. Refer to the specifications table on page: 1
Example: G551B221

STEP 2

Select prefix (combination). Refer to the specifications table and the prefix table, respect the indicated power level.
Air operated version, does not use prefix.
Example: LISC

STEP 3

Select suffix (combination) if required. Refer to the suffix table, respect the indicated power level.
GD suffix available for air operated version only (do not use manual operator suffix).
Example: -

STEP 4

Select voltage. Refer to standard voltages on page: 3
Example: 12..24 V

STEP 5

Final catalogue / ordering number
Example: LISC G551B221 12..24 V

Ordering examples valves:

	LISC	G	551 B 221	12..24V / DC
	LISC	G	551 B 222	12..24V / DC
		G	551 A 121	
		G	551 A 121	GD
		G	551 A 121	GDSL
		G	551 A 122	
		G	553 A 121	
		G	551 A 122	GD

Explanation of temperature ranges of solenoid valves

Valve temperature range	The valve temperature range (TS) is determined by the selected seal material, the temperature range for proper operation of the valve and sometimes by the fluid (e.g. steam)
Operator ambient temperature range	The operator ambient temperature range is determined by the selected power level and the safety code
Total temperature range	The temperature range of the complete solenoid valve is determined by the limitations of both temperature ranges above

Electrical characteristics

Coil insulation class	F
Electrical safety	IEC 335
Standard voltages	DC (=) ⁽⁵⁾ : 24V - 48V ; LISC: 12..24V AC (~) ⁽⁵⁾ : 24V - 48V - 115V - 230V/50Hz - other voltages and 60Hz are available on request

prefix option	power ratings				operator ambient temperature range (TS) (°C)	safety code	electrical enclosure protection (EN 60529)	replacement coil		type ⁽¹⁾
	inrush ~ (VA)	holding ~ (VA)	hot/cold = (W)	hot/cold = (W)				~ -	= -	
Basic power (BP)										
⁽⁵⁾	8,6	1,6	7,4	6/7,6	-25 to +80	II2G Ex d IIB+H2 Gb T4, II2D Ex tb IIIC Db	IP65, alu.	-	-	01
Low Power (LP)										
LISC ⁽³⁾⁽⁴⁾	-	-	-	0,5	-40 to +65	II 1G Ex ia IIC T6 Ga, II 2D Ex ib IIIC Db ⁽³⁾	IP65, moulded	-	-	02

- Not available

⁽¹⁾ Refer to the dimensional drawings on page: 4.

prefix option	safety parameters				
	U _i (DC) (V)	I _i (mA)	P _i (W)	L _i (µF)	C _i (mF)
Low Power (LP)					
LISC	30	300	1,6	0	0

⁽³⁾ Min. operating current (I_{(ON) min.}): 0,036 A / U_{(ON) min.} = 12,8 V (For use in zone 0 locations, see the installation conditions given in the I&M instructions)

⁽⁴⁾ Intrinsically safe pilots: Check the electrical characteristics in the corresponding catalogue pages (LISC: 19500036/LISC pilot).

⁽⁵⁾ 314/LPK: Contact us

Electrical connections

prefix	connection
⁽⁵⁾	1/2" NPT threaded cable entry. Enclosures are supplied without cable gland
LISC	Spade plug connector with cable gland EN175301-803A (ISO 4400) for cables with an outer diameter from 6 to 8 mm

Additional options

- Mounting on aluminium supply rail, 1/4 or 1/2
- Other pipe threads are available on request

Installation

- Multi language installation/maintenance instructions are included with each valve
- The valves can be mounted in any position without affecting operation
- IEC 61508 Functional Safety (suffix SL). Check temperature range of valve body and solenoid for suitability. For probability of failure, contact us
- It is necessary to connect pipes or fittings to the exhaust ports to protect the internal parts of the spool valve and its pneumatic operator if used outside or in harsh environments (dusts, liquids etc.)
- Threaded pipe connection identifier is 8 = NPT (ANSI 1.20.3); G = G (ISO 228/1)
- Valves with suffix "SL" are provided with specific exhaust protectors

5/2
SERIES
551 - 553

Dimensions (mm), Weight (kg) 

TYPE 01-02: CNOMO (551 Series)
size 30 (E06.05.80)

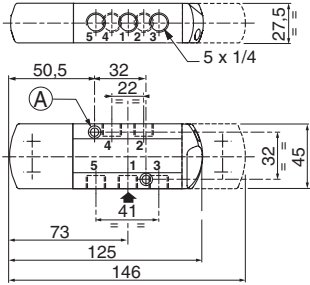

551 Series

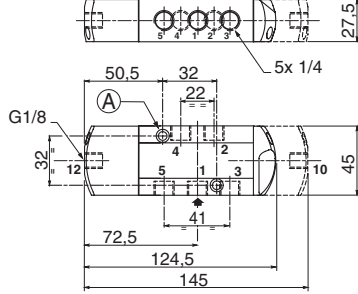

TYPE 03: Air operated

553 Series

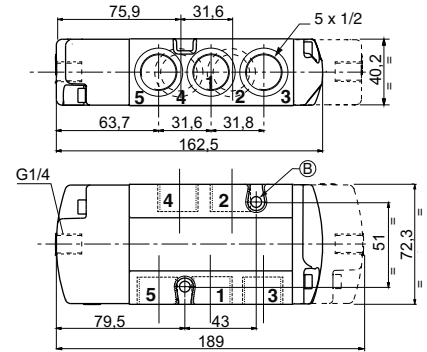

2 mounting holes

- (A) 5,3 mm dia.; Spotfacing: 9 mm dia., depth 5 mm
- (B) 6,5 mm dia.; Spotfacing: 11 mm dia., depth 6 mm



TYPE 01:
314 pilot/LPKF operator
EN/IEC 60079-1, 60079-31



TYPE 02:
Aluminium
195/LISC: EN 60079-11

551: Contact us

551B221 / 551B222

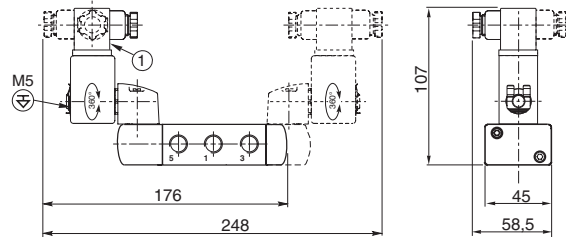
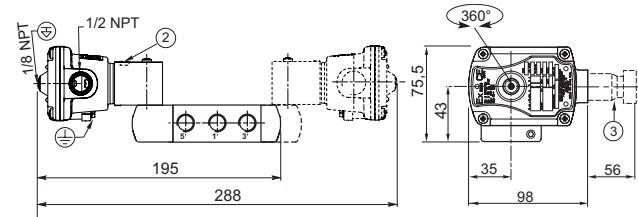

- ① Connector rotatable by 90° increments (cable 6 - 8 mm)
- ② Manual operator location
- ③ Ex d certified cable gland (on request)
- ⊕ Connectable pilot exhaust port

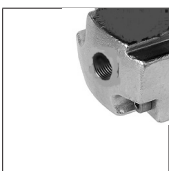

TYPE 03:
No prefix, IP65
[551 suffixes: GD (II 1 GD c) ; SL (SIL) ;
GDSL (SIL, II 1 GD c)
553 suffixes: GD (II 2 GD c) ; SL (SIL) ;
GDSL (SIL, II 2 GD c)]
Air operated version

551A121 / 551A122

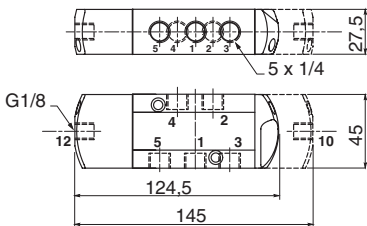

553A121 / 553A122

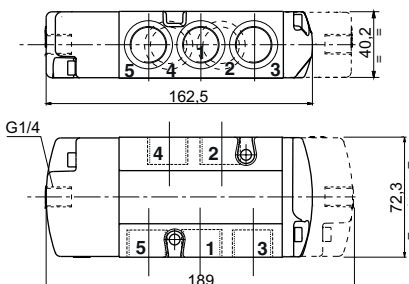

type	prefix/option	power level	weight ⁽¹⁾			
			monostable		bistable	
			551	553	551	553
01	⁽²⁾	BP	1,73	-	2,67	-
02	LISC	LP	1,09	-	1,47	-
03	-	-	0,86	2,52	0,99	3,07

⁽¹⁾ Incl. connector(s), except CFVT.
⁽²⁾ 314/LPKF: Contact us

Accessories

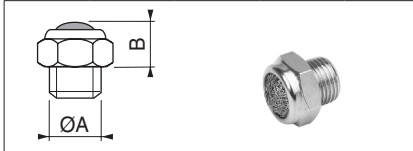

ØA	-	1/8	1/4	1/2
B	-	10	11	14

**exhaust protector
(stainless steel)**