

## REGLAGE

### 1. MODE DE FONCTIONNEMENT DES SORTIES.

#### Mode Hystérésis:

Les réglages sont la valeur de seuil **H** et hystérésis **h**.  
 Ex. **H** = 6 bar - **h** = 0.5 bar  
 N.O. (Normalement Ouvert)

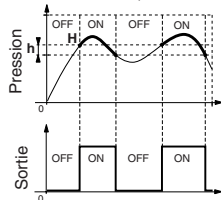

A zéro bar, le signal est sur OFF. Quand le niveau de pression augmente au delà de la valeur de seuil, le signal passe sur ON. Tant que la pression est supérieure à 5.5 bar (= 6 bar - 0.5 bar), le signal reste sur ON. Quand la pression décroît et passe en dessous de 5.5 bar, le signal passe sur OFF.

Pour la configuration en N.F. (Normalement Fermé) c'est l'inverse de N.O. ON devient OFF et vice-versa.

Réglage usine: Sorties 1 & 2 en mode hystérésis.

	psi	kgf/cm <sup>2</sup>	MPa	bar
H - 1	71	5.00	0.49	4.9
h - 1	14	1.00	0.10	1.0
H - 2	99	7.00	0.68	6.8
h - 2	14	1.00	0.10	1.0

#### Mode Comparateur à Fenêtre:

Les réglages sont la limite basse **A** et la limite haute **b**.  
 Ex. **A** = 4 bar - **b** = 6 bar  
 N.O. (Normalement Ouvert)

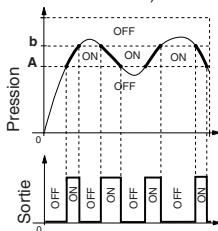

A zéro bar, le signal est sur OFF. Quand le niveau de pression augmente au delà de la limite basse, le signal passe sur ON. Tant que le niveau de pression est dans la fenêtre, entre les limites basses et hautes le signal reste sur ON. Quand la pression devient supérieure à la limite haute, le signal passe sur OFF.

Pour la configuration en N.F. (Normalement Fermé) c'est l'inverse de N.O. ON devient OFF et vice-versa.

Réglage usine:

	psi	kgf/cm <sup>2</sup>	MPa	bar
A - 1	42	3.00	0.29	2.9
b - 1	71	5.00	0.49	4.9
A - 2	85	6.00	0.59	5.9
b - 2	113	8.00	0.78	7.8

### 2. INTERFACE.

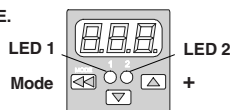

**Affichage :** Valeurs pré-réglées en mode réglage.

Valeur de pression en mode mesure.

**Mode :** Pour sélectionner les différents modes.

**+ & - :** Pour modifier les réglages.

**LED Sortie :** Indicateur de l'état des sorties, Sortie 1 ON = rouge, Sortie 2 ON = vert.

### 3. RACCORDEMENT ELECTRIQUE.

- Sorties : NO ou NF au choix, max. 125 mA
- broche 1 = V + = 10,8 à 30 VCC
- broche 2 = sortie 2
- broche 3 = V -
- broche 4 = sortie 1



Séquence d'affichage lors de la mise sous tension



Type                      Unité de pression sélectionnée                      Affichage pression mesurée



RESPECTER LES PRECAUTIONS DE MANIPULATION DES PRODUITS SENSIBLES AUX DECHARGES ELECTROSTATIQUES

### 4. CONFIGURATION DES SORTIES N.O. / N.F. ET DE L'UNITÉ DE PRESSION.

Réglage usine:

	Unité	Sortie 1	Sortie 2
PNP	bar	HYS, N.O.	HYS, N.O.

Une EEPROM intégrée mémorise les données de réglage. Appuyer en même temps sur la touche "mode" et la touche "+"

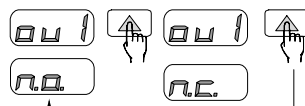

Sélection N.O. ou N.F. pour Sortie 1



Sélection N.O. ou N.F. pour Sortie 2

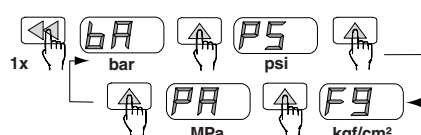

Sélection de l'unité de pression

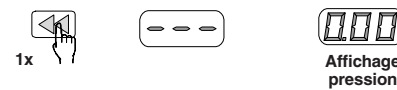

### 5. AJUSTEMENT DU POINT ZÉRO.

Pour une mise à zéro, sans connexion à la pression.



Affichage pression

Maintenez min. 3 sec

Affichage pression

### 6. VERROUILLAGE DES VALEURS DE RÉGLAGE.

Appuyer en même temps sur la touche mode et sur la touche "+", le pressostat est verrouillé; les valeurs réglées ne peuvent être changées. Quand on le fait une deuxième fois, le pressostat est déverrouillé et on peut à nouveau changer les réglages.

### 7. OPÉRATION EN MODE RÉGLAGE.

Réglage initial: Sortie 1 & 2: Normalement Ouvert.

Unité de pression: bar

Souhait Sortie 1: Mode hystérésis;

Contact à 6 bar, hystérésis 0,5 bar

#### ■ Choix du mode sortie 1:

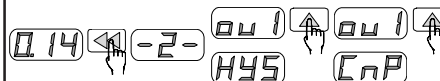

Affichage pression

Sélection mode hystérésis ou comparateur à fenêtre. (Hystérésis comme exemple)

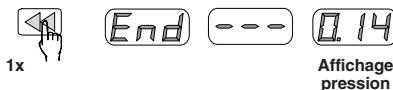

1x

Affichage pression

#### ■ Réglage des valeurs sortie 1:

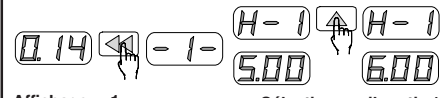

Affichage 1x

Sélection seuil sortie 1 avec touche + ou -



1x

Sélection hystérésis sortie 1 avec touche + ou -



1x

Affichage pression

#### ■ Choix du mode sortie 2:

Souhait Sortie 2: Mode comparateur à fenêtre;  
 Contact entre 4 bar et 6 bar  
 (Limite basse A = 4, limite haute b = 6)

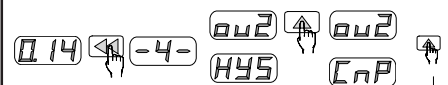

Affichage 4x

Sélection mode hystérésis ou comparateur à fenêtre (Comparateur comme exemple)



1x

Affichage pression

#### ■ Réglage des valeurs sortie 2:

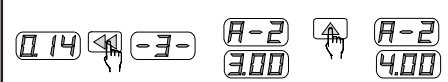

Affichage 3x

Sélection limite basse sortie 2 avec touche + ou - (ex: 4 bar)



1x

Sélection limite haute sortie 2 avec touche + ou - (ex: 6 bar)



1x

Affichage pression

### 8. AFFICHAGE DES VALEURS MAXI ET MINI.

La mémoire interne stocke la valeur la plus haute (Maxi) et la valeur la plus basse (Mini) mesurées à partir du moment où les sorties sont câblées. Elles peuvent s'afficher comme suit:

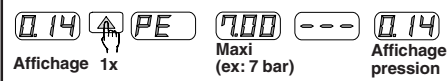

Affichage 1x

Maxi (ex: 7 bar)

Affichage pression



Affichage 1x

Mini (ex: 2 bar)

Affichage pression

### 9. MESSAGES D'ERREUR

Erreur	Message	Solution
ErrP	Pression durant l'ajustement du point zéro, supérieur à ±3% E.M.	Refaire le point zéro dans un autre contexte de pression
CE1	Surintensité sortie 1	Baissez le courant Maintenez le courant à 125mA maxi.
CE2	Surintensité sortie 2	Vérifiez le câblage
FFP	Application d'une pression supérieure au calibre.	Application d'une pression compatible au calibre

## ATTENTION



# Installation and operation

## ELECTRONIC PRESSURE SWITCH WITH DIGITAL DISPLAY

### Hysteresis and comparator functions

#### PROGRAMMING PROCEDURE

##### 1. OUTPUT MODES

###### Hysteresis mode:

Adjustment of switch point **H** and hysteresis range **h**.  
 Ex.: **H** = 6 bar - **h** = 0.5 bar  
 N.O. (Normally Open)

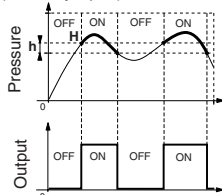

At 0 bar, the output signal is turned "OFF". Whenever pressure crosses above the switch point, the output signal is turned "ON". As long as the pressure is above 5.5 bar (= 6 bar - 0.5 bar), the output signal remains "ON". Whenever pressure decreases and crosses below 5.5 bar, the output signal is turned "OFF". In the N.C. (Normally Closed) as opposed to the N.O. (Normally Open) configuration, ON becomes OFF and vice-versa.  
**Factory setting:** outputs 1 & 2 in the hysteresis mode.

	psi	kgf/cm <sup>2</sup>	MPa	bar
H - 1	71	5.00	0.49	4.9
h - 1	14	1.00	0.10	1.0
H - 2	99	7.00	0.68	6.8
h - 2	14	1.00	0.10	1.0

###### Window comparator mode:

Adjustment of lower limit **A** and upper limit **b**.  
 Ex.: **A** = 4 bar - **b** = 6 bar  
 N.O. (Normally Open)

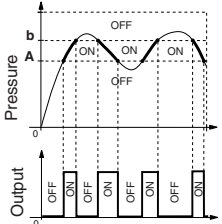

At 0 bar, the output signal is turned "OFF". Whenever pressure crosses above the lower limit, the output signal is turned "ON". As long as the pressure level remains within the upper and lower limits of the window, the output signal remains "ON". Whenever the pressure crosses above the upper limit, the output signal is turned "OFF". In the N.C. (Normally Closed) as opposed to the N.O. (Normally Open) configuration, ON becomes OFF and vice-versa.

**Factory setting:**

	psi	kgf/cm <sup>2</sup>	MPa	bar
A - 1	42	3.00	0.29	2.9
b - 1	71	5.00	0.49	4.9
A - 2	85	6.00	0.59	5.9
b - 2	113	8.00	0.78	7.8

##### 2. FRONT PANEL

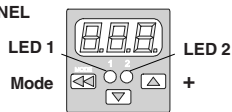

**Display:** Values previously set in setting mode  
 Pressure level in measurement mode

**Mode:** Key to select the different modes

**Up & Down:** Keys to change settings

**Output LED:** Indication of output status

Output 1 ON = red, Output 2 ON = green.

##### 3. ELECTRICAL CONNECTION

- Outputs: N.C. or N.O. at choice, max. 125 mA
- pin 1 = V+ = 10.8 to 30 VDC
- pin 2 = output 2
- pin 3 = V-
- pin 4 = output 1



Display sequence when power is switched on.

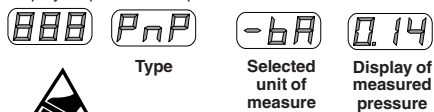

##### 4. CONFIGURATION OF N.O. / N.C. OUTPUTS AND UNIT OF MEASURE

**Factory setting:**

	Unit	Output 1	Output 2
PNP	bar	HYS, N.O.	HYS, N.O.

To store the settings in the integrated EEPROM, press the "mode" and the "arrow up" keys simultaneously.

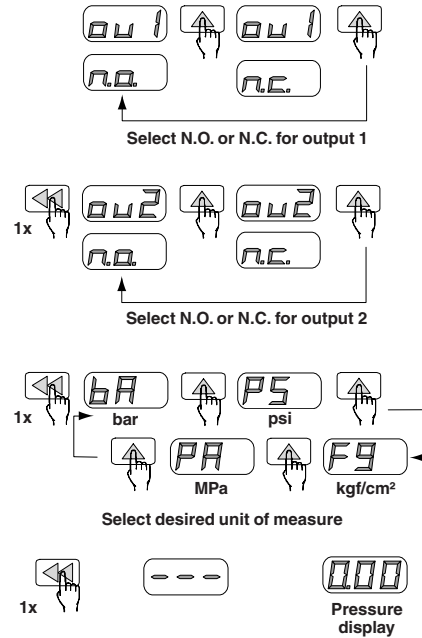

##### 5. ZERO-POINT ADJUSTMENT

To reset to zero without connecting to pressure supply.

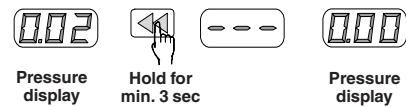

##### 6. LOCKOUT

Press the "mode" and "arrow down" keys simultaneously to lock the pressure switch to prevent unwanted changes to the adjustments. Repeat the above procedure to unlock the pressure switch and change the settings.

##### 7. SETTING MODE

Initial settings: Output 1 & 2 = Normally Open  
 Unit of measure: bar  
 Desired setting for output 1: Hysteresis mode; switching at 6 bar; hysteresis 0.5 bar.

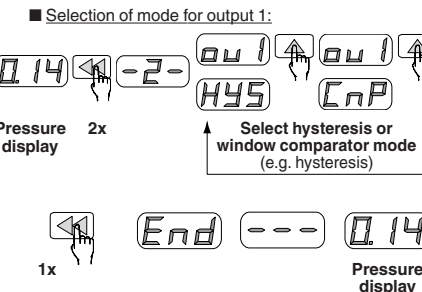

##### Setting of values for output 1:

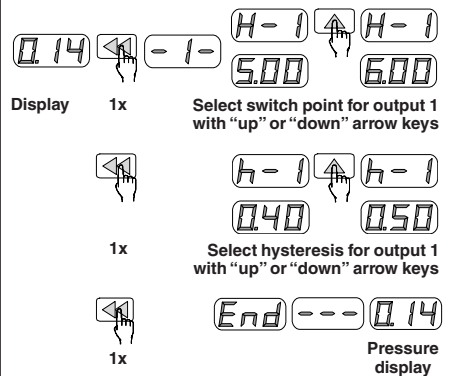

##### Selection of mode for output 2:

Desired setting for output 2: Window comparator mode; switching in 4 to 6 bar range (lower limit A = 4, upper limit b = 6)

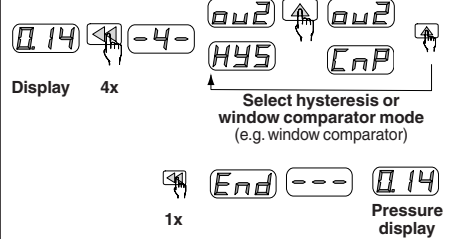

##### Setting of values for output 2:

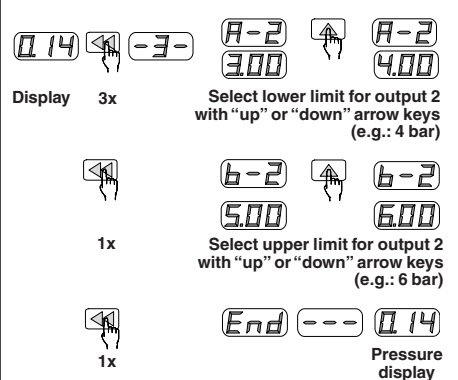

##### 8. DISPLAY OF PEAK VALUE AND BOTTOM VALUE

The highest (max.) and lowest (min.) pressure values measured from the time the outputs are connected to power supply are stored in the integrated memory. The values are displayed as follows:

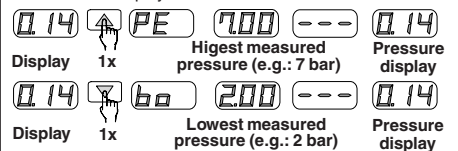

##### 9. ERROR MESSAGES

Error	Message	Troubleshooting
Err	Pressure during zero-point adjustment exceeds $\pm 3\%$ F.S.	Readjust the zero point in a different pressure environment
CE1	Overcurrent at output 1	Keep the current below 125 mA at maximum.
CE2	Overcurrent at output 2	Check cabling.
FFF	Applied pressure is above calibrated pressure range.	Apply pressure within the calibrated pressure range.
-FF		

### CAUTION

OBSERVE PRECAUTIONS FOR HANDLING ELECTROSTATIC SENSITIVE DEVICES



**PROGRAMMIERUNG**

**1. EINSTELLMÖGLICHKEIT DER AUSGÄNGE**

**Hysterese-Modus:**

Einstellung des Schaltpunkts H und der Hysterese h.  
 z.B.: H = 6 bar - h = 0.5 bar  
 NO (normal offen)

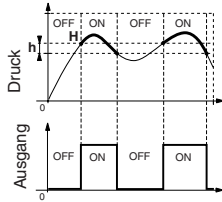

Bei 0 bar ist das Ausgangssignal AUS. Sobald der Druck den Schaltpunkt übersteigt, schaltet das Ausgangssignal EIN. Solange der Druck über 5,5 bar beträgt (= 6 bar - 0,5 bar), bleibt das Ausgangssignal EIN. Wenn der Druck unter 5,5 bar fällt, schaltet das Ausgangssignal AUS. Im Gegensatz zur NO-Konfiguration wird in der NC-Konfiguration (normal geschlossen), EIN zu AUS und umgekehrt.  
 Werkseinstellung: Ausgänge 1 & 2 im Hysterese-Modus.

	psi	kgf/cm <sup>2</sup>	MPa	bar
H - 1	71	5.00	0.49	4.9
h - 1	14	1.00	0.10	1.0
H - 2	99	7.00	0.68	6.8
h - 2	14	1.00	0.10	1.0

**Fenster-Komparator-Modus:**

Einstellung des unteren Schaltpunkts A und des oberen Schaltpunkts b.  
 z.B.: A = 4 bar - b = 6 bar  
 NO (Normal offen)

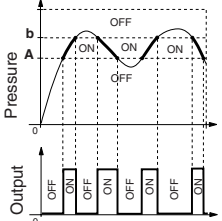

Bei 0 bar ist das Ausgangssignal AUS. Sobald der Druck den unteren Schwellenwert überschreitet, schaltet das Ausgangssignal EIN. Solange sich der Druck innerhalb des oberen und unteren Schwellenwertbereichs befindet, bleibt das Ausgangssignal EIN. Sobald der Druck den oberen Schwellenwert übersteigt, schaltet das Ausgangssignal AUS. Im Gegensatz zur NO-Konfiguration wird in der NC-Konfiguration (normal geschlossen), EIN zu AUS und umgekehrt.  
 Werkseinstellung:

	psi	kgf/cm <sup>2</sup>	MPa	bar
A - 1	42	3.00	0.29	2.9
b - 1	71	5.00	0.49	4.9
A - 2	85	6.00	0.59	5.9
b - 2	113	8.00	0.78	7.8

**2. FRONTTAFEL**

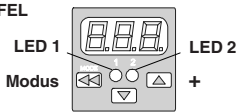

**Anzeige:** Im Einstell-Modus voreingestellte Werte Druckwert im Mess-Modus

**Betriebsart:** Taste zur Wahl der verschiedenen Modi  
**OBEN / UNTEN:** Pfeiltasten zur Änderung der Einstellungen  
**Ausgangs-LED:** Anzeige des Zustands der Ausgänge  
 Ausgang 1 EIN = rot, Ausgang 2 EIN = grün.

**3. ELEKTRISCHER ANSCHLUSS**

- Ausgänge: wahlweise NO oder NC, max. 225 mA
- Pin 1 = V+ = 10.8 bis 30 VDC
- Pin 2 = Ausgang 2
- Pin 3 = V-
- Pin 4 = Ausgang 1



Reihenfolge der Anzeige nach dem Einschalten der Versorgungsspannung.

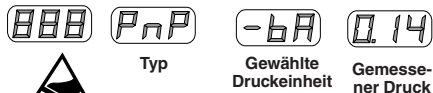

VORSICHT BEI HANDHABUNG VON ELEKTROSTATISCH GEFÄHRDTEN BAUTEILEN (EGB)

**4. KONFIGURATION DER AUSGÄNGE NO / NC- UND DRUCKEINHEIT**

Werkseinstellung:

	Einheit	Ausgang 1	Ausgang 2
PNP	bar	HYS, N.O.	HYS, N.O.

Durch gleichzeitiges Drücken der Taste MODUS und der Pfeiltaste OBEN werden die Einstellungen im integrierten EEPROM gespeichert.



Wählen Sie NO oder NC für Ausgang 1



Wählen Sie NO oder NC für Ausgang 2

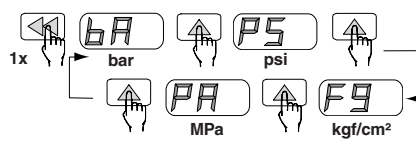

Wählen Sie die gewünschte Druckeinheit

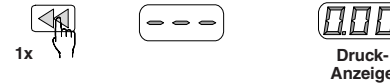

**5. NULLPUNKT-EINSTELLUNG**

Rücksetzen in die Nullstellung ohne Druckbeaufschlagung.



**6. VERRIEGELUNG DER EINSTELLWERTE**

Um ein ungewolltes Verstellen der Einstellungen zu vermeiden, verriegeln Sie den Druckschalter durch gleichzeitiges Drücken der Taste MODUS und der Pfeiltaste UNTEN. Durch erneutes Drücken der beiden Tasten wird der Druckschalter für eine Änderung der Einstellungen entriegelt.

**7. EINSTELL-MODUS**

Anfangseinstellung: Ausgang 1 & 2 = Normal offen

Druckeinheit: bar

Gewünschte Einstellung für Ausgang 1:

Hysterese-Modus;

Schaltung bei 6 bar; Hysterese 0,5 bar.

Wahl des Modus für Ausgang 1:

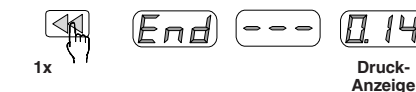
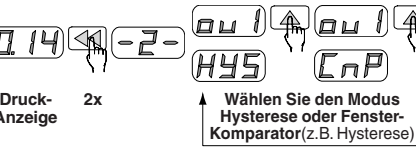

**Wahl der Werte für Ausgang 1:**

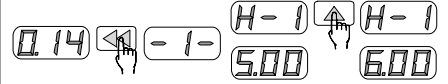

Anzeige 1x Schaltpunkt für Ausgang 1 mit den Pfeiltasten OBEN / UNTEN wählen.

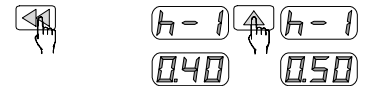

1x Hysterese für den Ausgang 1 mit den Pfeiltasten OBEN / UNTEN wählen.



**Wahl des Modus für Ausgang 2:**

Gewünschte Einstellung für Ausgang 2:

Fenster-Komparator-Modus;

Schaltung im 4 bis 6 bar-Bereich

(unterer Schwellenwert A = 4, oberer Schwellenwert b = 6)

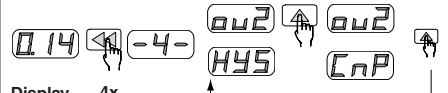

Display 4x Wählen Sie den Modus Hysterese oder Fenster-Komparator (z.B. Fenster-Komparator)

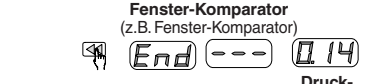

**Einstellung der Werte für Ausgang 2:**

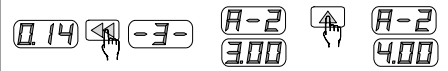

Anzeige 3x Unteren Schwellenwert für Ausgang 2 mit den Pfeiltasten OBEN / UNTEN wählen. (z.B.: 4 bar)



1x Oberen Schwellenwert für Ausgang 2 mit den Pfeiltasten OBEN / UNTEN wählen. (z.B.: 6 bar)

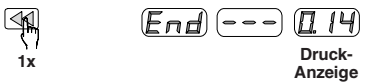

**8. ANZEIGE DES HÖCHSTEN UND DES NIEDRIGSTEN WERTES**

Der höchste (max.) und der niedrigste (min.) gemessene Druckwert ab dem Zeitpunkt des Anschlusses der Versorgungsspannung werden im integrierten Speicher gespeichert. Die Werte werden wie folgt angezeigt:



**9. FEHLERANZEIGE**

Fehler	Meldung	Behebung
Err	Druck bei der Einstellung des Nullpunkts ±3% F.S.	Nullpunkt erneut mit anderen Druckwerten einstellen.
CE1	Überstrom bei Ausgang 1	Den Strom unterhalb max. 125 mA halten.
CE2	Überstrom bei Ausgang 2	Verkabelung überprüfen.
FFF	Der angelegte Druck überschreitet den Druckbereich.	Druck innerhalb des Druckbereichs anlegen.
-FF		

**ACHTUNG**

**PROCEDURA DI PROGRAMMAZIONE**

**1. MODI DI FUNZIONAMENTO DELLE USCITE.**

**Modalità Isteresi:**

Le tarature del valore di soglia **H** e dell'isteresi **h**.  
 Es. **H** = 6 bar - **h** = 0,5 bar  
 N.A. (Normalmente Aperta)

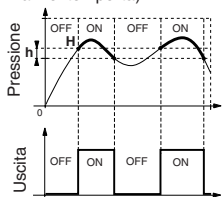

A zero bar, il segnale d'uscita è OFF. Quando la pressione aumenta oltre il valore di soglia, il segnale diventa ON. Finché la pressione è superiore a 5,5 bar (= 6 bar - 0,5 bar), il segnale resta ON. Quando la pressione scende al di sotto di 5,5 bar, il segnale d'uscita diventa nuovamente OFF.

Per la configurazione in N.C. (Normalmente Chiusa) avviene l'inverso. ON diventa OFF e viceversa.

Regolazione di fabbrica: Uscite 1 e 2 in modalità isteresi.

	psi	kgf/cm <sup>2</sup>	MPa	bar
H - 1	71	5.00	0.49	4.9
h - 1	14	1.00	0.10	1.0
H - 2	99	7.00	0.68	6.8
h - 2	14	1.00	0.10	1.0

**Modalità Comparatore a Finestra:**

Le tarature del limite inferiore **A** e il limite superiore **b**.  
 Es. **A** = 4 bar - **b** = 6 bar  
 N.A. (Normalmente Aperta)

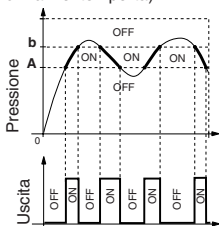

A zero bar, il segnale d'uscita è OFF. Quando il livello di pressione supera il limite inferiore, il segnale diventa ON. Finché il livello di pressione è nella finestra, tra i limiti inferiori e superiori il segnale resta ON. Quando la pressione supera il limite alto, il segnale passa su OFF.

Per la configurazione in N.C. (Normalmente Chiusa) accade l'inverso. ON diventa OFF e viceversa.

Regolazione di fabbrica:

	psi	kgf/cm <sup>2</sup>	MPa	bar
A - 1	42	3.00	0.29	2.9
b - 1	71	5.00	0.49	4.9
A - 2	85	6.00	0.59	5.9
b - 2	113	8.00	0.78	7.8

**2. INTERFACCIA.**

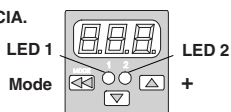

**Display:** Valori preregolati nella modalità setting. Valore di pressione nella modalità misura.

**Mode:** Per selezionare le diverse modalità.  
 + & -: Per modificare le tarature.

**LED Uscita:** Indicatore di stato delle uscite.  
 Uscita 1 ON = rosso, Uscita 2 ON = verde.

**3. COLLEGAMENTO ELETTRICO.**

- Uscite: NA o NC a scelta, max. 125 mA
- pin 1 = V+ = da 10,8 a 30 VCC
- pin 2 = uscita 2
- pin 3 = V-
- pin 4 = uscita 1



Sequenza di visualizzazione alla messa in tensione

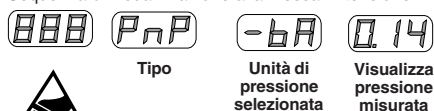

**4. CONFIGURAZIONE DELLE USCITE N.A./N.C. E DELL'UNITÀ DI PRESSIONE.**

Regolazione di fabbrica:

	Unità	Uscita 1	Uscita 2
PNP	bar	IS, N.A.	IS, N.A.

Un'EEPROM integrata memorizza i dati di regolazione. Premi contemporaneamente il tasto "mode" e il tasto "+"

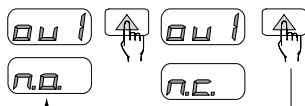

Seleziona N.A. o N.C. per Uscita 1



Seleziona N.A. o N.C. per Uscita 2

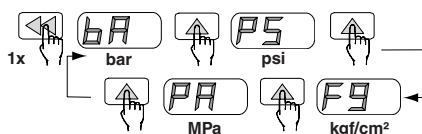

Seleziona l'unità di pressione

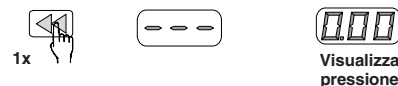

Visualizza pressione

**5. REGOLAZIONE DELLO ZERO.**

Per azzerare senza collegamento alla pressione di alimentazione.



Visualizza pressione Premi min. 3 sec Visualizza pressione

**6. BLOCCO DEI VALORI DI REGOLAZIONE.**

Premi contemporaneamente il tasto mode e il tasto "-", per bloccare il pressostato; non è possibile cambiare i valori regolati. Ripetendo l'operazione, il pressostato si sblocca ed è possibile cambiare di nuovo le tarature.

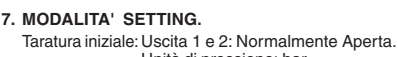

Visualizza 2x pressione

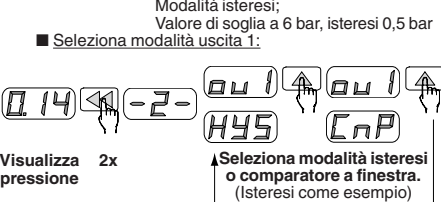

Seleziona modalità isteresi o comparatore a finestra. (Isteresi come esempio)

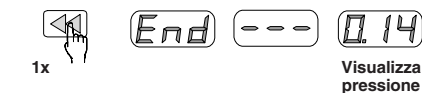

Visualizza pressione

**Taratura valori uscita 1:**

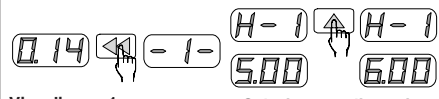

Visualizza 1x

Seleziona soglia uscita 1 con tasto + o -

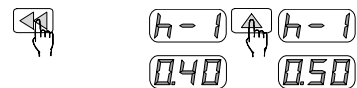

1x

Seleziona isteresi uscita 1 con tasto + o -



1x

Visualizza pressione

**Seleziona modalità di uscita 2:**

Taratura desiderata per Uscita 2:  
 Modalità comparatore a finestra;  
 Valori di soglia tra 4 bar e 6 bar  
 (Limite inferiore A = 4, limite superiore b = 6)

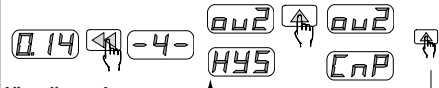

Visualizza 4x

Seleziona modalità isteresi o comparatore a finestra (Comparatore come esempio)

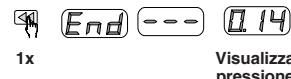

1x

Visualizza pressione

**Taratura valori uscita 2:**

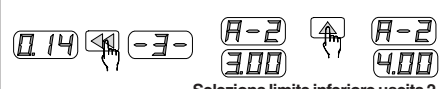

Visualizza 3x

Seleziona limite inferiore uscita 2 con tasto + o - (es.: 4 bar)

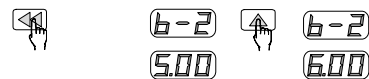

1x

Seleziona limite superiore uscita 2 con tasto + o - (es.: 6 bar)



1x

Visualizza pressione

**8. VISUALIZZAZIONE DEI VALORI MAX. E MIN.**

Vengono internamente memorizzati il valore più alto (max.) e il valore più basso (min.) misurati a partire dal momento in cui le uscite sono alimentate. Possono essere visualizzati come segue:

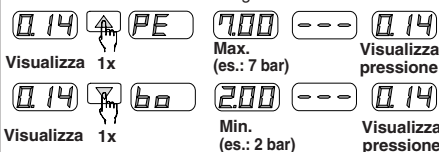

Visualizza 1x

Max. (es.: 7 bar)

Visualizza pressione



Visualizza 1x

Min. (es.: 2 bar)

Visualizza pressione

**9. MESSAGGI DI ERRORE**

Errore	Messaggio	Soluzione
ErrP	Pressione durante la regolazione dello zero superiore a ± 3% F.S.	Tarare nuovamente lo zero
CE1	Sovratensione uscita 1	Mantenere la corrente a 125mA max. Controllare il cablaggio
CE2	Sovratensione uscita 2	Mantenere la corrente a 125mA max. Controllare il cablaggio
FFP	Applicazione di una pressione superiore alla gamma di regolazione.	Applicare una pressione compatibile con la gamma di regolazione
-FF		

**ATTENZIONE**

OSSERVARE LE PRECAUZIONI PER LA MANIPOLAZIONE DEI PRODOTTI SENSIBILI ALLE SCARICHE ELETTROSTATICHE



**REGULACIÓN**

**1. MODO DE FUNCIONAMIENTO DE LAS SALIDAS.**

**Modo Histéresis:**

Las regulaciones son el valor de umbral H e histéresis h.  
 Ej. H = 6 bar - h = 0.5 bar  
 N.A. (Normalmente Abierto)

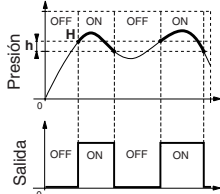

A cero bar, la señal está en OFF. Cuando el nivel de presión aumenta por encima del valor del umbral, la señal pasa a ON. Mientras que la presión es superior a 5.5 bar (= 6 bar - 0.5 bar), la señal permanece en ON. Cuando la presión decrece y pasa por debajo de 5.5 bar, la señal pasa a OFF.  
 Para la configuración en N.C. (Normalmente Cerrada) es a la inversa de N.A. ON pasa a OFF y viceversa.  
 Regulación en fábrica: Salidas 1 & 2 en modo histéresis.

	psi	kgf/cm <sup>2</sup>	MPa	bar
H - 1	71	5.00	0.49	4.9
h - 1	14	1.00	0.10	1.0
H - 2	99	7.00	0.68	6.8
h - 2	14	1.00	0.10	1.0

**Modo Comparador en Ventana:**

Las regulaciones son el límite bajo A y el límite alto b.  
 Ej. A = 4 bar - b = 6 bar  
 N.A. (Normalmente Abierto)

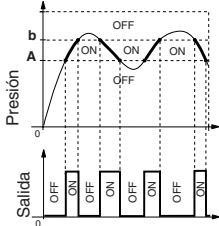

A cero bar, la señal está en OFF. Cuando el nivel de presión aumenta por encima del límite bajo, la señal pasa a ON. Mientras que el nivel de presión está en la ventana, entre los límites bajos y altos la señal permanece en ON. Cuando la presión es superior al límite alto, la señal pasa a OFF.  
 Para la configuración en N.C. (Normalmente Cerrado) es la inversa de N.A. ON pasa a OFF y viceversa.  
 Regulación en fábrica:

	psi	kgf/cm <sup>2</sup>	MPa	bar
A - 1	42	3.00	0.29	2.9
b - 1	71	5.00	0.49	4.9
A - 2	85	6.00	0.59	5.9
b - 2	113	8.00	0.78	7.8

**2. INTERFACE.**

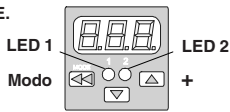

**Visualización:** Valores prerregulados en modo regulación.  
 Valor de presión en modo medida.  
**Modo:** Para seleccionar los diferentes modos.  
 + & -: Para modificar las regulaciones.  
**LED Salida:** Indicador del estado de las salidas,  
 Salida 1 ON = rojo, Salida 2 ON = verde.

**3. CONEXIÓN ELÉCTRICA.**

- Salidas : NA o NC a elegir, máx. 125 mA
- clavija 1 = V + = 10,8 a 30 VCC
- clavija 2 = salida 2
- clavija 3 = V -
- clavija 4 = salida 1



Secuencia de visualizaciones durante la puesta con tensión

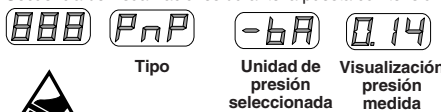

**4. CONFIGURACIÓN DE LAS SALIDAS N.A. / N.C. Y DE LA UNIDAD DE PRESIÓN.**

Regulación en fábrica:

	Unidad	Salida 1	Salida 2
PNP	bar	HYS, N.O.	HYS, N.O.

Una EEPROM integrada memoriza los datos de regulación.  
 Presionar al mismo tiempo sobre el botón "modo" y el "+"

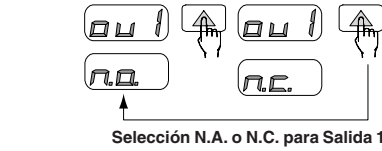

Selección N.A. o N.C. para Salida 1

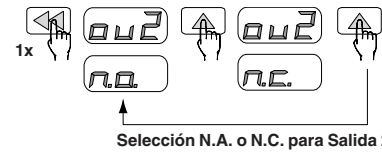

Selección N.A. o N.C. para Salida 2



Selección de la unidad de presión

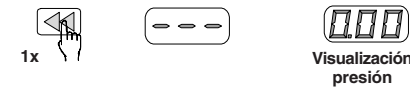

**5. AJUSTE DEL PUNTO CERO.**  
 Para una puesta a cero, sin conexión a la presión.



Visualización presión Mantener mínimo 3 seg Visualización presión

**6. BLOQUEO DE LOS VALORES DE REGULACIÓN.**

Presionar al mismo tiempo sobre el botón modo y sobre el "-", el prestatato está bloqueado; los valores regulados no pueden ser cambiados. Cuando lo hacemos por segunda vez, el prestatato se desbloquea y podemos de nuevo cambiar las regulaciones.

**7. OPERACIÓN EN MODO REGULACIÓN.**

Regulación inicial: Salida 1 & 2: Normalmente Abierto.  
 Unidad de presión: bar  
 Desea Salida 1: Modo histéresis;  
 Contacto a 6 bar, histéresis 0,5 bar

**Elección del modo salida 1:**

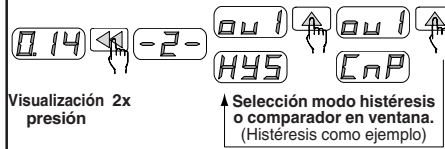

Visualización 2x presión Selección modo histéresis o comparador en ventana. (Histéresis como ejemplo) Visualización presión

**Regulación de los valores salida 1:**

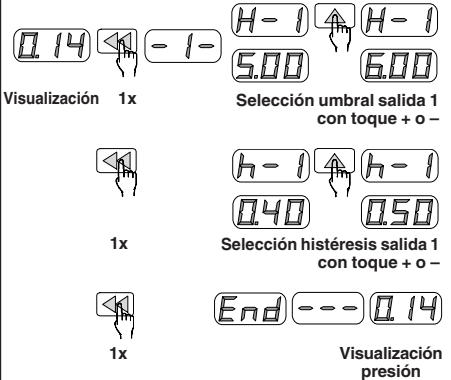

**Elección del modo salida 2:**

Desea Salida 2: Modo comparador en ventana;  
 Contacto entre 4 bar y 6 bar  
 (Límite bajo A = 4, límite alto b = 6)

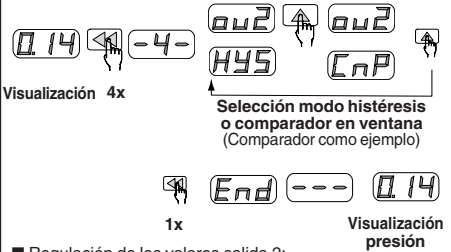

**Regulación de los valores salida 2:**

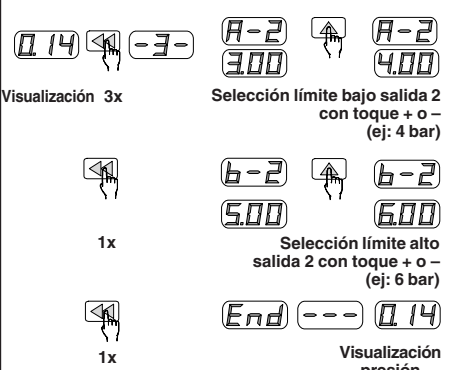

**8. VISUALIZACIÓN DE LOS VALORES MÁX. Y MÍN.**

La memoria interna almacena el valor mas alto (Máx.) y el valor mas bajo (Mín.) medidos a partir del momento en el que las salidas son cableadas. Se pueden visualizar como sigue:



**9. MENSAJES DE ERROR**

Error	Mensaje	Solución
Epp	Presión durante el ajuste del punto cero, superior a ±3% E.M.	Rehacer el punto cero en otro contexto de presión
CE1	Sobreintensidad salida 1	Bajar la corriente Mantener la corriente a 125mA máx.
CE2	Sobreintensidad salida 2	Verificar el cableado
FFP	Aplicación de una presión superior al calibre.	Aplicación de una presión compatible al calibre

**ATENCIÓN**



RESPECTAR LAS PRECAUCIONES DE MANIPULACIÓN DE LOS PRODUCTOS SENSIBLES A DESCARGAS ELECTROSTÁTICAS

**INSTELLEN**

**1. WERKING VAN DE UITGANGEN.**

**Modus Hysteresis:**

De instellingen zijn de drempelwaarde H en hysteresis h.  
 Bijv. H = 6 bar - h = 0.5 bar  
 N.O. (Normaal geopend)

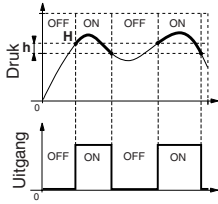

Bij nul bar staat het signaal op OFF. Wanneer het drukniveau de drempelwaarde overschrijdt, gaat het signaal over op ON. Zolang de druk groter is dan 5.5 bar (= 6 bar - 0.5 bar), blijft het signaal op ON. Wanneer de druk afneemt en onder 5.5 bar komt, gaat het signaal over op OFF. Voor de configuratie als N.C. (Normaal gesloten) geldt het omgekeerde van N.O. ON wordt OFF en omgekeerd.  
 Instelling machine: Uitgangen 1 & 2 in de modus hysteresis.

	psi	kgf/cm <sup>2</sup>	MPa	bar
H - 1	71	5.00	0.49	4.9
h - 1	14	1.00	0.10	1.0
H - 2	99	7.00	0.68	6.8
h - 2	14	1.00	0.10	1.0

**Modus Meetklok met venster:**

De instellingen zijn de ondergrens A en de bovengrens b.  
 Bijv. A = 4 bar - b = 6 bar  
 N.O. (Normaal geopend)

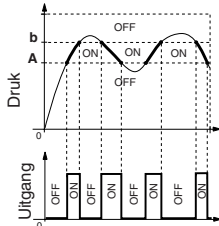

Bij nul bar, staat het signaal op OFF. Wanneer het drukniveau boven de ondergrens komt, gaat het signaal over op ON. Zolang het drukniveau binnen het venster blijft, tussen de ondergrens en bovengrens, blijft het signaal op ON. Wanneer de druk de bovengrens overschrijdt, gaat het signaal over op OFF.

Voor de configuratie als N.C. (Normaal geopend) geldt het omgekeerde van N.O. ON wordt OFF en omgekeerd.

**Instelling machine:**

	psi	kgf/cm <sup>2</sup>	MPa	bar
A - 1	42	3.00	0.29	2.9
b - 1	71	5.00	0.49	4.9
A - 2	85	6.00	0.59	5.9
b - 2	113	8.00	0.78	7.8

**2. INTERFACE.**

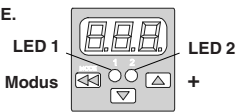

**Weergave:** Vooraf ingestelde waarden in instelmodus. Drukwaarde in meetmodus.

**Modus:** Om de verschillende modi te selecteren. + & - : Om de instellingen te wijzigen.

**LED Uitgang:** Geeft de status van de uitgangen aan, Uitgang 1 ON = rood, Uitgang 2 ON = groen.

**3. ELEKTRISCHE AANSLUITING.**

- Uitgangen : NO of NF naar keuze, max. 125 mA
- pen 1 = V + = 10,8 bij 30 VCC
- pen 2 = uitgang 2
- pen 3 = V -
- pen 4 = uitgang 1



Weergavevolgorde bij het onder spanning brengen

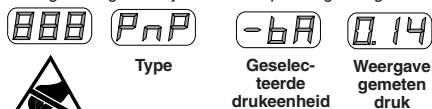

NEEM DE VOORZORGSMAATREGELEN IN ACHT VOOR HET GEBRUIK VAN PRODUCTEN DIE GEVOELIG ZIJN VOOR ELEKTROSTATISCHE ONTLADINGEN

**4. CONFIGURATIE VAN DE UITGANGEN N.O. / N.C. EN VAN DE DRUKEENHEID.**

**Instelling machine:**

	Eenheid	Uitgang 1	Uitgang 2
PNP	bar	HYS, N.O.	HYS, N.O.

De instelgegevens worden opgeslagen op een geïntegreerd EEPROM-geheugen.

Druk tegelijkertijd op de knop "mode" en de toets "+"

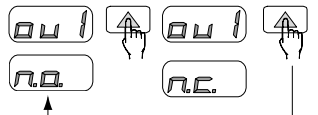

Selectie van N.O. of N.C. voor Uitgang 1

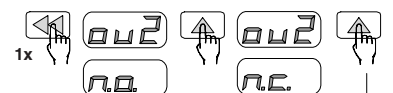

Selectie van N.O. of N.C. voor Uitgang 2

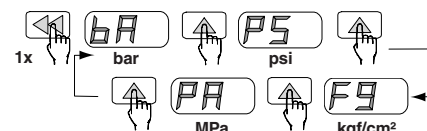

Selectie van de drukeenheid

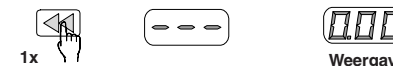

**5. AANPASSING VAN HET NULPUNT.**

Voor een nulstelling zonder aansluiting op de druk.

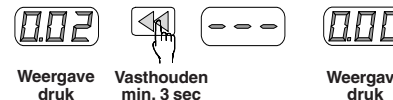

**6. VERGRENDING VAN DE INSTELWAARDEN.**

Druk tegelijkertijd op de knop "mode" en de toets "-"; de pressostaat is vergrendeld; de instelwaarden kunnen niet worden gewijzigd. Wanneer u dit nogmaals doet, wordt de pressostaat ontgrendeld en kunnen de instellingen gewijzigd worden.

**7. WERKING IN DE INSTELMODUS.**

Begininstelling: Uitgang 1 & 2: Normaal geopend  
 Drukeenheid: bar  
 Gewenste Uitgang 1: Modus hysteresis;  
 Contact bij 6 bar;  
 hysteresis 0,5 bar.

**Keuze van de modus uitgang 1:**

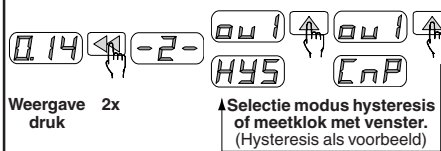

Weergave druk 2x druk

Selectie modus hysteresis of meetklok met venster. (Hysteresis als voorbeeld)

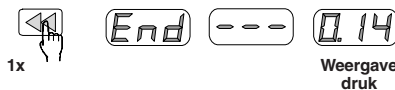

1x

Weergave druk

**Instelling van de waarden uitgang 1:**

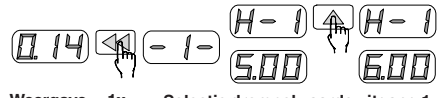

Weergave 1x

Selectie drempelwaarde uitgang 1 met toets + of -

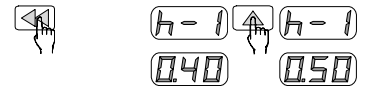

1x

Selectie hysteresis uitgang 1 met toets + of -



1x

Weergave druk

**Keuze van de modus uitgang 2:**

Gewenste Uitgang 2: Modus meetklok met venster;  
 Contact tussen 4 bar en 6 bar  
 (Ondergrens A = 4, bovengrens b = 6)

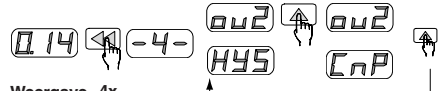

Weergave 4x

Selectie modus hysteresis of meetklok met venster (Meetklok als voorbeeld)

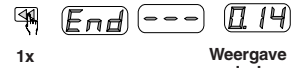

1x

Weergave druk

**Instelling van de waarden uitgang 2:**

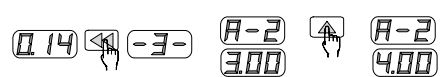

Weergave 3x

Selectie ondergrens uitgang 2 met toets + of - (bijv.: 4 bar)



1x

Selectie bovengrens uitgang 2 met toets + of - (bijv.: 6 bar)

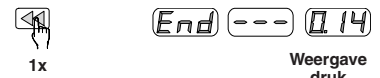

1x

Weergave druk

**8. WEERGAVE VAN DE MAXIMUM- EN MINIMUMWAARDEN**

Het interne geheugen slaat de maximale waarde (Maxi) en de minimale waarde (Mini) op die zijn gemeten vanaf het moment waarop de uitgangen worden bekabeld. Deze kunnen als volgt worden weergegeven:

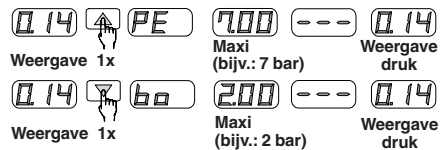

Weergave 1x

Maxi (bijv.: 7 bar)

Weergave druk



Weergave 1x

Maxi (bijv.: 2 bar)

Weergave druk

**9. FOUTBERICHTEN**

Erreur	Message	Solution
ErrP	Druk tijdens de aanpassing van het nulpunt, hoger dan ±3% E.M.	Doe het nulpunt over met een andere omgevingsdruk.
CE1	Overstroom uitgang 1	Verlaag de stroom Houd de stroom op maximaal 125mA. Controleer de bekabeling
CE2	Overstroom uitgang 2	Verlaag de stroom Houd de stroom op maximaal 125mA. Controleer de bekabeling
FFP	Toepassing van een druk die hoger is dan het kaliber.	Toepassing van een druk die compatibel is met het kaliber.
-FF		

**LET OP**