

numatics	INSTALLATION AND MAINTENANCE INSTRUCTIONS	EN
	INSTRUCTIONS D'INSTALLATION ET DE MAINTENANCE	FR
	INBETRIEBNAHME - UND WARTUNGSANLEITUNG	DE
	INSTRUCCIONES DE PUESTA EN MARCHA Y MANTENIMIENTO	ES
	ISTRUZIONI DI MESSA IN SERVIZIO E MANUTENZIONE	IT
	ALGEMENE INSTALLATIE- EN ONDERHOUDSINSTRUCTIES	NL
	INSTALLASJONS- OG VEDLIKEHOLDSINSTRUKSER	NO
	INSTALLATIONS- OCH UNDERHÅLLSINSTRUKTIONER	SE
	ASENNUS - JA HUOLTO-OHJEET	FI
	INSTALLATIONS - OG VEDLIGEHOIDSANVISNINGER	DK
	INSTRUÇÕES DE INSTALAÇÃO E MANUTENÇÃO	PT
	ΟΔΗΓΙΕΣ ΤΟΠΟΘΕΤΗΣΗΣ ΚΑΙ ΣΥΝΤΗΡΗΣΗΣ	GR
	POKRYTY PRO INSTALACI A ÚDRŽBU	CZ
	INSTRUKCJA MONTAŻU I KONSERWACJI	PL
TELEPÍTÉSI ÉS KARBANTARTÁSI ÚTMUTATÓ	HU	
Инструкция по установке и обслуживанию	RU	
ΟΡΗΑΤΥ ЖӘНЕ ҚЫЗМЕТ КӨРСЕТУ НҰСҚАУЛАР	KZ	

502

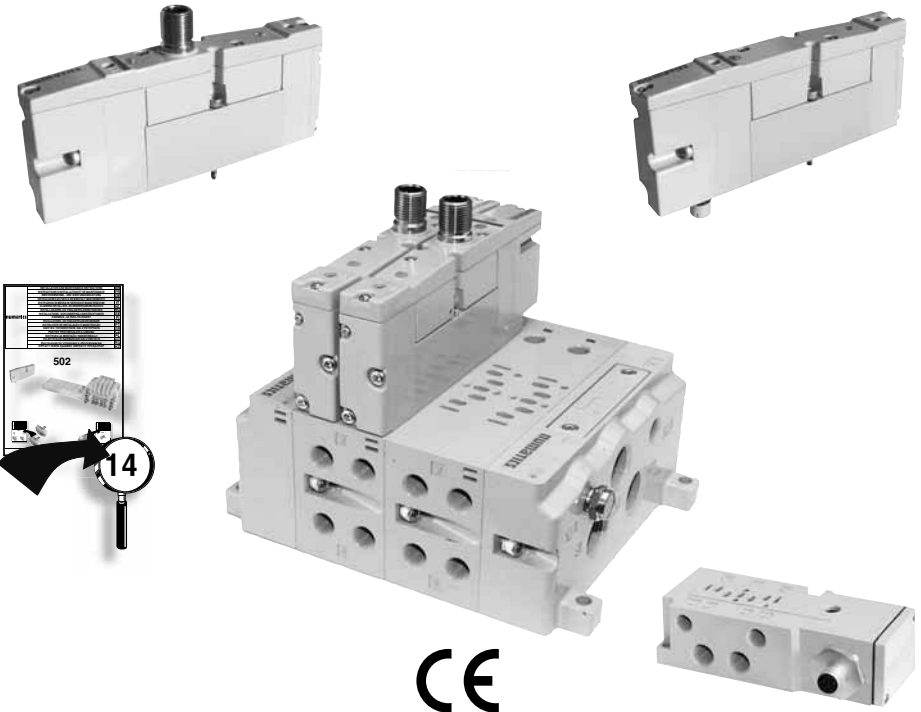

CE

527166-001 / C Availability, design and specifications are subject to change without notice. All rights reserved.

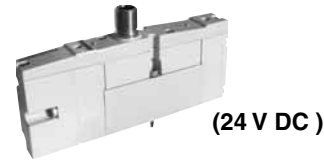
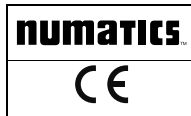

ISO 15407-1 18 mm

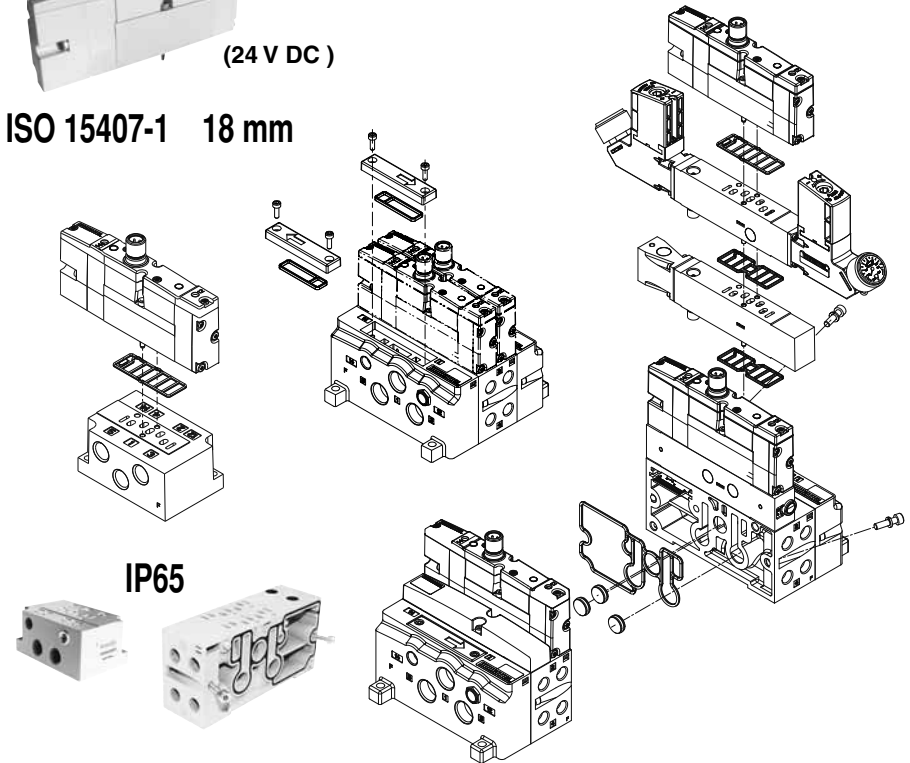

IP65

(24 V DC)











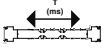



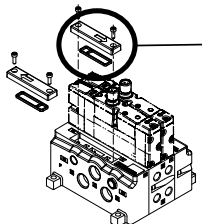
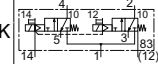
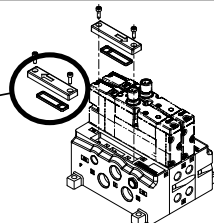
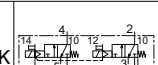

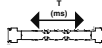



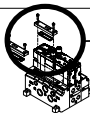

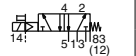
ISO 15407-2 18 mm

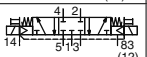

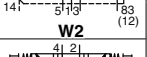
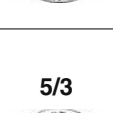
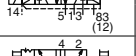
IP65

(24 V DC)

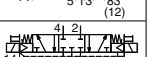

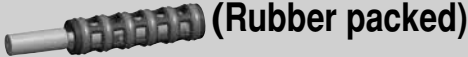
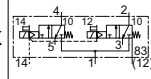

numatics		rated flow		 T (ms)	14 P _p (bar) (23°C)	1 P (bar)				
		 l/min	o / c			min.	max.	min.	max. (PS)	
(14)	(12)	6,3 bar		o / c	min.	max.		min.	max. (PS)	
		l/min (ANR)								
		1→2 1→4	2→3 4→5	(ms)						
 (Rubber packed)										
 → internal pilot supply										
2 x 3/2 NC	K		500	440	36 / 15	-	-	-	4	10
							-	-	4	8
 ← external pilot supply										
2 x 3/2 NC	K		500	440	36 / 15	4	10	-	2	10
							-	8	2	8

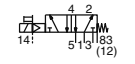
numatics		rated flow		 T (ms)	14 P _p (bar) (23°C)	1 P (bar)				
		 l/min	o / c			min.	max.	min.	max. (PS)	
(14)	(12)	6,3 bar		o / c	min.	max.		min.	max. (PS)	
		l/min (ANR)								
		1→2 1→4	2→3 4→5	(ms)					=	
 (Spool & Sleeve)										
 → internal pilot supply										
5/2			410	390	16 / 49	-	-	-	2	10
							-	-	2	8
							-	-	1,5	10
5/3			410	390	11 / 26	-	-	-	1,5	8
							-	-	1,5	8
							-	-	1,5	8
5/2			410	390	16 / 16	-	-	-	2	10
							-	-	2	8
							-	-	2	8
5/3			360	350	12 / 12	-	-	-	1,5	10
							-	-	1,5	8
							-	-	1,5	8
5/3			370	350	13 / 23	-	-	-	1,5	10
							-	-	1,5	8
							-	-	1,5	8
5/2			410	390	16 / 16	-	-	-	1,5	10
							-	-	1,5	8
							-	-	1,5	8
5/3			360	350	12 / 12	1,5	10	-	-0,95	10
							-	8	-0,95	8
							-	8	-0,95	8
5/2			410	390	16 / 16	2	10	-	-0,95	10
							-	8	-0,95	8
							-	8	-0,95	8
5/3			360	350	12 / 12	1,5	10	-	-0,95	10
							-	8	-0,95	8
							-	8	-0,95	8
5/3			370	350	13 / 23	1,5	10	-	-0,95	10
							-	8	-0,95	8
							-	8	-0,95	8
5/2			410	390	16 / 16	2	10	-	-0,95	10
							-	8	-0,95	8
							-	8	-0,95	8
5/3			340	350	23 / 13	1,5	10	-	-0,95	10
							-	8	-0,95	8
							-	8	-0,95	8

numatics		15-DIGIT PRODUCT CODE 		
		with impulse manual operator ISO 15407-1 18 mm	with maintained manual operator ISO 15407-1 18 mm	without manual operator ISO 15407-1 18 mm
(14)	(12)	 (Rubber packed)		
2 x 3/2 NC		R502A2BD0N83BF1 (R502A2BD0N82PF1) (b)	R502A2BD0N82MF1 (R502A2BD0N69PF1) (b)	R502A2BD0N82NF1 (R502A2BD0N69NF1) (b)
		 (Spool & Sleeve)		
5/2		R502A1B10N83BF1 (R502A1B10N82PF1) (b)	R502A1B10N82MF1 (R502A1B10N69PF1) (b)	R502A1B10N82NF1 (R502A1B10N69NF1) (b)
		R502A1BN0N83BF1 (R502A1BN0N82PF1) (b)	R502A1BN0N82MF1 (R502A1BN0N69PF1) (b)	R502A1BN0N82NF1 (R502A1BN0N69NF1) (b)
		R502A1B40N83BF1 (R502A1B40N82PF1) (b)	R502A1B40N82MF1 (R502A1B40N69PF1) (b)	R502A1B40N82NF1 (R502A1B40N69NF1) (b)
5/3		R502A1B60N83BF1 (R502A1B60N82PF1) (b)	R502A1B60N82MF1 (R502A1B60N69PF1) (b)	R502A1B60N82NF1 (R502A1B60N69NF1) (b)
		R502A1B70N83BF1 (R502A1B70N82PF1) (b)	R502A1B70N82MF1 (R502A1B70N69PF1) (b)	R502A1B70N82NF1 (R502A1B70N69NF1) (b)
		R502A1B50N83BF1 (R502A1B50N82PF1) (b)	R502A1B50N82MF1 (R502A1B50N69PF1) (b)	R502A1B50N82NF1 (R502A1B50N69NF1) (b)





(b) Internal piloting (internal supply).

AIR QUALITY [ISO 8573-1 (2010)]: Level 7.4.4

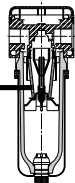

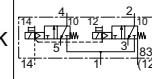

40 μm ↔ 5 μm

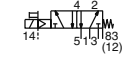
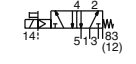

numatics		15-DIGIT PRODUCT CODE 		
		with impulse manual operator ISO 15407-2 18 mm	with maintained manual operator ISO 15407-2 18 mm	without manual operator ISO 15407-2 18 mm
(14)	(12)	 (Rubber packed)		
2 x 3/2 NC		R502A2BD0MA00F1	R502A2BD0M11BF1	R502A2BD0M11MF1
		 (Spool & Sleeve)		
5/2		R502A1B10MA00F1	R502A1B10M11BF1	R502A1B10M11MF1
		R502A1BN0NA00F1	R502A1BN0M11BF1	R502A1BN0M11MF1
		R502A1B40MA00F1	R502A1B40M11BF1	R502A1B40M11MF1
5/3		R502A1B60MA00F1	R502A1B60M11BF1	R502A1B60M11MF1
		R502A1B70MA00F1	R502A1B70M11BF1	R502A1B70M11MF1
		R502A1B50MA00F1	R502A1B50M11BF1	R502A1B50M11MF1

AIR QUALITY [ISO 8573-1 (2010)]: Level 7.4.4

40 μm ↔ 5 μm

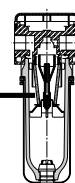

numatics

502



G502AA3A20A0030		1-2-3-4-5 = 5 x G 3/8 12 = G 1/8	
US ▶ 8502AA3A20A0030		1-2-3-4-5 = 5 x NPT 3/8 12 = NPT 1/8	
G502AA3A2014X30		1-2-3-4-5 = 5 x G 3/8 12 = G 1/8 14 = G 1/8	
US ▶ 8502AA3A2014X30		1-2-3-4-5 = 5 x NPT 3/8 12 = NPT 1/8 14 = NPT 1/8	

G502AA3A2M56Y20		1-2-3-4-5 = 5 x G 3/8 12 = G 1/8	
US ▶ 8502AA3A2M56Y20		1-2-3-4-5 = 5 x NPT 3/8 12 = NPT 1/8	
G502AA3A2M59W20		1-2-3-4-5 = 5 x G 3/8 12 = G 1/8 14 = G 1/8	
US ▶ 8502AA3A2M59W20		1-2-3-4-5 = 5 x NPT 3/8 12 = NPT 1/8 14 = NPT 1/8	

numatics

502

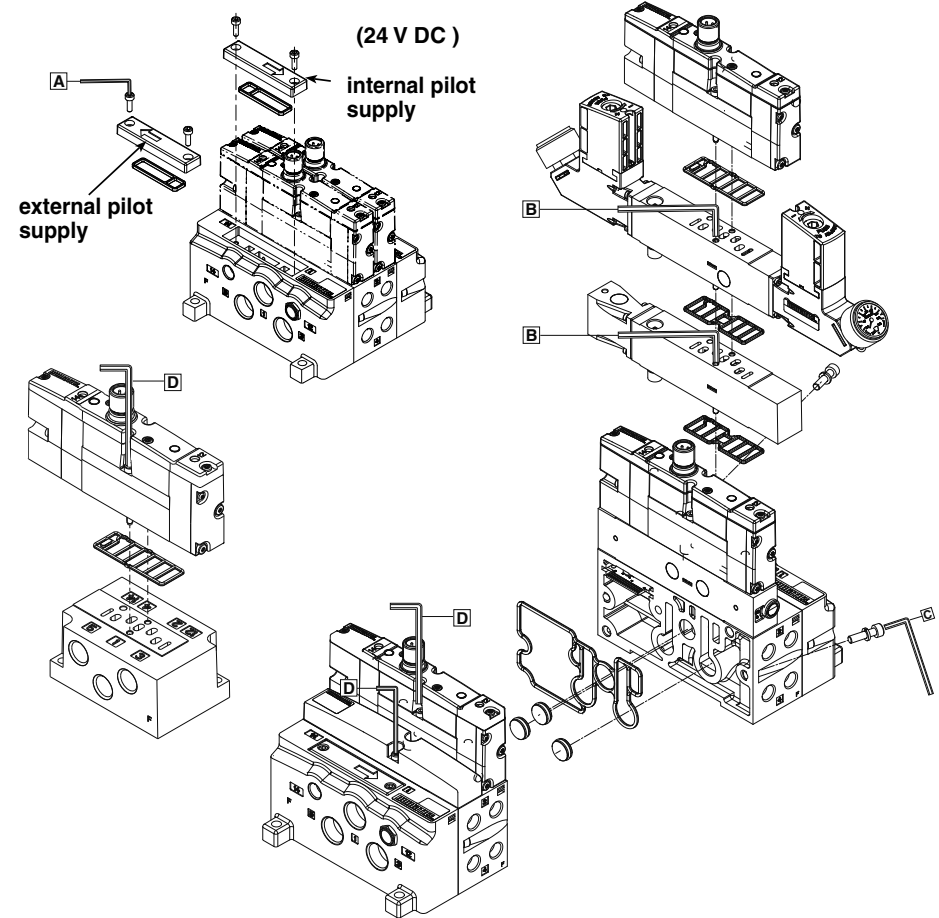
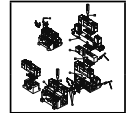

items	N.m	Inch.pounds
A	2 ±10%	17.7 ±1.8
B	1.2 ±10%	10.6 ±1.1
C	4.6 ±10%	40.7 ±4.1
D	2 ±10%	17.7 ±1.8

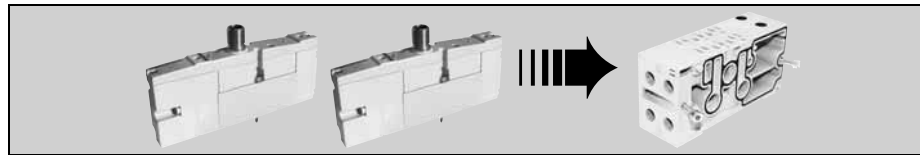

	G502AMV210A0030	4 x G 1/8		
US	8502AMV210A0030	4 x NPT 1/8		

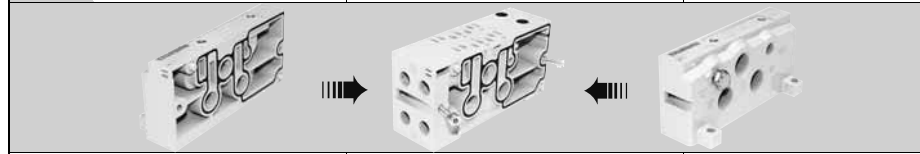

	G502AK431478004	3 x G 3/8 (1/3/5) 2 x G 1/8 (12/14)	
US	8502AK431478001	3 x NPT 3/8 (1/3/5) 2 x NPT 1/8 (12/14)	

P502AB431813001		
------------------------	--	--

P502AD431914001		+		•	1
P502AD431914002		+		•	3
P502AD431914003		+		•	5
P502AD431914004		+		•	1, 3
P502AD431914005		+		•	1, 5
P502AD431914006		+		•	3, 5
P502AD431914007		+		•	1, 3, 5

ISO 15407-1



	R502AY506752001	
--	------------------------	--

G1/4 	G502AW506753002	
-----------------	------------------------	--

G1/4 	G502AX506753001	
-----------------	------------------------	--

	R502AS506755001	
--	------------------------	--

numatics

502

0,7 .. 9 bar



0,7 .. 9 bar
ISO 15407-1



R502ARS120A0030

RS

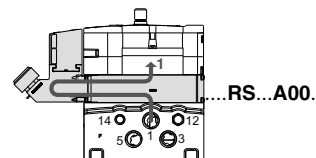

R502ARS12061Y30

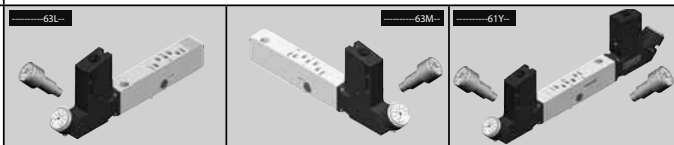

R502ARD12016P30

R502ARD12063L30

R502ARD12016N30

R502ARD12063M30

R502ARD120A0030

R502ARD12061Y30

RD

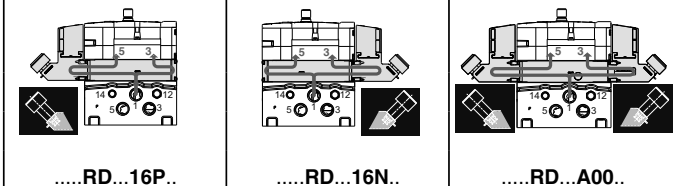

R502ARE12016P00

R502ARE12063L00

R502ARE12016N00

R502ARE12063M00

R502ARE120A0000

R502ARE12061Y00

RE

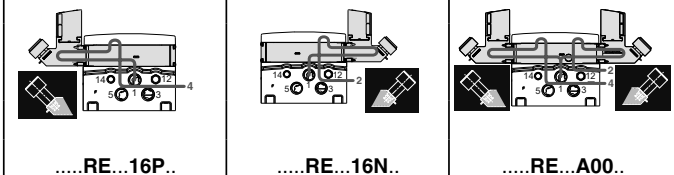

R502ART12016P30

R502ART12063L30

R502ART12016N30

R502ART12063M30

R502ART120A0030

R502ART12061Y30

RT

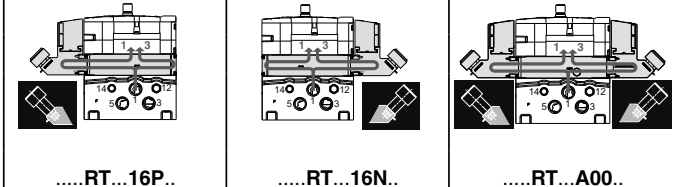

numatics

502

10 .. 130 psig



PSIG ► 10 .. 130 psig
ISO 15407-1

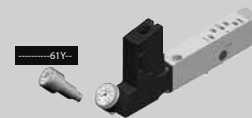

R502ARS110A0030

RS

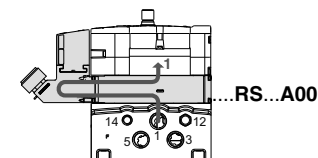

R502ARS11061Y30



R502ARD11016P30

R502ARD11063L30

R502ARD11016N30

R502ARD11063M30

R502ARD110A0030

R502ARD11061Y30

RD

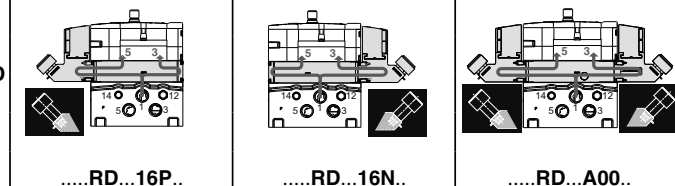

R502ARE11016N30

R502ARE11063L00

R502ARE11016N00

R502ARE11063M00

R502ARE110A0000

R502ARE11061Y00

RE

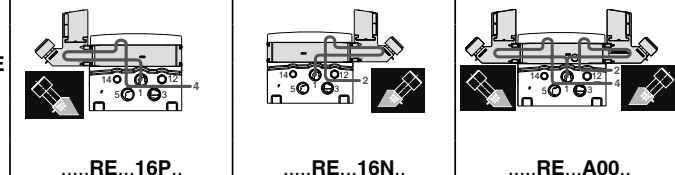

R502ART110A0030

R502ART11063L30

R502ART11016N30

R502ART11063M30

R502ART110A0030

R502ART11061Y30

RT

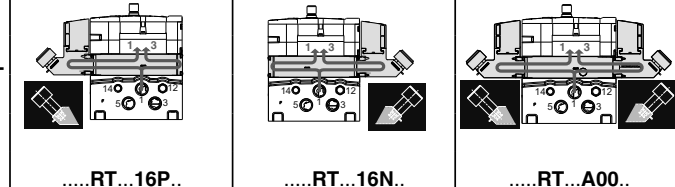

numatics	INSTALLATION AND MAINTENANCE INSTRUCTIONS	EN
	INSTRUCTIONS D'INSTALLATION ET DE MAINTENANCE	FR
	INBETRIEBNAHME - UND WARTUNGSANLEITUNG	DE
	INSTRUCCIONES DE PUESTA EN MARCHA Y MANTENIMIENTO	ES
	ISTRUZIONI DI MESSA IN SERVIZIO E MANUTENZIONE	IT
	ALGEMENE INSTALLATIE- EN ONDERHOUDSINSTRUCTIES	NL
	INSTALLASJONS- OG VEDLIKEHOLDSINSTRUKSER	NO
	INSTALLATIONS- OCH UNDERHÅLLSINSTRUKTIONER	SE
	ASENNUS - JA HUOLTO-OHJEET	FI
	INSTALLATIONS - OG VEDLIGEHOIDSANVISNINGER	DK
	INSTRUÇÕES DE INSTALAÇÃO E MANUTENÇÃO	PT
	ΟΔΗΓΙΕΣ ΤΟΠΟΘΕΤΗΣΗΣ ΚΑΙ ΣΥΝΤΗΡΗΣΗΣ	GR
	POKRYNY PRO INSTALACI A ÚDRŽBU	CZ
INSTRUKCJA MONTAŻU I KONSERWACJI	PL	
TELEPÍTÉSI ÉS KARBANTARTÁSI ÚTMUTATÓ	HU	
Инструкция по установке и обслуживанию	RU	
ОРНАТУ ЖӘНЕ ҚЫЗМЕТ КӨРСЕТУ НҰСҚАУЛАР	KZ	

502

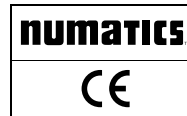
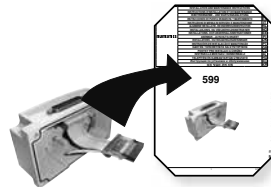
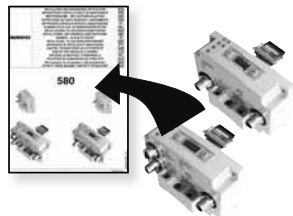
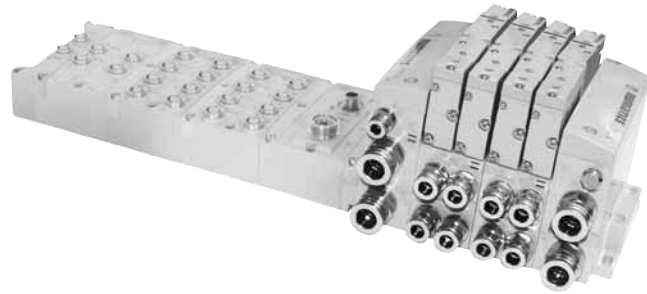
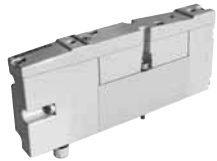

(24 V DC)



High flow

ISO 15407-2 / 18mm

SGL

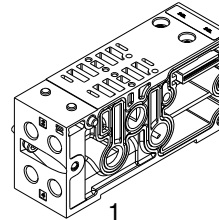

8 G 502AM**S2**GMA0010
K F H

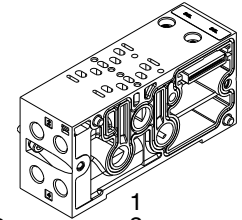
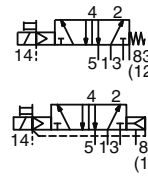

8 G 502AM**S2**GMA0020
K F H

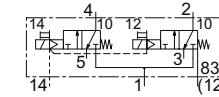

(Rubber packed)

DBL

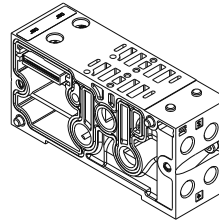

8 G 502AM**M2**GMA0010
K F H

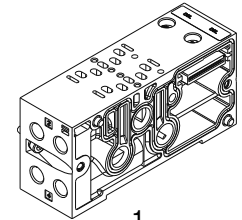
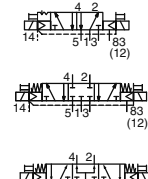

8 G 502AM**M2**GMA0020
K F H

Accessory
Z-board™
Mid station
supply

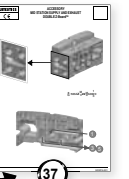

37



X-16 Driver
→ 80 Solenoids
(24 V DC)

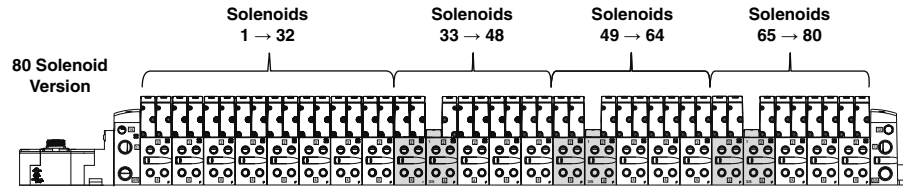

80 Solenoid Version

8 G 502AFM4 K
1 TA0010
2 TA0020
F
H
G

WIRING DIAGRAM

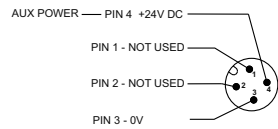

Auxiliary Power and X-16 Driver

Mid-Station Supply

Auxiliary Power and X-16 Driver

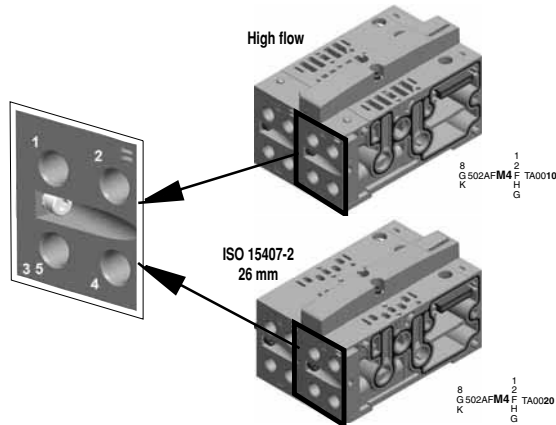
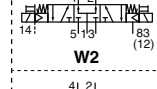
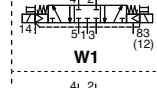
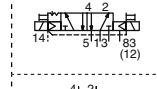
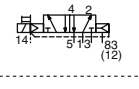
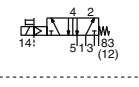
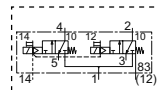

rated flow



6,3 bar
l/min (ANR)

1→2 2→3
1→4 4→5

(ms)

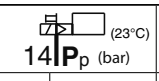

max.



min.



max. (PS)



=

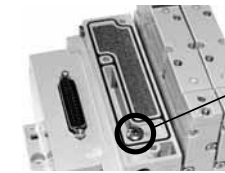

internal pilot supply

2 x 3/2 NC

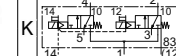

High flow

-

650

600

36 / 15

-

-

4

8

-

ISO

500

440

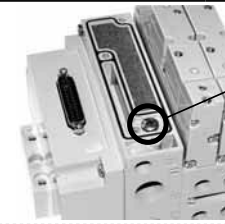

external pilot supply

2 x 3/2 NC

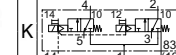

High flow

-

650

600

36 / 15

4

8

2

8

-

ISO

500

440

numatics			rated flow l/min 6,3 bar l/min (ANR)		$\frac{1}{1} P_p$ (23°C) 14 P _p (bar)	$\frac{1}{1} P$ 1 (bar)					
(14) (12)			1→2 1→4	2→3 4→5	min.	max.	min.	max.			
(Spool & Sleeve)											
internal pilot supply											
5/2 		High flow	470	530	16 / 49	-	-	2	8		
		High flow	470	530	11 / 26	-	-	1,5	8		
		High flow	470	530	16 / 16	-	-	2	8		
5/3 		High flow	420	440	12 / 12	-	-	1,5	8		
		High flow	420	430	13 / 23	-	-	1,5	8		
		High flow	380	500	23 / 13	-	-	1,5	8		
external pilot supply											
5/2 		High flow	470	530	16 / 49	2	8	-0,95	8		
		High flow	470	530	11 / 26	1,5	8	-0,95	8		
		High flow	470	530	16 / 16	2	8	-0,95	8		
5/3 		High flow	420	440	12 / 12	1,5	8	-0,95	8		
		High flow	420	430	13 / 23	1,5	8	-0,95	8		
		High flow	380	500	23 / 13	1,5	8	-0,95	8		

numatics			15-DIGIT PRODUCT CODE		
(14) (12)		with impulse manual operator	with maintained manual operator	without manual operator	
(Rubber packed)					
2 x 3/2 NC	K		R502A2BD0MA00F1	R502A2BD0M11BF1	R502A2BD0M11MF1
(Spool & Sleeve)					
5/2 			R502A1B10MA00F1	R502A1B10M11BF1	R502A1B10M11MF1
			R502A1BN0NA00F1	R502A1BN0M11BF1	R502A1BN0M11MF1
			R502A1B40MA00F1	R502A1B40M11BF1	R502A1B40M11MF1
5/3 			R502A1B60MA00F1	R502A1B60M11BF1	R502A1B60M11MF1
			R502A1B70MA00F1	R502A1B70M11BF1	R502A1B70M11MF1
			R502A1B50MA00F1	R502A1B50M11BF1	R502A1B50M11MF1

AIR QUALITY [ISO 8573-1 (2010)]: Level 7.4.4



40 μm ↔ 5 μm

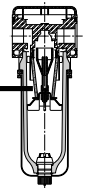

numatics

502

25 Pin Sub-D:
SGL = 22 max. / DBL = 11 max.
37 Pin Sub-D:
SGL = 32 max. / DBL = 16 max.

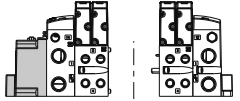

19 Pin Round Connector:
SGL = 16 max. / DBL = 8 max.

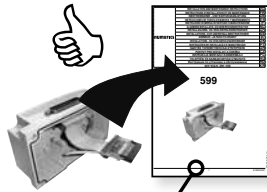
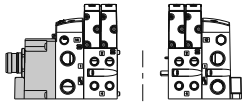

1-32 Terminal Strip:
SGL = 32 max. / DBL = 16 max.

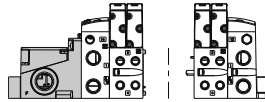

26 Pin Round Connector:
SGL = 22 max. / DBL = 11 max.

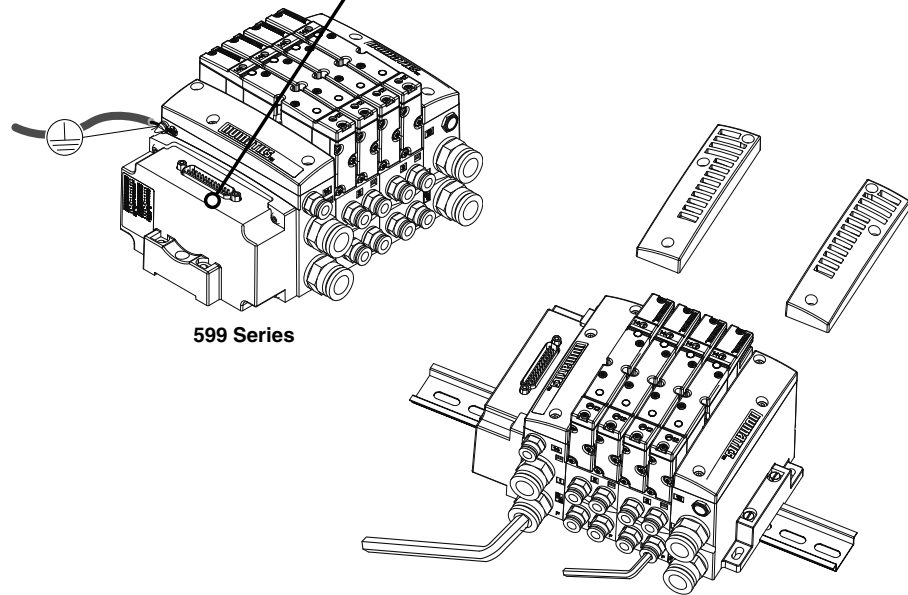
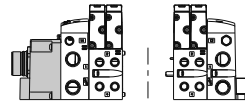

599 Series

numatics

502

G3 → 502

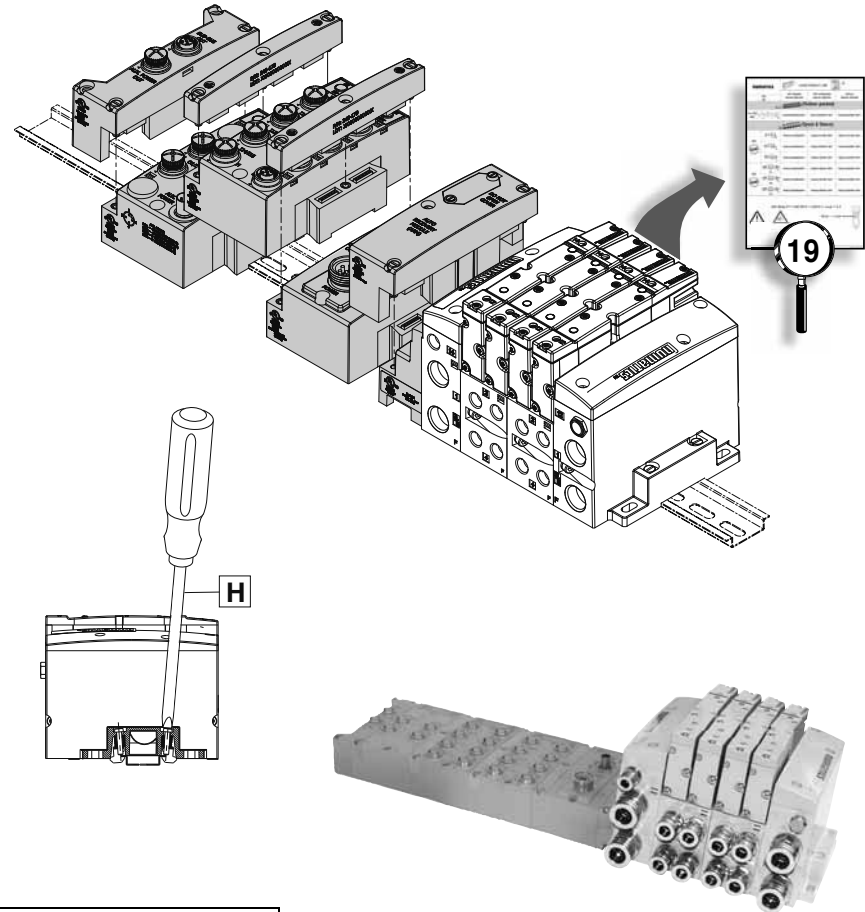

19

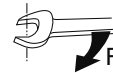
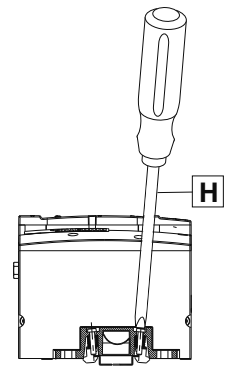

items	N.m	Inch.pounds
H	2.65	23.4

numatics
502



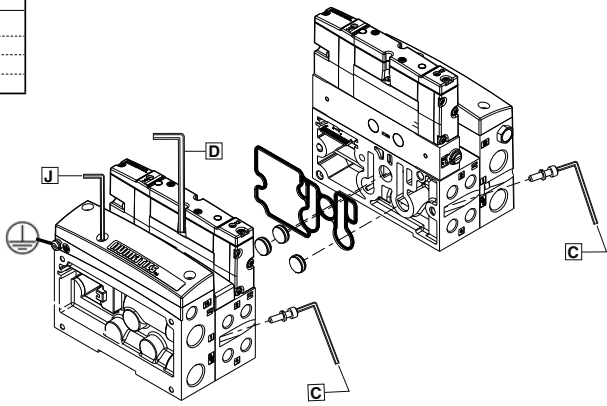

items	N.m	Inch.pounds
C	4.6 ± 10%	40.7 ± 4.1
D	2.0 ± 10%	17.7 ± 1.8
J	2.4 ± 10%	21.0 ± 2.1



Kit

P502AB431813001

P502AD431914001		+		•	1
P502AD431914002		+		•	3
P502AD431914003		+		•	5
P502AD431914004		+		•	1, 3
P502AD431914005		+		•	1, 5
P502AD431914006		+		•	3, 5
P502AD431914007		+		•	1, 3, 5

numatics
502



G (ISO 228/1)	1/8	6 mm	6 mm	Kit
				G502AK431477013
				K502AK431477015
				K502AK431477017
				G502AK431477014
				K502AK431477016
				K502AK431477018
				G502AK431477019
				K502AK431477021
				K502AK431477023
				G502AK431477020
				K502AK431477022
				K502AK431477024

numatics
502



NPT	1/8	1/4 PF	1/4 PF	Kit	
3/8	3/8 PF	1/2 PF			8502AK431477001
					K502AK431477005
					K502AK431477003
					8502AK431477002
					K502AK431477006
					K502AK431477004
					8502AK431477007
					K502AK431477011
					K502AK431477009
					8502AK431477008
					K502AK431477012
					K502AK431477010

numatics
502

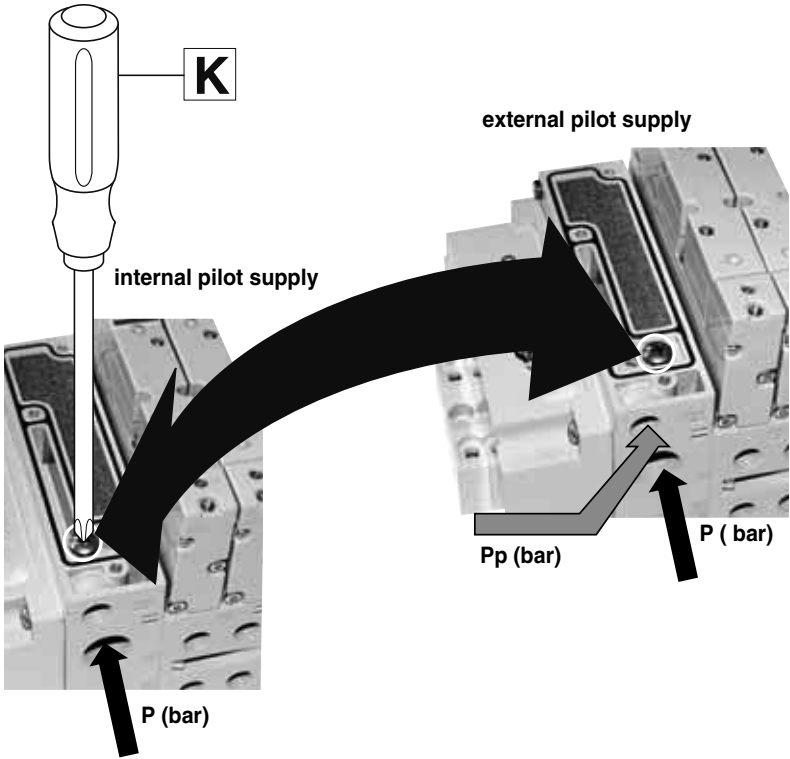
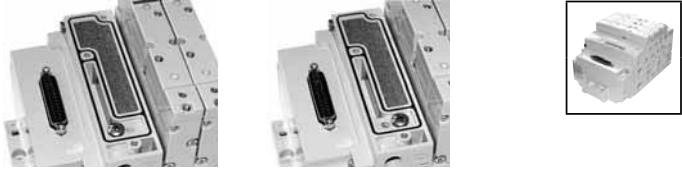

items	N.m	Inch.pounds
K	2,6 ±10%	23 ± 2.3

numatics

502

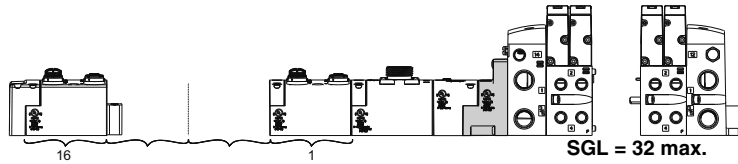

SGL = 32 max.
DBL = 16 max.

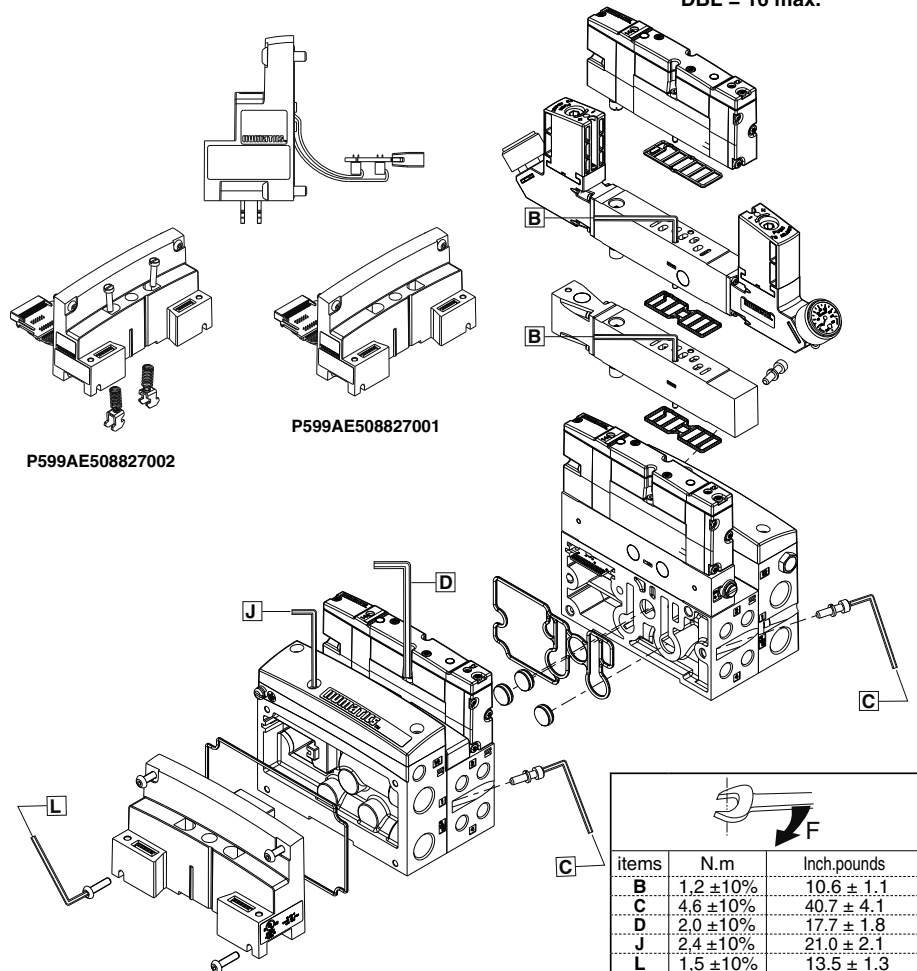

items	N.m	Inch.pounds
B	1,2 ±10%	10,6 ± 1.1
C	4,6 ±10%	40,7 ± 4.1
D	2,0 ±10%	17,7 ± 1.8
J	2,4 ±10%	21,0 ± 2.1
L	1,5 ±10%	13,5 ± 1.3

numatics

502

G3 / 580 / 599

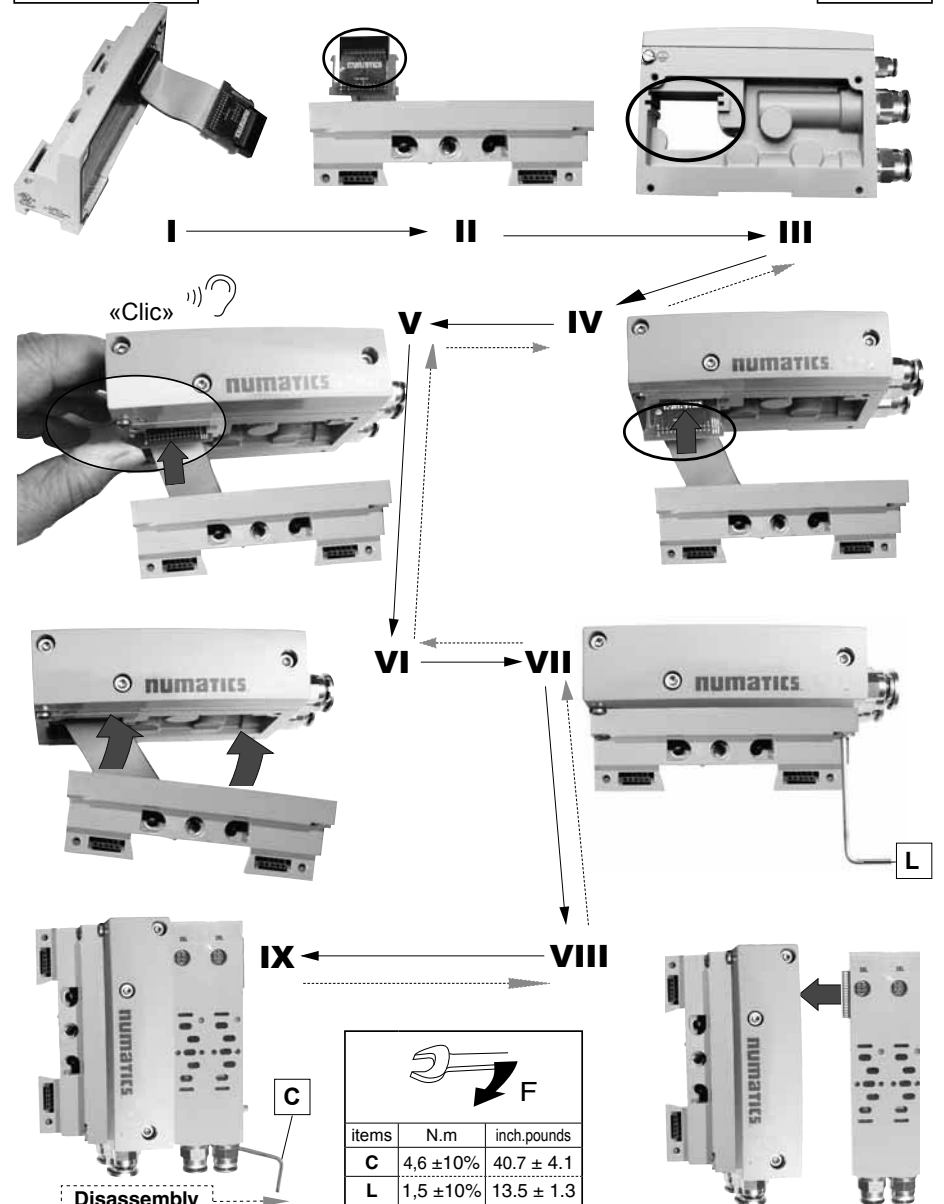

items	N.m	inch.pounds
C	4,6 ±10%	40,7 ± 4.1
L	1,5 ±10%	13,5 ± 1.3

Disassembly

numatics
502

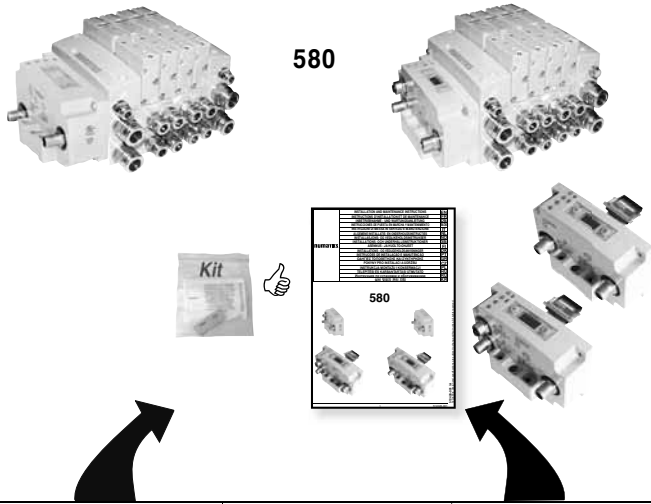

	CANopen®		POWERLINK
	DeviceNet™		Ethernet/IP™
	PROFIBUS-DP®		EtherCAT®
	EtherNET/IP™ DLR		PROFINET®
	SUB-BUS		CHARM
	IO-Link Class A (4 pin)		IO-Link Class B (5 pin)

numatics
502



		R502AY429409002	
	G1/4 NPT 1/4 	G502AW428685004 US ▶ 8502AW428685004	
	G1/4 NPT 1/4 	G502AX428685002 US ▶ 8502AX428685002	
		R502AS429395002	
		R502AY429409001	
	G1/4 NPT 1/4 	G502AW428685003 US ▶ 8502AW428685003	
	G1/4 NPT 1/4 	G502AX428685001 US ▶ 8502AX428685001	
		R502AS429395001	
		G502AP428685005 US ▶ 8502AP428685005	
		G502AP428685006 US ▶ 8502AP428685006	

numatics

502



High flow
0,7 ... 9 bar



numatics

502



High flow
10 ... 130 psig

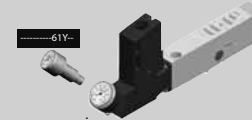
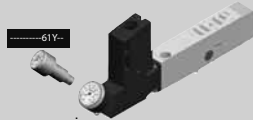

R502ARS12JA0010	RS			
R502ARS12J61Y10	RS...A00.		
R502ARD12J16P10	RD			
R502ARD12J63L10	RD...16P..		
R502ARD12J16N10				
R502ARD12J63M10	RD...16N..		
R502ARD12JA0010	RD...A00..		
R502ARD12J61Y10				
R502ARE12J16P10	RE			
R502ARE12J63L10	RE...16P..		
R502ARE12J16N10				
R502ARE12J63M10	RE...16N..		
R502ARE12JA0010	RE...A00..		
R502ARE12J61Y10				
R502ART12J16P10	RT			
R502ART12J63L10	RT...16P..		
R502ART12J16N10				
R502ART12J63M10	RT...16N..		
R502ART12JA0010	RT...A00..		
R502ART12J61Y10				

R502ARS11JA0010	RS			
R502ARS11J61Y10	RS...A00.		
R502ARD11J16P10	RD			
R502ARD11J63L10	RD...16P..		
R502ARD11J16N10				
R502ARD11J63M10	RD...16N..		
R502ARD11JA0010	RD...A00..		
R502ARD11J61Y10				
R502ARE11J16P10	RE			
R502ARE11J63L10	RE...16P..		
R502ARE11J16N10				
R502ARE11J63M10	RE...16N..		
R502ARE11JA0010	RE...A00..		
R502ARE11J61Y10				
R502ART11J16P10	RT			
R502ART11J63L10	RT...16P..		
R502ART11J16N10				
R502ART11J63M10	RT...16N..		
R502ART11JA0010	RT...A00..		
R502ART11J61Y10				

numatics
502



ISO 15407-2
18 mm
0,7 ... 9 bar



numatics
502



ISO 15407-2
18 mm
10 ... 130 psig

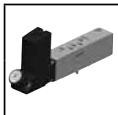

R502ARS12JA0020 R502ARS12J61Y20	RS	<p>....RS...A00.</p>	
R502ARD12J16P20 R502ARD12J63L20 R502ARD12J16N20 R502ARD12J63M20 R502ARD12JA0020 R502ARD12J61Y20	RD	<p>....RD...16P..</p>	<p>....RD...16N..</p>
		<p>....RD...A00..</p>	
R502ARE12J16P20 R502ARE12J63L20 R502ARE12J16N20 R502ARE12J63M20 R502ARE12JA0020 R502ARE12J61Y20	RE	<p>....RE...16P..</p>	<p>....RE...16N..</p>
		<p>....RE...A00..</p>	
R502ART12J16P20 R502ART12J63L20 R502ART12J16N20 R502ART12J63M20 R502ART12JA0020 R502ART12J61Y20	RT	<p>....RT...16P..</p>	<p>....RT...16N..</p>
		<p>....RT...A00..</p>	

R502ARS11JA0020 R502ARS11J61Y20	RS	<p>....RS...A00.</p>	
R502ARD11J16P20 R502ARD11J63L20 R502ARD11J16N20 R502ARD11J63M20 R502ARD11JA0020 R502ARD11J61Y20	RD	<p>....RD...16P..</p>	<p>....RD...16N..</p>
		<p>....RD...A00..</p>	
R502ARE11J16P20 R502ARE11J63L20 R502ARE11J16N20 R502ARE11J63M20 R502ARE11JA0020 R502ARE11J61Y20	RE	<p>....RE...16P..</p>	<p>....RE...16N..</p>
		<p>....RE...A00..</p>	
R502ART11J16P20 R502ART11J63L20 R502ART11J16N20 R502ART11J63M20 R502ART11JA0020 R502ART11J61Y20	RT	<p>....RT...16P..</p>	<p>....RT...16N..</p>
		<p>....RT...A00..</p>	

numatics

502

ACCESSORY ZONED POWER (24 VDC Separation)



WIRING DIAGRAM

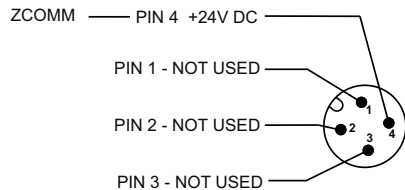

8 G 502AM S M 2 3 V HW A00 1 2 0 K

Table with 2 columns: Language (EN, FR, DE, ES, IT, NL, NO, SE, FI, DK, PT, GR, CZ, PL, HU, RU, KZ) and Description in the respective language.

numatics

502

ACCESSORY ZONED POWER (24 VDC Separation)

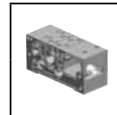

8 G 502AM S M 2 3 V HW A00 1 2 0 K



ISO 13849

Table with 2 columns: Language (EN, FR, DE, ES, IT, NL, NO, SE) and Description in the respective language, including safety standards and application details.

numatics

502



ACCESSORY
ZONED POWER (24 VDC Separation)

8 G 502AM S 2 3 V M HW A00 1 2 0 K



ISO 13849



numatics

CE

ACCESSORY
MID STATION SUPPLY AND EXHAUST
503 double Z-board, 15407-2 double Z-board and
15407-1 no Zboard

502

- FI Zoned Power pneumaattista saarekkeita voidaan käyttää osana turvallisuuteen liittyvää ohjausjärjestelmää (SRP/CS) ISO 13849 -standardien mukaisesti...
DK Pneumatiske Zoned Power-grupper kan anvendes som del af et SRP/CS-system (Safety Related Product of a Control System) overensstemmende med ISO 13849-sikkerhedsstandarderne...
PT Pode utilizar as ilhas pneumáticas de Potência Dividida em Zonas como parte de um sistema de controlo relacionado com a segurança (SRP/CS) em conformidade com as normas ISO 13849 até à Categoria 3 / PLd se forem utilizadas com um controlo de segurança externo adequado...
GR Οι pneυματικές μονάδες Zoned Power μπορούν να χρησιμοποιηθούν ως Σύστημα Ελέγχου για θέματα Ασφαλείας (SRP/CS) σε συμμόρφωση με τα πρότυπα του ISO 13849 έως την Κατηγορία 3 / PLd εφόσον χρησιμοποιούνται μαζί με κατάλληλο έλεγχο εξωτερικής ασφαλείας...
CZ Pneumatické ostrovy Zoned Power mohou být použity jako součást řídicího systému souvisejícího s bezpečností (SRP/CS) v souladu s normami ISO 13849 až do kategorie 3/PLd, pokud jsou používány s příslušnou vnější kontrolou bezpečnosti...
PL Wyspy pneumatyczne mocy sterowej można stosować jako część systemu sterowania związanego z bezpieczeństwem (SRP/CS) zgodnie z normami ISO 13849 do kategorii 3 / PLd, jeśli zostaną zastosowane z odpowiednim zewnętrznym sterowaniem bezpieczeństwa...
HU A Zoned Power pneumatikus szigeték biztonságos kapcsolatos ellenőrzési rendszerek (SRP/CS) részeként használhatók, az ISO 13849 szabvány betartása mellett a 3. kategóriás/PLd rendszerig, amennyiben a megfelelő külső biztonsági ellenőrzéssel...
RU В качестве элемента системы контроля, связанной с безопасностью (SRP/CS), можно использовать пневмоострова с зонированным питанием согласно стандартам ISO 13849 вплоть до категории 3/PLd, если это сочетается с соответствующими внешними мерами по контролю безопасности...
KZ Кватты қамтамасыз ететін, аймақтарға белінген пневматикалық блоктар қауіпсіздікті қамтамасыз етуге арналған тиісті элементтермен (мысалы, бақылау, уақытты белгілеу, импульс сынағы, т.б.) бірге пайдаланылса және барлық байланысты қауіпсіздік стандарттарына сәйкес пайдаланылса, оларды ISO 13849 стандартына сәйкес 3-санат/PLd деңгейіне дейінгі қауіпсіздікке қатысты басқару жүйесінің (SRP/CS) бір бөлігі ретінде пайдалануға болады...

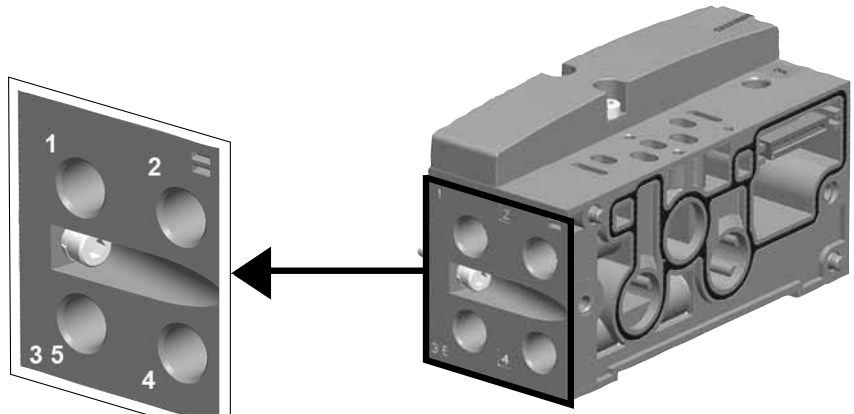

8 G 502AZ M 22 M A00 1 2 0 K 3

