

HART® Field Device Specification

Fisher™ FIELDVUE™ DVC6200 SIS Digital Valve Controller

HART Revision	Device Type	Device Revision	Firmware Revision
HART 5	0a	1	3, 4, 5, 6, 7
HART 7	130a	2	3, 4, 5, 6
		3	7

Contents

- Introduction 2
 - Product Overview 2
 - Purpose of this document 2
 - Abbreviations and definitions 2
 - Reference Documentation 3
- Device Identification 3
- Product Interfaces 4
 - Control Valve Interface 4
 - Host interface 4
 - Pushbutton Calibration 4
 - Internal Jumpers And Switches 5
 - Write Protection 5
- Dynamic Variables 6
- Device Variables 6
- Unit Codes 7
- Status Information 7
 - Device Status 7
- Universal Commands 8
- Common-Practice Commands 16
 - Burst Mode 16
 - Condensed Status 16
- Device-Specific Commands 22
- Performance 22
- Annex A Compatibility Checklist 23
- Annex B DVC6200 SIS Parameters as part of a
Rosemount™ 1410/1420 WirelessHART®
Gateway 24



Introduction

Product Overview

The FIELDVUE DVC6200 SIS digital valve controller is designed to control the pneumatic actuator of a safety valve. It receives a current signal from a host and uses instrument air supply to create a metered pressure output signal to the pneumatic actuator. Movement of the actuator as it positions the safety valve is measured by the DVC6200 SIS travel sensor as its primary feedback. The name plate is located on the bottom side of the DVC6200 SIS master module assembly and indicates the model name, individual product serial number, and any applicable third party approvals.

Purpose of this document

This specification is designed to be a technical reference for HART capable host application developers, system integrators and knowledgeable end-users. It also provides functional specifications (e.g., commands, enumerations and performance requirements) used during field device development, maintenance and testing. This document assumes the reader is familiar with HART Protocol requirements and terminology. Additional product information is available in DVC6200 SIS product literature, available from Emerson Automation Solutions.

Abbreviations and definitions

AR	Alert Record
Configuration Variables	Variables which represent nonvolatile values of manufacturing-initialized data or user-specified configuration information. These variables cannot be enumerated via Command 54 and as such stand on their own with no associated units or range information.
Device Variable	Measured variables that are exposed to HART and can be enumerated using Command 54. Generally there are variables whose ID is in the range of 0 to 13 and are associated with units codes, status, and range values.
Enumeration	A pre-defined set of values or text.
MV	Measured Variable, a physical input to the instrument.
NV	Named Variable – a logical point inside the device, hard-mapped to a given MV as the source of NV data.
Point	A term that applies to diagnostic data packets. It is defined as a collection of periodically sampled variables captured at a single instant in time. It does not include the “Monitor” point.
PS1	The PORT A output pressure which increases with increasing drive signal.
PS2	The PORT B output pressure which decreases with increasing drive signal.
PST	Partial Stroke Test, a limited form of ramped valve diagnostic.
SIS	Safety Instrumented Systems (formerly called ESD or Emergency Shutdown)
Byte	An 8-bit unsigned integer.
Word	A 16-bit unsigned integer.
Float	Refers to the IEEE 754 floating point format.
Packed ASCII	A special form of characters defined by HART in which 6-bit ASCII characters are packed into byte data.
Standard Span Format	A proprietary 16-bit integer format for numerical values used by some of this device’s Device Specific commands.

Reference Documentation

HART Smart Communications Protocol Specification Revision 7.6; a group of documents specifying the HART Communication Protocol, physical layers, and Data Link Layers as defined by the HART Communications Foundation.

Bulletin 62.1:DVC6200 SIS Fisher FIELDVUE DVC6200 SIS Digital Valve Controller ([D103555X012](#))

Fisher FIELDVUE DVC6200 Series Digital Valve Controllers Quick Start Guide ([D103556X012](#))

Fisher FIELDVUE DVC6200 SIS Digital Valve Controller Instruction Manual ([D103557X012](#))

Device Identification

Manufacturer Name	Fisher Controls	Model Name(s)	DVC6200 SIS	
Manufacture ID Code	19	(13 Hex)	Device Type Code	10
				(0a Hex)
HART Protocol Revision	7.6		Device Revision	2 & 3
User Selectable HART Revision between HART 5 and HART 7	Yes			
Number of Device Variables	13			
Physical Layers Supported	FSK			
Physical Device Category	Valve Positioner			

Product Interfaces

Control Valve Interface

The DVC6200 SIS digital valve controller is mechanically attached to the valve's actuator by means of a mounting bracket. The valve's position is conveyed to the travel sensor of the DVC6200 SIS digital valve controller by means of the feedback bracket and magnet assembly attached to the actuator's stem.

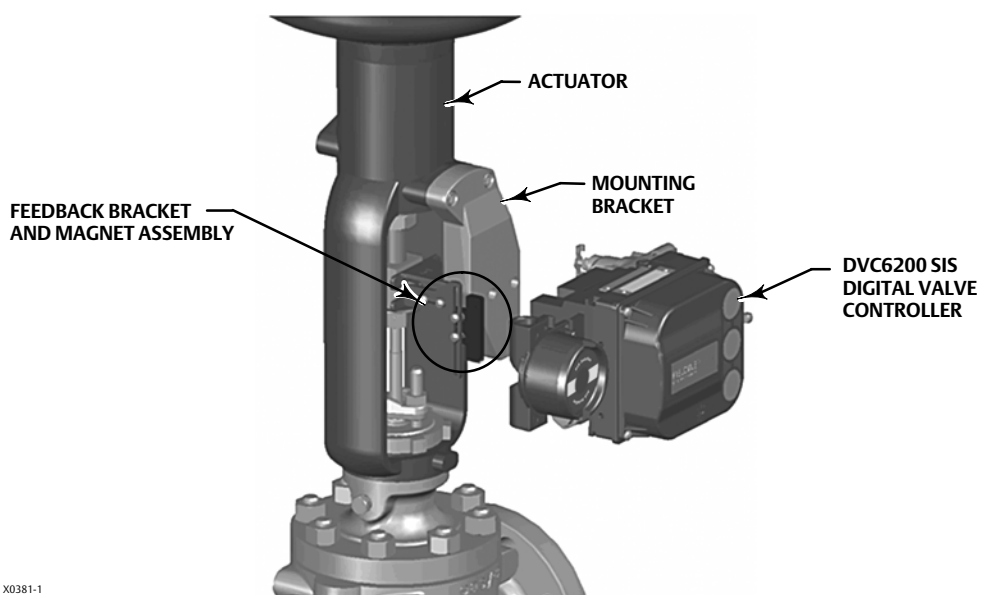

Pneumatic tubing connected to the DVC6200 SIS brings instrument supply air to the DVC6200 SIS and takes controlled output air from the DVC6200 SIS to the actuator. Pressure sensors in the DVC6200 SIS measure these pressure signals and present them as device variables

Host interface

The input to the DVC6200 SIS can either be two-wire 4-to-20 mA current loop (in point-to-point mode) or 24 VDC (in multi-drop mode). This input is connected in the DVC6200's terminal box on two terminals marked "LOOP +" and "LOOP -". Refer to the DVC6200 Series quick start guide for connection details.

Pushbutton Calibration

A pushbutton near the wiring terminals in the terminal box provides a quick means to autocalibrate the travel of the instrument. The button must be pressed for 3 to 10 seconds. Autocalibration will move the valve through the full range of travel whether the Instrument Mode is In Service or Out of Service. However, if the Write Protection is Protected, this button will not be active. To abort, press the button again for 1 second. The calibration button is disabled by default.

Internal Jumpers And Switches

The input to the DVC6200 SIS is determined by the Pt-Pt/Multi-Drop switch on the printed wiring board.

The DVC6200 SIS also has a pair of “Output” terminals that can either function as a position transmitter or a discrete switch. Electronic configuration of the output circuit requires the proper setting of a DIP switch on the DVC6200’s printed wiring board. Additionally, the functional operation of the output circuit must be configured with the user interface.

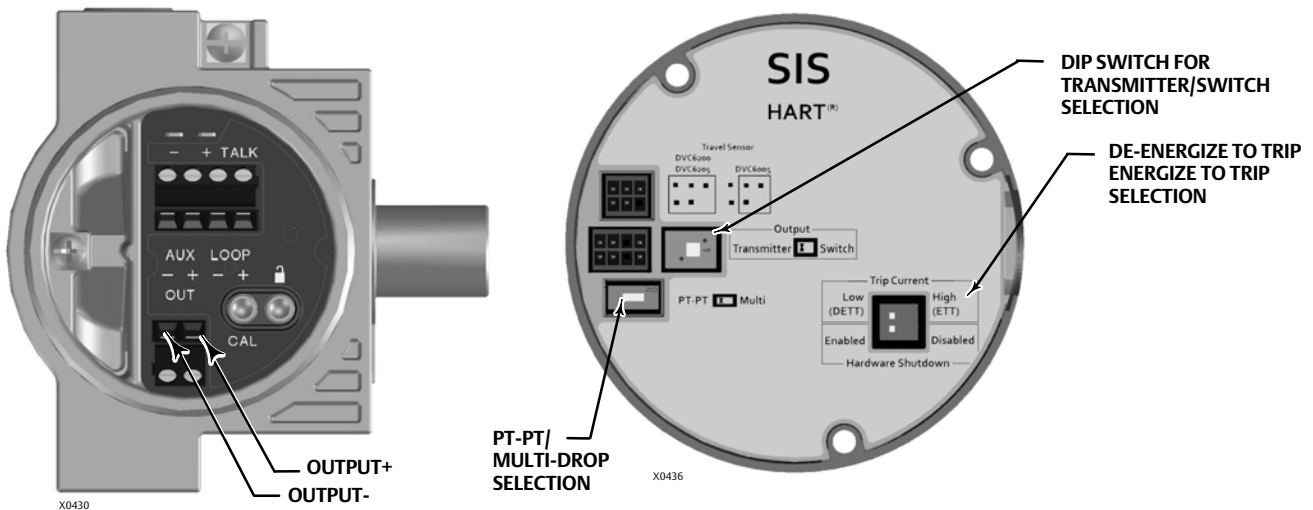

The DVC6200 SIS has an analog shutdown circuit built into the electronics construction. This circuit enables the DVC6200 SIS to perform the safety function through electronics hardware, independent from the device firmware. This function is controlled by two DIP switches:

One switch enables or disables the hardware shutdown feature.

The other switch to choose either to de-energize-to-trip (labeled “Trip Current Low (DETT)”) or energize-to-trip (labeled “Trip Current High (ETT)”).

The cutoff point is 12 mA +/- 5% and is not configurable. DETT is the standard configuration for direct acting applications. Energize-to-trip (ETT) is the standard configuration for reverse acting applications.

Refer to the DVC6200 SIS instruction manual for additional details on the settings of the selection switches.

Write Protection

There are two Write Protection states for the DVC6200 SIS: Not Protected or Protected. Protected prevents configuration and calibration changes to the instrument. The default setting is Not Protected. Protection is controlled under software control. Write Protection can be enabled remotely. However, to disable Write Protection to Not Protected, you must have physical access to the instrument. The procedure will require you to press a button inside the terminal box when directed by the software as a security measure.

Dynamic Variables

Four Dynamic Variables are implemented.

	Default Meaning	Units
PV	Analog Input	mA, %
SV*	Travel Setpoint	%
TV*	Pressure	PSI, BAR, KPA, Kg/cm ²
FV*	Travel	%

* User selectable

The SV, TV, and FV variables are user selectable via Command 51 to any of the following variables. Variable selections are listed below:

Variable	Units
Travel	%
Travel Setpoint	%
Pressure Port A	PSI, BAR, KPA, Kg/cm ²
Pressure Port B	PSI, BAR, KPA, Kg/cm ²
Pressure A – B	PSI, BAR, KPA, Kg/cm ²
Supply Pressure	PSI, BAR, KPA, Kg/cm ²
Drive Signal	%
Analog Input	mA, %

Device Variables

These variables represent measurements taken by the device, are read only values, and are all in float format. These can be read with Commands 9, 33, and 54.

Variable ID	Meaning	Units
0	Analog Input	mA, %
1	Internal Temperature	°C, °F
2	Pressure Port A	PSI, BAR, KPA, Kg/cm ²
3	Travel	%
4	Drive Signal	%
5	Pressure Port B	PSI, BAR, KPA, Kg/cm ²
6	Travel Setpoint	%
7	Differential Pressure (Port A – Port B)	PSI, BAR, KPA, Kg/cm ²
8	Supply Pressure	PSI, BAR, KPA, Kg/cm ²
9	Implied Valve Position	%
10	Primary Feedback (user selected, either Travel or Pressure)	%
11	Friction	As defined in ValveLink software
12	Deadband	As defined in ValveLink software
13	Stroke Time	seconds

Unit Codes

Variable Units Code	Units
0	No Units
6	Pounds per square inch, psi
7	Bar
10 (\$0A)	Kilograms per square centimeter, kg/cm ²
12 (\$0C)	Kilopascals, kPa
32 (\$20)	Celsius, °C
33 (\$21)	Fahrenheit, °F
39 (\$27)	Milliamps, mA
57 (\$39)	Percent, %

Status Information

Device Status

The Field Device Status Byte is the only status byte defined in the HART protocol. The order and meaning of each of the eight bits within the byte are fixed by the protocol. This byte is one of the status bytes included with each HART response. It is not part of the Command 48 data.

Bit	Name of Status Bit	Meaning
7	Field Device Malfunction	Set / cleared by the firmware based on self test results. This bit is set if the pressure, position or temperature sensors provide invalid readings.
6	Configuration Changed	Two such bits exist internally, one for each HART master. Both copies are set when any variable, HART message, tag, descriptor or date are changed from HART. Cleared by command 38, separately for each master. This bit survives loss of power.
5	Cold Start	Set by the firmware whenever a RESET sequence is executed or at initial device power up. Cleared by the first HART command. Two such bits exist internally, one for each HART master.
4	More Status	Active when any bit in command 48 is active.
3	Analog Input Fixed	Active if the Instrument Mode of the DVC6200 SIS is in the “Out Of Service” condition or if the Control Mode of the DVC6200 SIS is in one of the digital set point modes.
2	Analog Input Saturated	The loop current reading is beyond sensor limits.
1	Internal Sensor Out of Limits	(This bit is named “Non-Primary Variable Out Of Limits” in the HART documentation for transmitters. It has been renamed to reflect the fact that these variables are INTERNAL INPUTS to FIELDVUE products). The firmware sets this bit when any sensor (pressure, position, temperature) exceeds its operating limits.
0	Variable Out of Range	Set when any variable 0, 1, 2, 3, 5, 8 or 10, is saturated.

Universal Commands

The DVC6200 SIS field device implements all Universal Commands. Commands 14, 15, 17, 48 are listed below to indicate their unique responses.

Command 0: Read Unique Identifier

Command 1: Read Primary Variable

Command 2: Read Primary Variable (current) and Percent of Range

Command 3: Read Dynamic Variables and Primary Variable (current)

Command 6: Write Polling Address

* Command 7: Read Loop Configuration

* Command 8: Read Dynamic Variable Classifications

* Command 9: Read Device Variable with Status

Command 11: Read Unique Identifier Associated with Tag

Command 12: Read Message

Command 13: Read Tag, Descriptor, Date

Command 14: Read Primary Variable Transducer Information

Command 15: Read Primary Variable Output Information

Command 16: Read Final Assembly Number

Command 17: Write Message

Command 18: Write Tag, Descriptor, Date

Command 19: Write Final Assembly Number

* Command 20: Read Long Tag

* Command 21: Read Unique Identifier Associated with Long Tag

* Command 22: Write Long Tag

Command 38: Reset Configuration Changed Flag

Command 48: Read Additional Status

* Commands 7, 8, 9, 20, 21, and 22 are HART 7 only.

Command 14: Read Primary Variable Transducer Information

The transducer limits reported in this command are either 4-20 milliamps, or 0-100%, and reflect the units code most recently supplied in command 44.

Note

The Transducer Serial Number is not applicable to the DVC6200 SIS and is set to "0".

	Byte	Format	Description	Returned Value
Request Data bytes	None			
Response Data Bytes	0-2	UINT24	Transducer Serial Number	000000
	3	Enum	Transducer Limits and Minimum Span Units Code	From Cmd 44
	4-7	Float	Upper Transducer Limit	20mA
	8-11	Float	Lower Transducer Limit	4.0mA
	12-15	Float	Minimum Span	1.0mA
	Code	Class	Description	
Response Codes	None			

Command 15: Read Primary Variable Output Information

This command returns the upper/lower range values for the primary variable which is defined to be the loop current signal. These are the loop current values for the ends of physical travel, and are used to derive set point from the loop current. It reports the range supplied in Command 35.

For example, the lower range, for an increase to open valve, will be the current which will produce a 0% set point. However, for an increase to close valve, the lower range will be the loop current for a 100% set point.

The range values can be changed via Command 35.

The DVC6200 SIS assumes 0% = 4mA and 100% = 20mA.

	Byte	Format	Description	Returned Value
Request Data bytes	None			
Response Data Bytes	0	Enum	PV Alarm Selection Code. The Alarm Selection Code indicates the action taken by the device under error conditions. For Actuators, the action taken by the positioner is indicated.	250 (Not Used)
	1	Enum	PV Transfer Function Code. The Transfer Function Code must return "0", Linear, if transfer functions are not supported by the device.	250 (Not Used)
	2	Enum	AI Upper and Lower Range Values Units Code, as supplied in command 35.	From CMD 35
	3-6	Float	AI Upper Range Value	From Cmd 35
	7-10	Float	AI Lower Range Value	From Cmd 35
	11-14	Float	PV Damping Value (units of seconds)	0.0
	15	Enum	Write Protect Code (0=Disabled, 1=Enabled)	0 or 1
	16	Enum	Reserved. Must be set to "250", Not Used.	250
	17	Uint8	PV Analog Channel Flags	01
	Code	Class	Description	
Additional Device-Related Response Codes	None			

Command 17: Write Message

This command allows you to write a 24 character informational message into the device.

However, per common implementation of Emerson devices, writing a specific string to the Message field will signal the device to transition operation from HART 5 to HART 7 mode and vice versa. The original message in the device will not be altered if these strings are encountered.

To switch HART versions, send one of the following strings.

To switch to HART 5 mode: send “HART5”.

To switch to HART 7 mode: send “HART7”.

	Byte	Format	Description
Request Data bytes	0-23	Packed	A message string used by the master for HART Mode switching. HART 7 20 14 94 DE 08 20 82 08 20 82 08 20 82 08 20 82 08 20 82 08 20 82 08 20 HART 5 20 14 94 D6 08 20 82 08 20 82 08 20 82 08 20 82 08 20 82 08 20 82 08 20
Response Data Bytes	0-23	Packed	Message String
	Code	Class	Description
Command-Related Response Codes	0	Success	No command specific errors
	5	Error	Too few data bytes
	6	Error	Device Specific command error
	7	Error	In write protect mode
	16	Error	Access Restricted
	32	Error	Busy

Command 48: Read Additional Status

This command was significantly revised in HART 7, but can operate in backward compatible mode for HART 5 masters which do not supply data bytes in the request.

Supplying data bytes allows you to acknowledge the current status, and cause the more_status bit to be withdrawn until some status bit changes value.

Exactly 0 or 9 data bytes must be supplied. If supplied, the data must exactly match the current command 48 response in order for the more_status bit to be withdrawn.

	Byte	Format	Description
Request Data bytes	0 or 9		None or nine bytes of status.
Response Data Bytes	0	Uint8	Command 48 Response Byte 0
	1	Uint8	Command 48 Response Byte 1
	2	Uint8	Command 48 Response Byte 2
	3	Uint8	Command 48 Response Byte 3
	4	Uint8	Command 48 Response Byte 4
	5	Uint8	Command 48 Response Byte 5
	6	Uint8	HART 7 Extended Field Device Status byte
	7	Uint8	HART 7 Operating Mode byte
	8	Uint8	HART 7 Standardized Status 0 byte
	9 ⁽¹⁾	Uint8	HART 7 Standardized Status 1 byte
	Code	Class	Description
Command - specific Response Codes	5	Too few data bytes	$0 < x < 9$, or $x > 9$
	14	Data Mismatch	Data was supplied but does not match current status

1. Firmware Revision 7 or higher.

Additional Device Status

Command 48 returns 10 bytes of data, with the following status information:

Byte	Bit	Name of Status Bit	Meaning
0	7	Flash Integrity Failure	Active if there is a failure associated with flash ROM (read only memory).
	6	Minor Loop Sensor Alert	Active if the pneumatic relay position reading is outside the valid range.
	5	Reference Voltage Failure	Active if there is a failure associated with the internal voltage reference.
	4	Drive Current Failure	Active when the drive current to the I/P converter is not flowing as expected.
	3	Critical NVM Failure	Active if there is a failure of non-volatile memory used for configuration data critical for instrument operation.
	2	Temperature Sensor Failure	Active when the instrument temperature sensor fails or the sensor reading is outside of the range of -60° to 100°C (-76° to 212°F).
	1	Pressure Sensor Failure	Active if any of the 3 pressure sensor readings are outside the range of -24.0% to 125.0% of the calibrated pressure for more than 60 seconds.
	0	Travel Sensor Failure	Active if the sensed travel is outside the range of -25.0% to 125.0% of calibrated travel.
1	7	Alert Record Not Empty Alert	Active when there are 1 or more alerts stored in the alert record.
	6	Tripped by the LCP	Active when the DVC6200 SIS is in the tripped position as a result of someone pressing the Trip button on the Local Control Panel (LCP).
	5	Calibration In Progress Alert	Active when calibration is in progress.
	4	Diagnostics in Progress Alert	Active when a diagnostic test is in progress.
	3	Pressure Fallback Active Alert	Active when the instrument has detected a problem with the travel feedback and is now controlling the output like an I/P transducer.
	2	SIS Program Flow Failure	SIS unit is not properly processing the expected series of calculations or if the Instrument Mode is set to the "Out of Service" condition.
	1	NVM Protective Mode ⁽²⁾	Active when excessive NVM writes are detected and further writes to NVM are rejected (to avoid NVM wear-out)
	0	Auto Cal in Progress Alert	Active when auto calibration is in progress.
2	7	SIS Hardware Failure	Active if a safety demand has occurred, but the electronics hardware failed to take control of the I/P drive.
	6	Non-Critical NVM Alert	Active if there is a failure of non-volatile memory used for data not critical for instrument operation.
	5	Cycle Counter High Alert	Active if the Cycle Counter exceeds the Cycle Count Alert Point.
	4	Travel Accumulator High Alert	Active if the Travel Accumulator exceeds the Travel Accumulator Alert Point.
	3	Instrument Time is Approximate Alert	Active if the instrument has been powered down since the last time the instrument clock was set.
	2	Alert Record Full Alert	Active when the alert record contains the maximum number of 20 alerts.
	1	Offline / Failed Alert	Active if a shutdown alert has put the DVC6200 SIS in a failed state.
	0	SIS Stroke Performance Alert	Active if a Trip or Reset stroke time violated the configured threshold.

⁽¹⁾ "Reserved" bits are always set to 0.

⁽²⁾ Firmware Revision 3, 4, 5, & 6 only.

(continued)

Additional Device Status (continued)

Byte	Bit	Name of Status Bit	Meaning
3	7	Diagnostic Data Available Alert	Alert is active when diagnostic data has been collected and is being stored in the instrument.
	6	PST Abnormal	SIS Partial Stroke diagnostic test failed
	5	Supply Pressure Low Alert	Active if the supply pressure falls below the supply pressure low alert point.
	4	End Point Pressure Deviation Alert	Active if the instrument is in pressure control and the pressure is not tracking the set point within the configured deviation allowance.
	3	SIS Locked in Safety Position	Active when the DVC6200 SIS is in the tripped position.
	2	Supply Pressure High Alert ⁽¹⁾	Active if the supply pressure exceeds the supply pressure high alert point.
	1	Integrator Saturated High Alert	Active if the instrument integrator is saturated at the high extreme.
	0	Integrator Saturated Low Alert	Active if the instrument integrator is saturated at the low extreme.
4	7	Travel Alert Lo	Active when the Travel is below the Travel Alert Lo Point.
	6	Travel Alert Lo Lo	Active when the Travel is below the Travel Alert Lo Lo Point.
	5	Travel Alert Hi	Active when the Travel exceeds the Travel Alert Hi Point.
	4	Travel Alert Hi Hi	Active when the Travel exceeds the Travel Alert Hi Hi Point.
	3	Travel Deviation Alert	Active if the difference between the Travel Target and the Travel exceeds the Travel Deviation Alert Point for more than the Travel Deviation Time.
	2	Travel Limit/Cutoff Hi Alert	Active when the Travel exceeds the Hi Limit/Cutoff Point.
	1	Travel Limit/Cutoff Lo Alert	Active when the Travel falls below the Lo Limit/Cutoff Point.
	0	Drive Signal Alert	Active when the Drive Signal exceeds target limits (<10% or >90%) for more than 20 seconds when not in Cutoff condition.
5	7	PST Pass	Active if PST is successful.
	6	PST Reserved	PST was attempted but did not run.
	5	Reserved	
	4	LCP Stuck Button	One of the LCP buttons is stuck.
	3	LCP Communications Failure	Active if the AUX terminals are configured for use with the local control panel (LCP) but communication between the DVC6200 SIS and the LCP is not occurring.
	2	Output Circuit Error	Active if the output circuit is not responding.
	1	Output Pressure Limiting ⁽¹⁾	Active if pneumatic output A exceeds the configured limit.
	0	Reserved	

⁽¹⁾Reserved" bits are always set to 0.

1. Firmware Revision 7 or higher.

(continued)

Additional Device Status (continued)

Byte	Bit	Name of Status Bit	Meaning
6	7	Reserved	Byte 6 is the Extended Field Device Status as defined by the HART Standard. Alerts in Byte 6 are summaries of device-specific alerts from Bytes 0 through 5. Alerts indicated with "N/A" are not available from the DVC6200 SIS instrument. Bit 1: One of the device variables in the list [0,1,2,3,5,8, and 10] is out of the range of -25% to +125% of calibrated span.
	6	Reserved	
	5	Function Check ⁽⁶⁾	
	4	Out of Specification ⁽⁶⁾	
	3	Failure ⁽⁶⁾	
	2	Power Critically Low ⁽⁶⁾	
	1	Device Variable alert ⁽¹⁾	
	0	Maintenance Required ⁽²⁾	
7	7	Reserved	Byte 7 is the Operating Mode, reserved by the HCF, and is always 0.
	6	Reserved	
	5	Reserved	
	4	Reserved	
	3	Reserved	
	2	Reserved	
	1	Reserved	
	0	Reserved	
8	7	Configuration Locked	Byte 8 is the Standardized Status 0 as defined by the HART Standard. Alerts in Byte 8 are summaries of device-specific alerts from Bytes 0 through 5. Alerts indicated with "N/A" are not available from the DVC6200 SIS instrument.
	6	Electronic Defect ⁽³⁾	
	5	Environmental Limit ⁽⁴⁾	
	4	Voltage Error	
	3	Reserved	
	2	RAM Error	
	1	NVM Error ⁽⁵⁾	
0	Variable Simulation Active		
9 ⁽⁶⁾	7	Reserved	Byte 9 is the Standardized Status 1 as defined by the HART Standard. Bit 2: Event Overflow is not supported by the DVC6200 SIS.
	6	Reserved	
	5	Reserved	
	4	Reserved	
	3	Reserved	
	2	Event Overflow	
	1	Reserved	
0	NE107 Simulation Active		

"Reserved" bits are always set to 0.

1. Variable Limited = Variable 0 or 1 or 2 or 3 or 5 or 8 or 10 is outside the range of -25% to 125%
2. Maintenance Required:
 - Firmware Revision 3, 4, 5, & 6 = Cycle Counter Alert or Travel Accumulator Alert or Travel Deviation or Supply Pressure Alert or PST Fail or Drive Signal Alert or Integrator Saturated High or Integrator Saturated Low
 - Firmware Revision 7 or higher = user configurable
3. Electronic Defect = Program memory CRC Error or MLFB Read Back Fail or A/D Reference Error or Drive Current Readback Error or Temperature Sensor Error or Pressure Sensor Error or Position Sensor Error or Program Flow Error or SIS Override Fail or Option Module Error
4. Environmental Limit = Temperature outside -60 to 90 degrees C
5. NVM Error = Critical NVM Checksum Error or Non-Critical NVM Checksum Error
6. Firmware Revision 7 or higher.

Common-Practice Commands

The DVC6200 SIS field device supports the following common practice commands:

- Command 33: Read Device Variables
- Command 35: Write Primary Variable Range Values
- Command 42: Perform Master Reset
- Command 44: Write Primary Variable Units
- Command 50: Read Dynamic Variable Assignments
- Command 51: Write Dynamic Variable Assignments
- Command 52: Set Device Variable Zero
- Command 53: Set Device Variable Units
- Command 54: Read Device Variable Information
- Command 59: Write Number of Response Preambles

Burst Mode⁽¹⁾

- Command 103: Write Burst Period⁽²⁾
- Command 104: Write Burst Trigger⁽²⁾
- Command 105: Read Burst Mode Configuration⁽²⁾
- Command 107: Write Burst Device Variables
- Command 108: Write Burst Mode Command Number
- Command 109: Burst Mode Control

Condensed Status

- Command 523: Read Condensed Status Mapping Array
- Command 524: Write Condensed Status Mapping⁽³⁾
- Command 525: Reset Condensed Status Map⁽³⁾
- Command 526: Write Status Simulation Mode⁽³⁾
- Command 527: Simulate Status Bit⁽⁴⁾

1. Burst Mode is available in HART 5 mode with all Firmware Revisions. Burst Mode is available in HART 7 mode with Firmware Revision 7 or later.
2. Commands 103, 104, and 105 apply to HART 7 mode only.
3. The instrument will reject a write command with error code 6 if the power is critically low or error code 7 if write protection is enabled.
4. The instrument will reject an attempt to enter simulation mode if write protection is enabled. Simulation mode will exit automatically in 15 minutes if the instrument is in service, or remain indefinitely if the instrument is out of service. Simulation mode will exit when the instrument is placed in service.

Command 33: Read Device Variables

This command is used to read the value of up to four selected Device Variables.

The Device Variables and Variable Units Codes are listed on page 6 and 7.

	Byte	Format	Description	Allowable choices
Request Data Bytes	0	Variable ID	Variable assigned to slot #0	See Device Variable on page 6
	1	Variable ID	Variable assigned to slot #1	See Device Variable on page 6
	2	Variable ID	Variable assigned to slot #2	See Device Variable on page 6
	3	Variable ID	Variable assigned to slot #3	See Device Variable on page 6
Response Data Bytes	0	Variable ID	Variable assigned to slot #0	
	1	Byte, hex	Slot #0 Variable units code	
	2-5	Float	Slot #0 Variable value	
	6	Variable ID	Variable assigned to slot #1	
	7	Byte, hex	Slot #1 Variable units code	
	8-11	Float	Slot #1 Variable value	
	12	Variable ID	Variable assigned to slot #2	
	13	Byte, hex	Slot #2 Variable units code	
	14-17	Float	Slot #2 Variable value	
	18	Variable ID	Variable assigned to slot #3	
19	Byte, hex	Slot #3 Variable units code		
20-23	Float	Slot #3 Variable value		
	Code	Class	Description	
Command-Specific Response Codes	0	Success	No Command-Specific Errors	
	2	Error	Invalid selection – Invalid Variable ID	

Command 35: Write Primary Variable Range Values

In the DVC6200 SIS, the Primary Variable is defined to be the Analog Input (loop current).

This command is used to write the ranging values reported in Command 15. It controls how the DVC6200 SIS interprets the loop current when creating the Travel Target. The upper range must be greater than the lower range.

This command does units conversion, accepting range values in milliamps or percent. If the primary variable is not configured to use the same units as supplied in this command, the supplied ranges will be converted to PV units before being applied. Range values are validated against those reported in Command 14 to assure that they are within the allowable range and are separated by a minimum span.

If the range values are in percent, then they are assumed to be percent of 4-20 mA. For example, to range an increase to open unit from 8 mA to 16 mA, but using percent range numbers, specify lower_range = 25% and upper_range = 75%.

This ranging is done in conjunction with the zero power condition. For an Increase-to-Open valve, the lower range is the 0% setpoint level (valve plug in the valve seat), while the upper range is the 100% setpoint level. An Increase-to-Close valve is exactly opposite.

This command will be accepted when the DVC6200 SIS's Instrument Mode is In Service but will be rejected if Write Protection is in effect.

	Byte	Format	Description	Allowable choices
Request Data Bytes	0	UINT8	Upper and Lower Range Values Unit Code	Unit Code 39 (mA) or 57(%)
	1 - 4	Float	Primary Variable Upper Range Value	
	5 - 8	Float	Primary Variable Lower Range Value	
Response Data Bytes	0	UINT8	Upper and Lower Range Values Unit Code	Unit Code 39 (mA) or 57(%)
	1 - 4	Float	Primary Variable Upper Range Value	
	5 - 8	Float	Primary Variable Lower Range Value	
	Code	Class	Description	
Command-Specific Response Codes	0	Success	No Command-Specific Errors	
	2	Error	Invalid selection - Units code not 39 (mA) or 57(%)	
	6	Error	Insufficient power	
	7	Error	In Write Protect Mode	
	9	Error	Lower Range too high	
	10	Error	Lower Range too low	
	11	Error	Upper Range too high	
	12	Error	Upper Range too low	
	13	Error	Both ranges are invalid	
	14	Error	Span is too small	
	16	Error	Access Restricted - other master has access locked.	
	29	Error	Upper range less than lower range	
	32	Error	Busy	
78	Error	NVM Protection Mode		

Command 42: Perform Master Reset

This command will cause the instrument to reset by reading the nonvolatile memory (NVM) data and putting it into effect. All NVM data is written with the exception of the real-time clock, restart mode, and default implied valve position.

	Byte	Format	Description
Request Data bytes	None		
Response Data Bytes	None		

Command 44: Change Primary Variable Units Code

This command is issued to change the units of the Primary Variable, which is defined in the DVC6200 SIS as the Analog Input (loop current). The choices for units are Percent (code 57) or Milliamps (code 39). This command will cause variable 0 (loop current), and the response to Command 14, to be reported in the new units.

In addition to changing the units code, execution of this command will also change the DVC6200 SIS's Analog Input Upper and Lower Range values to reflect the new units. (For example: When the DVC6200 SIS's Analog Input is configured as "4-20 mA" and Command 44 with request Data Byte 57 is executed, the DVC6200 SIS's Analog Input units and range values will change to "0-100%". Likewise, when the DVC6200 SIS's Analog Input is configured as "0-100%" and Command 44 with request Data Byte 39 is executed, the DVC6200 SIS's Analog Input units and range values will change to "4-20 mA").

This command will be accepted when the DVC6200 SIS's Instrument Mode is In Service, but will be rejected if Write Protection is in effect.

	Byte	Format	Description	Allowable choices
Request Data Bytes	0	UINT8	Primary Variable Units Code	Unit Code 39 (mA) or 57(%)
Response Data Bytes	0	UINT8	Primary Variable Units Code	
	Code	Class	Description	
Command-Specific Response Codes	0	Success	No Command-Specific Errors	
	2	Error	Invalid selection - Units code not 39 (mA) or 57(%)	
	6	Error	Insufficient Power	
	7	Error	In Write Protect Mode	
	78	Error	NVM Protective Mode	

Command 50: Read Dynamic Variable Assignments

This command returns a list of four device variable codes, taken from the Device Variables table on page 6, which are returned in Command 3. These Dynamic Variables are specified via Command 51.

	Byte	Format	Description
Request Data Bytes	None		
Response Data Bytes	0	UINT8	ID of variable returned as the first variable (PV) in Command 3
	1	UINT8	ID of variable returned as the second variable (SV) in Command 3
	2	UINT8	ID of variable returned as the third variable (TV) in Command 3
	3	UINT8	ID of variable returned as the fourth variable (FV) in Command 3
	Code	Class	Description
Command-Specific Response Codes	None		

Command 51: Write Dynamic Variable Assignments

This command assigns Device Variables to the Secondary (SV), Tertiary (TV), and Quaternary (QV) Dynamic Variables as returned in Command 3. Note that the Primary Variable (PV) is constrained to be only variable 0 (Analog Input). The variables in SV, TV, and QV can be any Device Variable 0...10 which includes Analog Input, Temperature, all pressure readings, Travel, or Travel Setpoint.

This command is accepted when in service, and is afforded write protection.

	Byte	Format	Description
Request Data Bytes	0	UINT8	Device variable ID assigned to PV (must be variable 0 only)
	1	UINT8	Device variable ID assigned to SV (0-10 inclusive)
	2	UINT8	Device variable ID assigned to TV (0-10 inclusive)
	3	UINT8	Device variable ID assigned to QV (0-10 inclusive)
Response Data Bytes	0	UINT8	Device variable ID assigned to PV
	1	UINT8	Device variable ID assigned to SV
	2	UINT8	Device variable ID assigned to TV
	3	UINT8	Device variable ID assigned to QV
	Code	Class	Description
Command-Specific Response Codes	0	Success	No Command-Specific Errors
	2	Error	Invalid selection (Slot #0 is not 0) or other slots not 0...10.
	6	Error	Insufficient Power
	7	Error	In Write Protect Mode
	16	Error	Access Restricted - other master has access locked.
	78	Error	NVM Protective Mode

Command 52: Set Device Variable Zero

This command is used to force one of the pressure inputs to read 0. To use this for pressure, apply 0 psi to the sensor. Then, send this command, specifying the affected pressure Device Variable. The offset will be adjusted to force the present value to read 0. An error will be generated, and no change applied, if the new value causes a change of more than about 3%.

Supported Variables:

- 2 = Port A Pressure
- 5 = Port B Pressure
- 8 = Supply Pressure

	Byte	Format	Description	Allowable choices
Request Data Bytes	0	UINT8	Device Variable ID	Variable IDs 2, 5, or 8
Response Data Bytes	0	UINT8	Device Variable ID	Variable IDs 2, 5, or 8
	Code	Class	Description	
Command-Specific Response Codes	0	Success	No Command-Specific Errors	
	2	Error	Invalid selection – Unsupported variable ID	
	6	Error	Insufficient Power	
	7	Error	In Write Protect Mode	
	9	Error	Present Value is too high	
	10	Error	Present Value is too low	
	78	Error	NVM Protective Mode	

Command 53: Set Device Variable Units

This command is used to set the units for reporting of the device variables related to the DVC6200 SIS’s temperature or pressure sensors. In addition to changing the units code, execution of this command will also change the device variable’s Upper and Lower Range values to reflect the new units. Units Codes are listed on page 7.

To change the units of PV (Analog Input), variable 0, use Command 44.

Supported variables are:

- 1 = Temperature
- 2 = Port A Pressure
- 5 = Port B Pressure
- 7 = Differential Pressure
- 8 = Supply Pressure

	Byte	Format	Description	Allowable choices
Request Data Bytes	0	UINT8	Device Variable ID	Variable IDs 1, 2, 5, 7, or 8
	1	UINT8	Pressure or Temperature Units Code	
Response Data Bytes	0	UINT8	Device Variable ID	Variable IDs 1, 2, 5, 7, or 8
	1	UINT8	Pressure or Temperature Units Code	
	Code	Class	Description	
Command-Specific Response Codes	0	Success	No Command-Specific Errors	
	6	Error	Insufficient Power	
	7	Error	In Write Protect Mode	
	11	Error	Invalid Variable ID	
	12	Error	Invalid Units Code for the Variable ID provided	
	78	Error	NVM Protective Mode	

Command 54: Read Device Variable Information

This command is used to identify each of the Device Variables, in the range of IDs 0...10 inclusive. Responds with the Sensor Serial Number, Sensor Range Units, Sensor Ranges, Damping Value, and Minimum Span of the selected variable. The variable range values will be in the same units as the variable units.

Items marked by “*” are only supported in HART 7 mode.

	Byte	Format	Description
Request Data Bytes	0	Enum	Device Variable ID, this command is applicable to variables 0-10. All others will return invalid selection
Response Data Bytes	0	UINT8	Device Variable ID
	1-3		Device Variable Sensor Serial Number, 24-bit number (NOT USED - always zero)
	4	UINT8	Device variable units code
	5-8	Float	Device Variable Upper Range
	9-12	Float	Device Variable Lower Range
	13-16	Float	Device Variable Damping Value, (NOT USED - always zero)
	17-20	Float	Device Variable Minimum Span (NOT USED - always zero)
	*21	UINT8	Device Variable Classification
	*22	UINT8	Family Code (NOT USED – always 250)
*23-26	Time	Update period in 1/23 of a millisecond	
	Code	Class	Description
Command-Specific Response Codes	0	Success	No Command-Specific Errors
	2	Error	Invalid Selection

Device-Specific Commands

The DVC6200 SIS field device supports device-specific commands. However, these device-specific commands require use of the ValveLink software application or DD methods and cannot be utilized outside of those controlled environments.

Performance

Refer to the DVC6200 SIS Digital Valve Controller Instruction Manual ([D103557X012](#)) and Product Bulletin 62.1:DVC6200 SIS ([D103555X012](#)) for details on DVC6200 SIS performance.

Annex A Compatibility Checklist

Manufacturer, Model, and Revision	Fisher Controls DVC6200 SIS Device Revision 2 & 3
Device Type	Pneumatic Control Valve Positioner
HART Protocol Revision	7.6
User switchable between HART 5 mode and HART 7 mode?	Yes, either with configuration within DD or with a special string in the Message field.
Device Description Available?	Device Revision 1 is for HART 5 mode. Device Revision 2 & 3 is for HART 7 mode.
Number and type of process connections	None
Number of host connections	Input: Control signal to Loop \pm terminals Output: Transmitter or Switch from Out \pm terminals
Number of Dynamic Variables	4
Mappable Dynamic Variables?	Yes. SV, TV, and FV are mappable. PV is not.
Number of Device Variables	13
Number of Supported Common Practice Commands	10
Burst Mode?	Yes: Device Revision 1 & 3 No: Device Revision 2
Capture Device Variables?	No
Write Protection?	Yes

Annex B DVC6200 SIS Parameters as part of a Rosemount 1410 / 1420 WirelessHART Gateway

A FIELDVUE DVC6200 SIS can join a wireless network through the addition of a Rosemount 775 THUM *WirelessHART* adapter. The wireless adapter acts both as a HART modem for communications coming to the DVC6200 SIS from application software and as an independent master issuing commands periodically to the wired device pertaining to it's status. This independently gathered status information is relayed back to the Rosemount 1410 or 1420 Wireless Gateway and is made available to the user either through viewing the HTML interface or via mapping as "Published Data" parameters via the Gateway's MODBUS or OPC outputs.

For HART 5 devices the PV, SV, TV, and QV variables can be mapped.

For HART 7 devices up to 8 variables can be mapped.

Configure the THUM as follows:

Navigate to Configure > Manual Setup
Under the *Wired Device* tab select *Configure HART Polling*

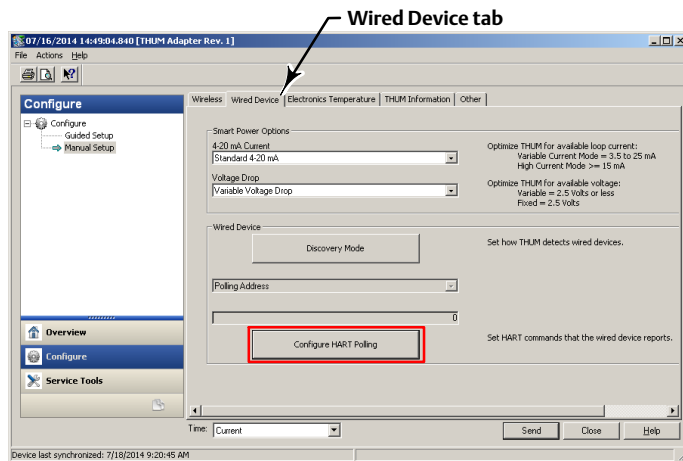

FOR PRIMARY DEVICE INFORMATION:

HART 5 - select PV, SV, TV, and QV

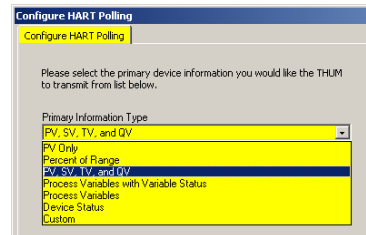

HART 7 - select Process Variables with Variable Status

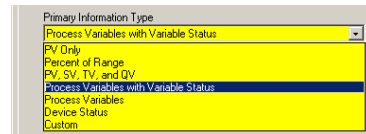

Choose Variables 0, 1, 2, 4, 6, 8, 9, and 10

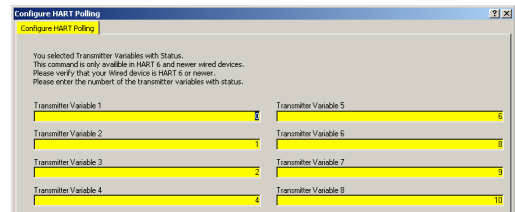

Select Yes if changes are required

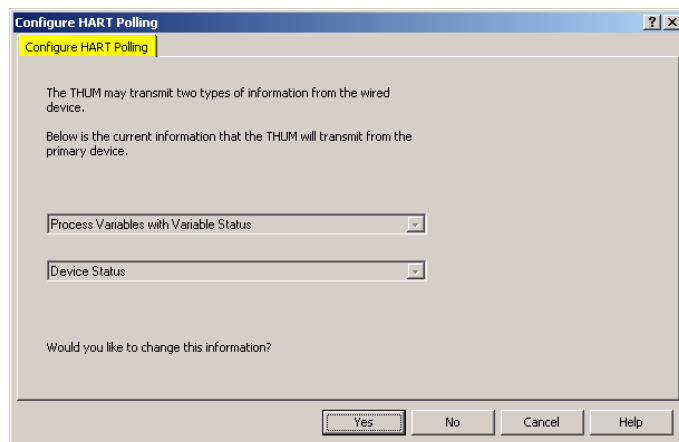

FOR SECONDARY DEVICE INFORMATION:

Both HART 5 and HART 7 - select Device Status

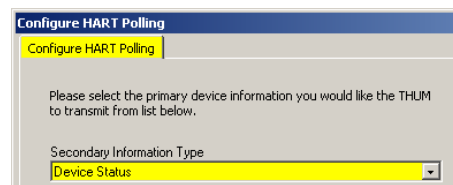

The FIELDVUE instrument is defined on the Gateway by “Tag” (read from the device’s “Message” field).

Smart Wireless Gateway

For each Tag, the Gateway provides updated values for:

- Variables
- Additional Status
- Published Data

HART 5

HART Variables					
Device name		DVC6200 SIS			
Variable	Assignment	Value	Units	Status	Last update
ANALOG_INPUT	PV	19.984	mA	✔ Good, Not limited	05/01/14 15:31:43
PRESSURE_PORT_B	TV	-0.385	PSI	✔ Good, Not limited	05/01/14 15:31:43
PRIMARY_FEEDBACK	QV	100.063	%	✔ Good, Not limited	05/01/14 15:31:43
SV	SV	122.813	%	✔ Good, Not limited	05/01/14 15:31:43
CURRENT	CURRENT	19.984	mA	✔ Good, Not limited	05/01/14 15:31:43

HART 7

HART Variables					
Device name		DVC6200 SIS			
Variable	Assignment	Value	Units	Status	Last update
ANALOG_INPUT	PV	19.984	mA	✔ Good, Not limited	07/16/14 16:28:50
TRAVEL_SETPOINT		59.938	%	✔ Good, Not limited	07/16/14 16:28:50
PRESSURE_PORT_A	TV	14.914	PSI	✔ Good, Not limited	07/16/14 16:28:50
INTERNAL_TEMPERATURE		77.750	DegF	✔ Good, Not limited	07/16/14 16:28:50
DRIVE_SIGNAL		61.375	%	✔ Good, Not limited	07/16/14 16:28:50
SUPPLY_PRESSURE		29.781	PSI	✔ Good, Not limited	07/16/14 16:28:50
IMPLIED_VALVE_POSITION	SV	59.938	%	✔ Good, Not limited	07/16/14 16:28:50
PRIMARY_FEEDBACK	QV	59.656	%	✔ Good, Not limited	07/16/14 16:28:50

Published Data, used for the Gateway’s OPC and Modbus outputs, falls into the following categories:

Field Device Identification Values:

Values that define the identity of the DVC6200 SIS. These include:

- MANUFACTURER (for “Fisher Controls” the value is “19”)
- DEVICE_TYPE
- DEVICE_REVISION
- HARDWARE_REVISION
- SOFTWARE_REVISION
- DEVICE_ID
- UNIVERSAL_REVISION (HART version)
- REQUEST_PREAMBLES
- RESPONSE_PREAMBLES

Variable information:

The Gateway receives updates concerning the DVC6200 SIS’s configured device variables. The information for any given device variable is displayed by:

1. Dynamic Variable indicator (“PV”, “SV”, etc.)
2. The Device Variable ID number assigned to that Dynamic Variable
3. By the Device Variable Name (only if the Gateway has version 4.4 firmware or later)

	Dynamic Variable	Device Variable ID	Device Variable Name(s)
Analog Input	PV	0*	ANALOG_INPUT
Internal Temperature		1	INTERNAL_TEMPERATURE
Pressure	TV	2*	PRESSURE_PORT_A
Travel		3	TRAVEL
Drive Signal		4	DRIVE_SIGNAL
Pressure		5	PRESSURE_PORT_B
Travel Setpoint		6	TRAVEL_SETPOINT
Pressure		7	DIFFERENTIAL_PRESSURE
Pressure		8	SUPPLY_PRESSURE
Implied Valve Position	SV	9*	IMPLIED_VALVE_POSITION
Travel	QV	10*	PRIMARY_FEEDBACK
Milliamp Current		245	CURRENT

*Default Value indicated

Any of these choices [Dynamic Variable, Device Variable ID, or Device Variable Name(s)] can be substituted for the “#” sign in the Variable Identifier fields below.

Variable Identifier	Comments / Explanation
#	See any of the variable identifiers in the table immediately above.
#_CLASS	Always “0”.
#_CODE	The “Device Variable ID” number in the table immediately above.
#_HEALTHY	A “true” or “false” indication of the health of the sensor providing this value.
#_STATUS	
#_UNITS	Decimal “Variable Units code” number from the “Units Codes” table on page 7.

Device Status:

The eight standard status conditions (present in ANY HART field device) are all represented by a Boolean “true” or “false” state. These eight conditions, discussed on page 7, are:

- DEVICE_MALFUNCTION
- CONFIGURATION_CHANGED
- COLD_START
- MORE_STATUS_AVAILABLE
- LOOP_CURRENT_FIXED
- LOOP_CURRENT_SATURATED
- NONPRIMARY_VALUE_OUT_OF_LIMITS
- PRIMARY_VALUE_OUT_OF_LIMITS

Detailed Device Alerts:

The Alert Groupings are:

- ADDITIONAL_STATUS_0
- ADDITIONAL_STATUS_1
- ADDITIONAL_STATUS_2
- ADDITIONAL_STATUS_3
- ADDITIONAL_STATUS_4
- ADDITIONAL_STATUS_5
- ADDITIONAL_STATUS_6*
- ADDITIONAL_STATUS_7*
- ADDITIONAL_STATUS_8*

Each of these status bytes represent eight individual bits with values that range from “00” to “255”. To determine which of the eight bits are active requires converting a decimal value to its binary equivalent value. Refer to Command 48 on page 13 for details on the individual alert bits inside of each Additional Status Byte.

Note

Gateways with firmware version 4.4 define the alerts of DVC6200 SIS. There are slight differences between the names of the alerts as defined in the Gateway in the Command 48 tables, as detailed in the following tables.

ADDITIONAL_STATUS bytes 0 - 5 are supported by HART 5.

ADDITIONAL_STATUS bytes 0 - 8 are supported by HART 7.

ADDITIONAL_STATUS_0	According to Command 48:	As defined in the Gateway:
Bit 7	Flash Integrity Failure	FLASH_INTEGRITY_FAILURE
Bit 6	Minor Loop Sensor Alert	MINOR_LOOP_SENSOR_ALERT
Bit 5	Reference Voltage Failure	REFERENCE_VOLTAGE_FAILURE
Bit 4	Drive Current Failure	DRIVE_CURRENT_FAILURE
Bit 3	Critical NVM Failure	CRITICAL_NVM_ALERT
Bit 2	Temperature Sensor Failure	TEMPERATURE_SENSOR_ALERT
Bit 1	Pressure Sensor Failure	PRESSURE_SENSOR_ALERT
Bit 0	Travel Sensor Failure	TRAVEL_SENSOR_ALERT

ADDITIONAL_STATUS_1	According to Command 48:	As defined in the Gateway:
Bit 7	Alert Record Not Empty Alert	ALERT_RECORD_NOT_EMPTY_ALERT
Bit 6	Tripped by the LCP	TRIPPED_BY_THE_LCP
Bit 5	Calibration in Progress Alert	CALIBRATION_IN_PROGRESS_ALERT
Bit 4	Diagnostics in Progress Alert	DIAGNOSTICS_IN_PROGRESS_ALERT
Bit 3	Pressure Fallback Active Alert	PRESSURE_FALLBACK_ACTIVE_ALERT
Bit 2	SIS Program Flow Failure	SIS_PROGRAM_FLOW_FAILURE
Bit 1	NVM Protective Mode ⁽¹⁾	NVM_PROTECTIVE_MODE
Bit 0	Auto Cal in Progress Alert	AUTO_CAL_IN_PROGRESS_ALERT

1. Firmware Revision 3, 4, 5, & 6 only.

ADDITIONAL_STATUS_2	According to Command 48:	As defined in the Gateway:
Bit 7	SIS Hardware Failure	SIS_HARDWARE_FAILURE
Bit 6	Non-Critical NVM Alert	NON_CRITICAL_NVM_ALERT
Bit 5	Cycle Counter High Alert	CYCLE_COUNTER_HIGH_ALERT
Bit 4	Travel Accumulator High Alert	TRAVEL_ACCUMULATOR_HIGH_ALERT
Bit 3	Instrument Time is Approximate Alert	INSTRUMENT_TIME_IS_APPROXIMATE_ALERT
Bit 2	Alert Record Full Alert	ALERT_RECORD_FULL_ALERT
Bit 1	Offline / Failed Alert	OFFLINE_FAILED_ALERT
Bit 0	Reserved	

ADDITIONAL_STATUS_3	According to Command 48:	As defined in the Gateway:
Bit 7	Diagnostic Data Available Alert	DIAGNOSTIC_DATA_AVAILABLE_ALERT
Bit 6	PST Abnormal	VALVE_STUCK
Bit 5	Supply Pressure Low Alert	SUPPLY_PRESSURE_ALERT
Bit 4	End Point Pressure Deviation Alert	END_POINT_PRESSURE_DEVIATION_ALERT
Bit 3	SIS Locked in Safety Position	SIS_LOCKED_IN_SAFETY_POSITION
Bit 2	Supply Pressure High Alert ⁽¹⁾	
Bit 1	Integrator Saturated High Alert	INTEGRATOR_SATURATED_HIGH_ALERT
Bit 0	Integrator Saturated Low Alert	INTEGRATOR_SATURATED_LOW_ALERT

ADDITIONAL_STATUS_4	According to Command 48:	As defined in the Gateway:
Bit 7	Travel Alert Lo	TRAVEL_ALERT_LO
Bit 6	Travel Alert Lo Lo	TRAVEL_ALERT_LO_LO
Bit 5	Travel Alert Hi	TRAVEL_ALERT_HI
Bit 4	Travel Alert Hi Hi	TRAVEL_ALERT_HI_HI
Bit 3	Travel Deviation Alert	TRAVEL_DEVIATION_ALERT
Bit 2	Travel Limit / Cutoff Hi Alert	TRAVEL_LIMIT_CUTOFF_HI_ALERT
Bit 1	Travel Limit / Cutoff Lo Alert	TRAVEL_LIMIT_CUTOFF_LO_ALERT
Bit 0	Drive Signal Alert	DRIVE_SIGNAL_ALERT

ADDITIONAL_STATUS_5	According to Command 48:	As defined in the Gateway:
Bit 7	Reserved	
Bit 6	Reserved	
Bit 5	Reserved	
Bit 4	Reserved	
Bit 3	LCP Communications Failure	LCP_COMMUNICATIONS_FAILURE
Bit 2	Output Circuit Error	OUTPUT_CIRCUIT_COMMUNICATION_FAILURE
Bit 1	Output Pressure Limiting ⁽¹⁾	
Bit 0	Reserved	

1. Firmware Revision 7 or higher.

* ADDITIONAL_STATUS_6	According to Command 48:	As defined in the Gateway:
Bit 7	Reserved	
Bit 6	Reserved	
Bit 5	Function Check ⁽¹⁾	FUNCTION_CHECK
Bit 4	Out of Specification ⁽¹⁾	OUT_OF_SPECIFICATION
Bit 3	Failure ⁽¹⁾	FAILURE
Bit 2	Power Critically Low ⁽¹⁾	CRITICAL_POWER_FAILURE
Bit 1	Device Variable Alert	DEVICE_VARIABLE_ALERT
Bit 0	Maintenance Required	MAINTENANCE_REQUIRED

* ADDITIONAL_STATUS_7	According to Command 48:	As defined in the Gateway:
Bit 7	Reserved	
Bit 6	Reserved	
Bit 5	Reserved	
Bit 4	Reserved	
Bit 3	Reserved	
Bit 2	Reserved	
Bit 1	Reserved	
Bit 0	Reserved	

* ADDITIONAL_STATUS_8	According to Command 48:	As defined in the Gateway:
Bit 7	Configuration Locked	DEVICE_CONFIGURATION_LOCKED
Bit 6	Electronic Defect	ELECTRONIC_DEFECT
Bit 5	Environmental Limit	ENVIRONMENTAL_CONDITIONS_OUT_OF_RANGE
Bit 4	Voltage Error	POWER_SUPPLY_CONDITIONS_OUT_OF_RANGE
Bit 3	Reserved	WATCHDOG_RESET_EXECUTED
Bit 2	RAM Error	VOLITILE_MEMORY_DEFECT
Bit 1	NVM Error	NONVOLITILE_MEMORY_DEFECT
Bit 0	Variable Simulation Active	DEVICE_VARIABLE_SIMULATION_ACTIVE

* ADDITIONAL_STATUS bytes 6 - 8 are supported by HART 7 mode only.

1. Firmware Revision 7 or higher.



**Certificate of Registration
FieldComm Group Verified**

<u>Fisher Controls</u> Manufacturer	<u>DVC6200 SIS</u> Product Name
<u>0013</u> Manufacturer ID (Hex)	<u>130A</u> Expanded Device Type (Hex)
<u>7</u> HART Protocol Revision	<u>03</u> Device Revision (Hex)
<u>10</u> Hardware Revision (Hex)	<u>07</u> Software Revision (Hex)
<u>09/25/2017</u> Test Date	<u>FieldComm Group</u> Verification Method

The above product has successfully completed the validation process and meets the requirements to be "HART REGISTERED".
"HART REGISTERED" products conform to GB/T 29910.1-6-2013 and IEC 61158 standards.

Registration Number: L2-05-1000-693 Registration Issue Date: November 3, 2017 Approval: T. Y. Masters



HART® is a registered trademark of FieldComm Group

Neither Emerson, Emerson Automation Solutions, nor any of their affiliated entities assumes responsibility for the selection, use or maintenance of any product. Responsibility for proper selection, use, and maintenance of any product remains solely with the purchaser and end user.

Fisher, FIELDVUE, and Rosemount are marks owned by one of the companies in the Emerson Automation Solutions business unit of Emerson Electric Co. Emerson Automation Solutions, Emerson, and the Emerson logo are trademarks and service marks of Emerson Electric Co. HART and *WirelessHART* are registered trademarks of FieldComm Group. All other marks are the property of their respective owners.

The contents of this publication are presented for informational purposes only, and while every effort has been made to ensure their accuracy, they are not to be construed as warranties or guarantees, express or implied, regarding the products or services described herein or their use or applicability. All sales are governed by our terms and conditions, which are available upon request. We reserve the right to modify or improve the designs or specifications of such products at any time without notice.

Emerson Automation Solutions
Marshalltown, Iowa 50158 USA
Sorocaba, 18087 Brazil
Cernay, 68700 France
Dubai, United Arab Emirates
Singapore 128461 Singapore

www.Fisher.com

