



EMERSONTM

Original Instructions
1019568 - REV. 02



2000IW/IW+ Integrated Welder

Operating Manual

Branson Ultrasonics Corp.
120 Park Ridge Road
Brookfield, CT 06804
(203) 796-0400
<http://www.bransonultrasonics.com>

BRANSON



Manual Change Information

At Branson, we strive to maintain our position as the leader in ultrasonics plastics joining, cleaning and related technologies by continually improving our circuits and components in our equipment. These improvements are incorporated as soon as they are developed and thoroughly tested.

Information concerning any improvements will be added to the appropriate technical documentation at its next revision and printing. Therefore, when requesting service assistance for specific units, note the Revision information found on this document, and refer to the printing date which appears on this page.

Copyright and Trademark Notice

Copyright © 2021 Branson Ultrasonics Corp.

All rights reserved.

Contents of this publication may not be reproduced in any form without the written permission of Branson Ultrasonics Corp.

Trademarks and service marks mentioned herein are held by their respective owners.

Foreword

Congratulations on your choice of a Branson Ultrasonics Corporation system!

The Branson 2000-Series system is process equipment for the joining of plastic parts using ultrasonic energy. It is the newest generation of product using this sophisticated technology for a variety of customer applications. This Operating Manual is part of the documentation set for this system, and should be kept with the equipment.

Thank you for choosing Branson!

Introduction

This manual is arranged into several structured chapters which will help you find the information you may need to know to safely handle, install, set up, program, operate, and/or maintain this product. Please refer to the [Table Of Contents](#) and/or the [Index](#) of this manual to find the information you may be looking for. In the event you require additional assistance or information, see Section [1.4 How to Contact Branson](#) for information on how to contact the appropriate Branson representative.

Table Of Contents

Chapter 1: Safety and Support

1.1	Safety Requirements and Warnings	2
1.2	General Precautions	4
1.3	Warranty	6
1.4	How to Contact Branson	7
1.5	Returning Equipment for Repair	8
1.6	Obtaining Replacement Parts	11

Chapter 2: The 2000IW/IW+ Welder

2.1	Models Covered	14
2.2	Overview of these Models	15
2.3	Compatibility with Branson Products	18
2.4	Features	19
2.5	Front Panel Controls	20
2.6	Rear Panel	27
2.7	System Inputs/Outputs	29
2.8	Glossary	31

Chapter 3: Delivery and Handling

3.1	Shipping and Handling	34
3.2	Receiving	35
3.3	Unpacking	36
3.4	Returning Equipment	37

Chapter 4: Installation and Setup

4.1	About Installation	40
4.2	Handling and Unpacking	41
4.3	Take Inventory of Small Parts	44
4.4	Installation Requirements	45
4.5	Installation Steps	49
4.6	Accessory Input/Output Option	60
4.7	Guards and Safety Equipment	61
4.8	Assemble the Acoustic Stack	62
4.9	Installing the Ultrasonic Stack in the Integrated Welder	66
4.10	Adjusting Welder Height and Aligning the Horn	68
4.11	Adjusting the Mechanical Stop	69
4.12	Testing the Installation	73
4.13	Still Need Help? or Parts? Have Questions?	74

Chapter 5: Technical Specifications

5.1	Technical Specifications	76
-----	------------------------------------	----

Chapter 6: Operation

6.1	Weld Modes	82
6.2	Setting Weld Cycle Parameters	92
6.3	Controlling the Front Panel Display	95
6.4	Setup Procedure	96
6.5	Weld Cycle State Displays and Alarms	100
6.6	Resetting the System	107

6.7	Ultrasonic Test	108
6.8	Horn Down	109
6.9	Converter Cooling	110

Chapter 7: Maintenance

7.1	IW/IW+ Preventive Maintenance	112
7.2	Parts Lists	116
7.3	Circuits	117
7.4	Troubleshooting	118

List Of Figures

Chapter 1: Safety and Support

Figure 1.1	Safety Labels on the 2000IW/IW+ Integrated Welder	3
Figure 1.2	Safety Label on Left Door of the 2000IW/IW+ Integrated Welder	3

Chapter 2: The 2000IW/IW+ Welder

Figure 2.1	2000IW/IW+ Series Integrated Welder	15
Figure 2.2	Front Panel Controls, IW	20
Figure 2.3	Front Panel Displays, IW	22
Figure 2.4	Front Panel Displays, IW+	24
Figure 2.5	Rear Panel	27
Figure 2.6	Base, Showing START SWITCHES and Base Cable	29

Chapter 3: Delivery and Handling

Chapter 4: Installation and Setup

Figure 4.1	Unpacking the Stand (2000IW/IW+ on a Base); right-side view of Stand	41
Figure 4.2	Unpacking the Stand (2000IW/IW+ on a Hub); Hub shown separately	42
Figure 4.3	Ultrasonic Converter (J-Type for stand use) and Booster	43
Figure 4.4	2000IW/IW+ Integrated Welder Dimensional Drawing	46
Figure 4.5	Hooking Up the Air Line	48
Figure 4.6	Base Mounting Centers	50
Figure 4.7	Mounting Bolt Pattern for the Hub (for Stand on Hub)	51
Figure 4.8	Start Switch Connection Codes	52
Figure 4.9	Input/Output Signals, IW/IW+	54
Figure 4.10	Operating Cycle Timing Table, 2000IW	55
Figure 4.11	Operating Cycle Timing Table, 2000IW+	55
Figure 4.12	Moving Jumpers	56
Figure 4.13	International Harmonized Line Cord Color Code	56
Figure 4.14	Type 1 DIP Switch Marked "OPEN" on Top of Switch, Default Settings	57
Figure 4.15	Type 2 DIP Switch Marked "ON" on face of Switch, Default Settings	58
Figure 4.16	Accessory Input/Output Connector Pinout	60
Figure 4.17	Integrated Welder Emergency Stop Button	61
Figure 4.18	Assembling the 20kHz Acoustic Stack, Rectangular Horn	63
Figure 4.19	Assembling the 20kHz Acoustic Stack, Cylindrical Horn	64
Figure 4.20	Connecting Tip to Horn	65
Figure 4.21	Installing a 20kHz Stack in a Branson Welder	66
Figure 4.22	Mounting Circles on Base	67
Figure 4.23	Adjusting the Mechanical Stop	69
Figure 4.24	DIP Switch Location	70
Figure 4.25	Normal Front Panel Display after Power -Up, IW (left), IW+ (right)	73

Chapter 5: Technical Specifications

Figure 5.1	CJ 20 Converter	78
------------	-----------------	----

Chapter 6: Operation

Figure 6.1	Time Mode, IW+ only	86
Figure 6.2	Absolute Distance Mode, IW+ only	90
Figure 6.3	Setup and Operation in Time Mode	98
Figure 6.4	Setup and Operation in Collapse /Absolute Distance Modes	99

Chapter 7: Maintenance

Figure 7.1	Reconditioning Stack Surfaces	114
Figure 7.2	Disassembly of Air Filter Components	114
Figure 7.3	2000 IW/IW+ Interconnect Schematic.	117
Figure 7.4	Manual Adjustment Procedure Flowchart	119

List Of Tables

Chapter 1: Safety and Support

Table 1.1	Branson Contact	9
-----------	-----------------	---

Chapter 2: The 2000IW/IW+ Welder

Table 2.1	Front Panel Controls IW	20
Table 2.2	Front Panel Displays, IW	22
Table 2.3	Front Panel Displays, IW+	24
Table 2.4	Rear Panel	27

Chapter 3: Delivery and Handling

Table 3.1	Environmental Specifications	34
Table 3.2	Inspection upon delivery	35
Table 3.3	When unpacking the Integrated Welder, take the following steps	36

Chapter 4: Installation and Setup

Table 4.1	Small Parts Included (=x) with IW/IW+ integrated Welder	44
Table 4.2	List of Cables	44
Table 4.3	Environmental Specifications	47
Table 4.4	Input Power Requirements	47
Table 4.5	Options for Setting the Type 1 Switch Select Block	58
Table 4.6	Options for Setting the Type 2 Switch Select Block	59
Table 4.7	Assemble the Acoustic Stack	62
Table 4.8	Tools	63
Table 4.9	Stud Torque Values	64
Table 4.10	Tip to Horn Torque value	65

Chapter 5: Technical Specifications

Table 5.1	Environmental Specifications	76
Table 5.2	Electrical Requirements	76
Table 5.3	2000IW/IW+ Boosters	79
Table 5.4	Other items used with the 2000IW/IW+	79

Chapter 6: Operation

Table 6.1	Parameter Functions	83
Table 6.2	Limit Function	84
Table 6.3	Pretrigger Settings	84
Table 6.4	Time Mode Parameters, IW+ only	86
Table 6.5	Collapse Distance Mode Parameters, IW+ only	88
Table 6.6	Absolute Distance Mode Parameters, IW+ only	90
Table 6.7	Weld Parameter Values IW+ only	92
Table 6.8	Recalling Pre-defined Parameter Values	93
Table 6.9	2000IW State Displays	100
Table 6.10	2000IW+ State Displays	101
Table 6.11	Error Codes	103

Chapter 7: Maintenance

Table 7.1	Stack Reconditioning Procedure	113
Table 7.2	Replacement Parts	116



Chapter 1: Safety and Support



1.1	Safety Requirements and Warnings	2
1.2	General Precautions	4
1.3	Warranty.	6
1.4	How to Contact Branson.	7
1.5	Returning Equipment for Repair.	8
1.6	Obtaining Replacement Parts.	11

1.1 Safety Requirements and Warnings

This chapter contains an explanation of the different Safety Notice symbols and icons found both in this manual and on the product itself and provides additional safety information for ultrasonic welding. This chapter also describes how to contact Branson for assistance.

1.1.1 Symbols Found in this Manual

These symbols used throughout this manual warrant special attention:

WARNING	Indicates a possible danger
	If these risks are not avoided, death or severe injury might result.
CAUTION	Indicates a possible danger
	If these risks are not avoided, slight or minor injury might result.
NOTICE	Indicates a possible damaging situation
	If this situation is not avoided, the system or something in its vicinity might get damaged. Application types and other important or useful information are emphasized.

1.1.2 Symbols Found on the Product

Familiar graphic warning symbols are used to alert the user to items of concern or hazard. The following warning symbols appear on the 2000IW/ IW+ Integrated Welder.

Figure 1.1 Safety Labels on the 2000IW/IW+ Integrated Welder

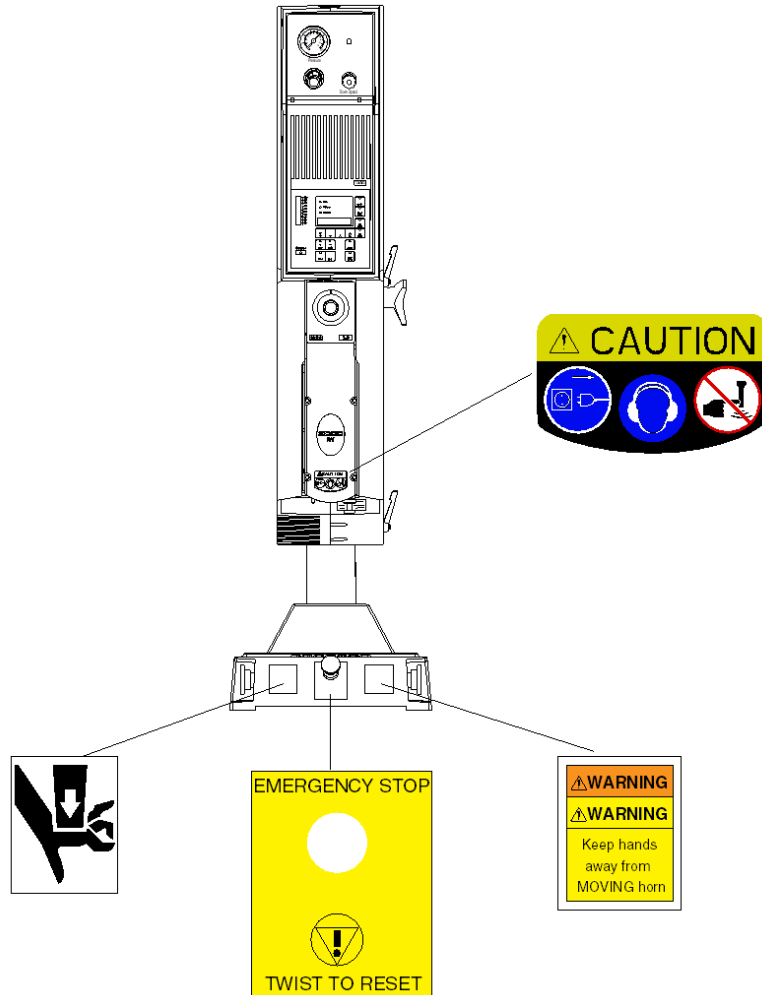
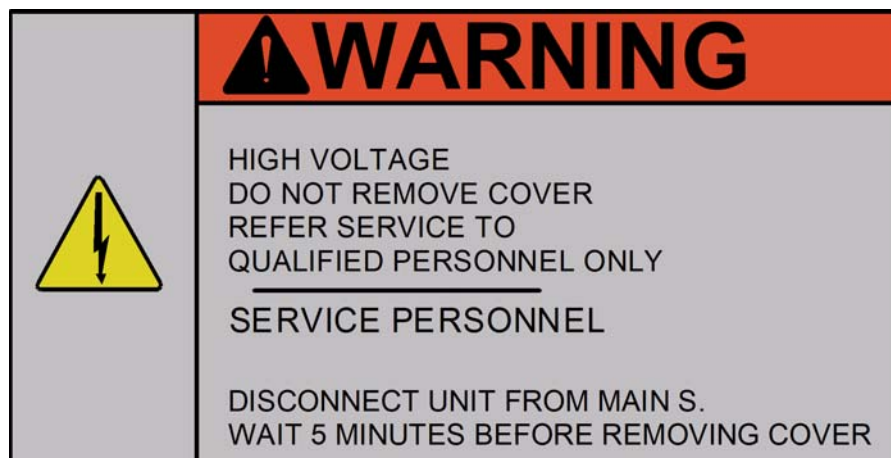



Figure 1.2 Safety Label on Left Door of the 2000IW/IW+ Integrated Welder



1.2 General Precautions

Take the following precautions before servicing the power supply, or setting DIP switches:

- Be sure the power switch is in the Off position before making any electrical connections
- To prevent the possibility of an electrical shock, always plug the power supply into a grounded power source
- Power supplies produce high voltage. Before working on the power supply module, do the following:
Turn off the power supply;
Unplug main power; and
Allow at least 2 minutes for capacitors to discharge
- High voltage is present in the power supply. Do not operate with the cover removed
- High line voltages exist in the ultrasonic power supply module. Common points are tied to circuit reference, not chassis ground. Therefore, use only non-grounded, battery-powered multimeters when testing these modules. Using other types of test equipment can present a shock hazard
- Be sure power is disconnected from the power supply before setting a DIP switch
- Keep hands from under the horn. Down force (pressure) and ultrasonic vibrations can cause injury
- Do not cycle the welding system if the converter is not installed
- When using larger horns, avoid situations where fingers could be pinched between the horn and the fixture
- Be aware that the Integrated Welder is “armed” if air pressure is indicated on the front panel air pressure gauge

CAUTION	Loud Noise Hazard
	<p>Sound level emissions of up to 102 dB have been measured using a standard test load. To prevent the possibility of hearing loss, use appropriate hearing protection.</p>

NOTICE	
	<p>Sound level and frequency of the noise emitted during the ultrasonic assembly process may depend upon a. type of application, b. size, shape and composition of the material being assembled, c. shape and material of the holding fixture, d. welder setup parameters and e. tool design. Some parts vibrate at an audible frequency during the process. Some or all of these factors may result in sound levels of up to 102 dB. In such cases operators may need to be provided with personal protective equipment. See 29 CFR (Code of Federal Regulations) 1910.95 Occupational Noise Exposure. For all other countries, follow your local regulations.</p>

1.2.1 Intended Use of the System

The 2000 Series Integrated Welder houses all the components of an ultrasonic welding system. These are designed for a wide variety of welding or processing applications.

1.2.2 Safety Measures and Guards

The 2000 Series Integrated Welder, contains software-controlled electronic safety devices intended to prevent the machine from operating in a fashion harmful to the user. Start Switch and Emergency Stop controls are designed to prevent undesirable startup.

1.2.3 Emissions

When being processed, certain plastic materials can emit toxic fumes, gases or other emissions that can be hazardous to the operator's health. Where such materials are processed, proper ventilation of the workstation is required. Check your materials suppliers for recommended protection when processing their materials.

CAUTION	General Warning
	<p>Processing of many materials, such as PVC, can be hazardous to an operator's health and could cause corrosion/damage to the equipment. Use proper ventilation and take protective measures.</p>

1.2.4 Setting up the Workplace

Measures for setting up a workplace for safe operation of the ultrasonic welder are outlined in [Chapter 1: Safety and Support](#).

1.2.5 Regulatory Compliance

The Branson 2000 Series Integrated Welder is designed for compliance with the following regulatory and agency standards:

- ANSI Z535.1 Safety Color Code
- ANSI Z535.3 Criteria for Safety Symbols
- ANSI Z535.4 Product Safety Signs and Labels
- BS EN ISO 12100-1, -2 Safety of Machinery - Basic concepts, general guidelines for design
- EN 55011 Limits and methods of measurement of radio disturbance of industrial, scientific and medical radio-frequency equipment
- EN 60204-1 Safety of Machinery - Electrical Equipment of machines
- EN 60529 Degrees of protection provided by enclosure
- EN 60664-1 Insulation coordination for equipment within low-voltage systems
- EN 61000-6-2 Electromagnetic Compatibility - Generic standards - Immunity for industrial environments
- EN 61310-2 Safety of Machinery - Indication, marking, actuation
- NFPA 70 National Electrical Code Article 670 Industrial Machinery
- NFPA 79 Electrical Standard for Industrial Machinery
- 29 CFR 1910.212 OSHA General Requirements for all machines
- 47 CFR Part 18 Federal Communication Commission

1.3 Warranty

For warranty information please reference the warranty section of Terms and Conditions found at: www.emerson.com/branson-terms-conditions.

1.4 How to Contact Branson

Branson is here to help you. We appreciate your business and are interested in helping you successfully use our products. To contact Branson for help, use the following telephone numbers, or contact the field office nearest you (business hours from 8 a.m. to 4 p.m. Central and Eastern Time Zones):

- **North American Headquarters (all Departments):** (203) 796-0400
- **Parts Store (direct number):** (877) 330-0406
- **Repair department:** (877)-330-0405
- **For emergency after-hours service (5 p.m.-8 a.m. EST):** (203) 796-0500 (US phone numbers only)

1.4.1 Before Calling Branson for Assistance

This manual provides information for troubleshooting and resolving problems that could occur with the equipment (see [Chapter 7: Maintenance](#)). If you still require assistance, Branson Product Support is here to help you. To help identify the problem, use the following questionnaire which lists the common questions you will be asked when you contact the Product Support department.

Before calling, determine the following information:

1. Your company name and location.
2. Your return telephone number.
3. Have your manual with you. If troubleshooting a problem, refer to [Chapter 7: Maintenance](#)
4. Know your equipment model and serial numbers (found on a gray data label on the units). Information about the Horn (part number, gain, etc.) or other tooling may be etched into the tooling. Software- or firmware-based systems may provide a BOS or software version number, which may be required.
5. What tooling (horn) and booster are being used?
6. What are the setup parameters and mode?
7. Is your equipment in an automated system? If so, what is supplying the "start" signal?
8. Describe the problem; provide as much detail as possible. For example, is the problem intermittent? How often does it occur? How long before it occurs if you are just powering up? If an error is occurring, which error (give error number or name)?
9. List the steps you have already taken.
10. What is your application, including the materials being processed?
11. Have a list of service or spare parts you have on hand (tips, horns, etc.)
12. Notes: _____

1.5 Returning Equipment for Repair

Before sending equipment for repair, provide as much information with the equipment to help determine the problem with the system. Use the following page to record necessary information.

NOTICE	
	To return equipment to Branson, you must first obtain an RGA number from a Branson representative, or the shipment may be delayed or refused.

If you are returning equipment to Branson for repair, you must first call the Repair department to obtain a **Returned Goods Authorization (RGA)** number. (If you request it, the repair department will fax a Returned Goods Authorization form to fill out and return with your equipment.)

Branson Repair Department, C/O Zuniga Logistics, LTD
12013 Sara Road, Killam Industrial Park
Laredo, Texas 78045 U.S.A.
direct telephone number: (877) 330-0405
fax number: (877) 330-0404

- Provide as much information as possible that will help identify the need for repair
- Carefully pack the equipment in original packing cartons
- Clearly label all shipping cartons with the RGA number on the outside of cartons as well as on your packing slip, along with the reason for return
- Return general repairs by any convenient method. Send priority repairs by air freight
- You must prepay the transportation charges FOB Laredo, Texas, U.S.A.

1.5.1 Get an RGA Number

RGA# _____

If you are returning equipment to Branson, please call the Brookfield Repair Department to obtain a Returned Goods Authorization (RGA) number. (At your request, the Repair Department will fax an RGA form to fill out and return with the equipment).

1.5.2 Record information about the Problem

Before sending equipment for repair, record the following information and send a copy of it with the equipment. This will greatly increase Branson's ability to address the problem.

1. Describe the problem; provide as much detail as possible.
For example, is the problem intermittent? How often does it occur? How long before it occurs after powering up?

2. Is your equipment in an automated system? NO / YES
3. If the problem is with an external signal, which signal? _____

4. If known, include plug/pin # (e.g., P29, pin #3) for that signal: _____
5. What are the Weld Parameters?

6. What is your application? (Type of weld, plastic material, etc.)

7. Name and phone number of the person most familiar with the problem:

8. Contact the Branson office prior to shipping the equipment.
9. For equipment not covered by warranty, to avoid delay, include a Purchase Order.

Send a copy of this page with the equipment being returned for repair.

1.5.3 Departments to Contact

Call your local Branson Representative, or contact the Branson facility by calling, and asking for the appropriate department, as indicated in [Table 1.1 Branson Contact](#) below.

Table 1.1 Branson Contact

What you need help with or information about	Whom to Call	At this Extension #
Information about new welding systems or components	Your local Branson Rep or Branson Customer Service	203-796-0400 Ext 384
Application and Setup questions on the welding system	Welding Applications Lab	203-796-0400 Ext 368
Application assistance on the Horns and Tooling	ATG Lab	203-796-0400 Ext 495
Technical questions about the welding system	Welding Product Support	203-796-0400 Ext 355, 551
Technical questions about Horns and Tooling	ATG Lab	203-796-0400 Ext 495
Ordering new parts	Parts Store	877-330-0406
RGA's, Request for Repair, Status of a Repair	Welding Repair Department	877-330-0405
System Automation/ hookup Information	Product Support	203-796-0400 Ext 355, 551

My Local Branson Representative's name is:

I can reach this representative at:

1.5.4 Pack and Ship the Equipment

1. Carefully pack the system in original packing material to avoid shipping damage. Plainly show the RGA number on the outside of cartons as well as inside the carton along with the reason for return. Make a list of all components packed in the box. KEEP YOUR MANUAL.
2. Return general repairs by any convenient method. Send priority repairs by air freight. Prepay the transportation charges FOB the repair site.

NOTICE	
	Items that are sent Freight Collect will be refused.

1.6 Obtaining Replacement Parts

You can reach Branson Parts Store at the following telephone numbers:

Branson Part Store

direct telephone number: 877-330-0406

fax number: 877-330-0404

Many parts can be shipped the same day if ordered before 2:30 p.m., Eastern time.

A parts list is found in [Chapter 7: Maintenance](#) of this manual, listing descriptions and EDP part numbers. If you need replacement parts, coordinate the following with your purchasing agent:

- Purchase order number
- 'Ship to' information
- 'Bill to' information
- Shipping instructions (air freight, truck, etc.)
- Any special instructions (for example, "Hold at the airport and call"). Be sure to give a name and phone number
- Contact name information

Chapter 2: The 2000IW/IW+ Welder

2.1	Models Covered	14
2.2	Overview of these Models	15
2.3	Compatibility with Branson Products	18
2.4	Features	19
2.5	Front Panel Controls	20
2.6	Rear Panel	27
2.7	System Inputs/Outputs	29
2.8	Glossary	31

2.1 Models Covered

This manual contains instructions for installing, setting up and operating a 2000IW and 2000IW+ Series Integrated Welders for 1100, 2200, and 3300 Watt output.

2.2 Overview of these Models

Figure 2.1 2000IW/IW+ Series Integrated Welder

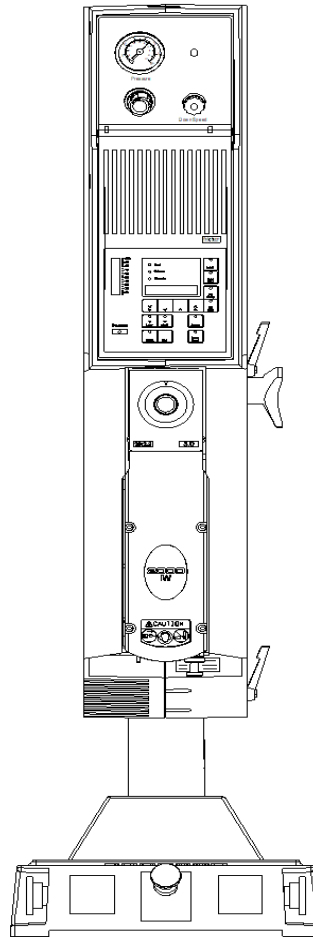

The 2000IW and IW+ Series Integrated Welders are ultrasonic plastic joining systems. They are used for welding plastic parts together by staking, insertion, swaging and degating.

These welders are self contained, free standing welding systems designed for upright vertical operation. Both the IW and IW+ Welders are available in 3 power levels, 1100 Watts, 2200 Watts, and 3300 Watts.

- For manual applications, welders can contain a base assembly with 2 Palm Buttons and an Emergency Stop knob
- For Automated applications, welders can contain a hub in place of the base assembly

A typical setup will be with a standard 40-inch column (4, 5 and 6 foot lengths are also available).

NOTICE	
	<p>It is advisable to have non standard length columns installed at the factory.</p>

An enclosure housing the carriage and slide system, the pneumatic system, the power supply and the Control Module. The Control Module consists of a Controller Board and a keyboard/display board.

A linear optical encoder provides detailed weld distance information, IW+ only.

2.2.1 Carriage and Slide System

The carriage is driven by a double-acting air cylinder, mounted on a linear, ball-bearing slide. The slide system is based on eight sets of preloaded, permanently lubricated bearings. These provide consistent, precise alignment of the horn, smooth linear motion, and long-term reliability.

2.2.2 Pneumatic System

The pneumatic system consists of a solenoid valve, and air cylinder, and a Pressure Regulator with an air-pressure gauge. The carriage's rate of descent is adjusted by the Down Speed control on the welder's front panel. The rate of ascent is fixed.

As the carriage travels up and down, cooling air from the exhaust air of the solenoid valve is directed through the carriage to the converter.

2.2.3 Power Supply Module

The Power Supply Module converts conventional 50/60 Hz line current ultrasonic energy at the resonant frequency of your Converter-Booster-Horn Stack. The Module Controller ensures maximum reliability by terminating ultrasonic energy if the welder is operated under adverse conditions. This protects both the power supply module and other welder components. The controller also tracks and compensates for changes in horn frequency, if necessary. These changes may occur due to increased temperatures, wear on the horn face, or material buildup on the horn.

2.2.4 System Control Module

The System Control Module consists of a Controller Board and a Keyboard/Display board. It controls the power supply module and the welder's pneumatic functions. The keyboard/display board allows the user to change weld parameters via the front panel displays and switches.

2.2.5 Linear Optical Encoder, a 2000IW+ only feature.

The Linear Optical Encoder is a sensing device that tracks carriage movement. The resolution of the encoder is 0.0001 in / 0.0025 mm.

NOTICE	
	The linear optical encoder reading will vary from the actual distance the carriage travels by no more than 1/4 in / 6 mm, due to the setting of the Upper Limit Switch (ULS). This distance is consistent from cycle to cycle.

Information from the linear optical encoder is used:

- To determine the relative position of the carriage at any point during the weld cycle
- To terminate the weld by absolute distance, the total distance the carriage travels from an upper limit position (ULS) to a preset lower limit position

- To terminate the weld by collapse distance, the total distance the carriage travels from the Dynamic Trigger Switch (TRS) to a preset lower limit position

2.2.6 Upper Limit Switch

The optical Upper Limit Switch (ULS) signals the control circuits in the Controller that the carriage has returned to the top of its stroke and the welder is ready to start another weld cycle.

The Controller uses this ULS signal to perform various control functions. For example:

- Indexing control, in automated systems, the Ready signal developed by the Controller after the ULS is activated can be used by external devices to prevent movement of the material handling equipment (indexing) when the horn is not fully retracted
- Electronic pretriggering, the Controller can use the ULS signal to activate ultrasonic energy before the horn contacts the workpiece. Pretriggering is used with large of difficult-to-start horns and in a variety of applications

2.2.7 User I/O Connector

External controls and devices, such as ALARMS, WELD ON and EXTERNAL RESET signals, are available through +24V DC interface on the back panel of the welder. In addition, a READY signal is available as both +24V DC and isolated contact closure. Using this interface, selected faults or weld errors sensed by the welder can be communicated outside the welder for monitoring cycles and sorting suspect workpieces.

2.2.8 Dynamic Triggering and Follow-Through

Many weld applications require that force be applied to the workpiece before ultrasonic energy is activated. To achieve this, the welder contains a Dynamic Triggering Mechanism, located between the air cylinder and the carriage. The Dynamic Triggering Mechanism initiates (triggers) ultrasonic energy after a preset force is applied to the workpiece. Dynamic follow-through maintains a consistent force on the workpiece during the weld collapse. The system helps provide uniform weld quality.

The calibrated TRIGGER PRESSURE control, located on the front panel, allows you to record and duplicate the dynamic triggering force.

2.3 Compatibility with Branson Products

The 2000IW/IW+ Series Integrated Welders are compatible for use with either a standard base or a hub for automation. The CJ20 converter is used for the 1100, 2200, and 3300 Watt units.

2.4 Features

The 2000IW/IW+ Series Integrated Welders can perform ultrasonic welding, inserting, staking, spot welding, swaging, degating, and continuous ultrasonic operations. It is designed for automated, semi-automated and/or manual production operations. The following list describes the control features of the welder.

Afterburst: This feature allows you to turn on the ultrasonics after the weld and hold steps to reliably release parts from the horn.

Alarms, Process: These are set values used for part quality monitoring.

Autotuning: Ensures that the welder is running at peak efficiency.

Cycle Aborts: These are user programmed conditions (ground detect, IW only) at which the cycle is terminated. These can be used as safety limits to save wear and tear on the system and your tooling.

Downspeed: Sets the advance speed of the horn towards the workpiece.

English (USCS)/Metric Units: This feature allows the welder to be programmed in the local units in use.

Horn Down Display, IW+ only: During Horn Down, the absolute Distance is displayed digitally so that you can determine correct values for settings.

Horn Down Mode: A manual procedure used to verify system setup and alignment.

Limits: A class of user-definable process alarms that alert you if a part falls into a range that you classified as reject parts.

Memory: When Memory is turned on, weld parameters at the end of the cycle will be entered.

Membrane Keyboard: For high reliability and immunity from factory dust and oils.

Pretrigger: This feature allows you to turn on the ultrasonics before contact with the part to increase performance.

Ramp Starting: The starting of the Power Supply Module and horn is done at the optimum rate to reduce electrical and mechanical stress on the system.

Seek: Ensures operation at resonance, minimizes tuning errors, and operates the stack at low amplitude (approximately 5%), then provides a means of sensing and storing the resonant operating frequency.

Start-up Diagnostics: At start-up, the controls test the major system components.

Timed Seek: When turned ON, will do a Seek once every minute to update horn resonant frequency to memory. This is especially useful when the welding process affects the actual temperature of the horn, causing a resonant frequency shift.

2.5 Front Panel Controls

Figure 2.2 Front Panel Controls, IW

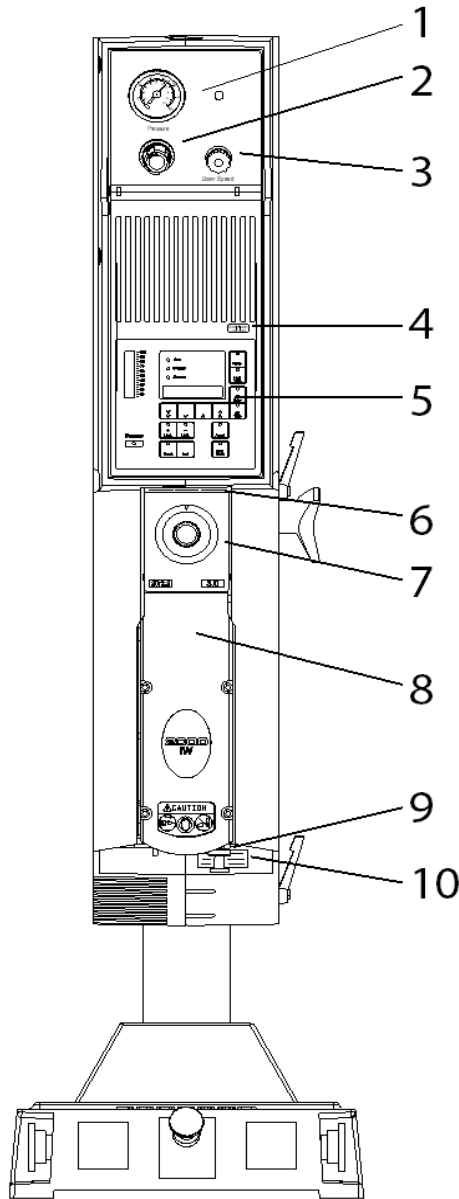

Table 2.1 Front Panel Controls IW

Item	Name	Function
1	Pressure Gauge	Indicates the amount of air pressure applied to a cylinder; dual-calibrated at 0-100 psig/0-700 kPa.
2	Pressure Regulator	Adjusts amount of air pressure applied to cylinder; range of 5-100 psig/35-700 kPa. Pull to set, push to lock.
3	Down Speed Control	Controls rate of carriage descent, multi-turn color coded, each turn calibrated at 0-9. Pull red locking to set; push locking ring to lock. Return rate is fixed.

Table 2.1 Front Panel Controls IW

Item	Name	Function
4	Autotune Label	Refer to Section 7.4.1 Manual Tuning
5	Front Panel Displays	Refer to next Section
6	Stroke Indicator	Provides a quick method of determining relative carriage travel during a weld cycle; indicates 0-4 in (0-100 mm).
7	Trigger Pressure Control	Selects dynamic triggering pressure; calibrated 1-24 in half-steps/48 detents corresponding to a force range of 15-200 lbs/67-890 N.
8	Carriage Door	Provides access to the converter-booster-horn stack; secured by 4 captive hex screws.
9	Mechanical Stop Locking Nut	Locks the mechanical stop to desired depth.
10	Mechanical Stop	Limits the distance the carriage travels to prevent horn from contacting the fixture or nest when no workpiece is in place; adjustment is approximately 0.04 in/1 mm per rotation.

This multi-turn control is calibrated in color rings, visible in slots.

Figure 2.3 Front Panel Displays, IW

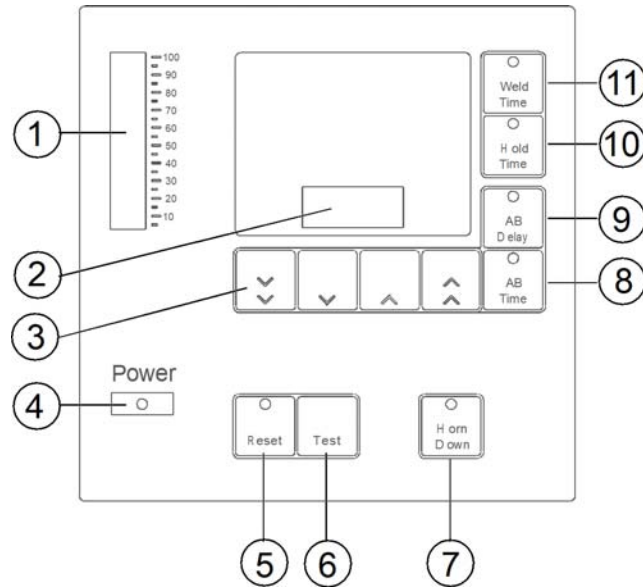

Table 2.2 Front Panel Displays, IW

Item	Name	Function
1	Power Bargraph	This 20 segment bargraph displays the power level during the Test mode; or the power applied to the workpiece during a weld cycle. While in READY state, the graph display the peak power of the last weld cycle. These readings can be expanded by altering DIP switch settings. When using the 2x scale, the uppermost segment will blink. Refer to section 4.11.1 Setting DIP Switches for further information on DIP settings.
2	Numeric Display	During a weld cycle, indicates the correct weld state code enabled, or the currently selected parameter's value. At the end of the weld cycle, it displays alarms.
3	Up/Down Switches	Once you have selected weld parameters to change, these four switches increase or decrease your selected parameters displayed in the NUMERIC DISPLAY. From left to right, these switches are referred to as the FAST DOWN switch, the SLOW DOWN switch, the SLOW UP switch, and the FAST UP switch. Pressing these switches will have no effect until you have selected parameters to change. These switches will be disabled when Display Lock is active.
4	Power Indicator	Indicates that power to the welder is on.
5	Reset Switch	Resets any resettable or latchable alarm condition (indicated by the switch LED blinking). Holding RESET prevents a weld cycle from starting. Releasing RESET returns the welder to the READY state, if there are no non-resettable errors.

Table 2.2 Front Panel Displays, IW

Item	Name	Function
6	Test Switch	Activates ultrasonic power and places the ultrasonic power supply module into Test (autotune) mode for approximately 6 seconds). While this switch is pressed, power displays on both the NUMERIC DISPLAY and the POWER BARGRAPH. When you release TEST, the welder returns to the READY state. You can select the scale factor for Test mode by setting the Test Scale Multiplier DIP Switch to 1x or 2x. Refer to Section 4.11.1 Setting DIP Switches for further information about DIP settings.
7	Horn Down Switch	Selects the HORN DOWN mode. When pressed, the switch LED will light. Pressing the START SWITCHES while in the Horn Down mode will bring the carriage down without triggering ultrasonics. Pressing the switch again will de-select HORN DOWN mode.
8	AB Time Switch	Selects the afterburst TIME parameter for modification when display lock is inactive; displays the AB TIME parameter in the NUMERIC DISPLAY, and lights the AB TIME switch LED.
9	AB Delay Switch	Selects the Afterburst DELAY parameter for modification when display lock is inactive; displays the AB DELAY parameter in the NUMERIC DISPLAY, and lights the AB DELAY switch LED.
10	Hold Time Switch	Selects the Hold Time parameter for modification when display lock is inactive; displays the Hold parameter in the NUMERIC DISPLAY, and lights the Hold Time switch LED.
11	Weld Time Switch	Selects the Weld Time parameter for modification when display lock is inactive; displays the Weld parameter in the NUMERIC DISPLAY; and lights the Hold Time switch LED.

Figure 2.4 Front Panel Displays, IW+

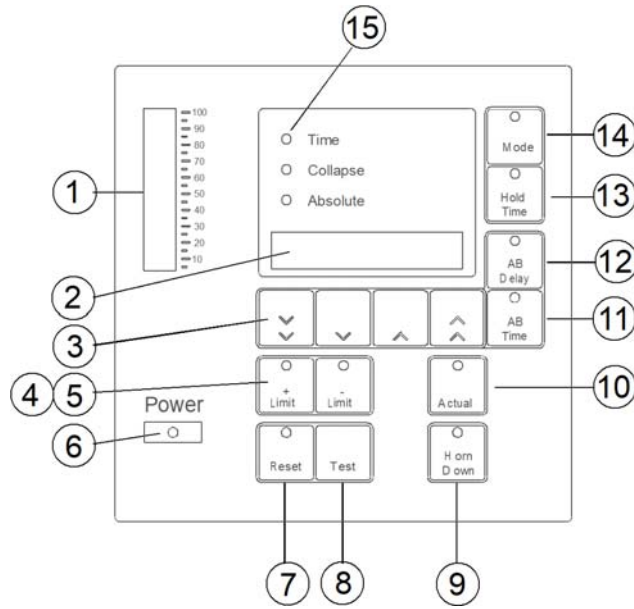

Table 2.3 Front Panel Displays, IW+

Item	Name	Function
1	Power Bargraph	This 20 segment bargraph displays the power level during the Test mode; or the power applied to the workpiece during a weld cycle. While in the READY state, the graph displays the peak power of the last weld cycle. These readings can be expanded by altering DIP switch settings. When using the 2x scale, the uppermost segment will blink. Refer to section 4.11.1 Setting DIP Switches for further information about DIP settings.
2	Numeric Display	During a weld cycle, indicates the current weld state code, if enabled, or the currently selected parameter's value. At the end of the weld cycle, it displays alarms.
3	Up/Down Switches	Once you have selected weld parameters to change, these four switches increase or decrease your selected parameters displayed in the NUMERIC DISPLAY. From left to right, these switches are referred to as the FAST DOWN switch, the SLOW DOWN SWITCH, the SLOW UP switch, and the FAST UP switch. Pressing these switches will have no effect until you have selected parameters to change. These switches will be disabled when Display Lock is active.
4	+ Limit Switch, a 2000IW+ only feature	Selects the maximum value for the mode you are in. When pressed, the switch LED will light. This switch is only active after you have pressed MODE.
5	- Limit Switch, a 2000IW+ only feature	Selects the minimum value for the mode you are in. When pressed, the switch LED will light. This switch is only active after you have pressed MODE.
6	Power Indicator	Indicates that power to welder is ON.

Table 2.3 Front Panel Displays, IW+

Item	Name	Function
7	Reset Switch	Resets any resettable or latching alarm condition (indicated by the switch LED blinking). Holding RESET prevents a weld cycle from starting. Releasing RESET returns the welder to the ready state, if there are no non-resettable errors.
8	Test Switch	Activates ultrasonic power and places the ultrasonic power supply module into Test (autotune) mode for approximately 6 seconds. While this switch is pressed, power displays on both the NUMERIC DISPLAY and the POWER BARGRAPH. When you release TEST, the welder returns to the READY state. You can select the scale factor for Test mode by setting the Test Scale Multiplier DIP switch to 1x or 2x. Refer to section 4.11.1 Setting DIP Switches for further information about DIP settings.
9	Horn Down Switch	Selects the Horn Down mode. When pressed, the switch LED will light and the NUMERIC DISPLAY will show the current linear encoder reading. If you have selected USCS units, 0.0000" (representing inches) will appear on the NUMERIC DISPLAY; if you have selected SI units, 0.0000 (representing millimeters) will appear. Pressing the START SWITCHES while in the Horn Down mode will bring the carriage down without triggering ultrasonics. Pressing the switch again will de-select HORN DOWN mode.
10	Actual Switch, a 2000IW+ only feature	Selects for display the actual value for the previous weld. Each succeeding press will display the actual value of each of the three modes in turn, displaying the actual time or actual distance and lighting the relevant MODE INDICATOR LED. The fourth press will return the welder to the READY state. Although the MODE INDICATOR LEDs change with each press of ACTUAL, the welder mode does not change. Pressing MODE will display the current mode again.
11	AB Time Switch	Selects the Afterburst TIME parameter for modification when display lock is inactive; displays the AB TIME parameter in the NUMERIC DISPLAY, and lights the AB TIME switch LED.
12	AB Delay Switch	Selects the Afterburst DELAY parameter for modification when display lock is inactive; displays the AB DELAY parameter in the NUMERIC DISPLAY, and lights the AB DELAY switch LED.
13	Hold Time Switch	Selects the Hold Time parameter for modification when display lock is inactive; displays the Hold parameter in the NUMERIC DISPLAY, and lights the Hold Time switch LED.

Table 2.3 Front Panel Displays, IW+

Item	Name	Function
14	Mode Switch, a 2000IW+ only feature	Selects between Time and Collapse and Absolute Distance modes; changes the display for the selected mode, and allows for changes in mode or mode parameters when Display Lock is inactive.

NOTICE

In Collapse or Absolute Distance Modes the weld time parameter acts as an overriding condition. Ensure Time is setup to allow for the collapse or absolute distances to be attained during a weld.

15	Mode Indicator LEDS, a 2000IW+ only feature	Light once you have selected the mode you wish to alter; indicate the mode selected.
----	---	--

2.6 Rear Panel

The grayed out portion shows placement of the optional Accessory Input/Output (1), and Ground Detect inputs (2, 3) and the position of the mounting plate supplied in their respective kits (see below).

Figure 2.5 Rear Panel

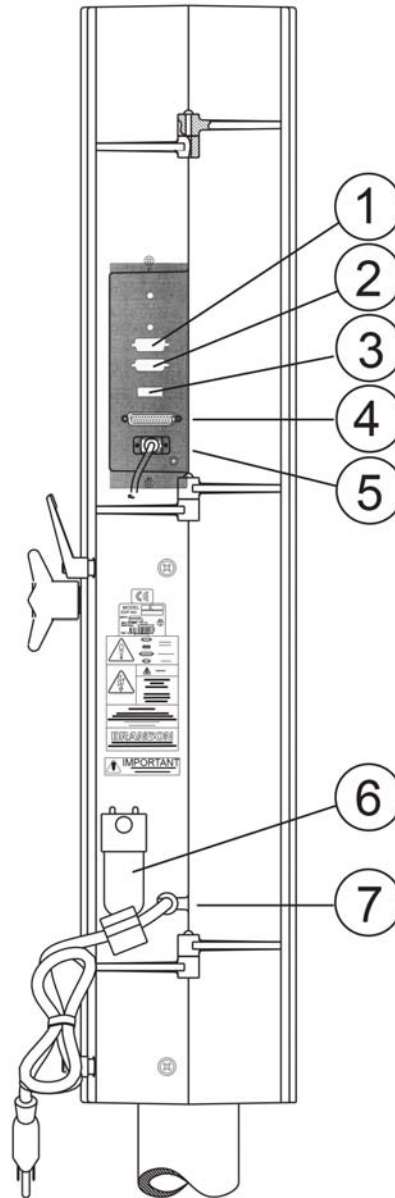

Table 2.4 Rear Panel

Item	Name	Function
1	Accessory Input/Output	An advanced feature that allows connection of Power Out, Memory, Seek, Frequency, Frequency Offset, Power Supply Module Status Outputs, Amplitude Output and Amplitude Control Input. Requires Accessory Input/Output kit 101-063-721. 15 pin male connector.

Table 2.4 Rear Panel

Item	Name	Function
2	Ground Detect, 15 pin female connector	An optional 2000IW only feature, allows ultrasonic energy to be turned off when the horn comes in contact with your electrically isolated fixture or anvil. Requires Ground Detect Kit, 101-063-343.
3	Ground Detect, 3 pin connector	
4	User I/O, Alarm Connector	25 pin D-shell connector provides a +24V DC interface for external controls and devices. ALARMS, WELD ON and EXTERNAL RESET signals are available. In addition, a READY signal is available as both +24V DC and isolated contact closure. Using this connector, selected faults or weld errors sensed by the welder can be communicated outside the welder for monitoring cycles and sorting suspect workpieces. Connector 4 is a 25 pin female.
5	Start Connector	Connects the welder to its base or to customer supplied start signals. Connector 5 is a 9 pin male.
6	Air Filter	Filters contaminated from the air entering the welder.
7	Line Cord	Connects the welder to your power source.

2.7 System Inputs/Outputs

The inputs provided to the welder are used to control the weld cycle and monitor the 2000IW/IW+ hardware.

2.7.1 START SWITCHES/START Signal - START Connector

These inputs are used to start the weld cycle. To start a weld cycle, both START SWITCH inputs must become active within 100 (IW) or 200 (IW+) ms of each other, and remain active until TRS activates, or an error will be generated and no weld will be performed

Errors will also be generated if the START SWITCHES do not remain active until the TRS input becomes active (for maintained software), or are not inactive within 4 seconds after the solenoid valve drive circuits have been disabled

Figure 2.6 Base, Showing START SWITCHES and Base Cable

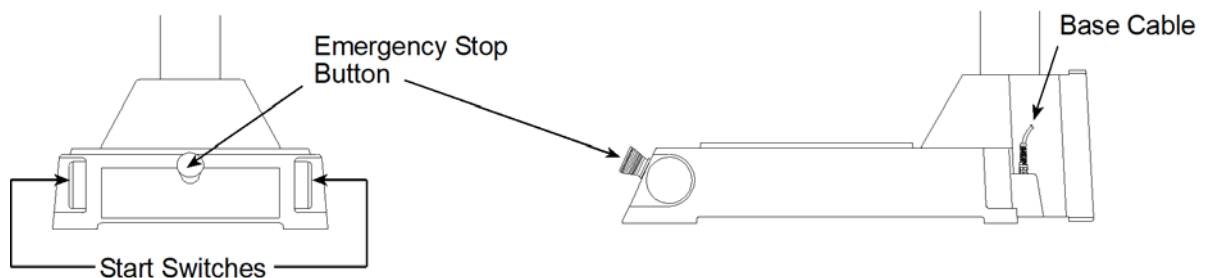

2.7.2 EXTERNAL RESET - ALARM (User I/O) Connector

This input, when activated, will simulate pressing RESET (refer to [Figure 2.3 Front Panel Displays, IW](#), item 5, and [Figure 2.4 Front Panel Displays, IW+](#), item 7). You cannot start a weld cycle if the EXTERNAL RESET line is active.

2.7.3 READY Signal - ALARM Connector

The welder uses the Upper Limit Switch (ULS) input to determine when the carriage has started to descend and when it has reached its "home" position on its return at the end of the weld cycle.

The Controller evaluates other system conditions as well before generating the READY signal. It evaluates if any alarm conditions exist. Monitoring this signal indicates that the welder is at rest and it is ready to cycle (for example not in TEST, HORN DOWN, latched alarm condition or system fault).

2.7.4 GENERAL ALARM - Alarm Connector

GENERAL ALARM is a signal which indicates that an alarm has been sensed. Resetting alarms and resolving system faults clears this alarm signal. Refer to [6.5 Weld Cycle State Displays and Alarms](#) for further information.

2.7.5 WELD ON Signal - Alarm Connector

The WELD ON signal indicates you are in the Weld Time portion of the cycle and that TRS is active. This signal indicates when a start signal can be released.

In any of the following situations, an error will be generated:

- The input becomes inactive while the welder is in the READY state
- The input does not become inactive within 4 seconds after the solenoid valves are activated
- The input becomes active before weld timing begins during a weld cycle
- The input does not become active within 4 seconds after the solenoid valves are deactivated

2.8 Glossary

The following terminology may be encountered when using or operating a 2000-series ultrasonic welding system. Some of these terms may not be available in all configurations:

AB Amplitude: The amplitude at the horn face during the afterburst step.

AB Delay: Time delay between the end of the hold and the start of afterburst.

AB Time: The time duration of the afterburst.

Absolute Distance: The distance the horn has traveled from home.

Absolute Mode: A mode of operation in which the weld is terminated when a user-specified distance from the home position has been reached.

Absolute Position: The position of the Actuator from the home position.

Accept-as-is: A disposition permitted for a nonconforming item when it can be established that the item is satisfactory for its intended use without violating safety or functional requirements.

Actual: A reported value that occurred during the weld cycle. The converse is the set parameter that was requested during the setup.

Actuator: The section of the Integrated Welder that houses the converter, booster, and horn assembly in a rigid mounting allowing it to move up and down either mechanically or pneumatically to apply a predetermined pressure on the workpiece.

Afterburst: Ultrasonic energy applied after the hold step. Used to break away sticking parts from the tooling.

Alarm Beeper: An audible signal that sounds when a general alarm has occurred.

Amplitude: The peak-to-peak movement at the horn face. Always expressed as a percentage of the maximum.

Amp Control: The ability to set amplitude digitally or by an external control.

Automatic: A pretrigger condition indicating that pretrigger engages when the actuator leaves the upper limit switch.

Beep: An audible signal produced by the Branson control board. Used to alert the operator to an unexpected condition or that trigger has been reached.

Booster: A one-half wavelength long resonant metal section mounted between the converter and horn, usually having a change in cross-sectional area between the input and output surfaces. Mechanically alters the amplitude of vibration at the driving surface of the converter.

Clamping Force: The pressure exerted by the horn on the workpiece.

Cold Start: A user operation to establish a setup to a new, initial minimum set of weld parameters. Refer to [6.6 Resetting the System](#). **Note:** Use carefully.

Collapse Distance: The vertical distance your part will be collapsed before termination of ultrasonics.

Collapse Mode: A mode of operation in which the weld is terminated when the part has been collapsed by a user-specified distance.

Custom Logic: Allows the operator to choose either High (24V) or Low (0V) logic for switches to be used in interfacing the welder to an automated system.

Cycle Aborts: There are no cycle aborts except Ground Detect, which is available in IW only.

Downspeed: The rate of speed of the actuator from the home position to the part.

General Alarm: An alarm that occurs due to a system fault and/or tripping a limit.

Ground Det. Cutoff: Immediately terminates the weld process, including the hold step, when a ground detect has occurred.

Ground Detect Mode: In this mode of operation, ultrasonics are terminated after detection of a ground condition between the horn and fixture or anvil.

Horn Down: A mode in which ultrasonics are locked out and the user can advance the Actuator for setup and alignment.

Linear Encoder: Provides carriage distance measurement during the welder cycle. IW+ only.

Pretrigger: The setting that causes ultrasonics to start before contact with the part.

Ready Position: State in which the welder is retracted and ready to receive the start signal.

Limits: User-definable limits at which the violating cycle is identified as having produced a bad part.

Required: State used with limits indicating that a reset will be required when the limit is exceeded. The reset is accomplished by using the reset key on the front of the Integrated Welder, or by external reset at the User I/O.

Reset Required: State used with alarms indicating that a reset will be required before a cycle can be run. The reset is accomplished by using the reset key on the front of the Integrated Welder, or by external reset at the User I/O.

Scrub Time: The amount of time after detection of a ground condition (option IW only) to the termination of ultrasonics.

Seek: A setting where ultrasonics are on at 5% amplitude for the purpose of finding the resonant frequency of the stack.

Stack: Converter, Booster, and Horn.

Test Scale: The magnification of the power bar scale on the front panel while the Test key is pushed.

Time Mode: Terminates the ultrasonics at a user-specified time. **Note:** In Collapse or Absolute Distance Modes the weld time parameter acts as an overriding condition. Ensure Time is setup to allow for the collapse or absolute distances to be attained during a weld.

Timeout: A time at which the ultrasonic energy terminates if the main control parameter has not been reached.

Trigger Beeper: An audible signal sounded when the trigger is made.

Upper limit switch (uls): A switch when activated indicates the actuator is in the home position.

User-defined limits for process resultants, where – is the user-defined lower limit, and + is the user defined upper limit:

–/+ Time: The weld time reached during the weld.

–/+ Abs D: The absolute distance from the Home position reached during the weld.

–/+ Col D: The collapse distance reached during the weld.

Weld Time: The time for which ultrasonics are on.

Chapter 3: Delivery and Handling

3.1	Shipping and Handling	34
3.2	Receiving	35
3.3	Unpacking	36
3.4	Returning Equipment	37

3.1 Shipping and Handling

CAUTION	General Warning
	<p>The Integrated Welder internal components are sensitive to static discharge. Many components can be harmed if the unit is dropped, shipped under improper conditions or otherwise mishandled.</p>

3.1.1 Environmental Specifications

The Integrated Welder is an electronic unit that converts line voltage to ultrasonic energy and controls user input for regulating the weld process. Its internal components are sensitive to static discharge, and many of its components can be harmed if the unit is dropped, shipped under improper conditions, or otherwise mishandled.

The following environmental guidelines should be respected in the shipping of the Integrated Welder.

Table 3.1 Environmental Specifications

Environment	Range
Storage / Shipping Temperature	-25° C to +55° C (-13° F to +131° F); up to +70° C (+158° F) for 24 hours
Shock / Vibration (transit)	40 g shock / 0.5 g and (3-100 Hz) vibration per ASTM 3332-88 and 3580-90
Humidity	30% to 95%, non-condensing

3.2 Receiving

The Integrated Welder is a sensitive electronic device. Many of its components can be harmed if the unit is dropped or otherwise mishandled.

CAUTION	Heavy Object
	<p>The Integrated Welder is heavy. Handling, unpacking, and installation may require assistance or the use of a lifting device.</p>

Scope of Delivery

Branson Integrated Welder units are carefully checked and packed before dispatch. It is recommended, however, that you follow the inspection procedure below after delivery.

3.2.1 To inspect the Integrated Welder when it is delivered, take the following steps

Table 3.2 Inspection upon delivery

Step	Action
1	Verify that all parts are complete according to the packing slip.
2	Check the packing and the unit for damage (visual inspection).
3	Report any damage claims to your carrier immediately.
4	Determine if any component has become loose during shipping and, if necessary, tighten screws.

NOTICE	
	<p>If the goods delivered have been damaged during shipping, please contact the forwarding agent immediately. Retain packing material (for possible inspection or for sending back the unit).</p>

CAUTION	Heavy Object
	<p>The Integrated Welder is heavy. Handling, unpacking, and installation may require the assistance of a colleague or the use of lifting platforms or hoists.</p>

3.3 Unpacking

The Integrated Welder is fully assembled. It is shipped in a sturdy cardboard box. Some additional items are shipped in the box with the Integrated Welder.

Table 3.3 When unpacking the Integrated Welder, take the following steps

Step	Action
1	Unpack the Integrated Welder as soon as it arrives. Save the packing material.
2	Inspect the controls, indicators, and surface for signs of damage.
3	Remove the cover of the Integrated Welder (Table 7.2 Replacement Parts) to check if any components became loose during shipping.

NOTICE

If damage has occurred, notify the shipping company immediately. Retain packing materials for inspection.

3.4 Returning Equipment

If you are returning equipment to Branson Ultrasonic Corporation, please call your Customer Service Representative to receive approval to return goods to Brookfield.

If you are returning equipment for repair refer to [Chapter 1: Safety and Support](#), Section [1.5 Returning Equipment for Repair](#), of this manual, for appropriate procedure.



Chapter 4: Installation and Setup

4.1	About Installation.	40
4.2	Handling and Unpacking.	41
4.3	Take Inventory of Small Parts	44
4.4	Installation Requirements	45
4.5	Installation Steps	49
4.6	Accessory Input/Output Option	60
4.7	Guards and Safety Equipment	61
4.8	Assemble the Acoustic Stack	62
4.9	Installing the Ultrasonic Stack in the Integrated Welder	66
4.10	Adjusting Welder Height and Aligning the Horn	68
4.11	Adjusting the Mechanical Stop	69
4.12	Testing the Installation	73
4.13	Still Need Help? or Parts? Have Questions?	74

4.1 About Installation

This Chapter is intended to help the installer with the basic installation and setup of your new 2000 Series Integrated Welder. This chapter will bring the reader to the point at which the system is functionally “ready to weld”.

CAUTION	Heavy Object
	The Integrated Welder weighs 145 pounds. Handling, unpacking, and installation can require help or the use of lifting platforms or hoists.

International safety labels are found on the 2000IW/IW+ Integrated Welder. Those that are of importance during installation of the system are identified in the figures in this and other chapters of the manuals.

4.2 Handling and Unpacking

If there are any visible signs of damage to the shipping containers or the product, or you later discover hidden damage, NOTIFY YOUR CARRIER IMMEDIATELY. Save the packing material.

1. Unpack the 2000-series components as soon as they arrive. Refer to the following procedures
2. Verify you have all of the equipment ordered. Some components are packed inside other boxes
3. Inspect the controls, indicators, and surfaces for signs of damage
4. Save all packing material, including the pallets and wood spacer blocks

4.2.1 Unpack the Integrated Welder

The Integrated Welder is heavy (145 lbs.) and packed in a protective shipping container. The actuator toolkit is packed with the welder. A booster, converter and other components may be packed inside the shipping container (depending on the equipment ordered).

- Integrated Welders are shipped on a wooden pallet with a cardboard box cover over protective foam shells for support
- Heed the "This End Up" arrows and the "Open Top First" instructions. The packaging is designed to be removed from the assemblies from an upright orientation only

Figure 4.1 Unpacking the Stand (2000IW/IW+ on a Base); right-side view of Stand

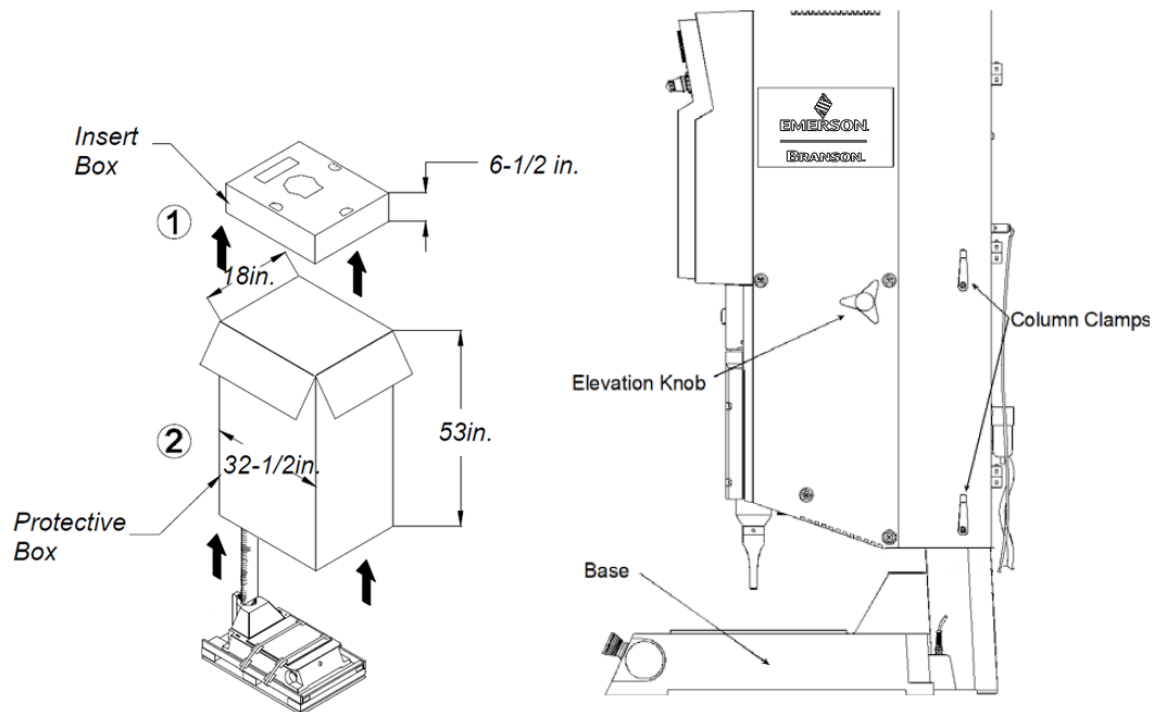

1. Move the shipping container close to the intended installation location, leave it on the floor.
2. Remove plastic bag, tape, staples, and strip from the top of the box.
3. Open the top of the box. Remove the insert from the top of the protective box.
4. Remove the staples at the bottom of the protective box. Lift the protective box off the pallet.

CAUTION	General Warning
	<p>The column and column support are under spring tension from the counterbalance spring. Do NOT attempt to disassemble the column from the stand, but always keep the column support clamped together. When making height adjustments, carefully and slowly release the clamps to control the motion, and hold the stand to prevent sudden movements or injury.</p>

5. Cut the two packing straps around the base and pallet. Pry off the two wooden shipping blocks (to the rear of the base) which prevent the base from sliding on the pallet
6. The stand can now be moved into its desired location by sliding it off the pallet.
7. Remove the block of wood between the base and the column support by carefully loosening the two column clamps (allowing the actuator to rise slightly, but not allow sudden movements) and then cutting the shipping tape on the block of wood. **RETIGHTEN THE COLUMN CLAMPS**
8. Unpack the toolkit, and other parts (converter, booster, cables, manuals, etc.) that may have shipped with the stand. Save the packing material
9. Go to [4.3 Take Inventory of Small Parts](#)

4.2.2 Stand (2000IW/IW+ on a Hub)

Figure 4.2 Unpacking the Stand (2000IW/IW+ on a Hub); Hub shown separately

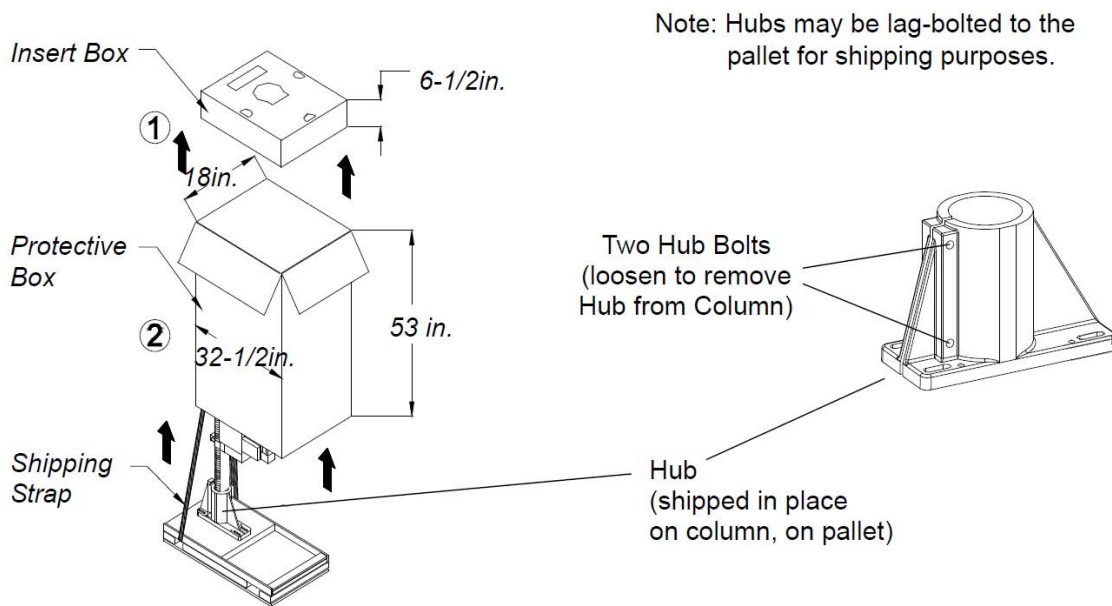

CAUTION	General Warning
	<p>Heed the "This End Up" arrows and the "Open Top First" instructions. The packaging is designed to be removed from the assemblies from an upright orientation only.</p>

1. Move the shipping container close to the intended installation location, leave it on the floor.
2. Remove plastic bag, tape, staples, and strip from the top of the box.
3. Cut the two vertical packing straps, and open the top of the box. Remove the insert from the top of the box. Set the insert box aside.
4. Remove the staples at the bottom of the protective box. Lift the protective box off the pallet. Flatten the box and lay it next to the pallet (you will lay the stand on it soon).

CAUTION	General Warning
	<p>The unit may tend to tip over. Stabilize the stand with the help of an assistant.</p>

5. Cut the packing strap securing the column support to the pallet.

CAUTION	General Warning
	<p>The column and column support are under spring tension from the counterbalance spring. Do NOT attempt to disassemble the column from the stand, but always keep the column support clamped together. When making height adjustments, carefully and slowly release the clamps to control the motion, and hold the stand to prevent sudden movements or injury.</p>

6. Remove the block(s) of wood between the base and the support by slowly loosening the two column clamps (allowing the stand to rise slightly) and then cutting the shipping tape on the block of wood. **RETIGHTEN THE COLUMN CLAMPS.**
7. Loosen the two hub bolts (for column clamping) on the hub.
8. Lift the actuator and column from the pallet. Carefully lay the stand on its right side (NOT ON THE SIDE WITH THE LINEAR ENCODER).
9. Remove the hub from the pallet and set it aside. Some hubs are bolted to the pallet from the top.
10. Unpack the converter, booster, cables, manuals, and toolkit that may be in the insert box. Save the packing material, including the blocks of wood.
11. Go to Section [4.3 Take Inventory of Small Parts](#)

NOTICE	
	<p>The packaging may also include the converter and/or booster, if ordered.</p>

Figure 4.3 Ultrasonic Converter (J-Type for stand use) and Booster



4.3 Take Inventory of Small Parts

Table 4.1 Small Parts Included (=x) with IW/IW+ integrated Welder

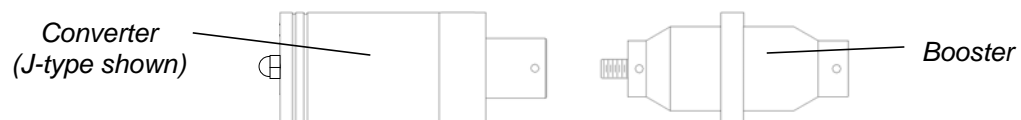
Part or Kit	20kHz	Stand (Base)	Stand (Hub)
T-Handle Wrench		x	x
Mylar Washer Kit	x		
20kHz Spanners (2)	x		
Fixture Bolts and Washer		x	
M8 Allen Wrench		x	x

4.3.1 Cables

For status/alarm interfacing with the 2000IW+ CE Welder, you may also need a J971 alarm cable. See [Table 4.2 List of Cables](#) for available lengths.

Table 4.2 List of Cables

Function	P/N	Length
For Start/Stop control in automated machines	101-240-020R	Start Cable (J911) 8' (req PLA)
	101-240-015R	Start Cable (J911) 15' (req PLA)
	101-240-010R	Start Cable (J911) 25' (req PLA)
For Status/Alarm interfacing to automated machines	101-240-021R	Alarm Cable J971, 8 ft.
	101-240-016	Alarm Cable J971, 15 ft.
	101-240-011R	Alarm Cable J971, 25 ft.

4.4 Installation Requirements

This section covers the location options, dimensions of the major assemblies, environmental requirements, electrical requirements and factory air requirements, to help you plan and execute your installation successfully.

4.4.1 Location

The Integrated Welder should only be operated in the vertical position. The Welder (on a base) is often manually operated, using its base-mounted start switches, and so is installed at a safe and comfortable workbench height (approximately 30-36 inches) with the operator sitting or standing in front of the system. Stands (on hubs) are often used in automated systems and may be manually or automatically loaded and unloaded.

WARNING	General Warning
	<p>The stand may tip over if moved around the axis of its column, if not properly secured. The work surface on which a stand is installed must be sturdy enough to support it, and secure enough to not tip over when the stand is adjusted during installation or setup.</p>

The internal power supply module must be accessible for user parameter changes and settings, so considerations must be made to be able to access the DIP switches. The Welder should be positioned so it does not draw in dust, dirt or material via its internal fan. Consideration should also be given to rear electrical and pneumatic connections, approximately 6 in/150 mm. Refer to the illustrations on the pages that follow for a dimensional drawing of each component. All dimensions are approximate and may vary between models.

Figure 4.4 2000IW/IW+ Integrated Welder Dimensional Drawing

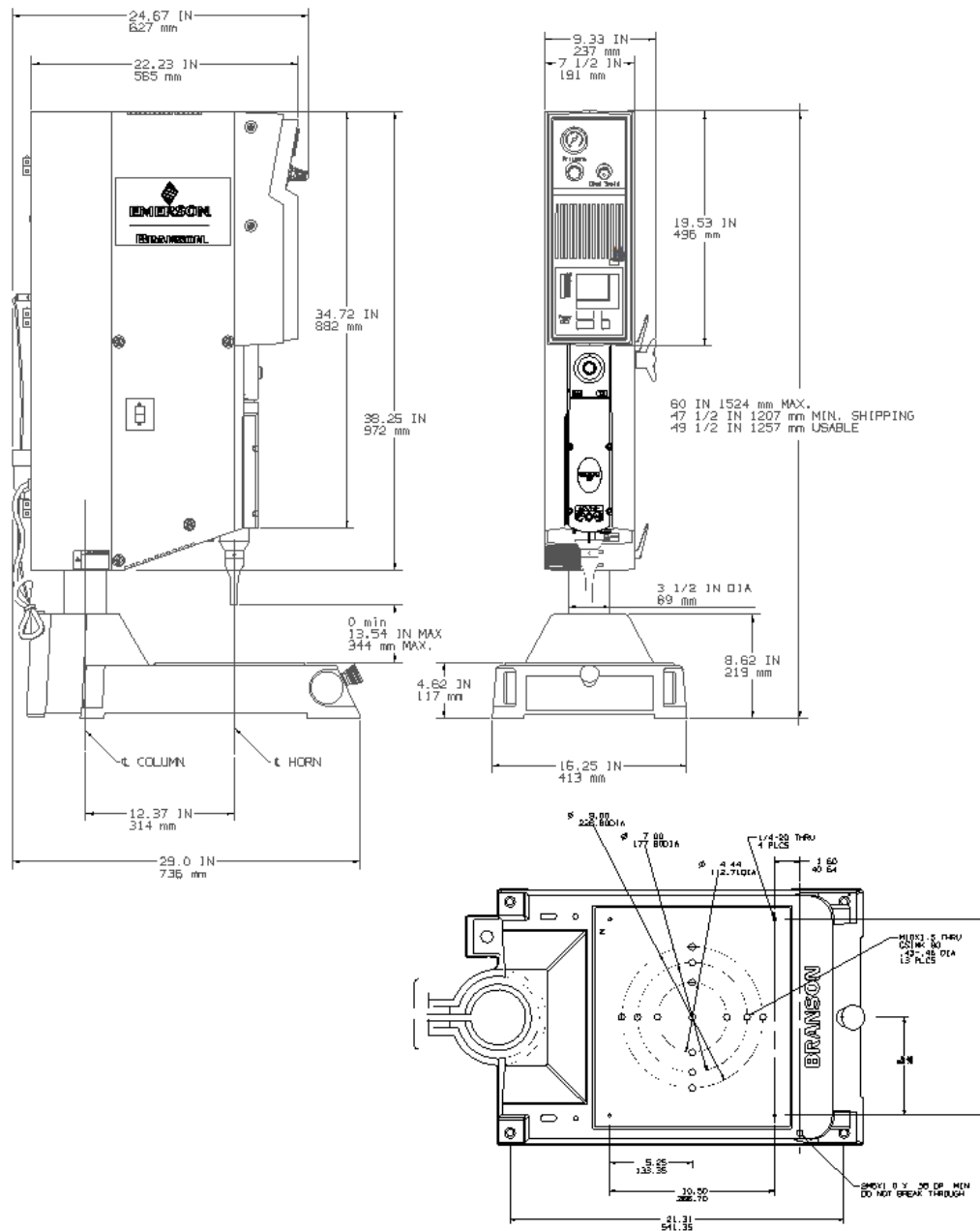

Caution: Before inserting screws into the base holes,
 1. Check the thread ID on the base.
 2. For M (mm), use M10-1.5 cap screws.

4.4.2 Environmental Specifications

Table 4.3 Environmental Specifications

Environmental Concern	Acceptable Range
Humidity	30% to 95%, non-condensing
Ambient Operating Temperature	+5° C to +50° C (41° F to 122° F)
Operating Altitude	Up to 1000 m
IP Rating	2X

4.4.3 Electrical Input Power Ratings

Plug the Welder into a single-phase, grounded, 3-wire, 50 or 60 Hz power source. lists the current and fuse ratings for the various models.

Table 4.4 Input Power Requirements

Power	Current Rating	NEMA Connector
1100 W 100V - 120V	13 Amp Max. @ 100V / 17 Amp CB	NEMA 5-15P Plug
1100 W 200V - 240V	6.5 Amp Max. @ 200V / 8 Amp CB	None supplied
2200 W 200V - 240V	14 Amp Max. @ 200V / 17 Amp CB	None supplied
3300 W 200V - 240V	21 Amp Max. @ 200V / 20 Amp CB	None supplied

4.4.4 Factory Air

The factory compressed air supply must be “clean (to a 5 micron level), dry and unlubricated” air with a regulated maximum pressure of 100 psig (690 kPa). Depending on your application, the welder requires between 35 to 100 psi. Stands include an in-line air filter. Welders on Stands require a customer-provided air filter. Use a lockout device on the air line if required.

CAUTION	General Warning
	<p>Synthetic air compressor lubricants containing Silicone or WD-40 will cause internal welder damage and failure due to the solvents contained within these types of lubricants.</p>

CAUTION	General Warning
	<p>There should be no substitute for clean, dry air to run the welder. Use of other types of gas could lead to premature degradation of seals. Contact your Branson representative if you have any concerns.</p>

4.4.4.1 Air Filter

The 2000IW/IW+ Integrated Welders have an input air filter which protects from particulate matter of 5 microns or larger.

4.4.4.2 Pneumatic Connections

Air connection to the unit is made to the AIR INLET connector on the lower rear of the Integrated Welder, with plastic pneumatic tubing. For installations using Welder/Stand assemblies, you must provide an air filter assembly which will support to at least 100 psig and remove particulate matter of 5 microns or larger.

4.4.4.3 Compressed Air Supply Connections

It is important to prevent impurities and moisture from entering through the air lines and damaging your equipment. To facilitate this when installing your welder, use an air line hookup that includes a riser and waterleg (Refer to [Figure 4.5 Hooking Up the Air Line](#)). Connect the air line to a clean (5 micron), unlubricated, dry, compressed air supply, 35 to 100 psi (240 to 690 kPa). Use the supplied, self draining air filter with a 5 micron element.

CAUTION	General Warning
	<p>Permanent damage to the gauge may result if operated above the maximum gauge reading (100 psi/690 kPa) or below the minimum (35 psi/240 kPa).</p>

Set the pressure regulator to zero before connecting or disconnecting the air supply.

Figure 4.5 Hooking Up the Air Line

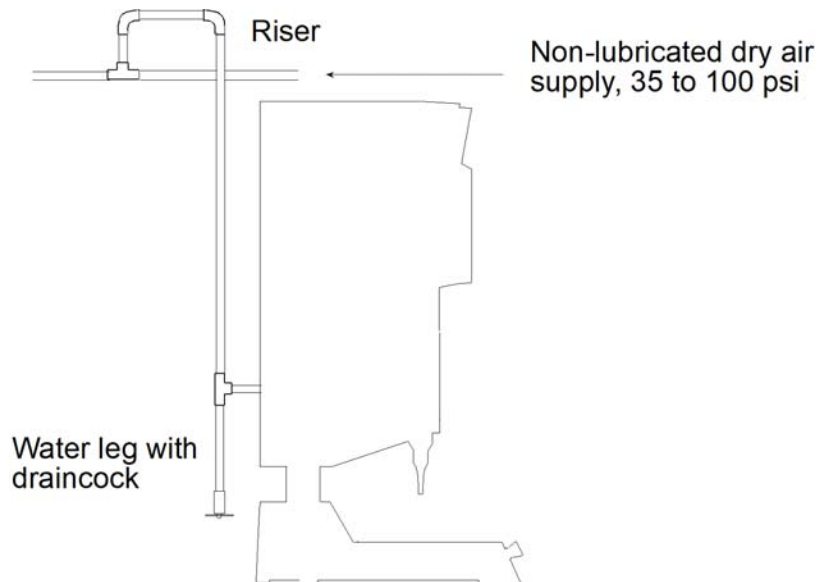

4.5 Installation Steps

CAUTION	Heavy Object
	<p>This product is heavy and can cause a pinching or crushing injury during installation or adjustment. Keep clear of moving parts and do not loosen clamps unless directed to do so.</p>

4.5.1 Mounting the Stand (Integrated Welder on Base)

The base must be bolted to your workbench to prevent tipping or undesired movement. Four mounting bolt holes are provided at the corners of the casting, and will accept your 3/8 inch or M10 cap screws. Use flat washers against the metal casting to prevent gouging. Refer to [Figure 4.6 Base Mounting Centers](#).

CAUTION	General Warning
	<p>You must secure the base to your work surface using four bolts, to prevent tipping or undesired movement, in the event the welder is moved off-center or rotated around the column.</p>

1. Ensure there are no overhead obstructions and that no pinch or rub points exist. Remember that the welder is taller than the column when fully raised, and there are exposed connections
2. Mount the base to your workbench using four socket-head cap screws (customer provided, 3/8 inch (US bases) or M10 (metric bases)). Use flat washers against the metal casting to prevent gouging. The use of nylon lock nuts with your cap screws is suggested, to reduce loosening due to vibration and movement
3. Connect factory air to the air input on the rear of the Welder. Use a lockout device on the air line if required
4. Verify the base/start switch control cable is properly connected to the **back of Welder**.

Figure 4.6 Base Mounting Centers

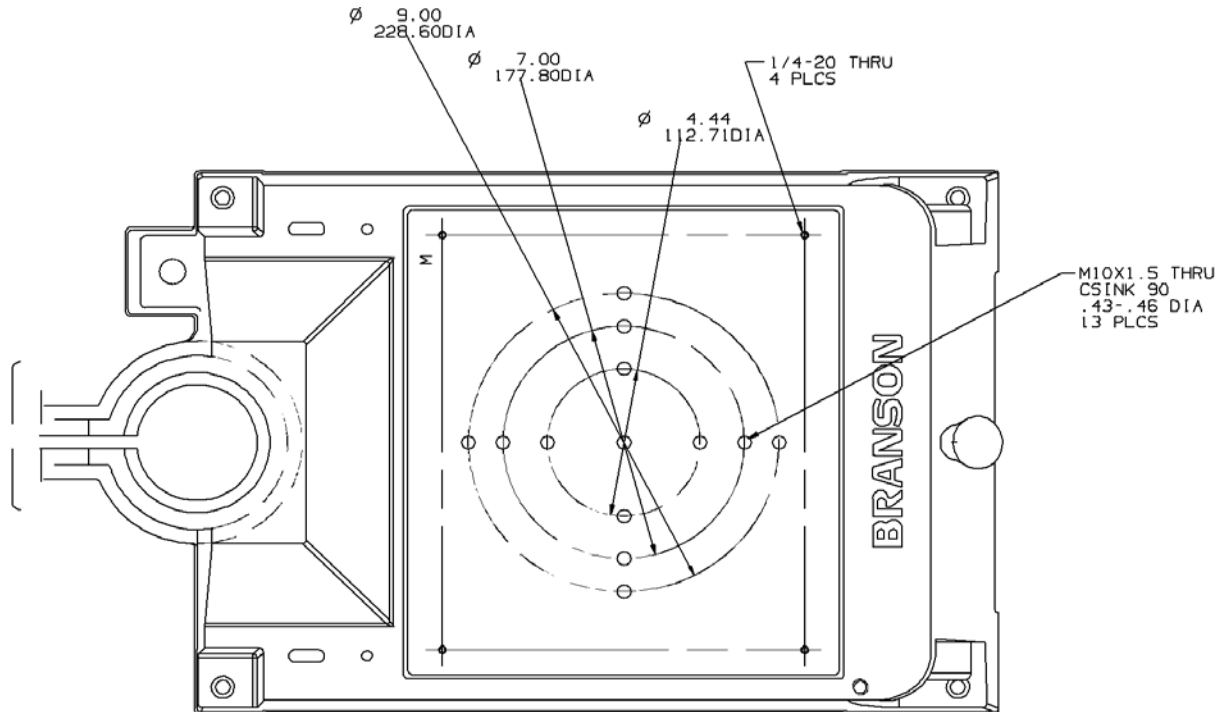

4.5.2 Mounting the Stand (Welder on Hub-mounted column)

During unpacking, you removed the hub from the column/stand assembly. You must choose a mounting location for the hub that will support the column and actuator, and provide the hardware to mount it. Four mounting bolt holes are provided at the corners of the casting, and will accept your 3/8 inch or M10 hardware. Use flat washers against the metal casting to prevent gouging. Refer to [Figure 4.8 Start Switch Connection Codes](#).



CAUTION	General Warning
	<p>The hub must be installed with its front in the same direction as the front of the welder. The column bolts of the hub are found on the rear of the hub. See Figure 4.6 Base Mounting Centers for mounting details.</p>

Figure 4.7 Mounting Bolt Pattern for the Hub (for Stand on Hub)

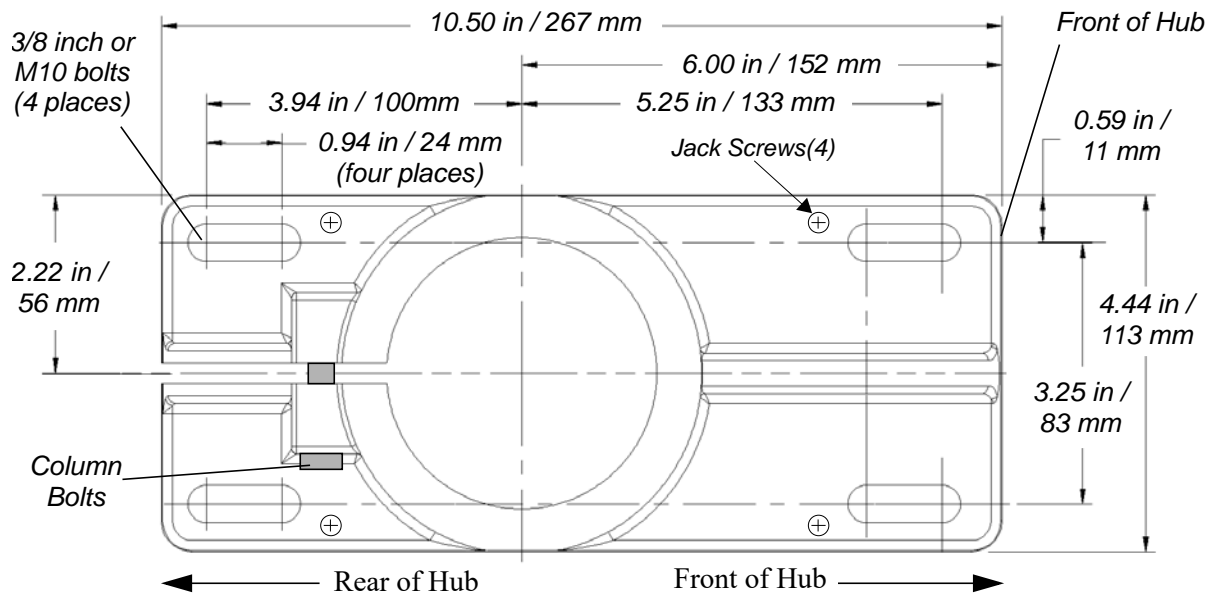

1. Locate the hub in the desired location. Ensure no overhead or side obstructions will interfere with normal operation or use of the system.

CAUTION	General Warning
	<p>Mount the hub to your work surface using four bolts, 3/8-inch or M10 shank size, with flat washers against its metal casting (customer provided hardware).</p>

2. Carefully lift the welder and column assembly, and mount the column in the hub. Align the flat face of the spring swivel with the top-front of the welder. Tighten the two bolts on the hub
3. Connect factory air to the air input on the rear of the welder. Use a lockout device on the air line if required
4. Verify the base/start switch control cable is properly connected to the **back of welder**
5. Use jack screws to fine adjust the system level. A 3/16" Allen wrench should be used for the 3/8"-16 x 3/4" jack screws

4.5.3 Input Power (Main)

The system requires single-phase input power, which you connect to the Welder using the integral power cord. See [Table 4.4 Input Power Requirements](#) for plug and receptacle requirements for your specific power level.

Refer to the unit's Model Data Tag to be sure of the power rating of the Model in your system.

Open the left side cover door of your welder and locate the Line Voltage Selector Jumper. figure: Line Voltage Selector Jumper

The voltage select is 100-120 or 200-240 Volts, depending on model. You may need to replace the circuit breaker/power switch to coincide with the voltage setting.

Close and secure the cover door.

4.5.4 Start Switch Connection (Automation)

A Branson Integrated Welder requires 2 start switches and emergency stop connection. Stands on a base include this connection (factory installed and connected from the base) while the stand on a hub applications require the user make their own start switch/E-stop connections, as follows:

Figure 4.8 Start Switch Connection Codes

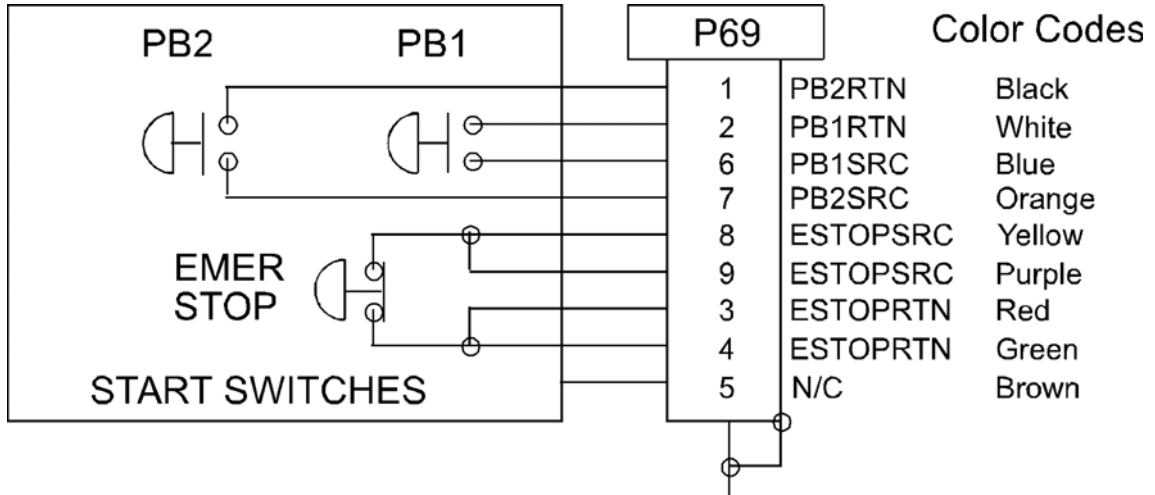

NOTICE	
	<p>Solid state devices may be used in lieu of mechanical start switches providing their leakage current does not exceed 3.5 mA.</p>

NOTICE	
	<p>Start Switches PB1 and PB2 must be closed within 100 to 200 milliseconds of each other, and remain closed until the WELD ON signal is active, to effect a start condition.</p>

BASE/START is the DB-9 female connection on the back of the actuator. Your cable requires a male DB-9 (D-shell) connector.

PB1 and PB2 are two normally open start-switches which must be operated simultaneously to start the welding cycle. These must be closed within 200 milliseconds of each other, or error message: (ER28 or ER29) will display. This doesn't require a reset, but for the next cycle, switches must be within time limit to preclude re-occurrence of error message. Refer to Note above.

EMER STOP is an emergency stop switch, normally closed.

The welder can also be started by an EXTERNAL START signal. To do so, connect a J911 cable between the connector on the rear panel and your start signal (refer to [Figure 2.5 Rear Panel](#)).

WARNING	General Warning
	<p>If you wish to use a J911 cable, you must first have signed a Branson Product Liability Agreement.</p>

4.5.5 User I/O, Alarm Connector

The Alarm Connector provides status outputs and an EXTERNAL RESET switch connection to customer supplied controls. Connection is via a J971 cable from the 25 pin connector on the welder's rear panel. The cable is available in 8 ft/2.5 m, 15 ft/4.5 m, or 25 ft/7.5 m lengths.

The EXTERNAL RESET switch operates in exactly the same manner as the front panel RESET switch, Applying +24V DC to the EXTERNAL RESET input (pin 25) for a minimum of 20 ms will reset the welder.

The status outputs available from the interface are SOLENOID OUTPUT (pin 13), GENERAL ALARM (pin 18), READY (signal - pin 19, relay - pins 9 and 10), and WELD ON (pin 20). The SOLENOID OUTPUT provides a *negative logic output* when referenced to the +24V DC source (pins 5 and 6). GENERAL ALARM, READY AND WELD ON signals provide a negative logic output when reference to 24V RTN (pins 21, 22, and 23).

These signals can be interfaced with a customer supplied device to monitor system status and trigger some action when the signals become active or inactive.

Pins 5 and 6 provide a +24V DC source (100mA maximum). Pins 21, 22, and 23 provide +24V DC return (common). The remaining pins are unused. Refer to [Figure 4.9 Input/Output Signals, IW/IW+](#).

Figure 4.9 Input/Output Signals, IW/IW+

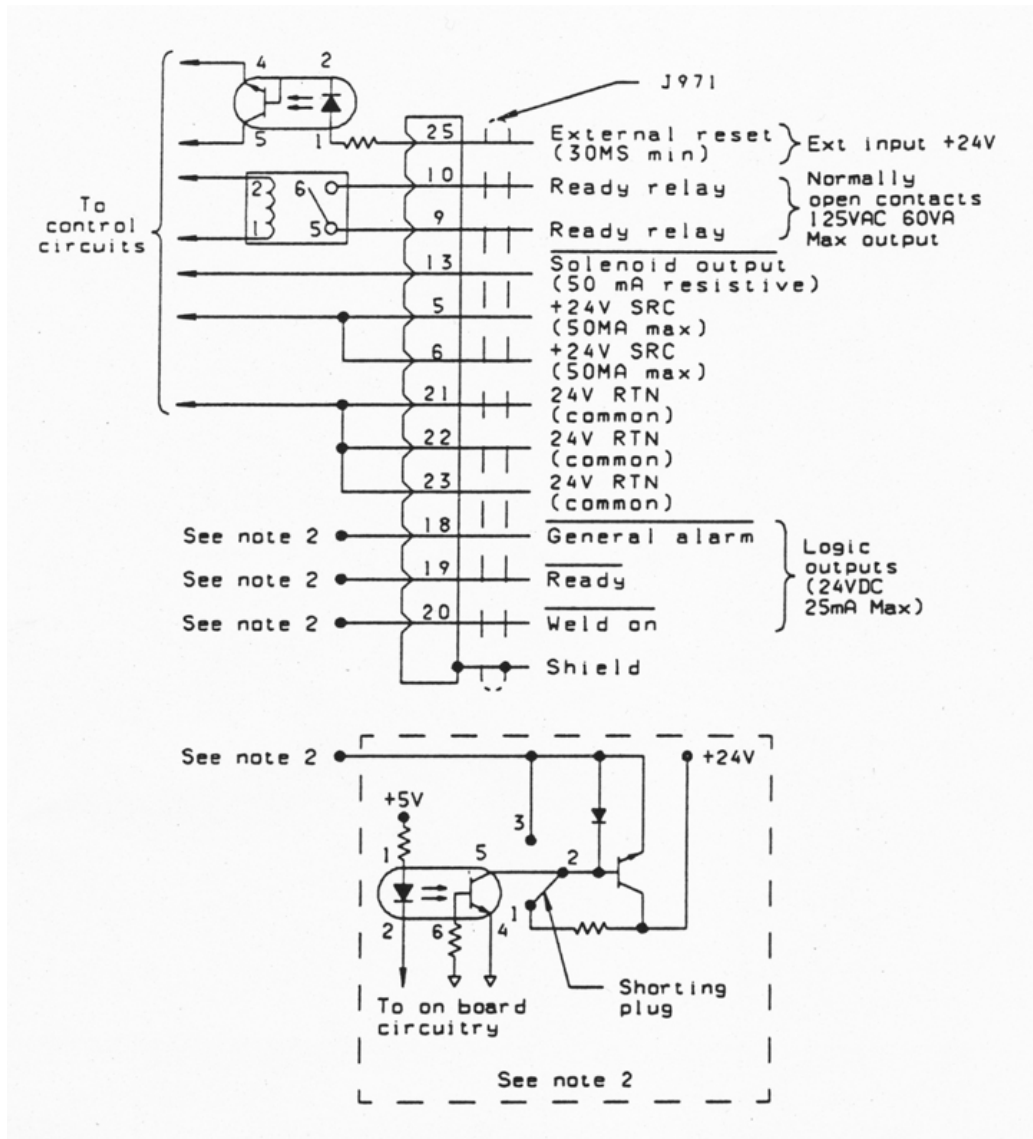

Note 1: The following pins are not connected: 1, 2, 3, 4, 7, 8, 11, 12, 14, 15, 16, 17, and 24.

Note 2: Typical Circuitry for Pins 18, 19, and 20.

CAUTION	General Warning
	<p>Ensure all unused wires are properly isolated. Failure to do so may result in power supply module or system failure.</p>

Figure 4.10 Operating Cycle Timing Table, 2000IW

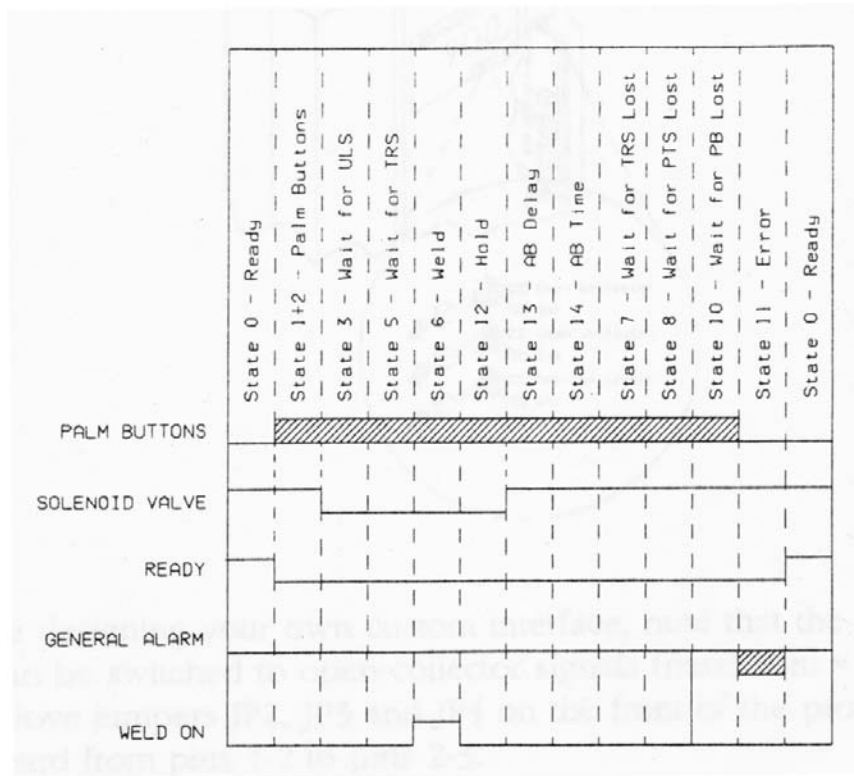

Figure 4.11 Operating Cycle Timing Table, 2000IW+

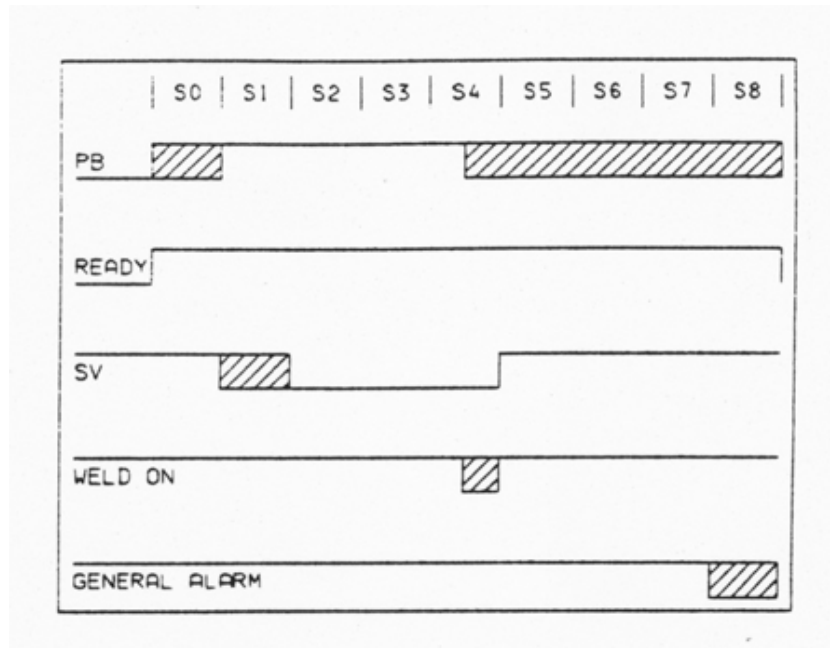
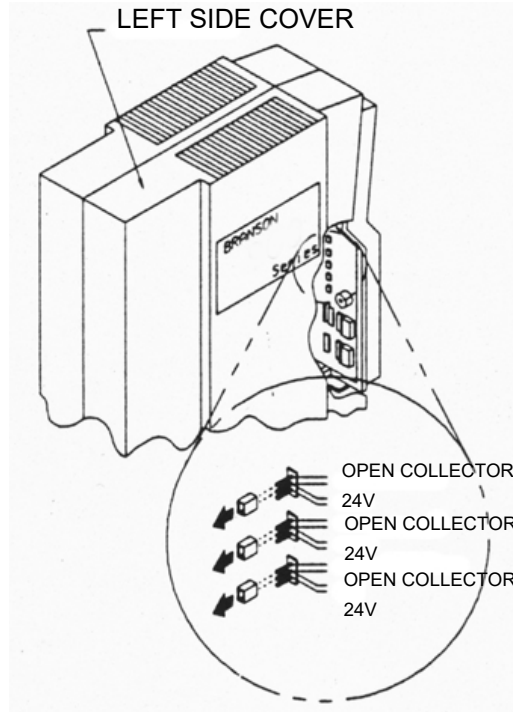

Figure 4.12 Moving Jumpers



If you are designing your own custom interface, note that the +24V DC signals can be switched to open-collector signals (maximum +24V DC, 25mA) by moving jumpers JP2, JP3 and JP4 on the front of the controller circuit board from pins 1-2 to pins 2-3. The output circuit ground signal can be isolated by cutting the 0 ohm resistor (R79) on the control board.

4.5.6 Input Power Plug

If you must add or change the input power plug, use the following color code for the conductors found in the international harmonized line cord. Add the plug that is appropriate for your input power receptacle.

CAUTION	General Warning
	<p>The power supply module can be permanently damaged if it is connected to the incorrect line voltage, or if the wiring connection is mis-wired. It also presents a safety hazard if mis-wired. Use of the correct plug or connector helps prevent incorrect connections.</p>

Figure 4.13 International Harmonized Line Cord Color Code



4.5.7 Power Supply Module Options DIP Switch

DIP switch changes the Seek and Start functions and can affect the Amplitude Control functions.

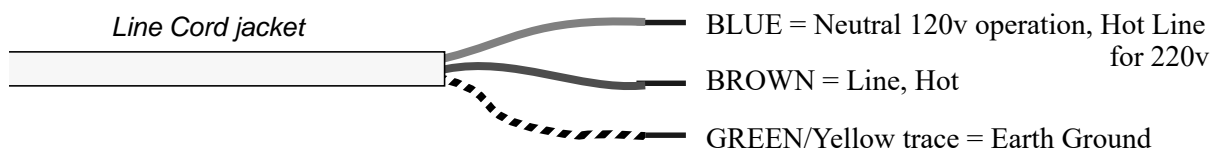
There are two DIP switches that Branson uses interchangeably. [Figure 4.14](#) and [Figure 4.15](#) illustrate each of them. Default operational settings are provided in the Tables.

CAUTION	General Warning
	<p>The components in the Power Supply section of the Integrated Welder are subject to damage from electro-static discharge. When working inside the Integrated Welder, use a grounded wrist strap and minimize your movement to reduce the possibility of damage due to static electricity.</p>

WARNING	General Warning
	<p>Unplug the welder (if previously connected) and wait at least two (2) minutes before opening the case. Hazardous Voltages exist and are stored in the system.</p>

4.5.7.1 Options for Setting the Type 1 Switch Select Block

Figure 4.14 Type 1 DIP Switch Marked "OPEN" on Top of Switch, Default Settings

Marked "OPEN" on top of switch

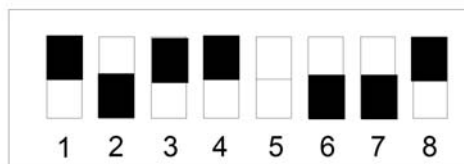

POSITION	UP	DN	UP	UP	NC	DN	DN	UP
SWITCH	1	2	3	4	5	6	7	8

NOTICE	
	<p>Toggle 5 is not used.</p>

Table 4.5 Options for Setting the Type 1 Switch Select Block

Function	Option	Set Toggles
Seek	Seek on power up – Checks horn frequency upon power up and stores it in memory.	1 – Down (Off) 1 – Up (On)
	Auto Seek – Checks horn frequency once each minute, timed from the last activation of ultrasonics.	2 – Down (Off) 2 – Up (On)
	Auto Seek Duration – Indicates the length of time the Auto Seek function is active.	3 – Down (500 ms) 3 – Up (100 ms)
	Store at End of Weld – Updates horn frequency memory at the end of each weld.	4 – Down (Off) 4 – Up (On)
Amplitude Control	Set for Fixed 100% Amplitude, Variable turned Off	6 – Down (Off)
Start	Short – Sets ramp time to 10 ms.	7 – Down 8 – Down
	Medium – Sets ramp time to 35 ms.	7 – Up 8 – Down
	Standard** – Sets ramp time to 80 ms.	7 – Down 8 – Up
	Long – Sets ramp time to 105 ms.	7 – Up 8 – Up

** The default Start setting is "Standard".

4.5.7.2 Options for Setting the Type 2 Switch Select Block

Figure 4.15 Type 2 DIP Switch Marked "ON" on face of Switch, Default Settings

Marked "ON" on face of switch

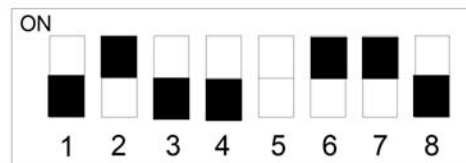

POSITION	DN	UP	DN	DN	NC	UP	UP	DN
SWITCH	1	2	3	4	5	6	7	8

NOTICE	
	Toggle 5 is not used.

Table 4.6 Options for Setting the Type 2 Switch Select Block

Functions	Options	Set Toggle
Seek	Seek on power up – Checks horn frequency upon power up and stores it in memory.	1 – Down (Off) 1 – Up (On)
	Auto Seek – Checks horn frequency once each minute, timed from the last activation of ultrasonics.	2 – Down (Off) 2 – Up (On)
	Auto Seek Duration – Indicates the length of time the Auto Seek function is active.	3 – Down (100 ms) 3 – Up (500 ms)
	Store at End of Weld – Updates horn frequency memory at the end of each weld.	4 – Down (Off) 4 – Up (On)
Amplitude Control	Set for Fixed 100% Amplitude, Variable turned Off.	6 – Up (On)
Start	Short – Sets ramp time to 10 ms.	7 – Down 8 – Down
	Medium – Sets ramp time to 35 ms.	7 – Up 8 – Down
	Standard** – Sets ramp time to 80 ms.	7 – Down 8 – Up
	Long – Sets ramp time to 105 ms.	7 – Up 8 – Up

** The default Start setting is "Standard".

4.6 Accessory Input/Output Option

This feature is available as an option, usually referred to as “Advance Features”. It allows access to:

- Power Output
- Memory Output
- Seek Output
- Frequency Output
- Frequency Offset Input
- Power Supply Module Status Outputs
- Amplitude Output
- Amplitude Control Input

The kit (101-063-721) provides the necessary hardware and instructions to retrofit the standard welder to utilize these features. The external cable provided (101-241-360R) in the kit is a 15 pin female to an open end. When the new rear mounting plate provided in the kit is installed, this cable will plug into the male 15 pin connector mounted topmost on this plate (refer to [Figure 2.5 Rear Panel](#)). The signals to the pinout are illustrated in [Figure 4.16](#).

Figure 4.16 Accessory Input/Output Connector Pinout

COMMON	1
+10VREF	2
POWER	3
MEMORY	4
RUN OUT	5
MEMORY STORE	6
EXT SEEK+	7
N/C	8
AMPLITUDE IN	9
AMPLITUDE OUT	10
FREQ OUT	11
FREQ OFFSET	12
SEEK	13
MEMORY CLEAR	14
EXT SEEK-	15

4.7 Guards and Safety Equipment

4.7.1 Emergency Stop Control

If you use the Emergency Stop button on the Welder to terminate a weld, twist the button to reset it. (The welder will not operate until this button is reset.) If you are running automation, you can use external reset that is connected to your User I/O board.

Figure 4.17 Integrated Welder Emergency Stop Button

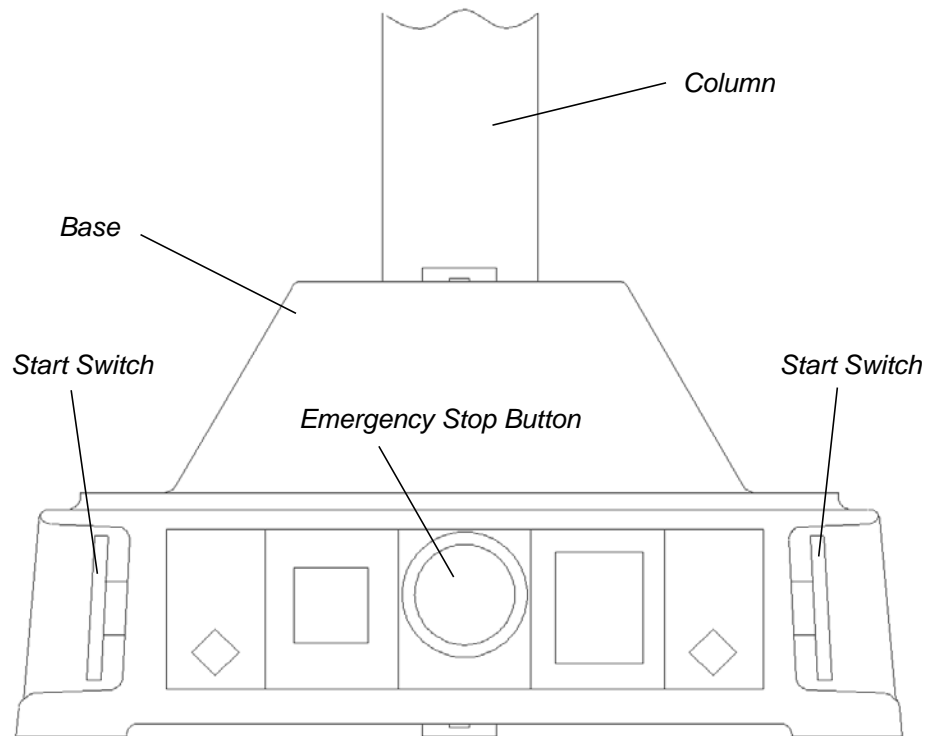

If you are using an Emergency Stop signal from the Start Switch cable, you must clear the Emergency Stop condition before the System will operate.

4.8 Assemble the Acoustic Stack

WARNING	General Warning
	<p>To prevent personal injury or damage to the equipment or workpiece being welded, always hold the welder in place before releasing the column clamps. This procedure may require two persons.</p>

If the converter and booster are not assembled, perform the steps in [Table 4.7](#).

CAUTION	General Warning
	<p>The following procedure must be performed by a setup person. If necessary, secure the largest portion of a square or rectangular horn in a soft jawed vise. NEVER attempt to assemble or remove a horn by holding the converter housing or the booster clamp ring in a vise.</p>

CAUTION	General Warning
	<p>Do not use silicone grease with Mylar washers. Use only 1 (one) Mylar washer of the correct inside and outside diameters at each interface.</p>

Table 4.7 Assemble the Acoustic Stack

Step	Action
1	Raise the welding head by loosening the upper and lower column clamps and turning the elevation knob clockwise. After raising the head, re-tighten the column clamps.
2	Open the carriage door by loosening the captive screws.
3	Clean the mating surfaces of the converter, booster, and horn. Remove any foreign material from the threaded holes.
4	Install the threaded stud into the top of the booster. Torque to 450 in-lbs, 50.84 Nm. If the stud is dry, apply 1 or 2 drops of a light lubricating oil before installing.
5	Install the threaded stud into the top of the horn. Torque to 450 in-lbs, 50.84 Nm. If the stud is dry, apply 1 or 2 drops of a light lubricating oil before installing.

Table 4.7 Assemble the Acoustic Stack

Step	Action
6	Install a single Mylar washer (matching the size of the washer to the stud) to each interface.
7	Assemble the converter to the booster and the booster to the horn.
8	Torque to 220 in-lbs, 24.85 Nm.

Table 4.8 Tools

Tool	EDP Number
20 kHz Torque Wrench	101-063-787
20 kHz Spanner Wrench	101-118-039

Figure 4.18 Assembling the 20kHz Acoustic Stack, Rectangular Horn

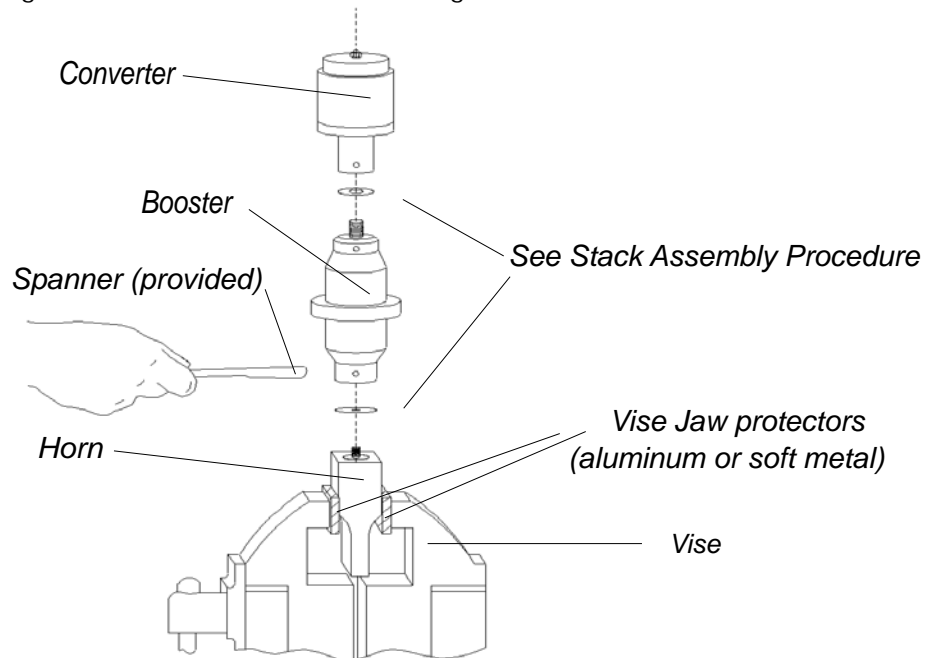
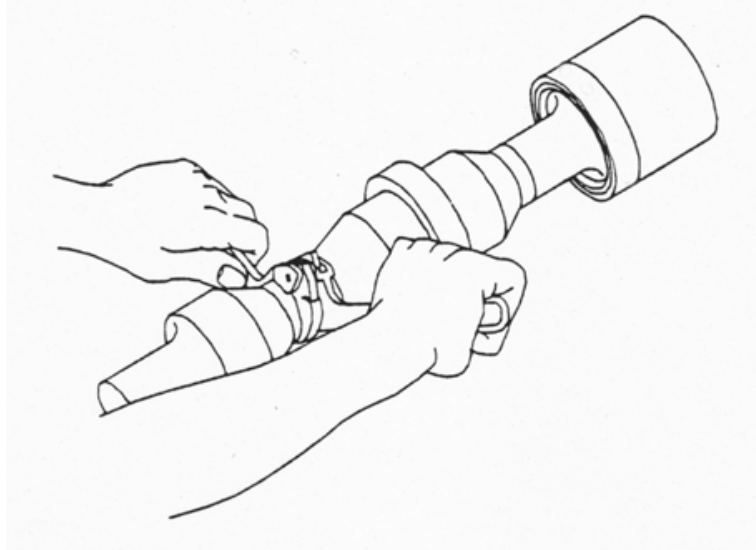

Figure 4.19 Assembling the 20kHz Acoustic Stack, Cylindrical Horn



Stack Assembly Torque Tables

NOTICE	
	<p>The use of a Branson torque wrench or the equivalent is recommended. P/N 101-063-787 for 20 kHz systems.</p>

Table 4.9 Stud Torque Values

Used On	Stud Size	Torque	EDP#
20 kHz	3/8" x 24 x 1"	290 in lbs, 33 Nm	100-098-120
20 kHz	3/8" x 24 x 1-1/4"	290 in lbs, 33 Nm	100-098-121
20 kHz	1/2" x 20 x 1-1/4"	450 in.-lbs, 50.84 Nm	100-098-370
20 kHz	1/2" x 20 x 1-1/2"	450 in.-lbs, 50.84 Nm	100-098-123

4.8.1 Connecting Tip to Horn

1. Clean the mating surfaces of the horn and tip. Remove foreign matter from the threaded stud and hole
2. Hand assemble the tip to the horn. Assemble dry. Do not use any silicone grease
3. Use the spanner wrench and an open-end wrench (Refer to [Figure 4.20 Connecting Tip to Horn](#)) and tighten to the following torque tip specifications:

Table 4.10 Tip to Horn Torque value

Tip Thread	Torque
1/4 - 28	110 in.-lbs, 12.42 Nm.
3/8-24	180 in.-lbs, 20.33 Nm.

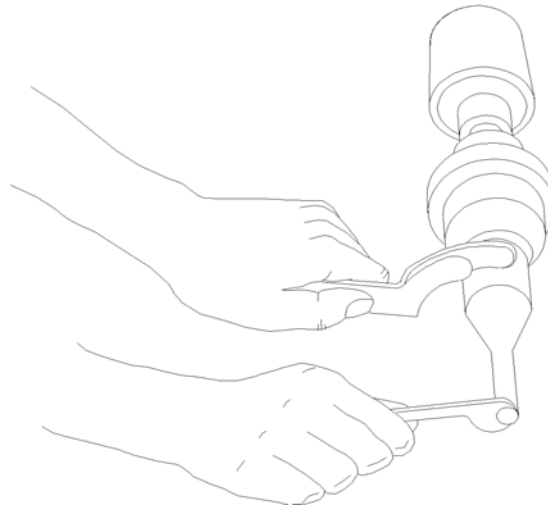
Figure 4.20 Connecting Tip to Horn

4.9 Installing the Ultrasonic Stack in the Integrated Welder

WARNING	General Warning
	<p>To prevent personal injury or damage to the equipment or workpiece being welded, always hold the welder in place before releasing the column clamps. This procedure may require two persons.</p>

The ultrasonic stack must first be assembled. To install the stack:

1. Make sure that the system power is turned off by disconnecting the power plug
2. If necessary, raise the welding head by loosening the upper and lower column clamps and turning the elevation knob clockwise. After raising the head, re-tighten the column clamps
3. Loosen the four door screws
4. Pull the door straight off and set it aside
5. Take the assembled ultrasonic stack and align the ring on the booster just above the support washer in the carriage. Firmly push the stack into place, with the acorn nut on the top of the converter making contact with the contactor in the top of the carriage
6. Reinstall the door assembly, and start the four door screws
7. Align the horn by rotating it, if necessary. Torque the carriage door to 20 in.-lbs to secure the stack

Figure 4.21 Installing a 20kHz Stack in a Branson Welder

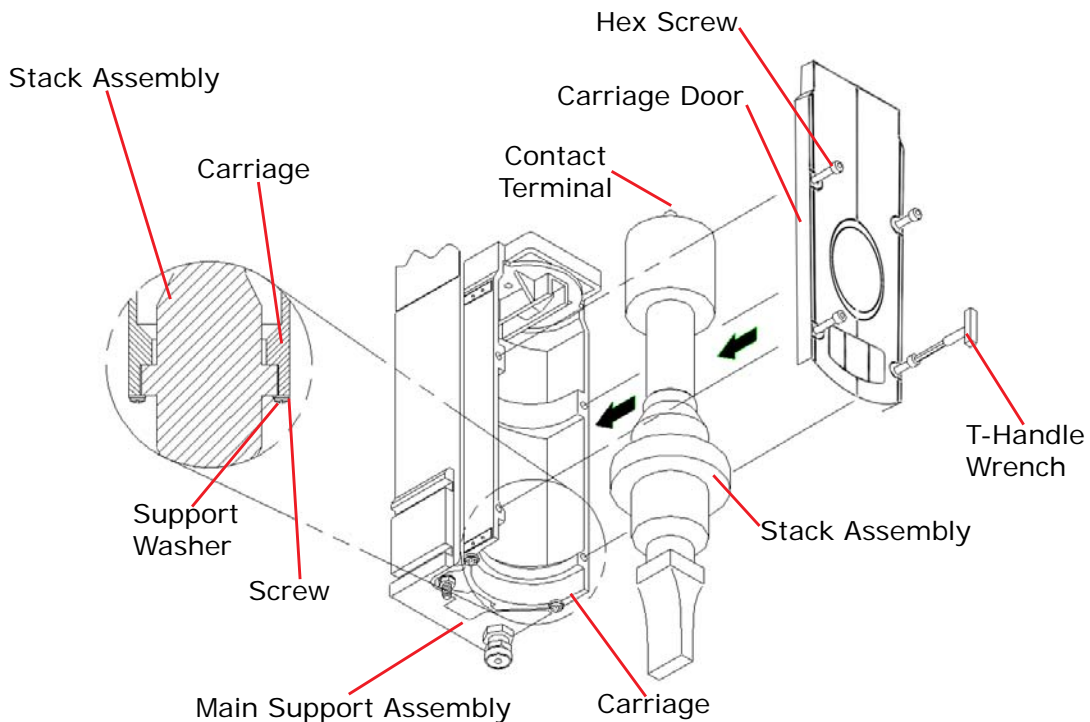

4.9.1 Mounting the Fixture on the Branson Base (hardware and mounting holes)

The base provides mounting holes for your fixture. Mounting holes are also provided for the optional Branson leveling plate kit, which can be ordered in inch or metric. The base is a tapped for metric M10-1.5 hardware. The mounting holes are arranged in three concentric bolt circles with the following dimensions.

CAUTION	General Warning
	<p>The base is cast metal and the mounting holes can become stripped if the hardware is overtightened. Tighten your hardware only enough to prevent movement of your fixture.</p>

Figure 4.22 Mounting Circles on Base



The optional guard (sometimes required with very large horns,) is shown for position only. It extends several inches to either side of the base, and prevents the user from operating the welder and pinching their fingers or hands between the base and the tooling.

4.10 Adjusting Welder Height and Aligning the Horn

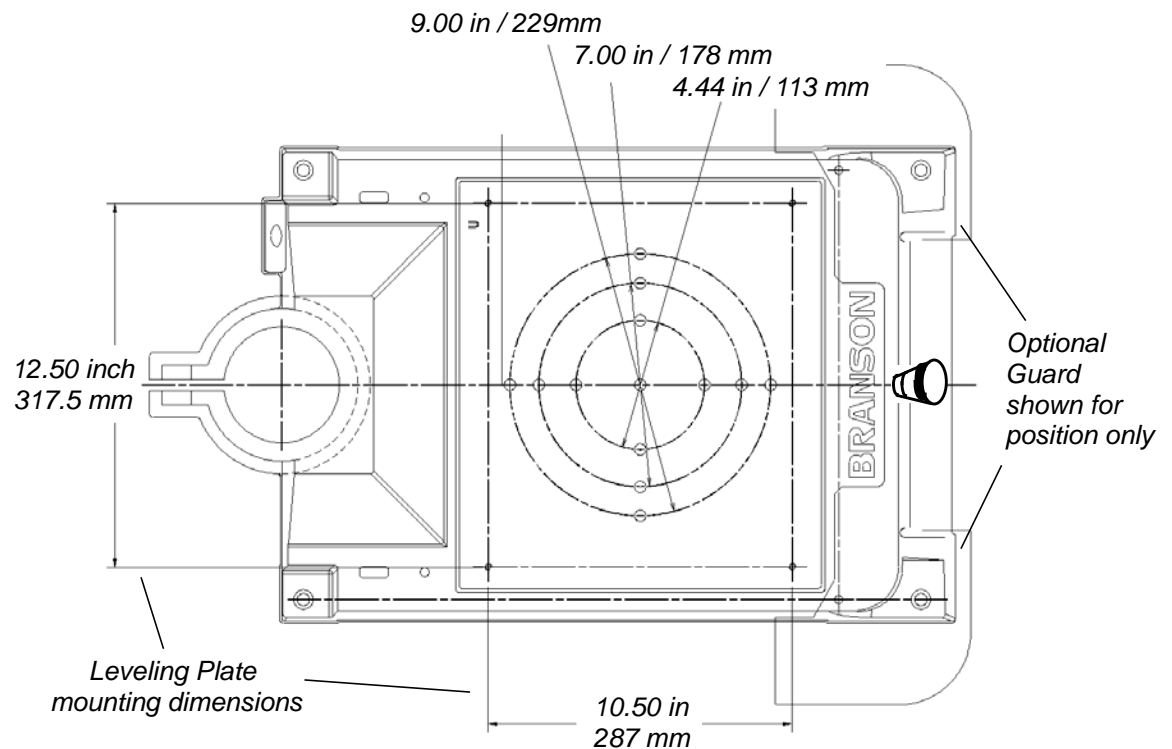
For maximum welding efficiency, position the welder so that the distance between the workpiece and the horn is at a minimum; however leave enough room to allow for easy removal of the workpiece from the fixture.

As the maximum travel of the carriage is 4 in/101.6 mm (minimum 1/4 in/6.35 mm), take care to ensure that the horn contacts the workpiece before the carriage is close to the limit of its travel. Under such conditions, the carriage may bottom out at maximum trigger pressure before reaching the full depth of weld.

Set the welder height as follows:

1. Position the fixture loosely on the work surface, On the base, use the M 10 x 1.5 threaded holes.

CAUTION	General Warning
	<p>Before inserting screws into the base holes:</p> <ol style="list-style-type: none"> 1. Check the thread ID on the base. 2. For m (mm) use M10 x 1.5 cap screws.

2. Holding the welder in place, loosen the two column clamps.

WARNING	General Warning
	<p>To prevent personal injury or damage to the equipment or workpiece being welded, always hold the welder in place before releasing the column clamps. This procedure may require two persons.</p>

3. Use the elevation handle to adjust the height of the welder for the desired stroke length. For proper triggering, provide a minimum stroke length of 1/4 inch. Then tighten the column clamps.
4. Place the workpiece to be welded in the fixture.
5. Set the pressure regulator to zero and manually lower the carriage until the horn contacts the workpiece.
6. Loosen the carriage door screws and rotate the stack until the horn is properly aligned with the workpiece. Tighten the carriage door screws.
7. Adjust the air pressure to 15 psi.
8. Use HORN DOWN to check the fixture's position. Press HORN DOWN, then the START SWITCHES. The horn will descend and remain down under pressure, although ultrasonic energy will remain off. While holding the horn against the workpiece, tighten the fixture on the base plate. Further leveling of the fixture may be required, as indicated by test welding results.
9. Press HORN DOWN again to raise the horn back into its normal position.

4.11 Adjusting the Mechanical Stop

The mechanical stop limits the downward travel of the horn. To prevent equipment damage, adjust the stop so that the horn will not contact the fixture or nest when no workpiece is in place.

Figure 4.23 Adjusting the Mechanical Stop

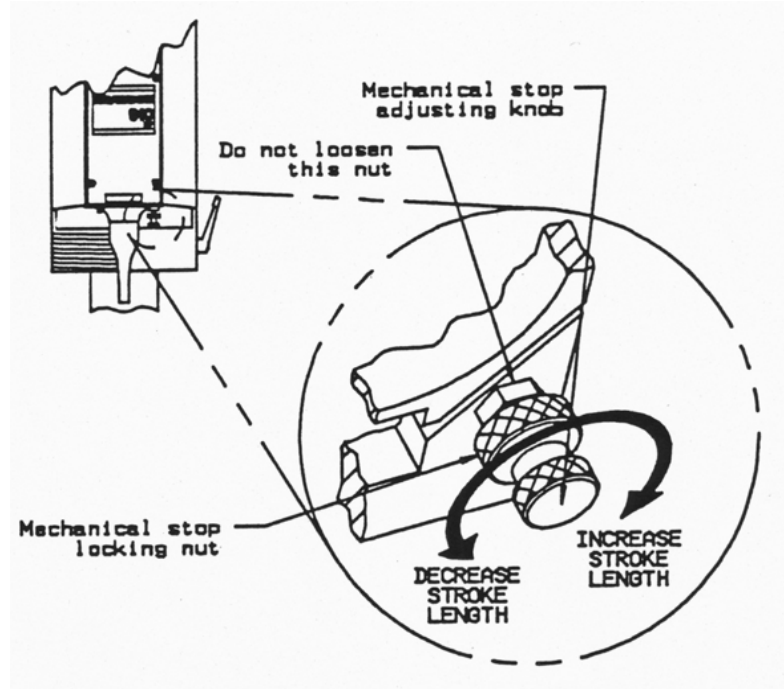

1. Reduce the pressure to zero and manually lower the carriage until the horn is just above the fixture.
2. If the horn does not reach the fixture and has not traveled 4 in. (101.6 mm), loosen the lock nut and turn the mechanical stop adjusting knob clockwise until the carriage reaches the desired position.

If the horn reaches the desired position before contacting the stop, turn the adjusting knob counterclockwise until the stop contacts the carriage.

3. Recheck the clearance between the horn and the fixture and make any necessary re-adjustments to the stop. You can use Horn Down (press HORN DOWN on the front panel) to check this position while the welder is under pressure.

NOTICE	
	<p>Turning clockwise will increase the stroke length; turning counterclockwise will shorten the stroke length. Adjustment is approximately 0.04 in/1mm per rotation.</p>

4. When the desired setting is obtained, tighten the locknut. The locknut will keep the mechanical stop adjustment from vibrating loose during operation.
5. Place a workpiece in the fixture, adjust the air pressure and perform a test weld.
6. Re-adjust the mechanical stop, if necessary.

4.11.1 Setting DIP Switches

WARNING	General Warning
	<p>Be sure the welder is electrically disconnected before opening the cover.</p>

- Open the left side cover to access the DIP switches which are located on the circuit board located on the lower right corner immediately behind the front panel.
- Use an insulated probe to alter DIP switch settings.
- After altering a DIP switch, close and secure the left side cover and plug in the power cord.

NOTICE	
	<p>These settings are different for the IW and the IW+, and read only at power-up.</p>

Figure 4.24 DIP Switch Location



4.11.1.1 IW + DIP Switch Settings

SW2-8 State Display Status: When ON, allows state digits (for example, State 1) to appear on the display, in place of weld time values when OFF. This display is in addition to the mode LEDs.

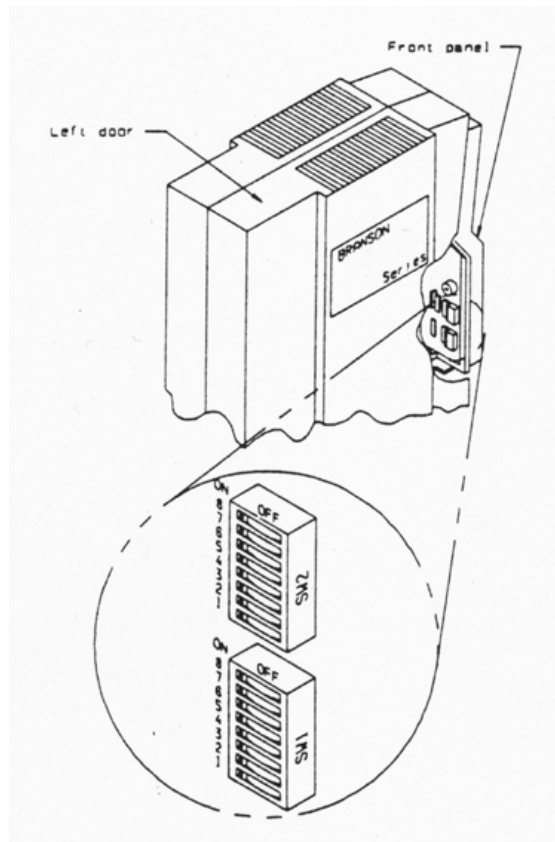
SW2-5 Display Lock: When ON, prevents any changes from being made to weld parameters except TEST, HOLD, and HORN DOWN. However, all parameters relating to the current weld mode are displayed and you can still restore cold start parameter values.

SW1-8 Units Status: When ON, selects SI units (mm), otherwise OFF selects USCS units (in.).

SW1-7 Test Scale Multiplier: In Test mode, affects the multiplier displayed on the POWER BARGRAPH. When ON, twice the actual power is displayed, when OFF, the actual power is displayed.

SW1-6 Weld Scale Multiplier: In Weld mode, affects the multiplier displayed on the POWER BARGRAPH during a weld cycle or when the peak power of the last weld is being displayed in READY state. When ON, twice the actual power is displayed; when OFF, the actual power is displayed.

SW1-5 Alarm Latch Status: When ON, alarms defined as *latchable* will prevent a weld cycle from running until RESET is pressed.

SW1-4 TRS Edge/Level: Selects either Edge (ON) or Level (OFF) to determine when the TRS signal is defined as "lost" during Weld or Hold time. Edge defines TRS lost a TRS input becoming inactive for more than 100 ms; Level defines TRS lost as TRS input becoming inactive for more than 10 ms.

SW1-3 Timing on ULS: This switch determines when weld timing will start. When ON, weld timing will be on the ULS. Otherwise (OFF - default setting) timing will be on the TRS when pretrigger ins enabled.

NOTICE	
	<p>Use SW1-3 ONLY WHEN ABSOLUTELY NECESSARY. It is not recommended for general use. When this switch is ON, you will never receive a WELD ON signal during the weld cycle.</p>

SW1-2: Not used.

SW1-1 Pretrigger on ULS: When ON, this switch allows ultrasonic energy to be pretriggered when the ULS becomes inactive.

4.11.1.2 IW DIP Switch Settings

SW2-7 LLS Logic Status: This switch determines in which logic state, 0V (Low, ON) or +24V (High OFF), the LLS is considered becoming active.

SW2-5 Display Lock: When ON, this switch prevents any change from being made to the weld parameters. HORN DOWN, TEST, and RESET can still be controlled from this choice.

SW1-8 LLS Alarm Function Status: This switch allows ultrasonics to be terminated on reaching a position in the stroke. When ON, the LLS signal (SW1, 7) is functional.

SW1-7 LLS Alarm Status: This switch selects the condition of the LLS signal that activates the LLS alarm; either ON when the alarm on the LLS signal becomes active

during the weld or hold time, or OFF when the alarm on the LLS signal is inactive by the end of the hold time. This switch is only functional if SW1, 7 has been activated.

SW1-6 Weld Scale Multiplier: In Weld mode, this switch affects the multiplier displayed on the POWER BARGRAPH during a weld cycle or when the peak power of the last weld is being displayed in READY state. When ON, twice (2x) the actual power is displayed, when OFF, the actual power (1x) is displayed.

SW1-5 Alarm Latch Status: This switch is used to determine whether weld cycles will be capable of activation after the welder has detected a "latchable" alarm condition. When this switch is ON, any alarms defined as "latchable" will prevent a weld cycle from bearing initiated until RESET is pressed.

SW1-4 TRS Edge/Level: This switch selects either Edge (ON) or Level (OFF) to determine when the TRS signal is defined as "lost" during Weld or Hold time. Edge defines TRS lost as TRS input becoming inactive for more than 100 ms; Level defines TRS lost as TRS input becoming inactive for more than 10 ms.

SW1-3 Timing on Pretrigger: This switch determines when weld timing will start. When ON, weld timing starts when the ULS signal is inactive. When OFF, weld timing starts when the Trigger switch (TRS) is active. This choice is only available if the pretrigger status (SW1, 1) is active.

NOTICE	
	Use SW1-3 ONLY WHEN ABSOLUTELY NECESSARY. It is not recommended for general use. When this switch is ON, you will never receive a WELD ON signal during the weld cycle.

SW1-2: Not used

SW1-1 Pretrigger on ULS: When ON, this switch allows ultrasonics to be pretriggered, based on the status of the Upper Limit Switch (ULS). Note that when timing is on the ULS, the weld active signal will not be activated.

4.12 Testing the Installation

1. Turn on the air supply connections, and verify that the system has air pressure.
2. Ensure there are no leaks in the air supply connections.
3. Turn on the Integrated Welder. The welder will begin its normal self-check.
4. Press the Start switches to complete the calibration.
5. Press the **Test** button.
6. If the Welder displays an alarm message at this point, find the alarm message definition in Section [6.5 Weld Cycle State Displays and Alarms](#). If there are no alarm messages displayed, go on to the next step.
7. Fit a test part onto the fixture.
8. Press the **Horn Down** key and then press and hold the two start switches. The horn will descend to the fixture on the base of the Welder. This verifies specifically that the pneumatic system is working.
9. Press the **Horn Down** key again. The horn will retract. The system should now be functional and can be set up for your application.

In summary, if the welder does not display an alarm message and the descends and retracts correctly, you are ready for operation.

Figure 4.25 Normal Front Panel Display after Power -Up, IW (left), IW+ (right)

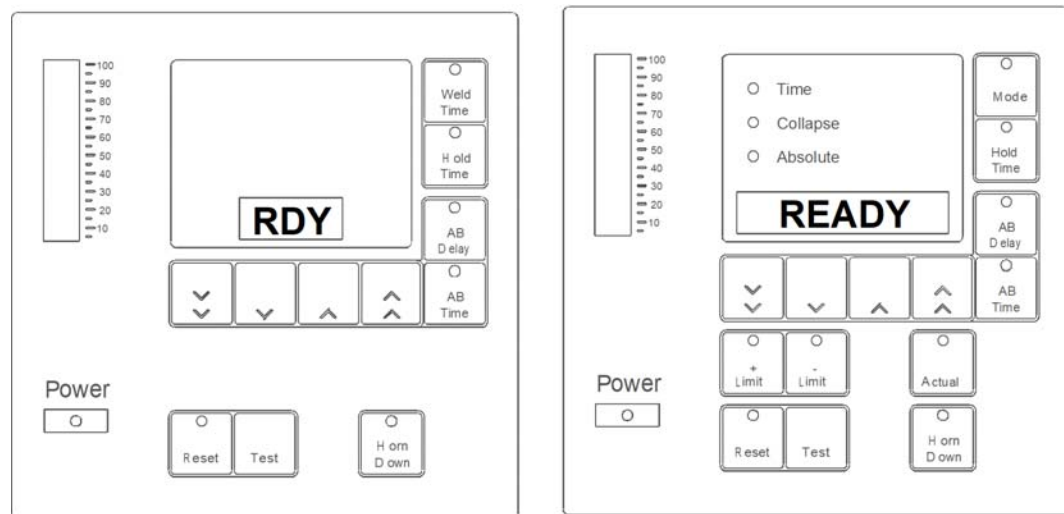

4.13 Still Need Help? or Parts? Have Questions?

Branson is pleased that you chose our product and we are here for you! If you need assistance with your 2000-series system, call your local Branson representative or contact Branson customer service by calling the appropriate department as indicated on [Table 1.1 Branson Contact](#), in Section [1.5.3 Departments to Contact](#).

Chapter 5: Technical Specifications

5.1 Technical Specifications 76

5.1 Technical Specifications

5.1.1 Physical Description

The Branson 2000 Series Integrated Welders, IW and IW+ Models, are self-contained ultrasonic plastics assembly systems that combine power supply, controls, indicators, and welding stand in a compact bench unit. Its compact footprint conserves work space. It can be used for ultrasonic welding, inserting, staking, spot welding, swaging, and degating thermoplastic parts. It can be operated manually, semi-automated or automated systems.

The Integrated Welder's control system is microprocessor-based, and controls the welding process while providing a level of user interface through a membrane keypad and alpha-numeric display. It employs fan-forced cooling and it is intended for vertical placement.

The front panel display and user controls are intended to be accessible from a comfortable position for and end user (operator), which means that the unit should be installed approximately 3 feet off the floor.

The welder weighs approximately 145 pounds. For physical dimensions, refer to [Figure 4.4 2000IW/IW+ Integrated Welder Dimensional Drawing](#)

Table 5.1 Environmental Specifications

Environmental Concern	Acceptable Range
Humidity	30% to 95%, non-condensing
Ambient Operating Temperature	+5° C to +50° C (41° F to 122° F)
Storage / Shipping Temperature	-25° C to +55° C (-13° F to +131° F); up to +70° C (+158° F) for 24 hours
Operating Altitude	Up to 1000 m
IP Rating	2X

5.1.2 Electrical Requirements

Table 5.2 Electrical Requirements

Power	Current Rating	NEMA Connector
1100 W 100V - 120V	13 Amp Max. @ 100V / 17Amp CB	NEMA 5-15P Plug
1100 W 200V - 240V	6.5 Amp Max. @ 200V / 8 Amp CB	None supplied
2200 W 200V - 240V	14 Amp Max. @ 200V / 17 Amp CB	None supplied
3300 W 200V - 240V	21 Amp Max. @ 200V / 20 Amp CB	None supplied

5.1.3 Pneumatic Requirements

The factory compressed air supply must be "clean (to a 5 micron level), dry and unlubricated" air with a regulated maximum pressure of 100 psig (690 kPa). Depending on your application, the welder requires between 35 to 100 psi. The welder includes an in-line air filter. A quick-disconnect fitting is suggested. Use a lockout device on the air line if required.

CAUTION	General Warning
	<p>Synthetic air compressor lubricants containing Silicone or WD-40 will cause internal actuator damage and failure due to the solvents contained within these types of lubricants.</p>

CAUTION	General Warning
	<p>There should be no substitute for clean, dry air to run the welder. Use of other types of gas could lead to premature degradation of seals. Contact your Branson representative if you have any concerns.</p>

5.1.4 Circuit Descriptions

The Integrated Welder contains the following modules:

- Line Board
- System Control Board
- Ultrasonic Power Module
- DC Power Module
- User I/O

The following sections contain descriptions for each module.

Line Board

The Line Board performs the dual function of providing RFI filtering for the line voltage input to the integrated welder, and controlling the electrical current surge to the ultrasonic Power Supply Module at power up until the inrush current limiter relay engages. The filtering also blocks ultrasonic signals from entering the AC main line.

System Control Board

The System Control Board performs the following functions:

- Responding to start and stop signals
- Responding to alarm and reset signals
- Responding to user input from the front panel
- Activating and monitoring ultrasonics
- Provides information for Front Panel Displays
- Generate alarms
- Control communications

Ultrasonic Power Supply Module

The Ultrasonic Power Supply Module generates ultrasonic energy at the resonant frequency of your Converter-Booster-Horn Stack. The Ultrasonic Power Supply Module contains three main circuits.

- **320VDC Power Supply:** converts AC line voltage to +320VDC for the output power devices
- **Output circuit** – matches the impedance of the output power device to the Converter-Booster-Horn Stack; and provides feedback to the Control circuit
- **Control circuits:** perform the following functions:
 - Provide drive signal to output power device
 - Determine true percentage of ultrasonic power used over a range of amplitudes
 - Allows control of the resonant frequency
 - Control starting amplitude
 - Provide overload protection for the Ultrasonic Power Module
 - Store operating frequency of last weld (frequency memory) and use the stored frequency as a starting point for the next weld
 - Check and update frequency memory on start-up
 - Provide switch-selective starting ramp times (Start)

DC Power Module

The Switching DC Power Module rectifies, filters, and regulates the AC voltages from the Line Transformer into DC voltages for the System Control Module.

5.1.5 Converters and Boosters

The 2000IW/IW+ uses the CJ 20 converter, EDP No. 101-135-059R.

Figure 5.1 CJ 20 Converter

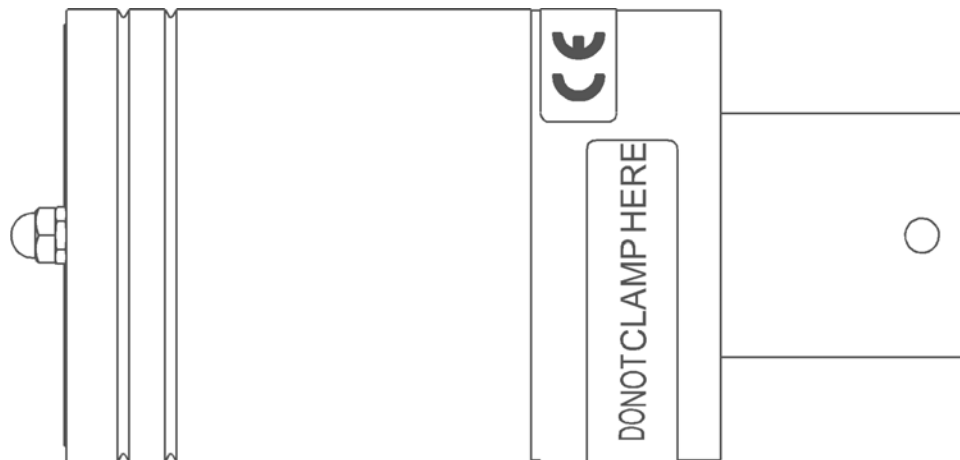

The 2000IW/IW+ uses the boosters listed in the following table

Table 5.3 2000IW/IW+ Boosters

Item	Description	Part Number
Booster	3/8-24 Horn End Drill and Tap 1100 Watt Only	
	Aluminum 1:0.6 (purple)	101-149-090
	Aluminum 1:1 (green)	101-149-093
	Aluminum 1:1.5 (gold)	101-149-092
	Aluminum 1:2 (silver)	101-149-094
	Titanium 1:2.5 (black)	101-149-091
Booster	1/2-20 Horn End Drill and Tap All Models, Preferred	
	Aluminum 1:0.6 (purple)	101-149-055
	Aluminum 1:1 (green)	101-149-051
	Aluminum 1:1.5 (gold)	101-149-052
	Aluminum 1:2 (silver)	101-149-053
	Titanium 1:0.6 (purple)	101-149-060
	Titanium 1:1 (green)	101-149-056
	Titanium 1:1.5 (gold)	101-149-057
	Titanium 1:2 (silver)	101-149-058
	Titanium 1:2.5 (black)	101-149-059
Booster, Solid Mount	1/2 - 20 Input; 1/2 - 20 Output	
	Titanium 1:2.5 (black)	101-149-099
	Titanium 2:1 (silver)	101-149-098
	Titanium 1:1.5 (gold)	101-149-097
	Titanium 1:1 (green)	101-149-096
	Titanium 1:0.6 (purple)	101-149-095

Table 5.4 Other items used with the 2000IW/IW+

Item	Description	P/N
Mylar® Washers (for 20 kHz systems)	Kit, 10 each (1/2 in. or 3/8 in.)	100-063-357
	Kit, 150 each (1/2 in.)	100-063-471
	Kit, 150 each (3/8 in.)	100-063-472
Studs	1/2-20 x 1-1/4 (titanium horns)	100-098-370
	1/2-20 x 1-1/2 (aluminum horns)	100-098-123
	SCREW ALLEN 3/8-24 x 1	100-098-120



Chapter 6: Operation

6.1	Weld Modes	82
6.2	Setting Weld Cycle Parameters	92
6.3	Controlling the Front Panel Display	95
6.4	Setup Procedure	96
6.5	Weld Cycle State Displays and Alarms	100
6.6	Resetting the System	107
6.7	Ultrasonic Test	108
6.8	Horn Down	109
6.9	Converter Cooling	110

6.1 Weld Modes

WARNING	General Warning
	<p>When setting up and operating the welder, observe the following precautions.</p> <ol style="list-style-type: none"> 1. High voltage is present. Do not operate with covers open or removed. 2. To prevent the possibility of electric shock, make sure that the welder is properly grounded. 3. Do not touch a vibrating horn. 4. Large plastic workpieces may vibrate within the audible frequency range when welded. If this occurs, use hearing protectors to prevent possible injury. 5. Do not press the TEST switch or cycle the machine when the converter is removed from the welder. 6. When using larger horns, avoid situations where fingers could be pinched between the horn and the fixture.

CAUTION	General Warning
	<p>Do not allow an ultrasonically activated horn to touch a metal base or a metal fixture.</p>

The 2000IW has one weld mode, Time. The IW+ has three weld modes:

- Time mode - use when cycle time repeatability is critical
- Collapse Distance mode - use where material displacement is important
- Absolute Distance mode - use when final dimensions are critical

6.1.1 Modifying Weld Modes

Weld modes can be modified by setting *parameters* for further control over the weld cycle. You can also set *limits* that you can compare with *actual values* for monitoring and greater weld accuracy. In addition, you can set ultrasonics to start on the trigger switch (TRS) or to be *pretiggered*. You can also adjust the carriage's down speed. Refer to Section [6.1.2 Using Weld Modes](#) for details on how to apply the features.

6.1.1.1 Parameters

Weld modes can be *controlled* from the front panel by adjusting Time, Collapse and Absolute Distance parameters, depending on the selected mode (and if available in your model). Hold Time and the *selectable* Afterburst (AB) Delay parameters can be adjusted from all three welding modes.

NOTICE	
	<p>Note that, while AB Time and AB Delay are selectable, they do not <i>have</i> to be set. The two parameters work in tandem - if AB Time is selected, then AB Delay must also be selected, Afterburst is used to release workpieces that stick to the horn face after welding.</p>

Table 6.1 Parameter Functions

Parameters	Mode	Switch	Function
Weld Time	All	Mode	Sets the amount of time ultrasonic energy is applied to the workpiece. In Collapse or Absolute Distance Modes the weld time parameter acts as a cycle abort condition. Ensure Time is setup to allow for the collapse or absolute distances to be attained during a weld.
Collapse Distance IW+ only	Collapse	Mode	Sets the amount of collapse distance traveled from TRS while ultrasonics were active. Note that the actual collapse includes distance traveled during Hold Time which, depending on your application, may increase the weld collapse distance.
Absolute Distance IW+ only	Absolute	Mode	Sets the amount of absolute distance traveled from ULS while ultrasonics were active. Note that the actual absolute includes distance traveled Hold Time which, depending on your application, may increase or decrease the weld absolute distance.
Hold Time	All modes	HOLD TIME	Sets the amount of time force is applied to the workpiece after ultrasonic energy is turned off, and while the horn is still contacting the workpiece.
AB Time	All modes	AB TIME	If selected, controls the length of time ultrasonic energy is active after AB Delay. Aids in dislodging a workpiece from the horn, if necessary. Used in conjunction with AB Delay.
AB Delay	All modes	AB DELAY	If selected, controls the amount of time between the removal of force from the workpiece and the point at which AB Time starts. Aids in dislodging a workpiece from the horn, if necessary, Required with AB Time.

6.1.1.2 Limits IW+ only

Weld modes can be monitored by setting Time, Collapse, and Absolute Limits (+ and -) from the front panel. When these limits are set, the welder will compare the actual values to your set limits.

Use Time, Collapse and Absolute limits to alert you to variations in your weld cycle.

Table 6.2 Limit Function

Limit	Functions
+ Limit	Selects <i>maximum</i> value for the currently selected mode, either Time or Distance. Can be used to check distance (inches/mm) as well as time (seconds) when welding.
-Limit	Selects <i>minimum</i> value for the currently selected mode, either Time or Distance. Can be used to check distance (inches/mm) as well as time (seconds) when welding.

6.1.1.3 Actual Values IW+ only

Press the ACTUAL switch on the front panel to view actual values. Use actual values to calculate weld cycle measurements for greater accuracy and repeatability, as well as to compare with limits set. Actual values measure as follows:

Actual Time: The time from the trigger switch becoming active until the end of the weld time portion of the cycle.

Actual Collapse: The distance between the trigger switch becoming active to the end of the hold time portion of the cycle, and

Actual Absolute: The distance from the upper limit switch becoming inactive to the end of the hold time portion of the cycle.

6.1.1.4 Pretriggering

In Pretriggering, ultrasonic energy activates on the Upper Limit Switch (ULS) instead of the Trigger Switch (TRS) when DIP switch settings are altered.

Use pretriggering in certain applications such as staking when you need ultrasonics to start (pretrigger) before contacting the workpiece. You can also use pretriggering for large or hard-to-start horns.

Pretriggering ultrasonics at the ULS is generally recommended in staking, insertion and sheer joint welding applications.

Pretrigger Settings

Table 6.3 Pretrigger Settings

DIP Switch	Pretriggering Settings	Result
SW1-1	OFF	Pretrigger OFF
SW1-1	ON	Pretrigger ON Ultrasonics pretrigger when ULS becomes inactive
SW1-3*	OFF	Weld Time starts when TRS becomes active. Ultrasonics start when ULS becomes inactive.
SW1-3*	ON	Weld Time starts when ULS becomes inactive.

* Only valid when SW1-1 is ON

For further information on setting DIP switches, refer to Section [4.11.1 Setting DIP Switches](#) DIP Switches.

6.1.1.5 Down speed adjustment

If necessary alter the carriage's down speed by adjusting the DOWN SPEED control on the front panel. For further details on using this control, see [Figure 2.2 Front Panel Controls, IW](#) Front Panel, callout 3. You can also adjust the Stroke Length as described in Section [4.10 Adjusting Welder Height and Aligning the Horn](#).

6.1.2 Using Weld Modes

The following sections describe how to use weld modes with their associated parameters.

6.1.2.1 Time Mode

Use Time mode when consistency of welder cycle time is an important part of your operation. For example, use in automated systems where the welder cycle time must be limited to maintain overall system speed.

For IW+ only, in Time mode, the Time + and - Limits are active. The Collapse and Absolute + Limits act as safeties. If reached, they will override the controlling parameter and terminate Weld time. Use limits to monitor the weld cycle, by comparing actual values to the set limits.

Figure 6.1 Time Mode, IW+ only

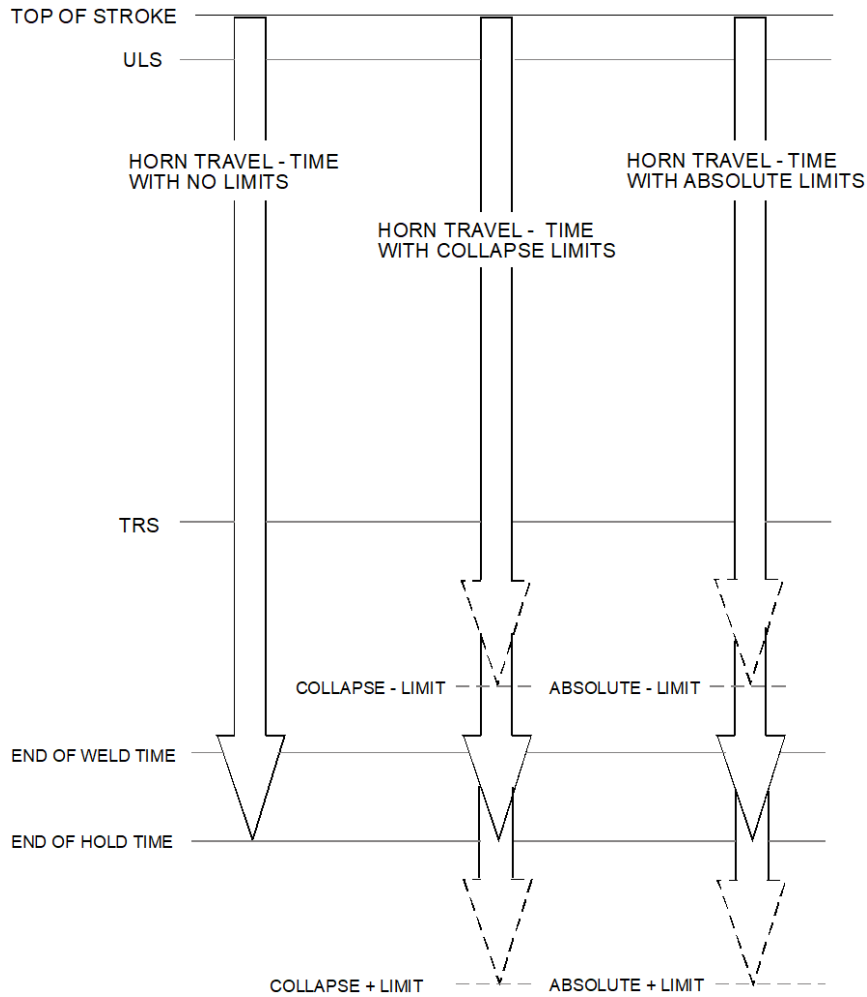



Table 6.4 Time Mode Parameters, IW+ only

Parameter	Control and/or Monitor	Can be Disabled	Safety Limits	Alarm
Weld Time	Controls	No	No	No
Hold Time	Controls	No	No	No
AB Delay	Controls	Yes	No	No
AB Time	Controls	Yes	No	No
Time				
+ Limit	Monitors	Yes	Yes	Yes
- Limit	Monitors	Yes	Yes	Yes
Collapse				
+ Limit	Monitors	Yes	Yes	Yes
- Limit	Monitors	Yes	No	Yes
Absolute				

Table 6.4 Time Mode Parameters, IW+ only

Parameter	Control and/ or Monitor	Can be Disabled	Safety Limits	Alarm
+ Limit	Monitors	Yes	Yes	Yes
- Limit	Monitors	Yes	No	Yes

NOTICE	
	Safety limits, if reached, will terminate Weld Time.

6.1.2.2 Collapse Distance Mode, IW+ only

Use Collapse Distance mode to control material displacement. For example, when sealing around a filter border, and you need a hermetic seal.

Collapse Distance mode can be set with Time and both Collapse or Absolute limits.

NOTICE	
	In Collapse or Absolute Distance Modes the weld time parameter acts as an overriding condition. Ensure Time is setup to allow for the collapse or absolute distances to be attained during a weld.

Collapse Distance Mode, IW+ only

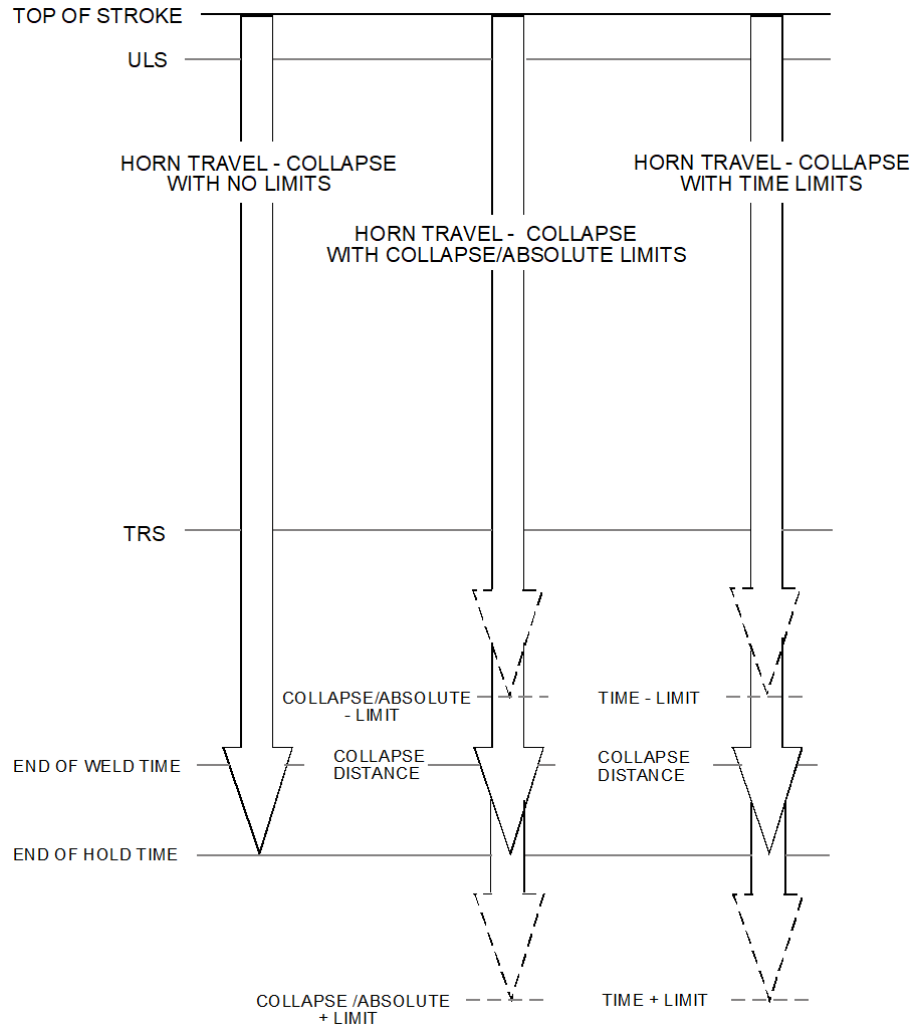



Table 6.5 Collapse Distance Mode Parameters, IW+ only

Parameter	Control and/or Monitor	Can be Disabled	Safety Limit	Alarm
Collapse Distance	Controls	No	No	No
Hold Time	Controls	No	No	No
AB Delay	Controls	Yes	No	No
AB Time	Controls	Yes	No	No
Time				
+ Limit	Monitors	Yes	Yes	Yes
- Limit	Monitors	Yes	No	Yes
Collapse				
+ Limit	Monitors	Yes	Yes	Yes
- Limit	Monitors	Yes	No	Yes

Table 6.5 Collapse Distance Mode Parameters, IW+ only

Parameter	Control and/or Monitor	Can be Disabled	Safety Limit	Alarm
Absolute				
+ Limit	Monitors	Yes	Yes	Yes
- Limit	Monitors	Yes	No	Yes

NOTICE	
	Safety limits, if reached will terminate Weld Time.

6.1.2.3 Absolute Distance Mode, IW+ only

Use Absolute Distance Mode when the final workpiece height is crucial for your application. For example, when welding a film canister that must fit snugly into a camera body. Use this mode when dimensional consistency of the final workpiece is critical, or to monitor suspect parts.

Absolute Distance mode can be set with Time and Absolute or Collapse Distance limits. The following figure illustrates weld cycles in Absolute Distance mode with different limit settings.

NOTICE	
	In Collapse or Absolute Distance Modes the weld time parameter acts as an overriding condition. Ensure Time is setup to allow for the collapse or absolute distances to be attained during a weld.

Figure 6.2 Absolute Distance Mode, IW+ only

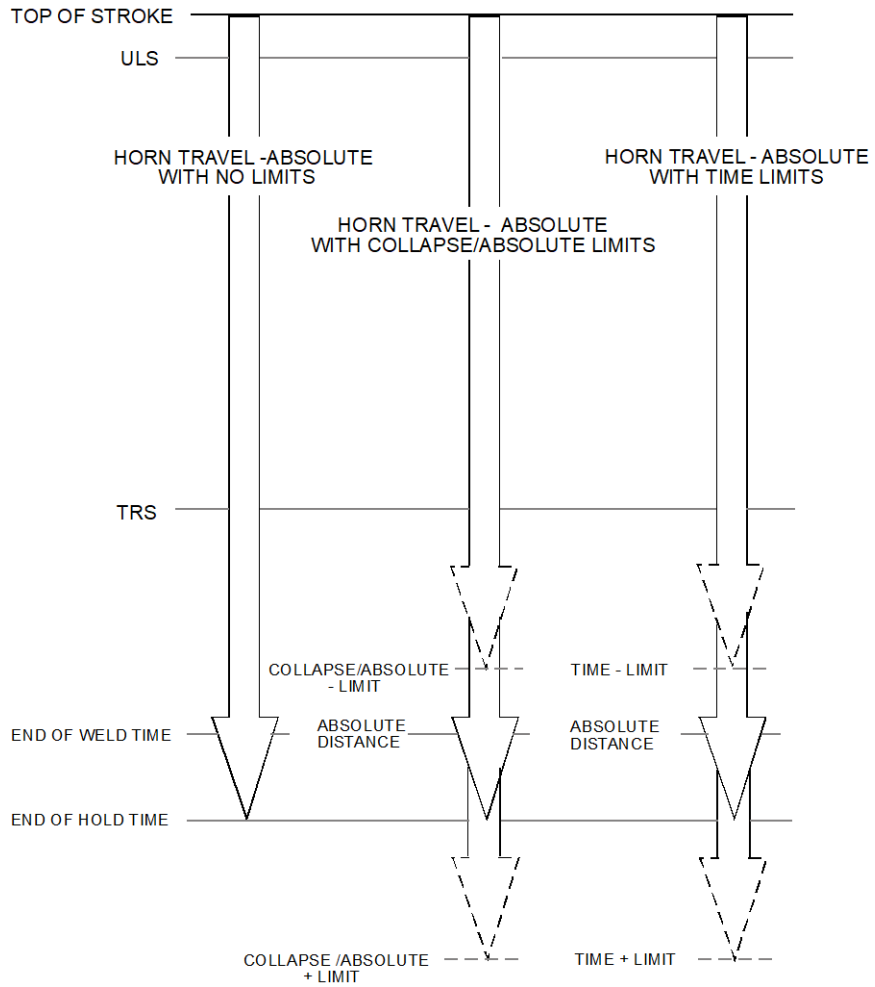



Table 6.6 Absolute Distance Mode Parameters, IW+ only

Parameter	Control and/or Monitor	Can be Disabled	Safety Limits	Alarm
Absolute Distance	Controls	No	No	No
Hold Time	Controls	No	No	No
AB Delay	Controls	Yes	No	No
AB Time	Controls	Yes	No	No
Time				
+ Limit	Monitors	Yes	Yes	Yes
- Limit	Monitors	Yes	No	Yes
Collapse				
+ Limit	Monitors	Yes	Yes	Yes
- Limit	Monitors	Yes	No	Yes

Table 6.6 Absolute Distance Mode Parameters, IW+ only

Parameter	Control and/or Monitor	Can be Disabled	Safety Limits	Alarm
Absolute				
+ Limit	Monitors	Yes	Yes	Yes
- Limit	Monitors	Yes	No	Yes

NOTICE	
	Safety limits, if reached, will terminate Weld Time.

6.2 Setting Weld Cycle Parameters

When the welder is in the READY state, set parameters by pressing the appropriate switches on the front panel. Once set, to store the current parameters, press one or both START SWITCHES, or press RESET.

If you set parameters, start a weld cycle, then hit the EMERGENCY STOP before ending the cycle, the parameters will be lost.

6.2.1 Selecting a Parameter to Modify

After selecting your weld mode by pressing MODE, press the appropriate switch for the parameter you wish to modify. For example, press MODE for the Time, Collapse or Absolute parameters, press HOLD TIME for the Hold Time parameter, then press the appropriate LIMIT switch to set limits, if necessary.

As you press a switch, its LED will light and the selected parameter's value will be displayed in the NUMERIC display.

6.2.2 Modifying Parameter Values

Press the UP/DOWN switches until the value you wish to modify is displayed in the LED display. Effects of pressing these switches are illustrated in the following Table. In the Increment Values column, the left side figures indicate effects of pressing SLOW UP/DOWN switches, while the right side figures indicate effects of pressing FAST UP/DOWN switches.

If you press an UP/DOWN switch after pressing a parameter selection switch except MODE, the next press of the parameter selection switch will set the parameter you selected to its original value. Then the next press will set the parameter to its minimum value.

Note that you can recall a parameter after you have changed it, but only either before a weld cycle is run, or before you select another parameter to modify. (For further information, refer to Section [6.2.4 Recalling Stored Parameters](#).)

Table 6.7 Weld Parameter Values IW+ only

Parameter	Range Min	Range Max	Increment Values SLOW/FAST	Units	Can be Disabled	Can be Recalled
Weld Time	.050	10.0	.001/.100	sec	No	No
+ Limit	.050	10.0	.001/.100	sec	Yes	Yes
- Limit	.050	10.0	.001/.100	sec	Yes	Yes
Hold Time	.050	10.0	.001/.100	sec	No	Yes
AB Delay	.050	5.00	.001/.100	sec	Yes	Yes
AB Time	.050	1.00	.001/.100	sec	Yes	Yes
Collapse	.0001	0.25	.0001/.0100	inch*	No	No
+ Limit	.0001	0.25	.0001/.0100	inch*	Yes	Yes
- Limit	.0001	0.25	.0001/.0100	inch*	Yes	Yes
Absolute	.0001	4.00	.0001/.0100	inch*	No	No
+ Limit	.0001	4.00	.0001/.0100	inch*	Yes	Yes

Table 6.7 Weld Parameter Values IW+ only

Parameter	Range Min	Range Max	Increment Values SLOW/FAST	Units	Can be Disabled	Can be Recalled
- Limit	.0001	4.00	.0001/.0100	inch*	Yes	Yes

* If you have selected SI units for your application, these values will be in equivalent millimeters.

6.2.3 Storing Parameters

After parameters have been modified, they are stored. Once one or both START SWITCHES are pressed, then released and the welder enters the READY state, the parameters are stored. However, if you press the EMERGENCY STOP, or turn the welder OFF before it enters the READY state, the updated parameters will be lost and the values previously stored will become the current parameter values.

6.2.4 Recalling Stored Parameters

6.2.4.1 Recalling pre-defined parameter values

To recall predefined parameters, as opposed to setting your own exact setting, sit in front of the welder and press the switch of the parameter (not MODE) that you are modifying as follows:

- Press *two times* consecutively to set the parameter to the minimum value that may be used for that parameter
- Press *three times* to set the parameter to 25% of full scale for that parameter, (This option is not available for weld time, collapse or absolute distance.)
- Press *four times* to disable the parameter (if the parameter can be disabled) or to set the parameter to its minimum value, if it cannot be disabled
- Press *five times* to set the parameter to its minimum value, if the parameter *can* be disabled

These shortcuts are used to “speed up” navigation of numeric parameters.

Table 6.8 Recalling Pre-defined Parameter Values

Parameter	Press 1 time	Press 2 times	Press 3 times	Press 4 times	Press 5 times
Hold Time	Select	Min.	25%	Press 2	Not used
AB Time/Delay	Select	Min.	25%	Disable	Press 2
Limits (\pm)	Select	Min.	25%	Disable	Press 2

Select = Activate parameter for modification

Min. = Set parameter to its minimum value

25% = Set parameter to 25% of full scale

Disable = Disable the function controlled by this parameter. If the function is disabled, the word OFF will be displayed

6.2.4.2 Recalling modified parameter values

When you select a parameter to modify, its value is stored temporarily in an internal register. If, after pressing an UP/DOWN switch, you wish to return to the value you

selected initially (before pressing an UP/DOWN switch), simply press the parameter key once more and the original value will be restored from the internal register. This option is not available for Weld Time, or Absolute or Collapse distance values.

6.2.4.3 Recalling cold start parameter values

If you wish to return to the cold start (factory-set) parameters: as the welder is powered, immediately after activating the welder, simultaneously press and hold the FAST UP and the FAST DOWN switches. Hold until the welder displays "coldstrt" (IW+) or "rdy" (IW), until the mode is changed or until the welder is recycled.

NOTICE	
	If a parameter can be disabled, the cold start operation will disable it. If a parameter cannot be disabled, the cold start operation will set the parameter to its minimum value. You can recall cold start parameters even if the display is locked.

6.3 Controlling the Front Panel Display

The welder has three DIP switch settings for controlling the front panel display:

- Weld Scale Multiplier
- Test Scale Multiplier
- Display Lock

The multiplier settings may be used in low power situations, where the load is less than 50%.

Use Display Lock when you do not want operators to change settings. However you can restore cold start parameter values with this setting. For further information on setting these DIP switches, refer to Section [4.11.1 Setting DIP Switches](#).

If these measures do not resolve your problem, contact your local representative or Branson's Product Support Department.

6.4 Setup Procedure

In either Time or Distance modes, pressing both START SWITCHES within 100 to 200 ms of each other starts a weld cycle. Ultrasonic energy starts and you may release the START SWITCHES when trigger conditions are met, It remains on until the weld parameters are met or until a general alarm or EMERGENCY STOP occurs.

NOTICE	
	<p><i>Push</i> the E-STOP button to terminate the cycle at any time. This causes the carriage to retract and ultrasonic energy to shut off. Twist the E-STOP button to return the welder to READY.</p>

1. If your application has been analyzed in the Branson Application Laboratory, consult the Branson Lab Report for appropriate settings. Otherwise, start with the following welder settings:
 - Mode - Time
 - Weld Time - 500 ms
 - Hold Time - 100 ms
 - Air Pressure - 25 psig/140kPa
 - Trigger Pressure - 1 - 5
 - Down Speed - 3 turns (Yellow)
 - Afterburst Time/Delay - OFF
 - Stroke Length - 1/4 to 3 - 3/4 in/6.35 to 95.25mm

NOTICE	
	<p>Trigger Pressure: Lower trigger pressure settings are generally used unless there is a need to overcome warpage or to compress internal components such as springs, diaphragms or seals.</p>

NOTICE	
	<p>Down Speed: If the DOWN SPEED control is turned OFF (fully clockwise), the carriage will not descend. As an initial setting, turn the control until the yellow ring or yellow and blue rings are visible through the opening on the knob.</p>

2. Adjust the mechanical stop (for further information, see [Figure 4.23 Adjusting the Mechanical Stop](#)).
3. Ensure that the welder is in READY mode.
4. With a workpiece in place, press both START SWITCHES simultaneously or activate the start mechanism. The weld cycle will start, as follows:
 - a The horn advances and contacts the workpiece.

- b Pressure develops between the horn and the workpiece, activating the TRS.
 - c Weld Time begins and you can release the START SWITCHES. Ultrasonic vibrations are activated, The POWER BARGRAPH indicates loading (usually in the 20% - 100% range).
 - d Weld Time ends and ultrasonic energy stops.
 - e The horn continues to clamp the workpiece for the Hold Time selected.
 - f After Hold Time ends, the horn retracts automatically and the workpiece can be removed from the fixture.
5. Weld a few workpieces using the initial parameters and check for desired properties.

You may not obtain optimum results initially, but, based on the quality of the weld obtained and the POWER BARGRAPH reading, you can alter settings or adjust switches to achieve satisfactory results. Change one setting at a time until a weld is produced in minimum time with maximum strength.

The following Figures illustrate Weld Setup and Operation for Time Mode and Collapse/Absolute Distance Modes.

Figure 6.3 Setup and Operation in Time Mode

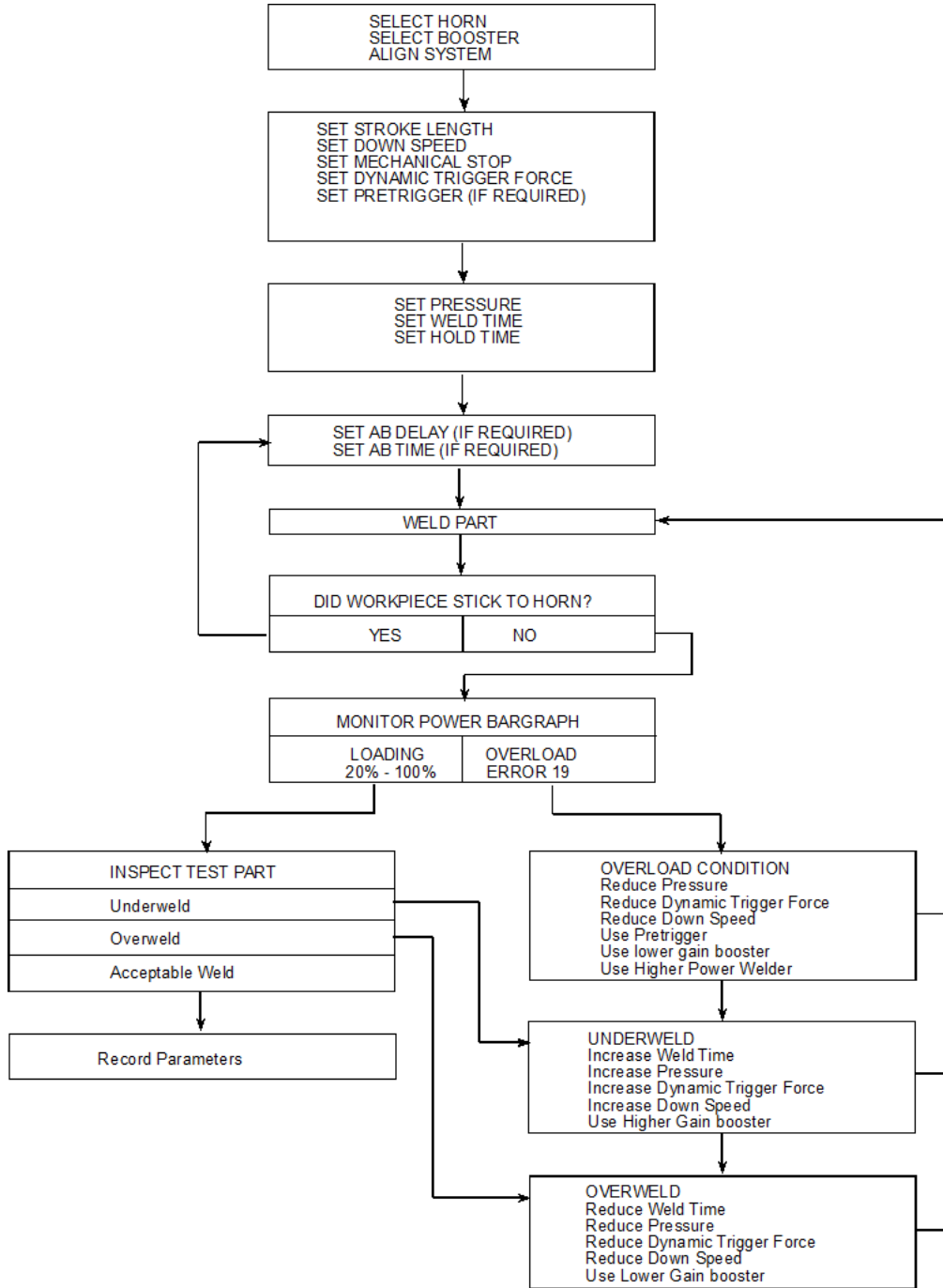
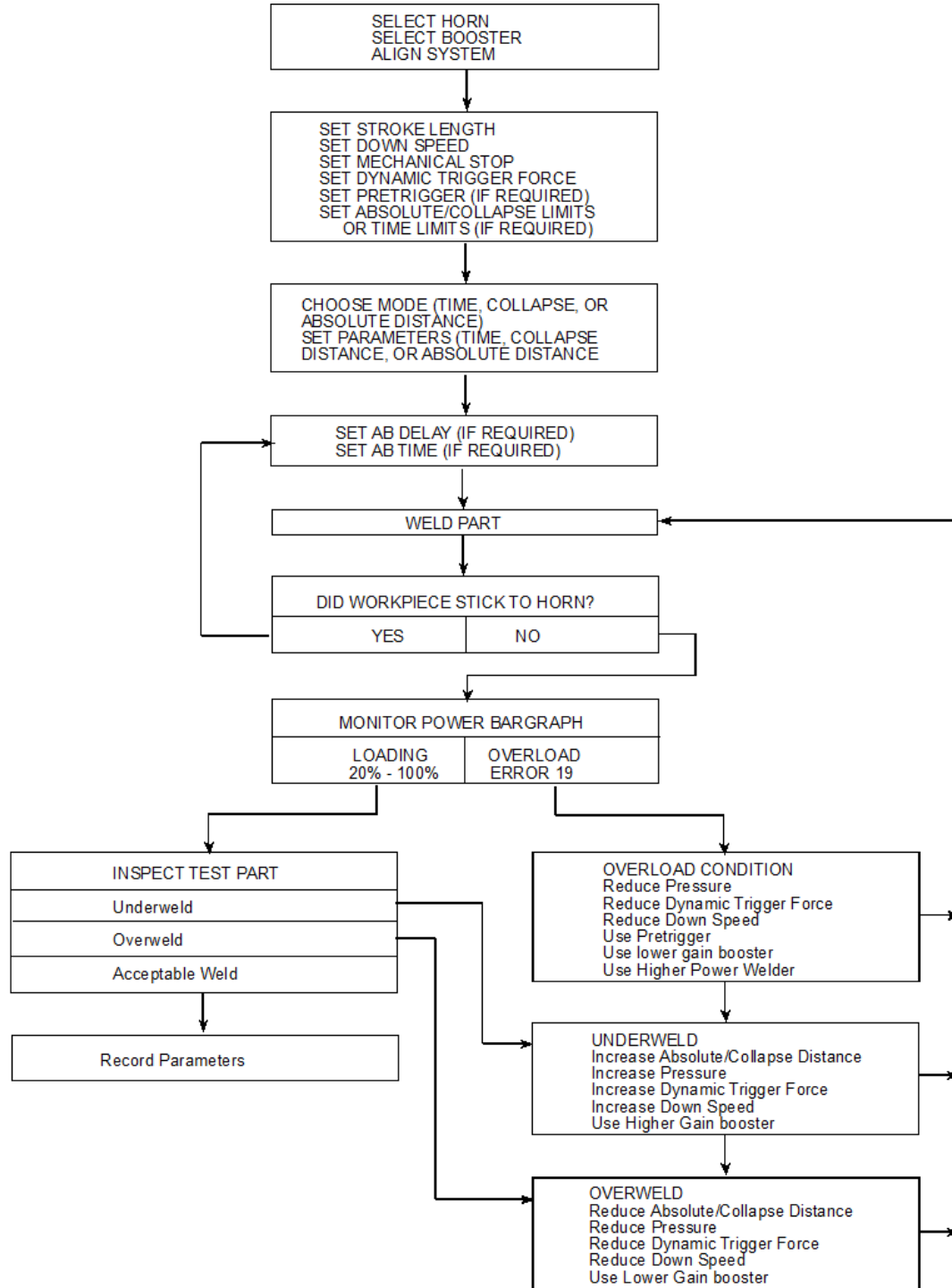

Figure 6.4 Setup and Operation in Collapse /Absolute Distance Modes



6.5 Weld Cycle State Displays and Alarms

When the welder is turned on, it performs a number of internal system tests. If any errors are encountered, the welder will not enter the READY state. If no errors are encountered, the welding parameters are set to those stored. An error in reading the settings will cause cold values to be used.

Upon successful completion of the internal tests, the welder enters the READY state and you will see READY displayed on the numeric display. At this point, you can set weld cycle parameters (as described in Section [6.2 Setting Weld Cycle Parameters](#)).

If the welder does not successfully complete the internal tests and you receive an error message, refer to Section [6.5.1.1 Weld Cycle Alarms and Error Messages](#) for a definition of the message.

6.5.1 Weld Cycle State Displays

During a normal weld cycle, the eight-digit NUMERIC DISPLAY shows the current weld cycle state as indicated below.

Table 6.9 2000IW State Displays

State	Description
S0	One START SWITCH Pressed/Wait for Second START SWITCH - The currently active welding parameters are stored in NOVRAM (non-volatile memory) and a 100 to 200 ms stagger timer is started, during which time the other START SWITCH must be pressed or an alarm will be generated and the welder will return to READY state.
S1	Both START SWITCHES Pressed/Wait for SV (Solenoid Valve) Active - When both START SWITCHES have been pressed within 100 to 200 ms of each other, the SV circuit is activated and a 4 sec. timer is started, during which time the SV signal must become active or an alarm will be generated and the weld cycle aborted.
S2	SV Active/Wait for ULS - When the SV signal is activated within the timeout period, a 4 sec. timer is started, during which time the ULS signal must become inactive or an alarm will be generated and the SV signal deactivated. In addition, if either START SWITCH input is lost (where the START SWITCH input status is defined as "Maintained"), an alarm will be generated and the SV signal deactivated.

Table 6.9 2000IW State Displays

State	Description
S4	<p>ULS Inactive/Wait for TRS - When the ULS signal becomes inactive within the timeout period, a 4 sec. timer is started, during which time the TRS signal must become active or an alarm will be generated and the SV signal deactivated.</p> <p>In addition, if either the ULS or LLS signals become active, or one of the START SWITCH inputs is lost (where the START SWITCH input status is defined as "Maintained"). an alarm will be generated and the SV signal deactivated.</p> <p>Once the TRS signal becomes active, the weld parameters established for Weld Time, Hold Time, AB Delay and AB Time are applied. Ultrasonic energy will remain on until the specified Weld Time has elapsed, the LLS signal becomes active (if the LLS function has been enabled), and overload occurs, or the TRS input is lost.</p> <p>Following successful completion of Weld Time, the SV drive circuit will remain active for the duration of the specified Hold Time (unless TRS input is lost). If specified, the parameters for AB Delay and AB Time are applied following successful completion of the Hold Time.</p>
S5	Wait for TRS Inactive - once the weld parameters have been met, a 4 sec. end-of-sequence timer is started, during which time the TRS input must become inactive or an alarm will be generated.
S7	Wait for ULS Active - During the 4 sec. end-of-sequence timer, the ULS input must become active or an alarm will be generated.
S8	Wait for START SWITCHES - During the 4 sec. end-of-sequence timer, the START SWITCH inputs must be released or an alarm will be generated.

Table 6.10 2000IW+ State Displays

State	Description
S0	Ready State stores the current welding parameters into the NOVRAM.
S1 or S2	One START SWITCH Pressed starts a 200 ms stagger time, during which time the other START SWITCH must be pressed. If the second START SWITCH is not pressed within 200 ms, an error will be generated and the welder will return to the READY state.
S3	SV Drive Active/Wait for ULS. If the ULS signal does not become inactive within the 4 sec. timeout period, or a START SWITCH input is lost, the SV drive circuits will be deactivated, and an error display will be generated.
S5	<p>ULS Inactive/Wait for TRS. If the ULS signal becomes inactive within the 4 sec. timeout period, or the pretrigger source has become active within the 4 sec. pretrigger wait time, a 4 sec. timeout period will start.</p> <p>If the TRS signal does not become active during its timeout period, the ULS input becomes active, or one of the START SWITCH inputs is lost, the SV drive circuits will be deactivated and an error display will be generated.</p>

Table 6.10 2000IW+ State Displays

State	Description
S6	Weld (Ultrasonics Active) applies ultrasonics until the weld parameter conditions have been met, or any enabled plus limit is reached, or the overload input from the SPM becomes active, or the TRS input and one of the START SWITCH inputs are lost.
S12	Hold Time deactivates ultrasonics. Remains active for the required amount of time, or until TRS input is lost.
S13	AB Delay deactivates the SV drive circuits and waits for the AB Time to expire (0 ms if disabled).
S14	AB Time activates ultrasonics for the specified amount of AB time (0 ms if disabled). The AB duration time (length of time ultrasonics is ON) defaults to 0 ms if the AB Delay parameter is disabled.
S7	Wait for TRS Inactive activates a 4 sec. end-of-sequence timer and waits for the TRS input to become inactive. If the TRS input does not become inactive within the 4 seconds, an error is generated and the display error state is initiated.
S8 or S9	Wait for ULS Active if the ULS input does not become active during the 4 sec. end-of-sequence state, an alarm is generated and the display error state is initiated.
S10	Wait for START SWITCHES Inactive During the 4 sec. end-of-sequence timer, the START SWITCH inputs must be released or an alarm is generated and the display error state is initiated.
S11	Display Errors/Return to Ready the final state of a weld cycle. In this state all alarms that occurred during the cycle will be displayed in turn on the NUMERIC DISPLAY.

If the alarm latch feature is activated and there are *latchable* alarms, then you must press RESET before the welder will return to the READY state.

However, if there are *latching* alarms, or *hardware* alarms, the READY state will not be reached. For further information on alarms and error messages refer to the following Sections: [6.5.1.1 Weld Cycle Alarms and Error Messages](#), and [6.5.2 Clearing Weld Cycle Alarms](#).

Once the alarms have been cleared, or if no errors were detected, the welder returns to the READY state.

6.5.1.1 Weld Cycle Alarms and Error Messages

Once a weld cycle ends, the NUMERIC DISPLAY shows in an error code format any error messages generated. In addition, error messages are displayed whenever a parameter selection switch is pressed while there are active alarms. (For further information, refer to Section [6.5.2 Clearing Weld Cycle Alarms](#).)

There are four types of alarms. Responses are described below:

- *Non-Resettable* - power the welder OFF and then back ON to clear this alarm. Used for hardware failures
- *Latching* - press RESET before the next weld cycle can start
- *Non-Latching* - once the condition that caused the alarm is clear, the alarm message will no longer be displayed, A weld cycle can run as soon as this clears

- *Latchable* - based on the setting of the Alarm Latch Enable DIP switch. If the DIP switch is OFF, this group of alarms will become non-latching alarms. If the DIP switch is ON, this group of alarms will become latching alarms. (For further information, refer to Section [4.11.1 Setting DIP Switches.](#))

Table 6.11 Error Codes

Error Code	IW	IW+	Description
Error 01	x	x	ULS Ready Error <i>Latchable</i> - The ULS input was not active while the welder was in the READY state. Activated at the end of an aborted cycle.
Error 03	x	x	TRS Ready Error <i>Latchable</i> - The TRS input was active while the welder was in the READY state, or trying to enter the READY state.
Error 04	x		LLS Ready <i>Latchable</i> - The LLS input was active while the welder was in the READY state.
Error 05	x		SV Ready <i>Non-Resettable</i> - The SV drive input indicates that the output was active while the welder was in the READY state. This often indicates a blown fuse.
Error 06	x	x	ULS Enter <i>Non-Latching</i> - The ULS input did not become inactive within 4 sec. of SV drive activation and remained active until weld timing began.
Error 08	x	x	TRS Enter Error <i>Non-Latching</i> - The TRS input did not become active within 4 sec. of ULS becoming inactive.
Error 09	x		LLS Enter <i>Non-Latching</i> - The LLS input became active before weld timing began.
Error 10	x		PBS Enter <i>Non-Latching</i> - The START SWITCHES were not pressed within 100 to 200 ms of each other, or the START SWITCH inputs were lost before the TRS input became active and before weld timing began.
Error 11	x	x	ULS Exit <i>Non-Latching</i> - The ULS input did not become active within 4 seconds of SV drive deactivation (time after TRS has become inactive).
Error 12		x	PTS Exit Error <i>Latchable</i> - The ULS did not become inactive within allowed time in pretrigger mode.
Error 13	x	x	TRS Exit Error <i>Non-Latching</i> - The TRS input did not become inactive within 4 seconds of SV drive deactivation (allowed time).
Error 14	x	x	PBS Exit Error <i>Non-Latching</i> - The PB inputs did not become inactive within 4 seconds of SV drive deactivation, or were still active after power-up or after E-STOP inputs have been deactivated (within 4 seconds of the ULS becoming inactive).
Error 15	x	x	TRS Weld Error <i>Latchable</i> - The TRS input became inactive during weld or hold timing (before the ULS became inactive).

Table 6.11 Error Codes

Error Code	IW	IW+	Description
Error 16	x		ULS Lost Waiting for TRS <i>Latchable</i> - After the ULS input became inactive, the ULS input became active again before the TRS input became active.
Error 17	x		LLS Function <i>Latchable</i> - The LLS input met the conditions for an LLS error as defined by the LLS control DIP switches. For further information, refer to 4.11.1 Setting DIP Switches Selecting DIP Switches.
Error 18	x		Power Supply Module Startup Overload <i>Latchable</i> - The SPM/AT (System Protection Monitor) indicated a power supply overload within the first 50 ms of operation.
Error 19	x	x	Power Supply Module Overload Error <i>Latchable</i> - The AUPS indicated a power supply module overload within the first 60 ms of operation.
Error 20	x		NOVRAM Data <i>Latchable</i> - The data read from non-volatile memory did not pass a data integrity check. If the power supply cannot read the parameter settings stored in NOVRAM at power-up, the factory-set settings are used.
Error 21	x	x	SV Active Error <i>Non-Resettable</i> - The SV drive output did not meet the requirements for activating the SV. This error cannot be cleared by RESET, or by the external RESET input.
Error 23	x		ULS Lost Waiting for TRS <i>Latchable</i> - After the ULS input became inactive, the ULS input became active again before the PTS input became active (PTS enabled).
Error 24	x		PTS Lost Waiting for TRS <i>Latchable</i> - After the PTS input became active, the PTS input became inactive again before the TRS input became active.
Error 25		x	SV Deactive Error <i>Non-Resettable</i> - The SV drive output did not meet the requirements for deactivating the solenoid valve. This error cannot be cleared by RESET, or by the external RESET input.
Error 26		x	START SWITCH 2 Lost <i>Non-Latching</i> - START SWITCH 2 was lost before the trigger became active.
Error 27		x	SV Safety Error <i>Non-Resettable</i> - SV drive safety circuit is not working. This error cannot be cleared by RESET, or by the external RESET input.
Error 28		x	START SWITCH 2 Stagger Error <i>Non-Latching</i> - START SWITCH 2 was not pressed within 200 ms after START SWITCH 1 was pressed.
Error 29		x	START SWITCH 1 Stagger Error <i>Non-Latching</i> - START SWITCH 1 was not pressed within 200 ms after START SWITCH 2 was pressed.
Error 30		x	Time Limit Error <i>Latchable</i> - Minus time limit not reached.

Table 6.11 Error Codes

Error Code	IW	IW+	Description
Error 31		x	Collapse Limit Error <i>Latchable</i> - Plus collapse limit exceeded or minus collapse limit not reached.
Error 32		x	Absolute Limit Error <i>Latchable</i> - Plus absolute limit exceeded or minus absolute limit not reached, or weld aborted because of overload.
Error 33		x	Time Limit Setup Error <i>Latchable</i> - Value for minus limit greater than value for plus limit, or minus limit greater than nominal value, or plus limit less than the nominal value.
Error 34		x	Collapse Limited Setup Error <i>Latchable</i> - Value for minus limit greater than value for plus limit, or plus limit less than nominal value.
Error 35		x	Absolute Limit Setup Error <i>Latchable</i> - Value for minus limit greater than value for plus limit, or plus limit less than nominal value.
Error 37		x	TRS Lost Error <i>Latchable</i> - TRS was lost during weld time, hold time, or horn down.
Error 38		x	ULS Weld Error <i>Latchable</i> - ULS was active during weld time or during hold time.
Error 39		x	ULS Active Error <i>Latchable</i> - ULS became active while waiting for the TRS after the ULS was already inactive.
Error 40		x	START SWITCH 1 Lost Error <i>Non-Latching</i> - START SWITCH 1 was lost before the trigger became active.

6.5.2 Clearing Weld Cycle Alarms

NOTICE	
	All alarms must be cleared before any weld parameters can be modified.

Alarms occur when:

- the welder overloads;
- trigger is lost;
- hardware fails; or
- monitored parameters are not within limits

The procedure used to reset the system after an alarm condition is generated depends on the type of alarm. Alarms are classified as either Latchable (Latching or Non-Latching) or Non-Resettable.

The Alarm Latch DIP switch setting determines whether Latchable alarms are Latching or Non-Latching. Use Switch 1, 5 Alarm Latch Status:

- ON = Alarm Latch Enabled Latching
- OFF = Alarm Latch Disabled Non-Latching

For further information on setting DIP switches, refer to Section [4.11.1 Setting DIP Switches](#).

6.5.2.1 Latchable alarms

Latching alarms prevent a new weld cycle from starting and can only be cleared by pressing RESET or activating the EXTERNAL RESET signal.

NOTICE	
	The reset circuitry requires 30 ms to clear an alarm before cycling, therefore if RESET is pressed for less than 30 ms, the welder will not return to the ready state.

Non-Latching alarms are displayed on the front panel and generate output signals through the accessory interface. All non-Latching alarms are cleared when the next cycle is started (by START SWITCH or start cable) or they will clear themselves after 1.5 seconds.

6.5.2.2 Non-Resettable alarms

Non-Resettable alarms prevent the welder from cycling. They are caused by hardware failure. You must turn the welder OFF, correct the situation and then turn the welder back on before you can start the next weld cycle. These alarms cannot be cleared by pressing RESET or the EXTERNAL RESET signal.

6.6 Resetting the System

During powerup, you can restore the weld parameters to their Cold Start (factory-set) values. Follow the step for your welder below.

- *For the IW+ welders*, Press both the FAST UP and FAST DOWN switches until the welder displays "coldstart" and goes to Time mode
- *For the IW welders*, Press both the FAST UP and FAST DOWN switches until the welder displays "RDY" and goes to Time mode

This will set Weld and Hold Time to 50 ms (the minimum value) and disable AB Delay, AB Time and all limits. This procedure also functions if you have activated Display Lock.

6.7 Ultrasonic Test

Use the TEST switch on the front panel to measure the ultrasonic energy dissipated by the stack in air, as long as the welder does not overload. When a welder is operating correctly, the power dissipated by one specific stack in air should be consistent (\pm) over a long period of time. Any change in power indicates that a problem could be developing.

If an overload occurs, and the stack is known to be mechanically sound, the welder may require manual tuning. (For further information, refer to Section [7.4.1 Manual Tuning](#).)

To test the welder, make sure that the stack is properly assembled and that all connections have been made correctly. Then press TEST.

CAUTION	General Warning
	<p>You must have a converter-booster-horn stack installed in you welder before activating ultrasonic energy.</p>

WARNING	General Warning
	<p>Ensure that the cover is closed with the door screws secured and that no one is in contact with the horn when you press TEST. Automated systems users should turn off indexing equipment for this test.</p>

Ultrasonic energy will remain on as long as TEST remains pressed and the welder does not overload. Pressing TEST causes the POWER BARGRAPH to switch to the DIP Switch-selected multiplier (for further information, refer to Section [4.11.1 Setting DIP Switches](#)). After 4 to 6 seconds, the Autotune feature is disabled and the welder enters manual tuning mode (for further information, refer to Section [7.4.1 Manual Tuning](#)). From this point on, tuning is controlled by the tuning potentiometer.

6.8 Horn Down

Use the following procedure to check you horn-to-fixture alignment and/or Mechanical Stop Setting:

1. Press HORN DOWN
2. Press the START SWITCHES simultaneously and hold until the TRS is active (indicated by a single beep). At this point you may release the START SWITCHES
3. To enter READY state and retract the horn, press HORN DOWN again

While you are in HORN DOWN, the NUMERIC DISPLAY will indicate horn travel.

6.9 Converter Cooling

The standard converter cooling method used on Branson integrated welders is to direct the exhaust air from the cylinder, through the converter.

Converter performance and reliability can be adversely affected if subjected to temperatures in excess of 140° F / 60° C. The converter front driver temperature should not exceed 122° F / 50° C.

NOTICE	
	Additional heat will be generated if the converter-booster-horn interfaces need reconditioning, Be sure the stack is in good condition and properly assembled.

Check if your converter is operating at too high a temperature immediately after substantial welder operation and without ultrasonics applied to the horn. To check the temperature, tape a pyrometer or similar temperature measuring device onto the front drive (nose piece) of the converter assembly.

Wait for the device to reach the temperature of the driver. If this temperature is 120° F / 48° C or higher, your equipment requires additional cooling. Contact Branson for further assistance.

Chapter 7: Maintenance

7.1	IW/IW+ Preventive Maintenance	112
7.2	Parts Lists	116
7.3	Circuits	117
7.4	Troubleshooting	118

7.1 IW/IW+ Preventive Maintenance

WARNING	General Warning
	<p>Use LOTO (Lock Out Tag Out) lockable plug cover over line cord plug during any maintenance.</p>

The following preventive measures help assure long term operation of your Branson 2000 Series equipment.

7.1.1 Periodic Maintenance Procedures

Periodic maintenance for the welder involves:

- Inspecting the mating surfaces of the Converter-Booster-Horn Stack. If these surfaces become corroded, recondition the surfaces by following the instructions in the following Section
- Inspecting and cleaning Air Filter components
- External covers may be cleaned with a damp sponge or cloth using a solution of mild soap and water. Do not allow cleaning solution to enter the unit

7.1.2 Reconditioning the Stack (Converter, Booster and Horn)

Welding system components work most efficiently when the Converter-Booster-Horn Stack mating surfaces are flat, in solid contact, and free from fretting corrosion. Poor contact between mating surfaces wastes power output, makes tuning difficult, increases noise and heat, and may cause damage to the converter.

For standard 20 kHz products, a Branson Mylar® washer should be installed between the horn and booster, and horn and converter. Replace the washer if torn or perforated. Stacks using Mylar washers should be inspected every three months.

CAUTION	General Warning
	<p>Never clean the Converter-Booster-Horn Stack mating surfaces by using a buffing wheel or by filing.</p>

WARNING	General Warning
	<p>When performing maintenance on the welder, make sure that no other automated systems are active.</p>

7.1.2.1 Stack Reconditioning Procedure

To recondition stack mating surfaces, take the following steps:

Table 7.1 Stack Reconditioning Procedure

Step	Action
1	Disassemble the Converter-Booster-Horn Stack and wipe the mating surfaces with a clean cloth or paper towel.
2	Examine all mating surfaces. If any mating surface shows corrosion or a hard, dark deposit, recondition it.
3	If necessary, remove the threaded stud from the part.
4	Tape a clean sheet of #400 (or finer) grit emery cloth to a clean, smooth, flat surface (such as a sheet of plate glass), as in Figure 7.1 Reconditioning Stack Surfaces .
5	Place the interface surface on the emery cloth. Grasp the part at the lower end, with your thumb over the spanner-wrench hole, and lap the part in a straight line across the emery cloth. Do not apply downward pressure — the weight of the part alone provides sufficient pressure.
6	Lap the part, two or three times, in the same direction against the emery cloth (Figure 7.1 Reconditioning Stack Surfaces).
7	Rotate the part 120 degrees, placing your thumb over the spanner-wrench hole, and repeat the lapping procedure in step 6.
8	Rotate the part another 120 degrees to the next spanner-wrench hole, and repeat the lapping procedure in step 6.
9	Re-examine the mating surface. If necessary, repeat steps 2-5 until you remove most of the contaminant. Remember, this should not require more than two to three complete rotations for an aluminum horn or booster; a titanium component may require more rotations.
10	<p>Before re-inserting a threaded stud in an aluminum booster or horn:</p> <ul style="list-style-type: none"> Using a file card or wire brush, clean any aluminum bits from the knurled end of the stud Using a clean cloth or towel, clean the threaded hole <p>Examine the knurled end of the stud. If worn, replace the stud. Also, examine the stud and threaded hole for stripped threads</p>
<p>CAUTION</p> <p>Threaded studs cannot be reused in titanium horns or boosters. Replace all studs in these components.</p>	
11	Assemble and install the stack, referring to Section 4.8 Assemble the Acoustic Stack .

Figure 7.1 Reconditioning Stack Surfaces

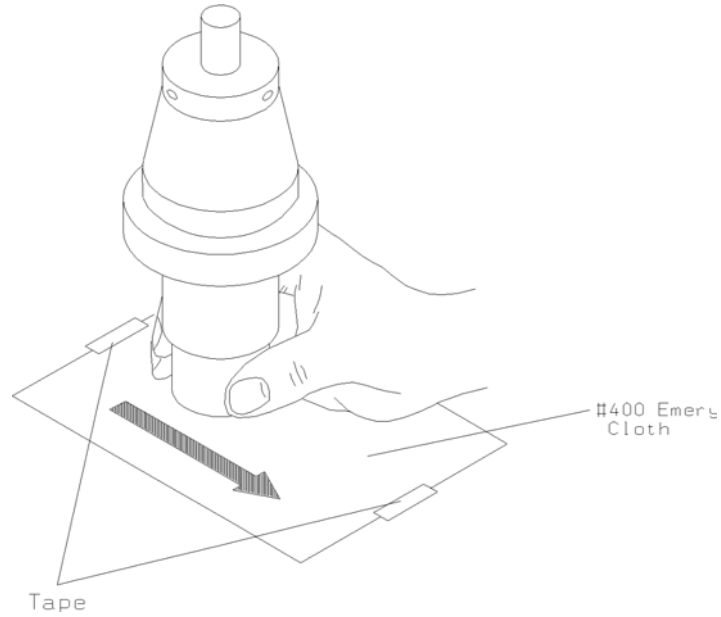

7.1.3 Servicing the Air Filter (Part No. 200-163-009)

The Air Filter is self-draining. If contaminants build up inside the Air Filter, you can bleed the filter by turning the brass nut on the bottom. If your Air Filter leaks or gets dirty, follow the instructions below.

Figure 7.2 Disassembly of Air Filter Components

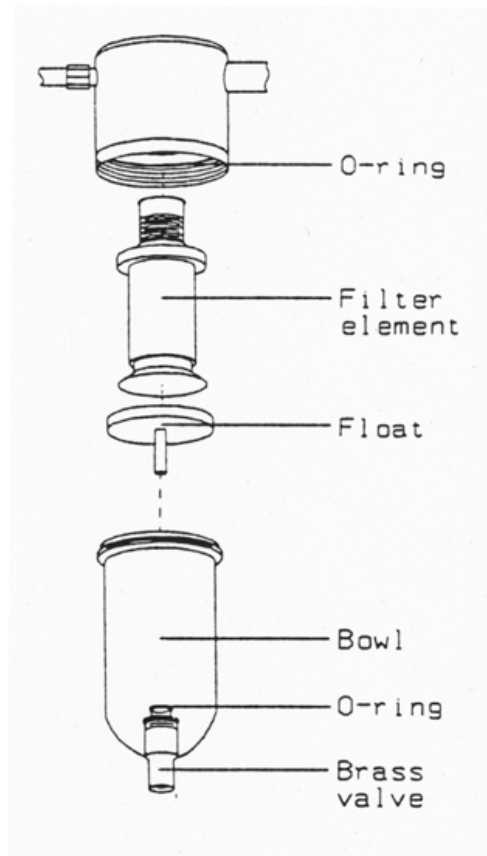

1. Turn air pressure to zero and disconnect the main air supply

WARNING	General Warning
	<p>Turn air pressure to zero and disconnect the air line connection. Failure to do this leaves the welder under potentially dangerous air pressure.</p>

2. Unscrew the bowl from the housing
3. Unscrew the filter element from the housing
4. Remove the float from the bowl

WARNING	General Warning
	<p>Clean the bowl with household soap only. Never clean the bowl with a solvent.</p>

5. Clean the inside of the bowl with household soap
6. Inspect the O-rings. If the Air Filter leaks, check both O-rings. If one or both of the O-rings is bad, replace the Air Filter
7. Clean the float and filter element
8. Reassemble the Air Filter as follows:
 - Place the float into the bowl ([Figure 7.2](#))
 - Screw the filter element into the housing until finger-tight
 - Screw the bowl into the housing

7.2 Parts Lists

Table 7.2 Replacement Parts

Description	Part Number
Fuse, 3/4 Amp	200-049-089R
Circuit Breaker, 8A	200-167-014R
Circuit Breaker, 17A	200-167-015R
Kit, Controller 2000 IW and IW+	101-063-718
Membrane Keypad 2000 IW	100-242-560
Membrane Keypad 2000 IW+	100-242-561
AC/DC Universal Supply	200-132-777R
PC BD Line IW UPS	100-242-546R
Kit, Power Module 1.1 kW, 2000 IW	101-063-719
Kit, Power Module 2.2 kW, 2000 IW	101-063-720
2000 IW/IW+ Operators Manual	1019568
2000 IW/IW+ Maintenance Manual	1019567
Kit, Fan	101-063-722
Kit, Accessory Input/Output Connection	101-063-721
PCB Display IW	100-242-1101R
PCB Display IW+	100-242-1202R
Kit, Controller 2000 IW and IW+	101-063-718
Kit, Linear Encoder with Installation Instructions	101-063-553

7.3 Circuits

Figure 7.3 2000 IW/IW+ Interconnect Schematic.

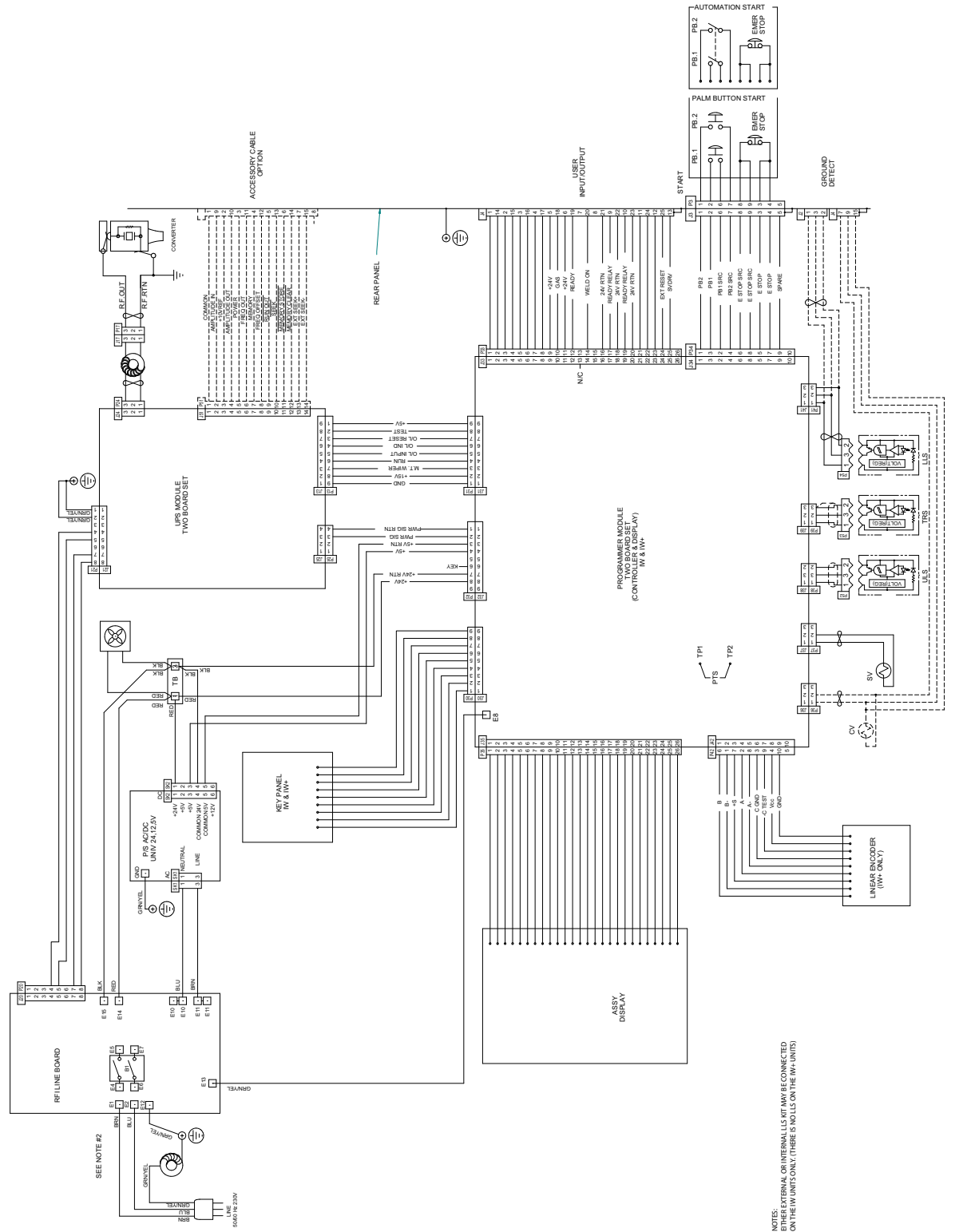

7.4 Troubleshooting

Troubleshooting information can be found in the 2000IW/IW+ Maintenance Manual, EDP 1019567.

7.4.1 Manual Tuning

NOTICE	
	This should NOT be a regularly performed procedure, but should be used only as a last resort.

If there is an instance where Autotune does not provide proper tuning, using the following procedure.

Remove the Autotune label from the Front Panel.

CAUTION	
	General Warning Do not force the potentiometer beyond its stop limits. The total rotation from full cw to full ccw is only 270°.

Figure 7.4 Manual Adjustment Procedure Flowchart



Index

Numerics

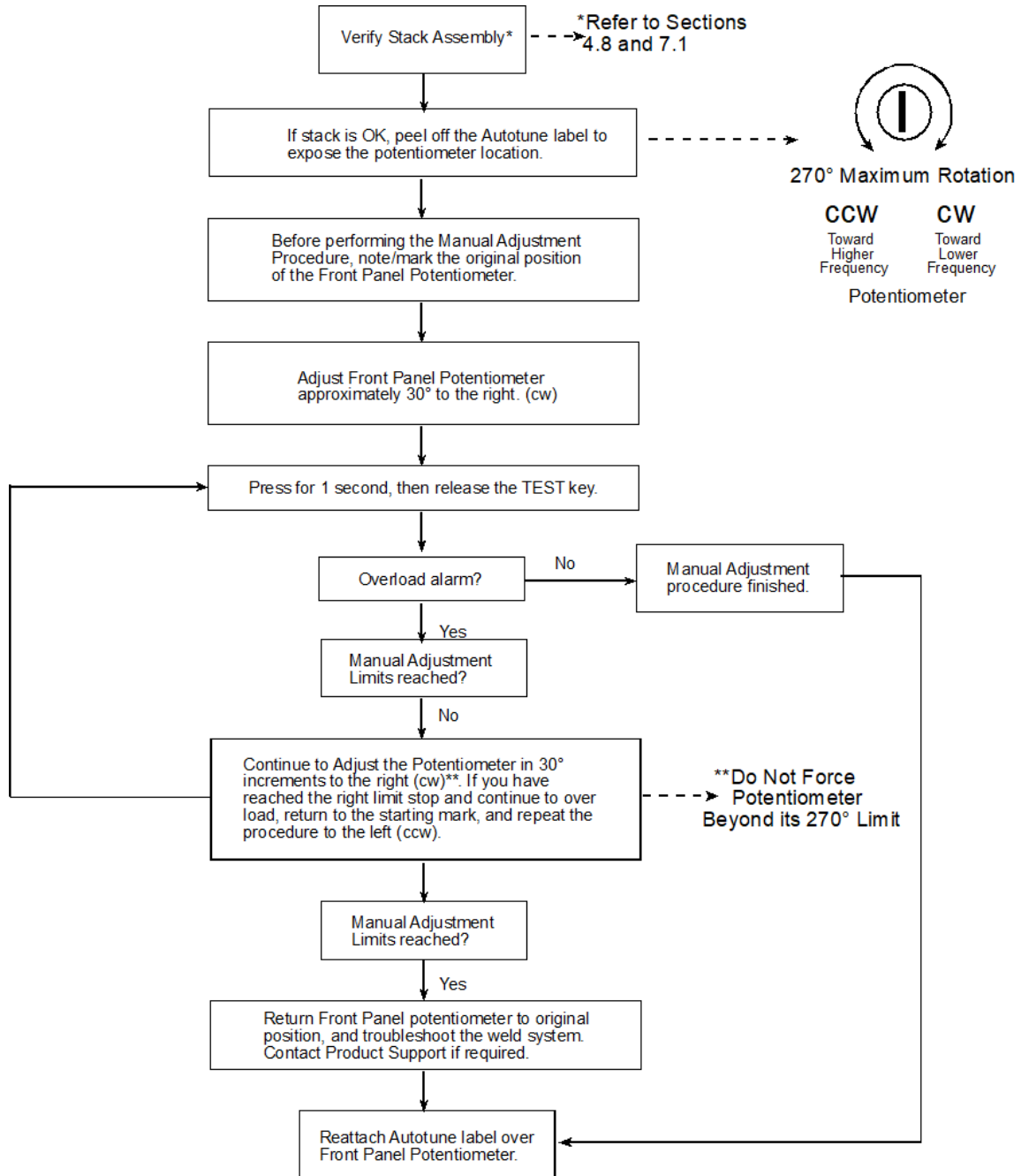
2000IW/IW+ Boosters 78

A

Accessory Input/Output Connector Pinout 60
Accessory Input/Output Option 60
Acorn nut 65
Actual Values IW+ only 84
Air filter 47, 76
Air Filter specs 47
AIR INLET 48
Allen wrench
 M8 44
Assemble the Acoustic Stack 62
Automation 52

B

Base Mounting Centers 50
Basic installation 40
Booster clamp ring 62
Branson
 how to contact 8

C

Cables 44
Carriage and Slide System 16
Circuit Descriptions 77
Clearing Weld Cycle Alarms 105
Column Clamps 42, 43
Compatibility with Branson Products 18
Connect factory air 51
Connecting Tip to Horn 64
Converter Cooling 110
Converters and Boosters 78
Counterbalance spring 42, 43

D

Damage from shipping 41
DC Power Module 78
Disclaimer of Warranty 6
Down speed adjustment 85
Dynamic Triggering and Follow-Through 17

E

Electrical Requirements 76
Electro-static discharge 57
Emergency Stop Button

- reset 61
- Emergency Stop Control 61
- Emergency Stop signal 61
- Emissions 5
- Environmental Specifications 34, 76
- Equipment
 - Returning 37
- Error Codes 103
- EXTERNAL RESET - ALARM Connector 29

F

- Factory Air Supply 47
 - clean Specs 47, 76
 - maximum pressure 47, 76
- Features 19
- Fixture Bolts and Washer 44
- Front Panel Controls 20

G

- GENERAL ALARM - Alarm Connector 29
- Glossary of Terms 31

H

- Handling and Unpacking 41
- Hazardous Voltages 57
- Help 73
- Horn Down 109
- How to contact Branson 8

I

- In-line air filter 47, 76
- Input Power Plug 56
- Installation Steps 49
- Installing the Ultrasonic Stack 65
- International Harmonized Line Cord Color Code 56
- Inventory of Small Parts 43

J

- Jack screws 51

K

- Kit 79

L

- Latchable alarms 106
- Limits IW+ only 84
- Line Board 77
- Linear Encoder 43
- Linear Optical Encoder 16
- List of Cables 44

M

- Maintenance 111
- Modifying Parameter Values 92

- Modifying Weld Modes 82, 84, 85
- Mounting Circles on Base 66
- Mounting holes, stripping 66
- Mounting the Stand
 - (Welder on Hub-mounted column) 50
- Moving Jumpers 56
- Mylar Washer Kit 44
- Mylar washers 62
- Mylar® Washers 79

N

- Non-Resettable alarms 106

O

- Operating Cycle Timing Table, 2000IW 55
- Operating Cycle Timing Table, 2000IW+ 55
- Operation 81
- Other items used with the 2000IW/IW+ 78
- Output Circuit 78
- Overtightened 66
- Overview of these Models 15

P

- Packing material 41
- Parameters 82
- Parts 73
- Parts Lists 116
- Periodic Maintenance Procedures 112
- Physical Description 76
- Pneumatic Requirements 76
- Pneumatic System 16
- Pneumatic Tubing and Connectors 48
- Power Supply Module 16
 - Module Options DIP Switch 57
- Pretrigger Settings 84
- Pretriggering 84
- Preventive Maintenance 112
- PVC Materials 5

Q

- Questions 73

R

- READY Signal - ALARM Connector 29
- Ready to weld 40
- Rear Panel 27
- Receiving 35
- Reconditioning the Stack 112
- Regulatory Compliance 5
- Resetting the System 107
- Returning Equipment 37
- Returning Equipment for Repair 9

S

- Safety

- Guards 61
- PVC Materials 5
- Safety Equipment 61
- Selecting a Parameter to Modify 92
- Servicing the Air Filter 114
- Setting Weld Cycle Parameters 92, 93
- Shipping and Handling 34
- Shock 34
- Silicone grease 62
- Small Parts Inventory 44
- Spanners 44
- Stack Assembly Torque Tables 64
- Stand (Welder on a Hub) 42
- Start Switch
 - Connection Codes 52
- Start Switch/E-stop connections 52
- START SWITCHES/START Signal - START Connector 29
- Stop button 61
- Storing Parameters 93
- Stud Torque Values 64
- Studs 79
- System Control Board 77
- System Control Module 16
- System Inputs/Outputs 29

T

- Technical Specifications 76
- Temperature
 - Shipping and Storage 34
- TEST 108
- Testing the Installation 71
- T-Handle Wrench 44
- Tip to Horn connection 64
- Toolkit 42
- Torque 62
 - carriage door 65
- Torque Tables
 - Stack Assembly 64
- Torque wrench 64

U

- Ultrasonic Converter 43
 - J-Type for stand-alone use 43
- Ultrasonic Power Module
 - Main Circuits 78
- Ultrasonic Stack
 - Installing in the Welder 65
- Ultrasonic Test 108
- Unpacking 36
- Unpacking and Handling 41
- Upper Limit Switch 17
- User I/O 29
 - User I/O Connector 17
 - User I/O Interface 53

V

Vibration 34

W

Warranty 6

Weld Modes 82

WELD ON Signal - Alarm Connector 30

Weld Parameter Values IW+ only 92

Welder the Stand (Welder on Base) 49

