

# Rosemount™ 4088 MultiVariable™ Transmitter





# Contents

## Section 1: Introduction

1.1 Using this manual .....	1
1.1.1 Models covered.....	1
1.2 Product recycling/disposal.....	1

## Section 2: Configuration

2.1 Safety messages.....	3
2.2 Software installation and initial setup .....	4
2.2.1 System requirements .....	4
2.2.2 RTIS part numbers .....	4
2.2.3 Installing the RTIS.....	4
2.2.4 Getting started with RTIS .....	5
2.2.5 Connecting to a personal computer.....	7
2.3 Launching the configuration process.....	8
2.4 Basic device configuration .....	10
2.4.1 Units of measure and damping .....	10
2.4.2 Network .....	11
2.5 Detailed device configuration.....	12
2.5.1 Display .....	12
2.5.2 Device information .....	14
2.5.3 Overview variables.....	14
2.5.4 Alert setup .....	15
2.6 Variable configuration .....	16
2.6.1 Differential pressure .....	16
2.6.2 Static pressure.....	16
2.6.3 Process temperature .....	17
2.6.4 Module temperature .....	19
2.7 Menu trees and Field Communicator.....	20
2.7.1 Rosemount 4088A menu tree .....	21
2.7.2 Rosemount 4088B menu tree .....	27
2.7.3 Field Communicator .....	33
2.8 Rosemount 4088A configuration with legacy tool .....	34

## Section 3: Installation

3.1 Overview .....	35
3.2 Safety messages.....	35
3.3 Considerations .....	36
3.3.1 General.....	36
3.3.2 Mechanical .....	37
3.3.3 Environmental .....	37
3.4 Steps required for quick installation.....	37
3.4.1 Mount the transmitter.....	38
3.4.2 Consider housing rotation .....	42
3.4.3 Set the switches .....	43
3.4.4 Wiring and power up .....	44
3.4.5 Verify device configuration.....	48
3.4.6 Trim the transmitter .....	48
3.5 Rosemount 305, 306, and 304 Manifolds.....	49
3.5.1 Rosemount 305 Integral Manifold installation procedure .....	49
3.5.2 Rosemount 306 In-line Manifold installation procedure.....	50
3.5.3 Rosemount 304 Conventional Manifold installation procedure .....	50
3.5.4 Rosemount 305 and 304 Manifold styles.....	51
3.5.5 Manifold operation.....	52

## Section 4: Communication

4.1 Rosemount 4088A Modbus communications .....	57
4.1.1 Modbus communication overview .....	57
4.1.2 Modbus data types.....	58
4.1.3 Modbus function codes.....	59
4.1.4 Registers for process variables .....	59
4.1.5 Process variable integer scaling .....	60
4.1.6 Floating point formats.....	61
4.1.7 Communications .....	62
4.1.8 Implementing calibration .....	62
4.1.9 Diagnostics .....	63
4.1.10 Transmitter register maps .....	65
4.2 Rosemount 4088B ROC communications.....	77
4.3 Rosemount 4088B BSAP communications .....	78
4.3.1 Rosemount 4088B BSAP communications signals.....	78



## Section 5: Operation and Maintenance

5.1 Calibration	105
5.1.1 Sensor trim overview	105
5.1.2 Differential pressure sensor calibration	106
5.1.3 Static pressure sensor calibration	109
5.1.4 Process temperature sensor calibration	109
5.1.5 Offset	110
5.1.6 Verification	111
5.1.7 Legacy calibration	111
5.2 Simulate device variables	112

## Section 6: Troubleshooting

6.1 Overview	113
6.2 Safety messages	113
6.3 Communications troubleshooting	114
6.4 Alarms and conditions	115
6.5 Field upgrades and replacements	117
6.5.1 Disassembly considerations	117
6.5.2 Housing assembly including electronics board	117
6.5.3 Terminal block	119
6.5.4 LCD display	120
6.5.5 Flange and drain vent	120
6.6 Service support	122

## Appendix A: Reference Data

A.1 Product Certifications and Installation Drawings	123
A.2 Ordering Information, Specifications, and Dimensional Drawings	123
A.3 Spare parts list	123



---

# Rosemount™ 4088 MultiVariable™ Transmitter

## NOTICE

Read this manual before working with the product. For personal and system safety, and for optimum product performance, make sure the contents are fully understood before installing, using, or maintaining this product.

For technical assistance, contacts are listed below:

### **Customer Central**

#### **Technical support, quoting, and order-related questions**

United States - 1-800-999-9307 (7:00 am to 7:00 pm CST)

Asia Pacific- 65 777 8211

Europe/Middle East/Africa - 49 (8153) 9390

### **North American Response Center**

#### **Equipment service needs**

1-800-654-7768 (24 hours—includes Canada)

Outside of these areas, contact your local Emerson™ representative.

To view current Rosemount 4088 Product Certifications and EC Declarations of Conformity, follow these steps:

1. Go to [Emerson.com/Rosemount/4088](https://Emerson.com/Rosemount/4088).
2. Scroll as needed to the green menu bar and click **Documents & Drawings**.
3. Click **Certificates & Approvals**.

The manual and this guide are also available electronically on [Emerson.com/Rosemount](https://Emerson.com/Rosemount).

---

## ⚠ WARNING

### **Failure to follow these installation guidelines could result in death or serious injury.**

Make sure only qualified personnel perform the installation.

### **Explosions could result in death or serious injury.**

- Do not remove the transmitter cover in explosive atmospheres when the circuit is live.
- Before connecting a communicator in an explosive atmosphere, make sure the instruments in the loop are installed in accordance with intrinsically safe or non-incendive field wiring practices.
- Both transmitter covers must be fully engaged to meet explosion-proof requirements.
- Verify the operating atmosphere of the transmitter is consistent with the appropriate hazardous locations certifications.

### **Electrical shock could cause death or serious injury.**

- If the sensor is installed in a high-voltage environment and a fault or installation error occurs, high voltage may be present on the transmitter leads and terminals.
- Use extreme caution when making contact with the leads and terminals.

### **Process leaks could result in death or serious injury.**

- Install and tighten all four flange bolts before applying pressure.
- Do not attempt to loosen or remove flange bolts while the transmitter is in service.
- Replacement equipment or spare parts not approved by Emerson for use as spare parts could reduce the pressure retaining capabilities of the transmitter and may render the instrument dangerous.
- Use only bolts supplied or sold by Emerson as spare parts.

### **Improper assembly of manifolds to traditional flange can damage sensor module.**

For safe assembly of manifold to traditional flange, bolts must break back plane of flange web (i.e., bolt hole) but must not contact module housing.

### **Sensor module and electronics housing must have equivalent approval labeling in order to maintain hazardous location approvals.**

When upgrading, verify sensor module and electronics housing certifications are equivalent. Differences in temperature class ratings may exist, in which case the complete assembly takes the lowest of the individual component temperature classes (for example, a T4/T5 rated electronics housing assembled to a T4 rated sensor module is a T4 rated transmitter.)

## ⚠ CAUTION

The products described in this document are NOT designed for nuclear-qualified applications. Using non-nuclear qualified products in applications that require nuclear-qualified hardware or products may cause inaccurate readings.

For information on Rosemount nuclear-qualified products, contact your local Emerson Sales Representative.

Individuals who handle products exposed to a hazardous substance can avoid injury if they are informed of and understand the hazard. If the product being returned was exposed to a hazardous substance as defined by OSHA, a copy of the required Material Safety Data Sheet (MSDS) for each hazardous substance identified must be included with the returned goods.

# Section 1 Introduction

## 1.1 Using this manual

The sections in this manual provide information on installing, operating, and maintaining the Rosemount™ 4088 MultiVariable™ Transmitter. The sections are organized as follows:

- **Section 2: Configuration** contains mechanical and electrical installation instructions.
- **Section 3: Installation** provides details about the communication protocols supported by the transmitter.
- **Section 4: Communication** contains information on software functions, configuration parameters, and online variables.
- **Section 5: Operation and Maintenance** provides techniques for calibrating the transmitter.
- **Section 6: Troubleshooting** contains troubleshooting techniques for the most common operating problems.
- **Appendix A: Reference Data** provides links to product certifications, installation drawings, ordering information, specifications, and dimensional drawings.

### 1.1.1 Models covered

The following Rosemount 4088 Transmitters are covered in this manual.

**Table 1-1. Rosemount 4088 Coplanar™ Transmitter**

Measurement type	Description
1	Differential pressure, static pressure, temperature
2	Differential pressure and static pressure
3	Differential pressure and temperature
4	Differential pressure
5	Static pressure and temperature
7	Static pressure

**Table 1-2. Rosemount 4088 In-line Transmitter**

Measurement type	Description
6	Static pressure and temperature
8	Static pressure

## 1.2 Product recycling/disposal

Recycling of equipment and packaging should be taken into consideration and disposed of in accordance with local and national legislation/regulations.



## Section 2 Configuration

---

Safety messages .....	page 3
Software installation and initial setup .....	page 4
Launching the configuration process .....	page 8
Basic device configuration .....	page 10
Detailed device configuration .....	page 12
Variable configuration .....	page 16
Menu trees and Field Communicator .....	page 20
Rosemount 4088A configuration with legacy tool .....	page 34

---

The Rosemount™ Transmitter Interface Software (RTIS) is a PC-based application that performs configuration and maintenance functions for the Rosemount 4088 MultiVariable™ Transmitter.

Instructions for performing configuration functions are given for the RTIS. Field Communicator Fast Key sequences are labeled “Field Communicator” for each software function below the appropriate headings.

---

### Note

Coplanar transmitter configurations measuring gage pressure with optional process temperature (measurement type 5 and 7) will report the pressure as differential pressure. This will be reflected on the LCD display nameplate, digital interfaces, and other user interfaces.

---

## 2.1 Safety messages

Instructions and procedures in this section may require special precautions to ensure the safety of the personnel performing the operations. Refer to the following safety messages before performing an operation.

### WARNING

**Failure to follow these installation guidelines could result in death or serious injury.**

Make sure only qualified personnel perform the installation.

**Explosions could result in death or serious injury.**

- Do not remove the transmitter cover in explosive atmospheres when the circuit is live.
- Verify the operating atmosphere of the transmitter is consistent with the appropriate hazardous locations certifications.
- Both transmitter covers must be fully engaged to meet explosion-proof requirements.

**Electrical shock could cause death or serious injury.**

- If the sensor is installed in a high-voltage environment and a fault or installation error occurs, high voltage may be present on the transmitter leads and terminals.
  - Use extreme caution when making contact with the leads and terminals.
-

## 2.2 Software installation and initial setup

### 2.2.1 System requirements

The following are the minimum system requirements to install the RTIS:

- Microsoft® Windows™ 7 Operating System (32-bit or 64-bit)

Recommended hardware driver for USB modem option

- MACTek® VIATOR® Modem Driver (included)

### 2.2.2 RTIS part numbers

The Rosemount 4088 MultiVariable Transmitter is not shipped with RTIS; the RTIS can be ordered separately using the part numbers below.

RTIS CD only: **04088-9000-0001**

RTIS CD with HART® USB modem and cables: **04088-9000-0002**

### 2.2.3 Installing the RTIS

Multiple DTMs™ are available on the RTIS, however the following FDT® frame and DTMs are required for this installation:

- RTIS
- Rosemount HART Comm DTM (Communications driver)
- Rosemount 4088 Device DTM (Rosemount 4088 User interface Configuration application)

1. Right click the **setup.exe** file and select **Run as administrator**.

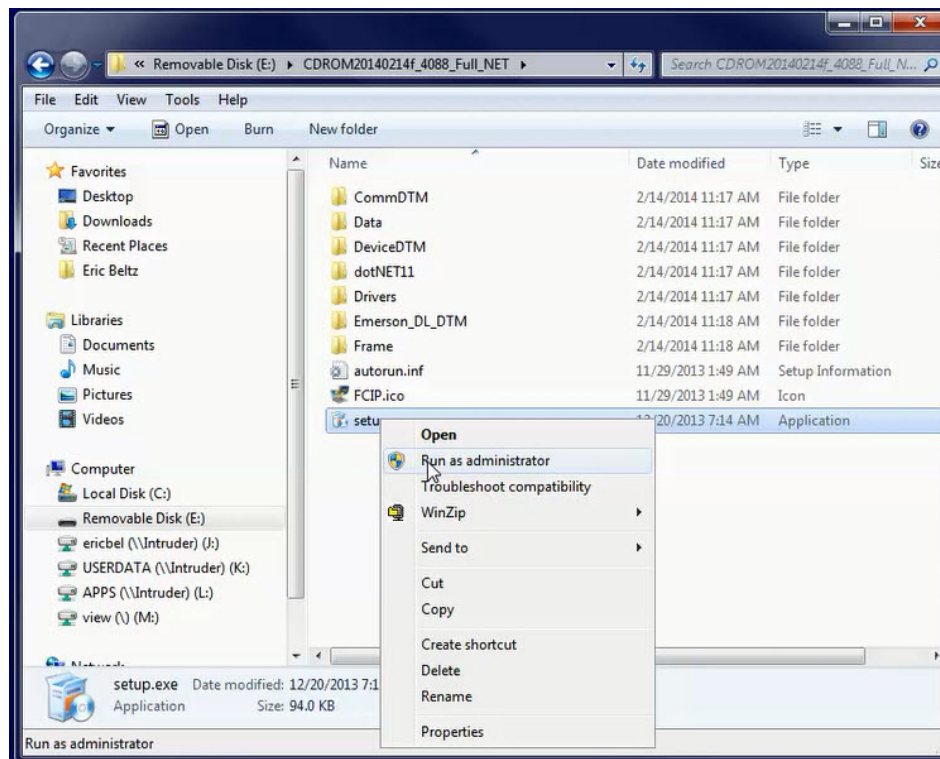



2. Follow the installation wizard. Select all desired DTMs (the first three are required).

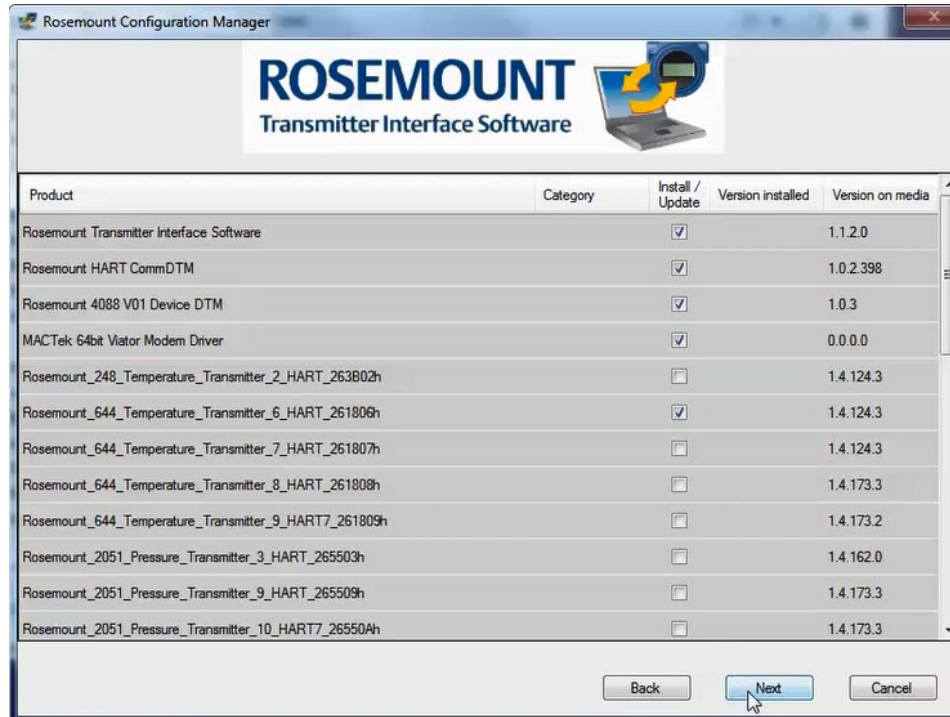

#### Note

The MACTek modem install will also be automatically selected to run. If the MACTek VIATOR Utility is already installed, this install will allow you to repair or update. For each additional DTM selected, you will be prompted for individual installation options. Once installation has started, the next prompt would be for any optionally-selected HART Device DTMs.

3. Run a complete installation for the HART Modem driver and each additional selected DTM. This completes the installation.

## 2.2.4 Getting started with RTIS

1. Ensure the modem is connected.
2. Launch RTIS from the desktop or *All Programs* menu option.

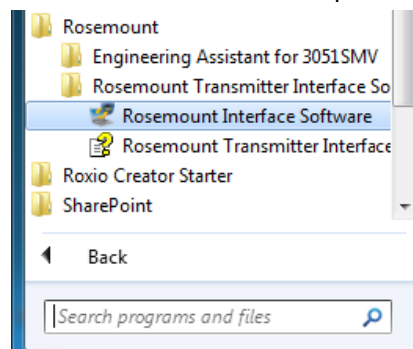

3. Right click **My Network**, and then select **Add...**

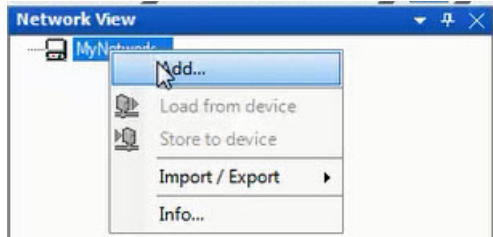

4. Select **Rosemount HART CommDTM** for Device Type and select **OK**.

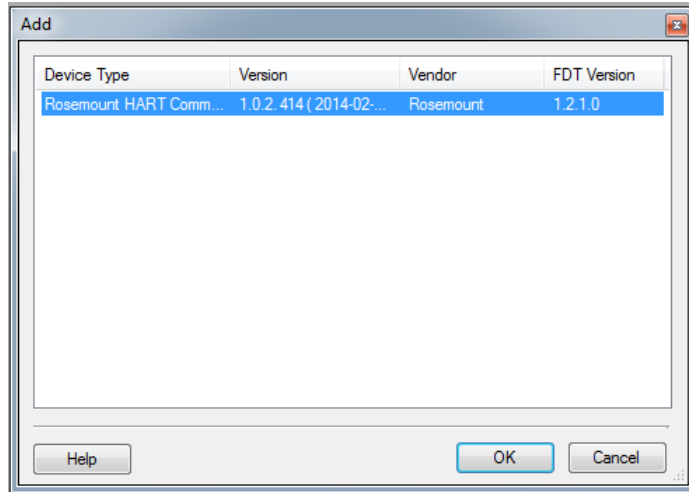

5. Under *MyNetwork*, right click **Rosemount HART CommDTM**, then select **Configuration**.

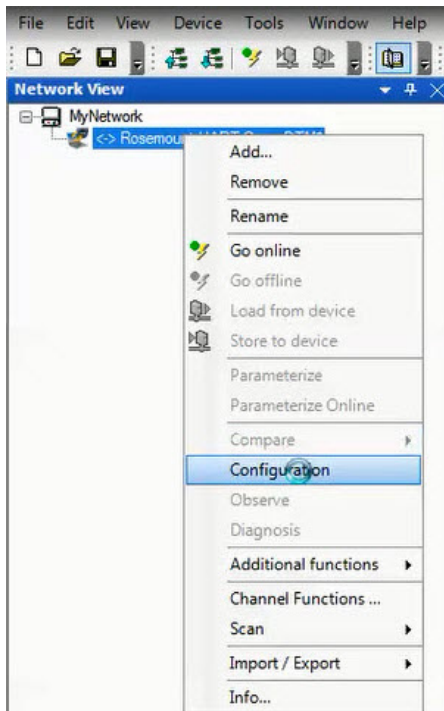

6. Select the correct COM Port.
7. Select the *Access Mode* dropdown and set to **Emulated**.

8. Select **Self Test** to check the connection.

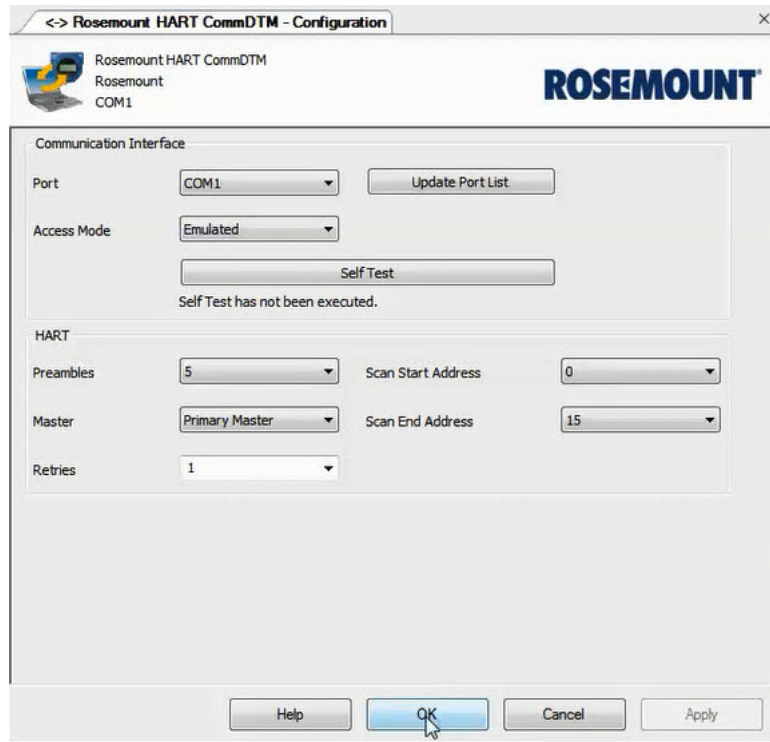

9. Select **OK**.

## 2.2.5 Connecting to a personal computer

Figure 2-1 shows how to connect a device to either a computer with the RTIS or a handheld communicator.

**Figure 2-1. Connecting a Personal Computer to a Transmitter**

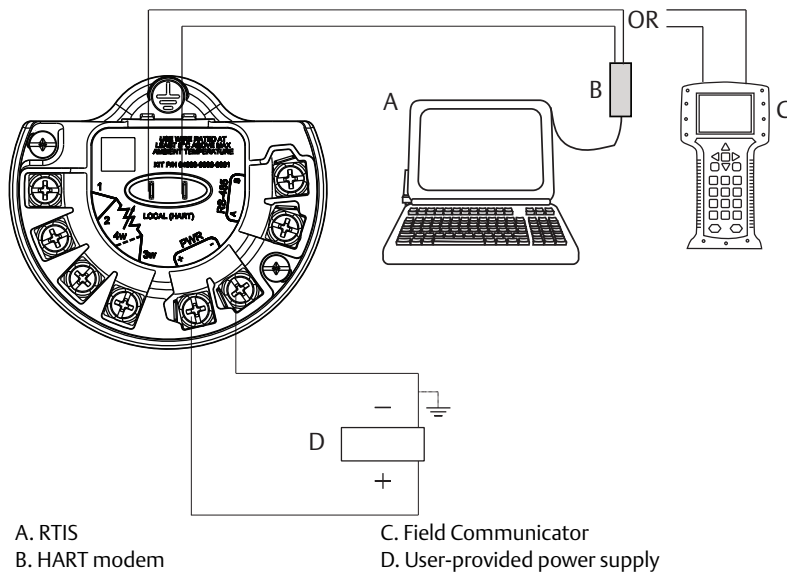

1. Wire the device as detailed in [Section 3: Installation](#).
2. Connect the MACTek HART modem to the correct USB communications port on the PC as set up in “Getting started with RTIS” on page 5.
3. Remove the cover of the transmitter above the side marked “FIELD TERMINALS.”
4. Connect the mini-grabber connectors to the “LOCAL (HART)” terminals.

**⚠ WARNING**

**Explosions can cause death or serious injury.**

Do not remove the instrument cover in explosive atmospheres when the circuit is live.

## 2.3 Launching the configuration process

This section outlines how to configure the transmitter using the RTIS.

1. Right click **Rosemount HART CommDTM**, select **Scan**, then select **Create Network**.

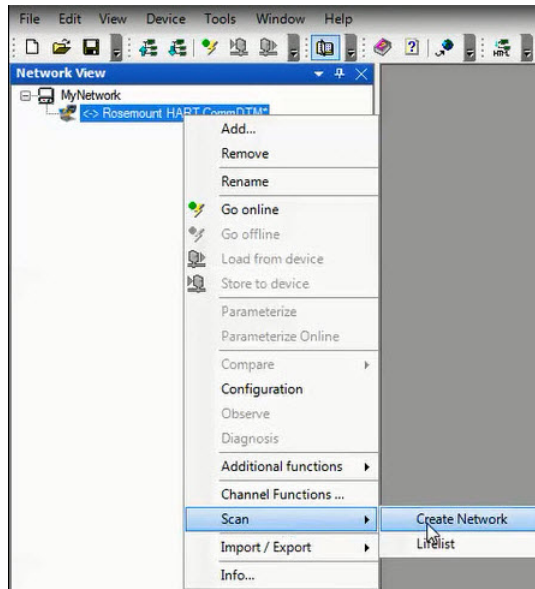

The DTM setup is complete.

2. Right click on the transmitter, then select **Go Online**. Your device is now online.

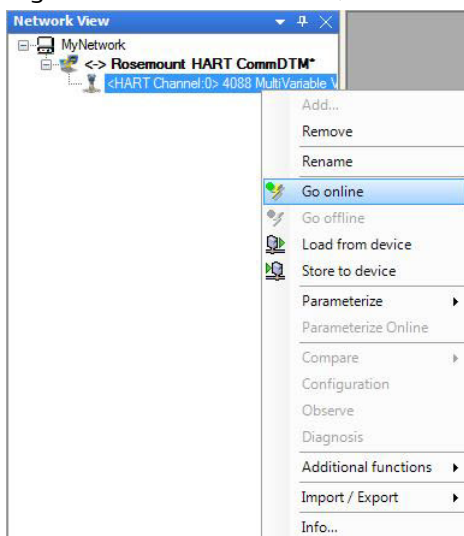

3. Right click on the transmitter again, select **Parameterize Online**, then select **Configure/Setup**.

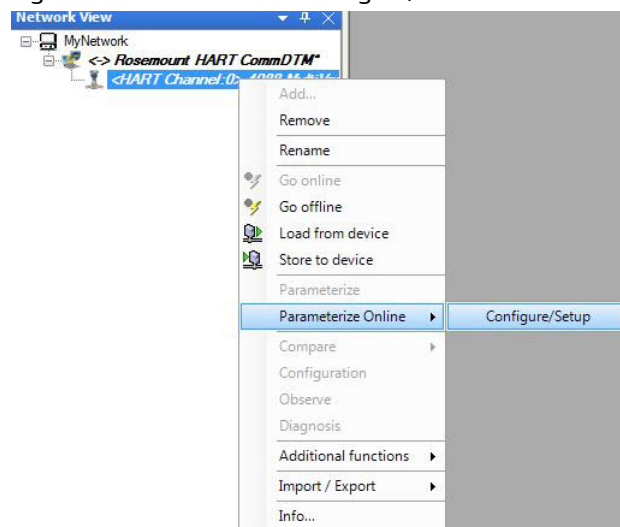

## 2.4 Basic device configuration

The *Guided Setup* section provides procedures to commission the transmitter. The **Basic Setup** button can be used to perform all of the required transmitter configuration. See [Table 2-2 on page 33](#) for the complete list of Field Communicator for basic setup.

Figure 2-2. Guided Setup Tab

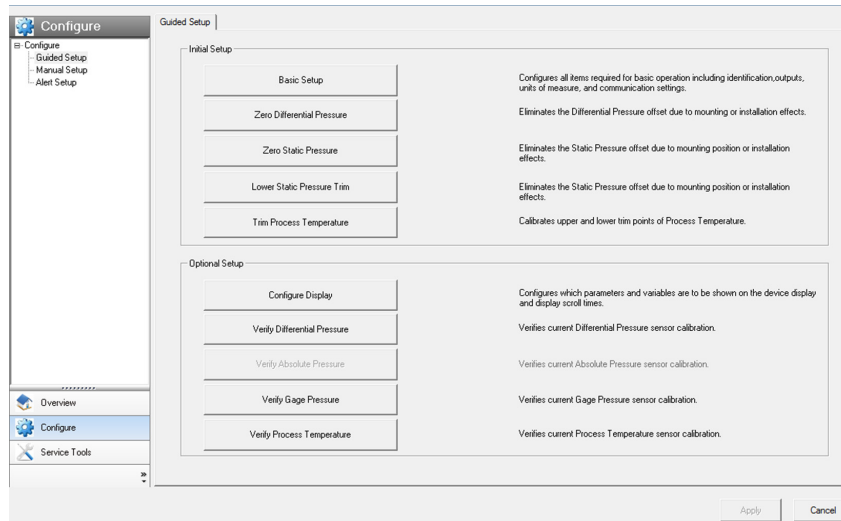

All screens in this section are shown for measurement type 1 (differential pressure, static pressure [absolute], and process temperature) with LCD display. Field Communicator are given for a transmitter with Measurement type 1. Field Communicator and screens for other multivariable types and measurement types may vary.

### Note

All screens in this section are shown using the RTIS. Edited information is not sent to the transmitter until the **Send** button is selected.

### 2.4.1 Units of measure and damping

<b>Fast Keys</b>	Units: 2, 1, 1, 2 Damping: 2, 1, 1, 3
------------------	--

The damping command changes the response time of the transmitter; higher values can smooth variations in output readings caused by rapid input changes. Determine the appropriate damping setting based on the necessary response time, signal stability, and other requirements. The damping command utilizes floating point configuration allowing the user to input any damping value between 0 and 60 seconds.

The units and damping for each process variable may be edited by selecting **Manual Setup** in the menu tree and then the appropriate tab as detailed below:

- Under the *Differential Pressure* tab, the Units and Damping for the Differential Pressure may be edited.
- Under the *Static Pressure* tab, the Units and Damping for the Static Pressure may be edited.

**Note**

Both absolute and gage pressure are available as variables. The type of transmitter ordered will determine which variable is measured and which is calculated based on the user defined atmospheric pressure. For more information on configuring the atmospheric pressure, see “[Static pressure](#)” on [page 16](#). Since only one of the static pressures is actually being measured, there is a single damping setting for both variables which may be edited under the Static Pressure tab.

- Under the *Process Temperature* tab, the Units and Damping for the Process Temperature may be edited.
- Under the *Module Temperature* tab, the Units for the Module Temperature may be set. The sensor module temperature measurement is taken within the module, near the differential pressure and/or static pressure sensors and can be used to control heat tracing or diagnose device overheating.

## 2.4.2 Network

<b>Fast Keys</b>	2, 2, 6, 1
------------------	------------

### Device address

In the *Network* tab, the *Device Address* field can be used to set the device's address under the Modbus® Configuration heading.

**Figure 2-3. Network Tab**

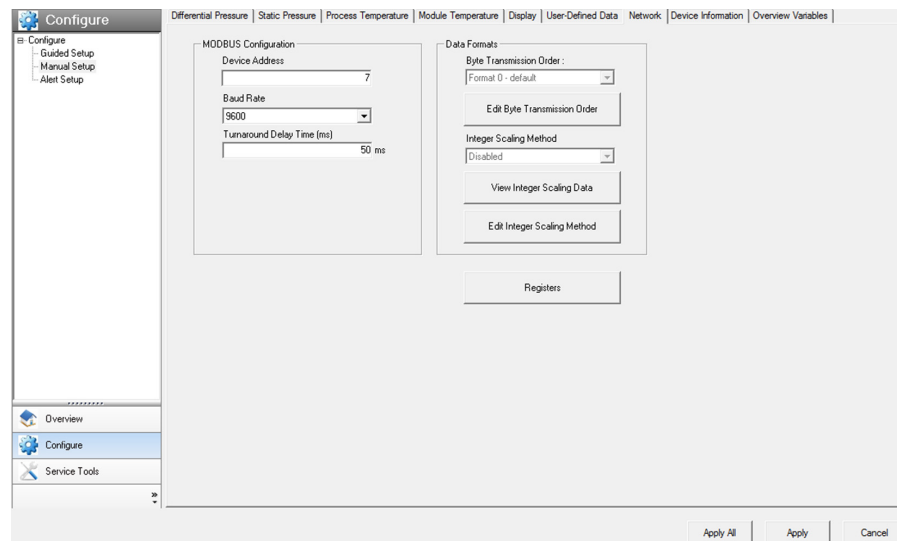

### Baud rates

The baud rate is user selectable under the *Modbus Configuration* heading.

For default and available baud rates, see “[Baud rate \(software configurable\)](#)” on [page 57](#).

### Turn around delay

The *Turnaround Delay Time (ms)* field can be used to configure the device’s turnaround delay time. For more information, reference “[Communications](#)” on [page 62](#).

## 2.5 Detailed device configuration

### 2.5.1 Display

<b>Fast Keys</b>	2, 2, 5
------------------	---------

The LCD display features a four-line display. The first line of five characters displays the output description, the second line of seven digits displays the actual value, and the third line of six characters displays engineering units. The fourth line displays “Error” when there is a problem detected within the transmitter. The LCD display can also display diagnostic messages. These diagnostic messages are listed in “Alarms and conditions” on page 115.

The *Display* tab allows the user to configure which variables will be shown on the LCD display. Click the check box next to each variable to select a variable for display. The transmitter will scroll through the selected variables, showing each for three seconds as a default setting.

Figure 2-4. Display Tab

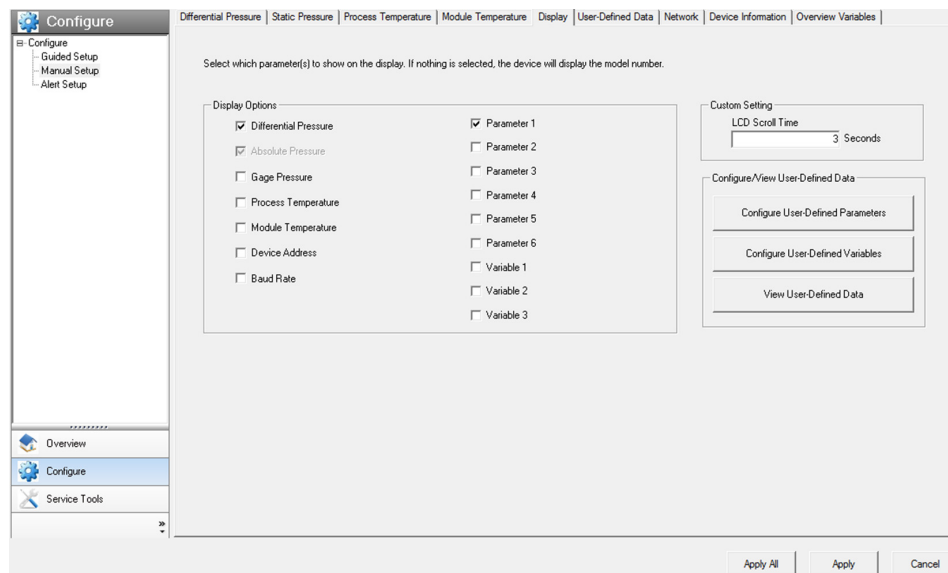

The *Display* tab includes three types of display options (information that appears on the LCD display) including Device Variables, User-Defined Parameters, or User-Defined Variables.

### Device variables

The device variables include Differential Pressure, Absolute Temperature, Gage Pressure, Process Temperature, Module Temperature, Device Address or Baud Rate. These display variables can be selected or deselected on the left column of the Display Options heading.

### User-defined parameters

The User-Defined Parameters fields are for pieces of information the device can store for reference. The device will not modify or update these parameters but they can be written by the user or a host system to be displayed on the LCD display and include Beta Ratio, Pipe Schedule, or Orifice Bore. If the device loses power at any point during operation, these values are stored in memory and will not be lost.



To configure User-Defined Parameters, select **Configure User-Defined Parameters**. A screen will appear as shown below:

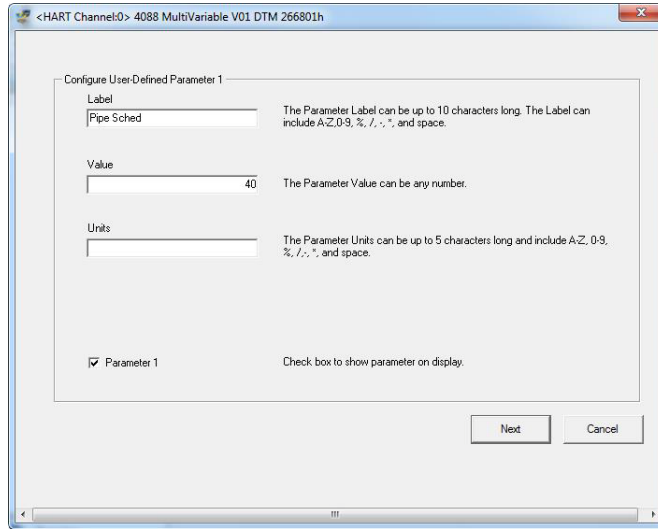

Each parameter can be given a label, value and unit to be stored inside the device.

## User-defined variables

### Note

Only the value of the user-defined variables should be written on a periodic basis. Regular writes to the other parameters may cause the device memory to fail.

The *User-Defined Variable* fields are for pieces of information that the device can store for a live reference of the application status or production levels, via Modbus. The device itself will not modify or update these variables; rather this is intended to be a live value sent to the device from a host, such as a flow computer or Remote Terminal Unit (RTU). This information can then be displayed on the device's LCD display and include variables such as Last 24-Hours of Gas Volume or Instantaneous Flow Rate.

To configure User-Defined Variables, select **Configure User-Defined Variables**. A screen will appear as shown below:

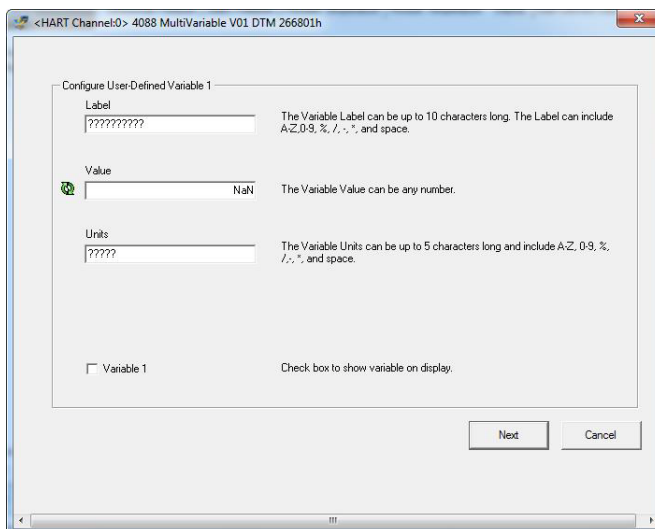

Similar to the *User-Defined Parameters* screen, you can input a label and unit for each variable, however the value will be written by the flow computer or host. The user must program the flow computer or host separately to write the value to the device. If the device loses power at any point during operation, the value will be lost, but the Label and Units will not be lost.

**Note**

If the transmitter is ordered without an LCD display, the User-Defined Parameters and User-Defined Variables are still available but are configured through the *User-Defined Data* tab in Manual Setup rather than accessing them through the *Display* tab.

### LCD display scroll time

The LCD display scroll time controls the amount of time each variable is displayed on the LCD display.

## 2.5.2 Device information

<b>Fast Keys</b>	2, 2, 7
------------------	---------

The *Device Information* tab displays the device identification information on one screen including tags, model numbers and assembly information.

**Figure 2-5. Device Information Tab**

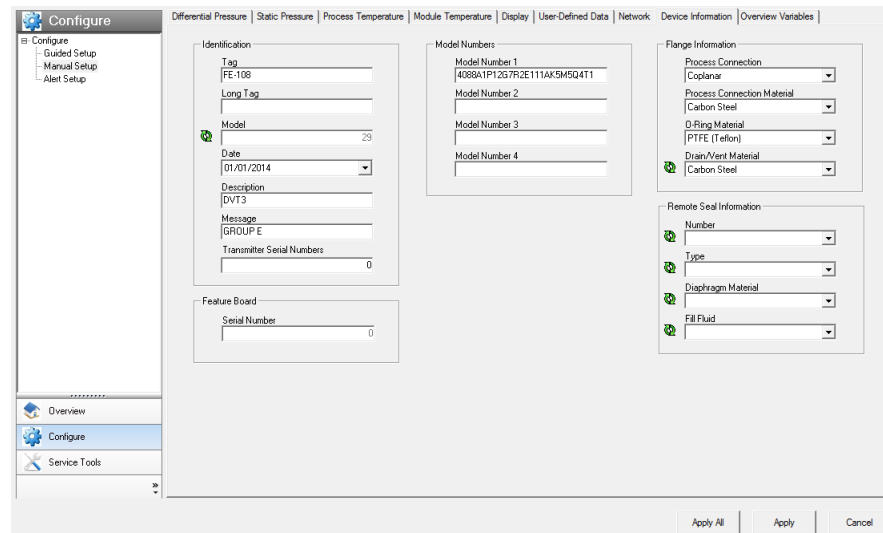

## 2.5.3 Overview variables

<b>Fast Keys</b>	2, 2, 8
------------------	---------

The *Overview Variables* tab allows the user to set which variables are displayed on the *RTIS Overview* screen.

Figure 2-6. Overview Variables Tab

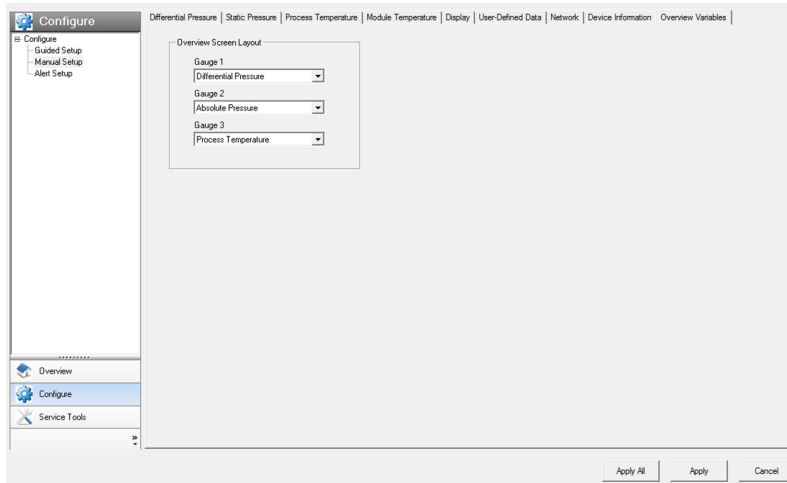

## 2.5.4 Alert setup

<b>Fast Keys</b>	2, 3
------------------	------

The *Alert Configuration* tab is found under the *Alert Setup* menu of the device's configuration menu. From this tab, the user can configure upper and lower alert levels for each of the measured variables. This includes the Differential Pressure, Static Pressure (Absolute or Gage), Module Temperature, or Process Temperature.

Figure 2-7. Alert Configuration Tab

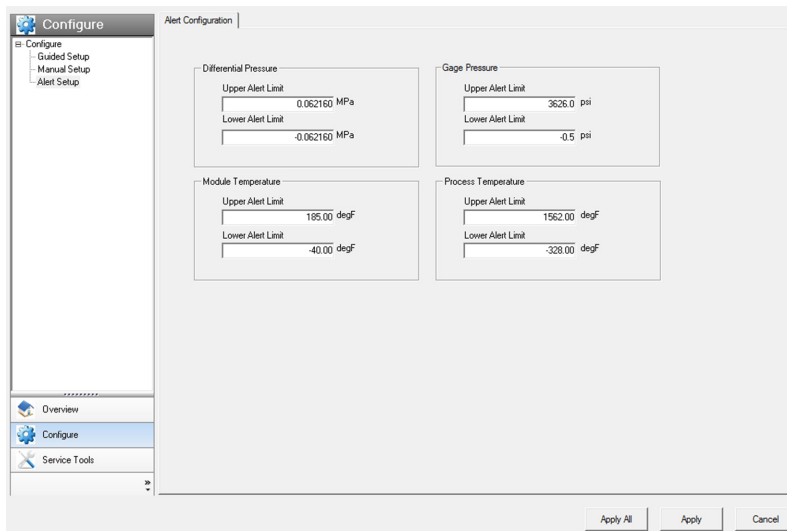

## 2.6 Variable configuration

### 2.6.1 Differential pressure

<b>Fast Keys</b>	2, 2, 1
------------------	---------

**Note**

For Differential pressure sensor calibration , see page 106.

**Figure 2-8. Differential Pressure Tab**

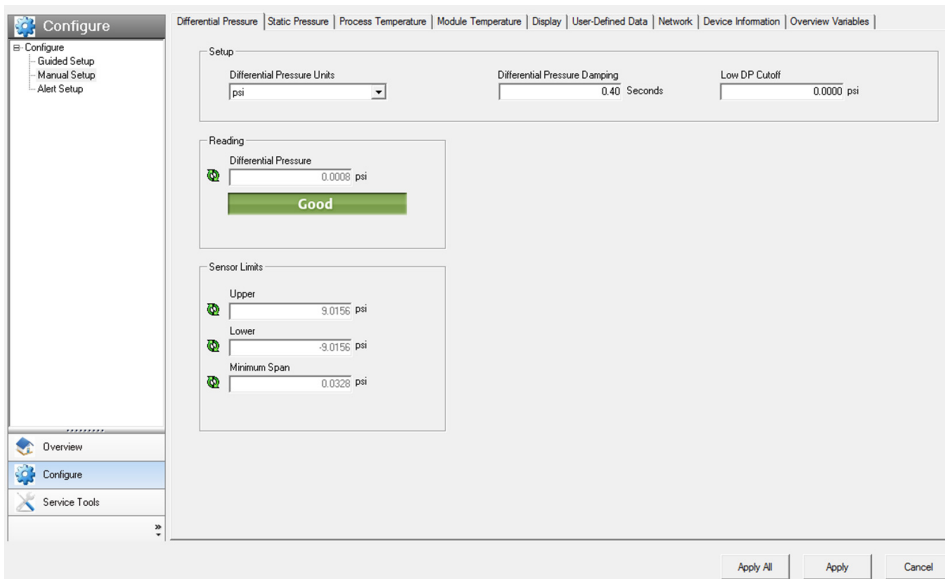

1. Under the *Setup* heading, edit the Units, Damping, and Low DP Cutoff as needed.
2. Under the *Reading* heading, view the Differential Pressure and status.
3. Under the *Sensor Limits* heading, view the Upper, Lower, and Minimum Span.

### 2.6.2 Static pressure

<b>Fast Keys</b>	2, 2, 2
------------------	---------

**Note**

For Static pressure sensor calibration , see page 109.

Figure 2-9. Static Pressure Tab

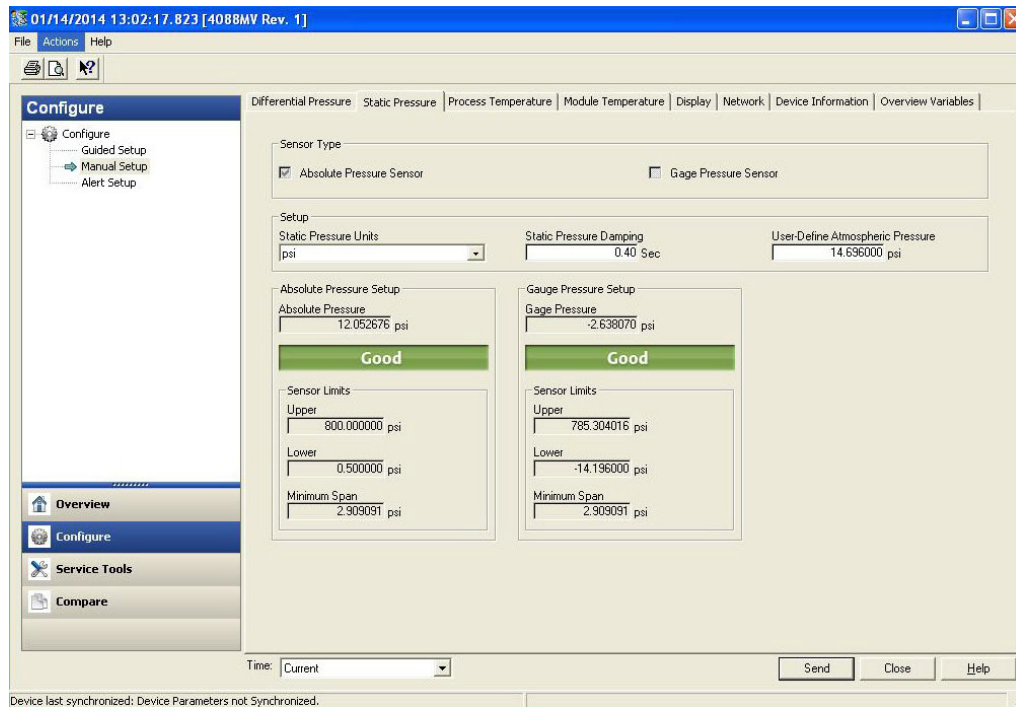

1. Under the *Sensor Type* heading, view whether the sensor is an Absolute Pressure Sensor or a Gage Pressure Sensor.
2. Under the *Setup* heading for Static Pressure, edit the Units, Damping, and User-Defined Atmospheric Pressure as needed.
3. Under the *Absolute Pressure Setup* and *Gage Pressure Setup* heading, view the Pressure, Status, Upper, Lower, and Minimum Span for both Absolute and Gage Pressure respectively.

### 2.6.3 Process temperature

<b>Fast Keys</b>	2, 2, 3
------------------	---------

**Note**

For Process temperature sensor calibration , see page 109.

Figure 2-10. Process Temperature Tab

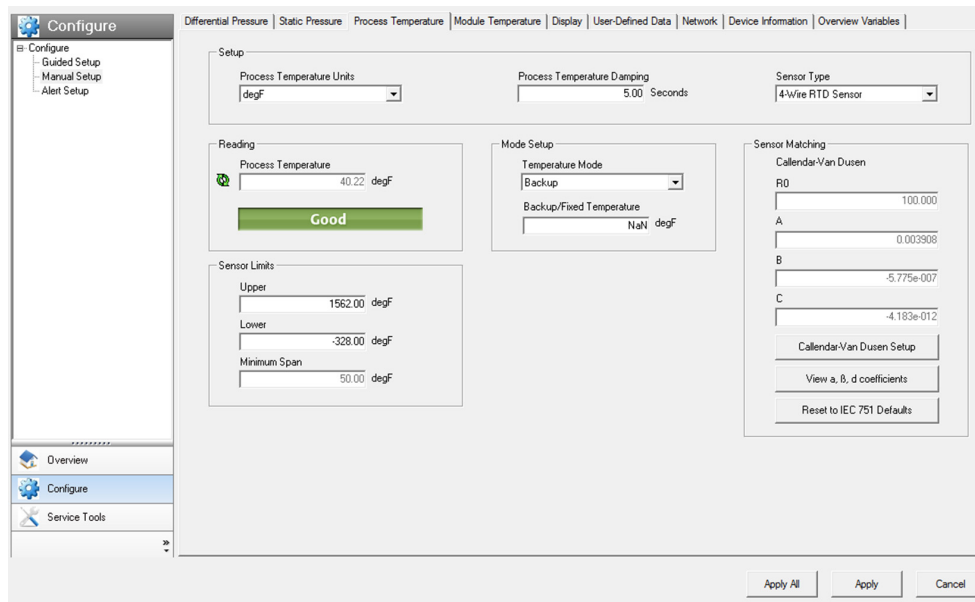

1. Under the *Setup* heading for Process Temperature, edit the Units, Damping, and Sensor Type as needed.

**Note**

The Rosemount 4088 accepts either a 3-wire or 4-wire RTD sensor, which can be selected under Sensor Type. Ensure the type of sensor being used is selected or an RTD Sensor Type Mismatch will occur. For more information about wiring the RTD, see “[Install optional process temperature input \(Pt 100 RTD Sensor\)](#)” on page 47.

2. Under the *Reading* heading, view the Process Temperature and status.
3. Select the **Temperature Mode** under the *Mode Setup* heading. See [Table 2-1](#) for mode types and descriptions.

Table 2-1. Temperature Modes

Temperature mode	Description
Normal	The transmitter will only use the actual measured Process Temperature value. If the temperature sensor fails, the transmitter process temperature will be NAN (not a number).
Backup	The transmitter will use the actual measured Process Temperature value. If the temperature sensor fails, the transmitter will use the value shown in the Fixed/Backup Temperature field.
Fixed	The transmitter will always use the temperature value shown in the Fixed/Backup Temperature field.

The Rosemount 4088 accepts Callendar-Van Dusen constants from a calibrated RTD schedule and generates a special custom curve to match that specific sensor resistance vs. temperature performance.

Matching the specific sensor curve with the transmitter configuration enhances the temperature measurement accuracy.

4. Under the *Sensor Matching* heading, view the Callendar-Van Dusen constants R0, A, B, and C. If the Callendar-Van Dusen constants are known for the user's specific Pt 100 RTD sensor, the constants R0, A, B, and C may be edited by selecting the **Callendar-Van Dusen Setup** button and following the on-screen prompts.

The user may also view the  $\alpha$ ,  $\beta$ , and  $d$  coefficients by selecting the **View Alpha, Beta, Delta** button. The constants R0,  $\alpha$ ,  $\beta$ , and  $d$  may be edited by selecting the **Callendar-Van Dusen Setup** button and following the on-screen prompts. To reset the transmitter to the IEC 751 Defaults, select the **Reset to IEC 751 Defaults** button.

5. Under the *Process Temperature Sensor Limits* heading, view and edit the Upper and Lower Sensor Limits. Process Temperature Sensor Limits allow for early detection of RTD failures or abnormal process conditions.

## 2.6.4 Module temperature

<b>Fast Keys</b>	2, 2, 4
------------------	---------

The sensor module temperature variable is the measured temperature of the sensors and electronics within the sensor module assembly. The module temperature value can be used to control heat tracing or diagnose device overheating.

**Figure 2-11. Module Temperature Tab**

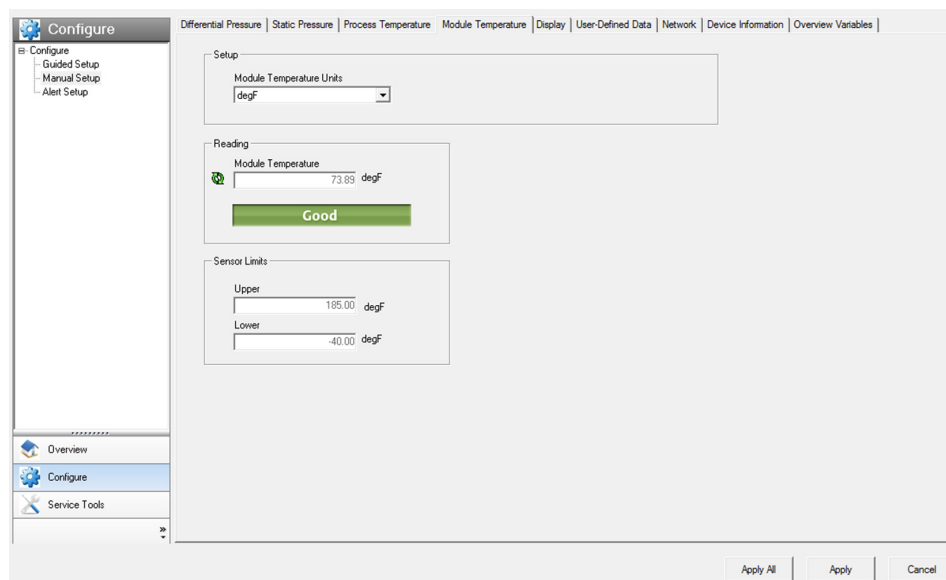

1. Under the *Setup* heading, edit the Units as needed.
2. Under the *Reading* heading, view the Module Temperature and status.
3. After the *Sensor Limits* heading, view the Upper and Lower Module Temperature Limits.

## 2.7 Menu trees and Field Communicator

Based on the configuration ordered, some measurements (i.e. static pressure, process temperature) may not be available. Available measurements are determined by the Multivariable Type and Measurement Type codes ordered. See ordering information in the Product Data Sheet for more information.

The menu trees and Field Communicator in this section are shown for the following model code:

Measurement type 1 (differential pressure, static pressure [absolute], process temperature) with LCD display

The menu trees and Field Communicator for other model codes will vary.



## 2.7.1 Rosemount 4088A menu tree

Figure 2-12. Overview

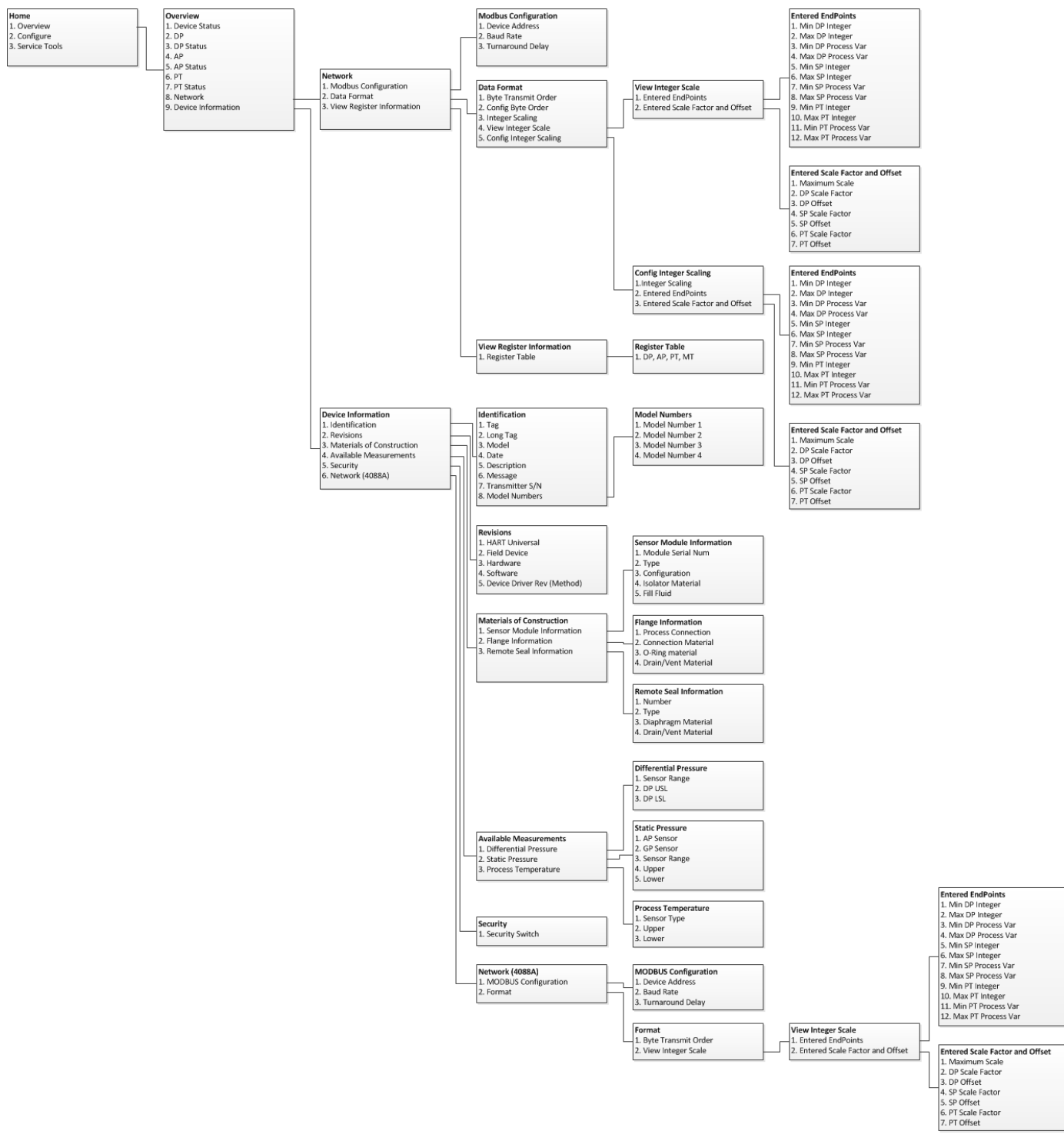

Figure 2-13. Configure – Guided Setup

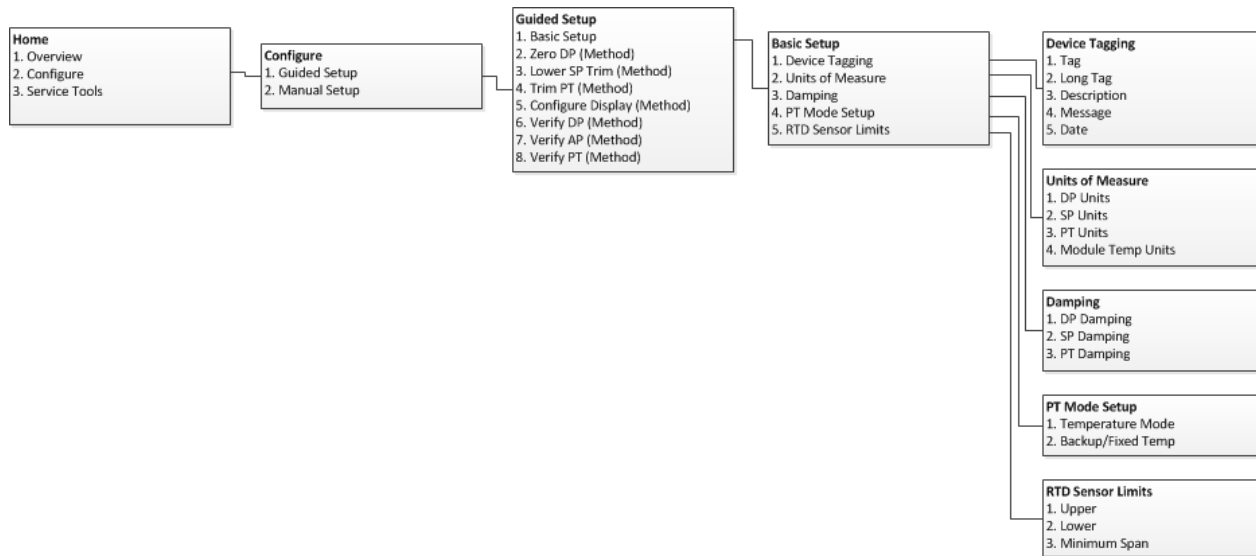

Figure 2-14. Configure – Manual Setup

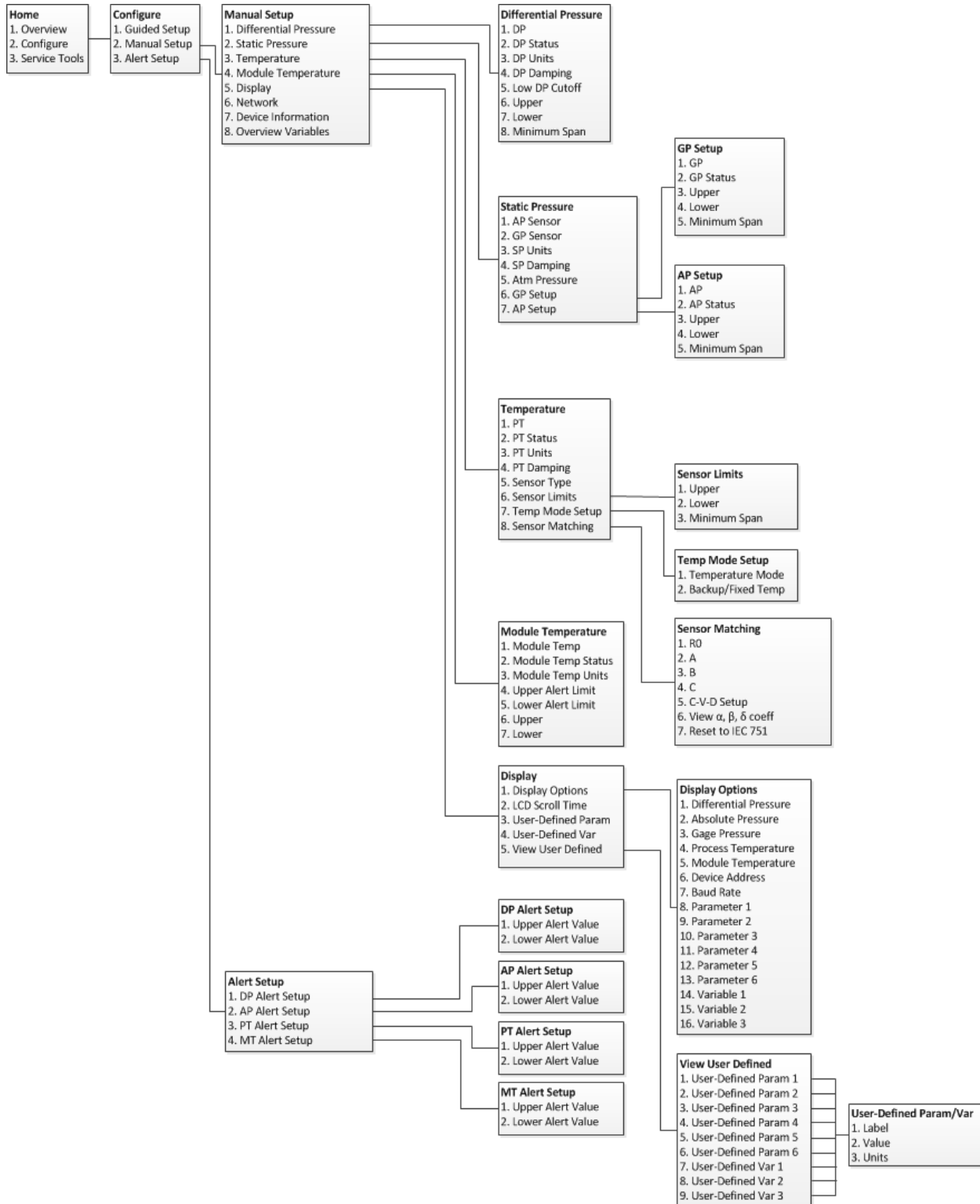

Figure 2-15. Configure – Manual Setup (Continued)

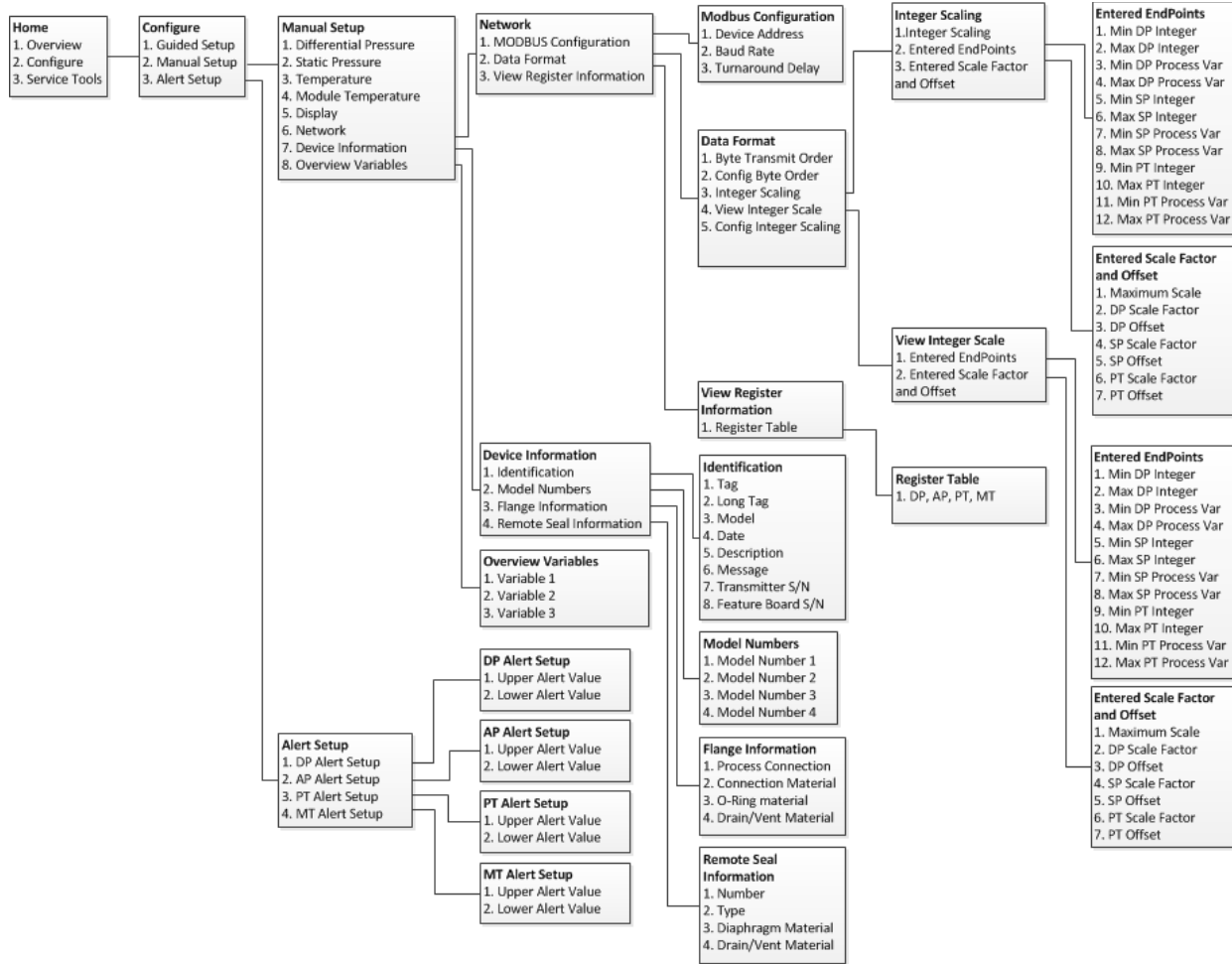

Figure 2-16. Service Tools

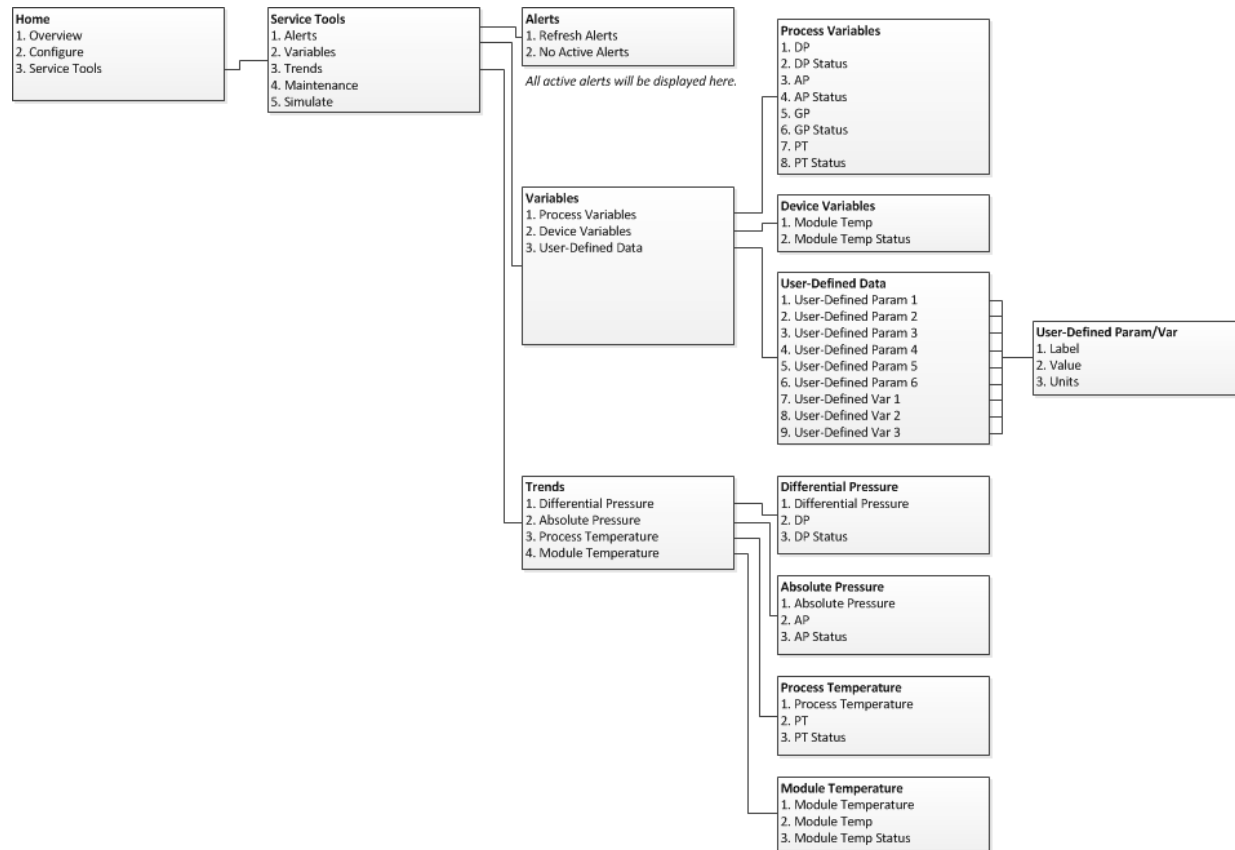
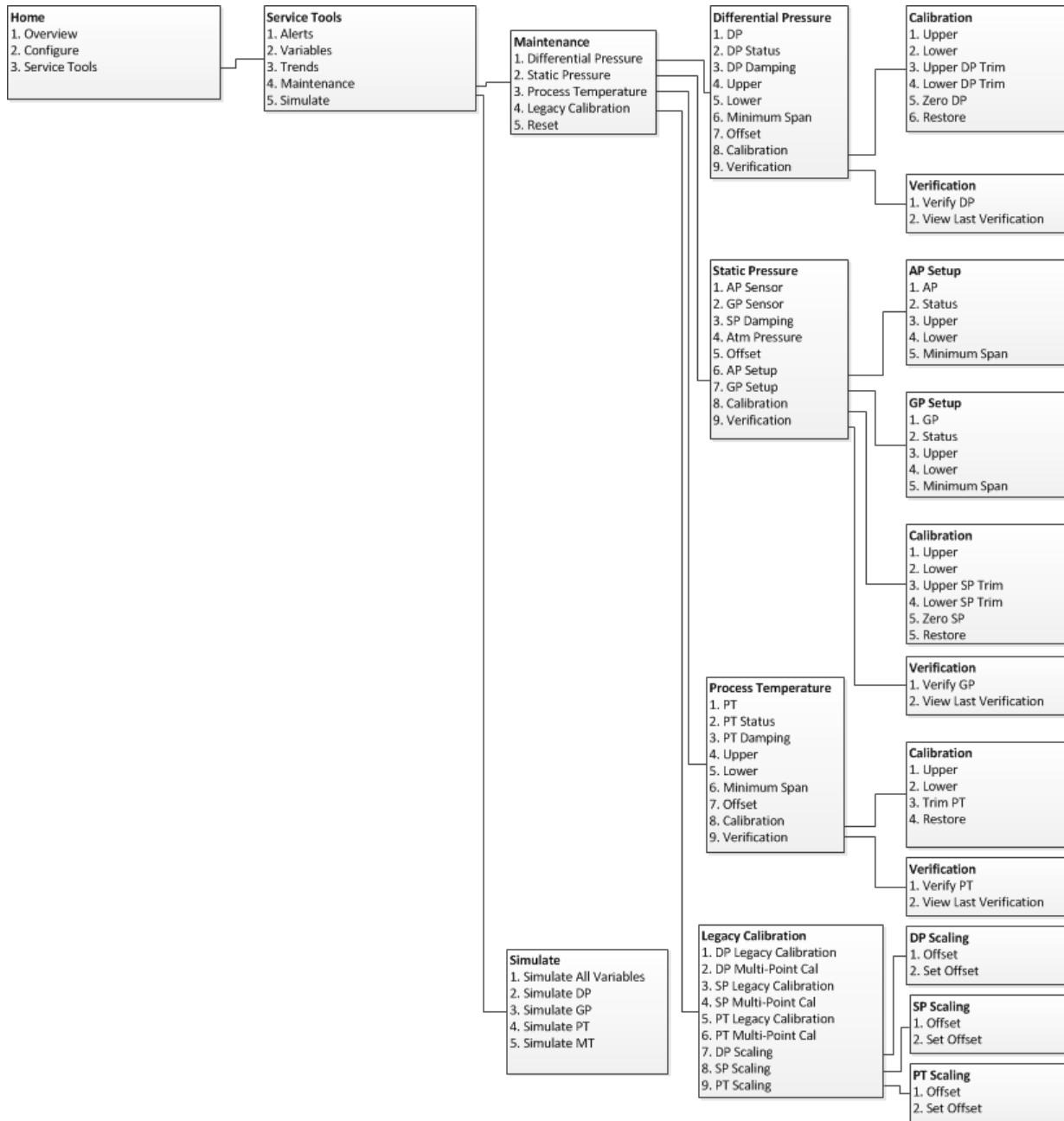

Figure 2-17. Service Tools (continued)



## 2.7.2 Rosemount 4088B menu tree

Figure 2-18. Overview

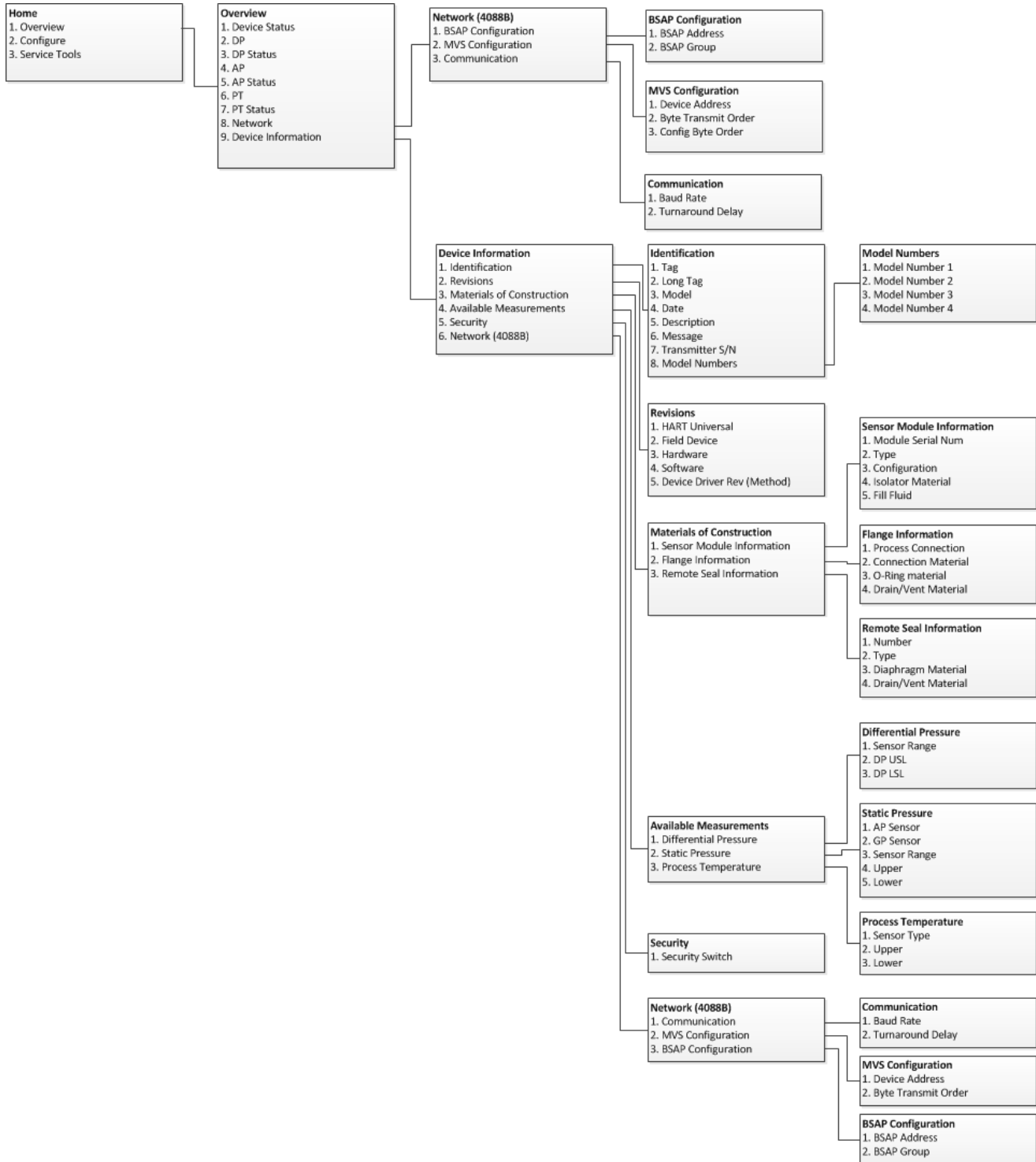

Figure 2-19. Configure – Guided Setup

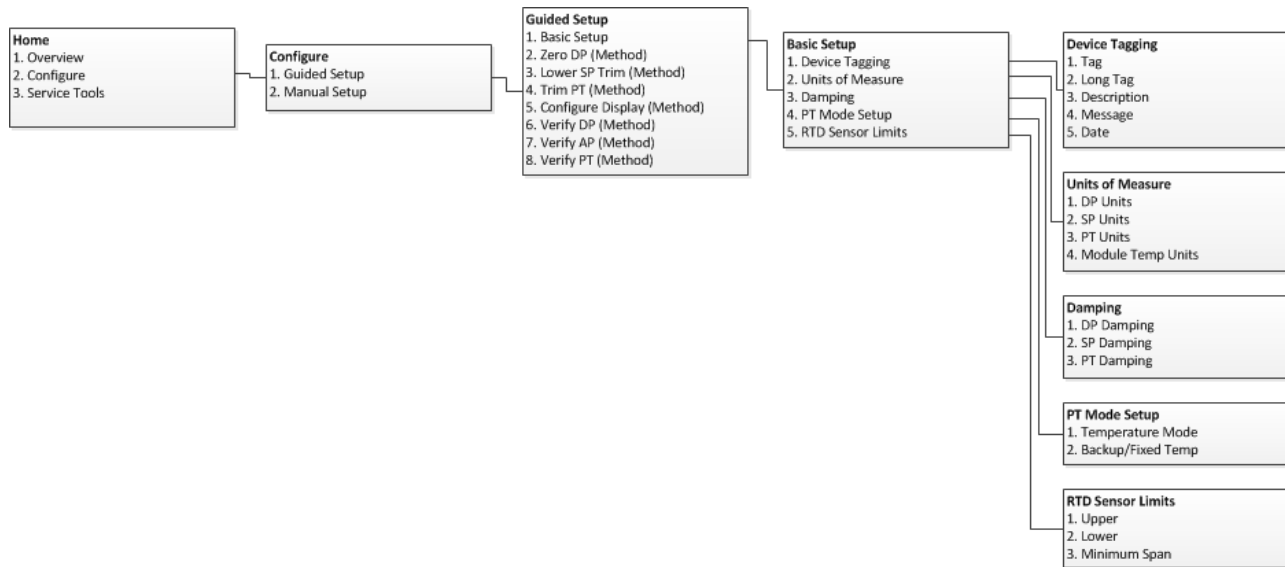



Figure 2-20. Configure – Manual Setup

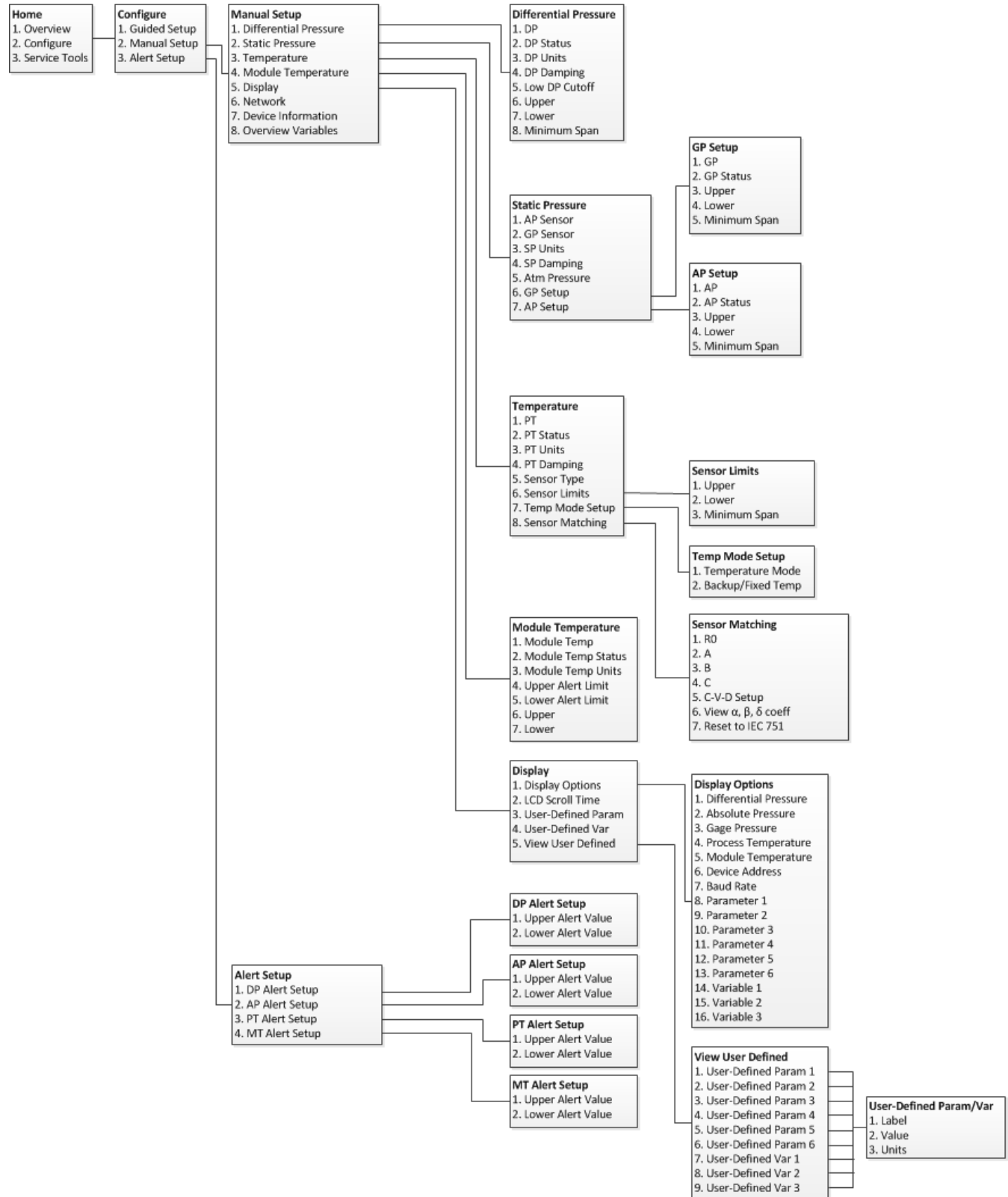

Figure 2-21. Configure – Manual Setup (Continued)

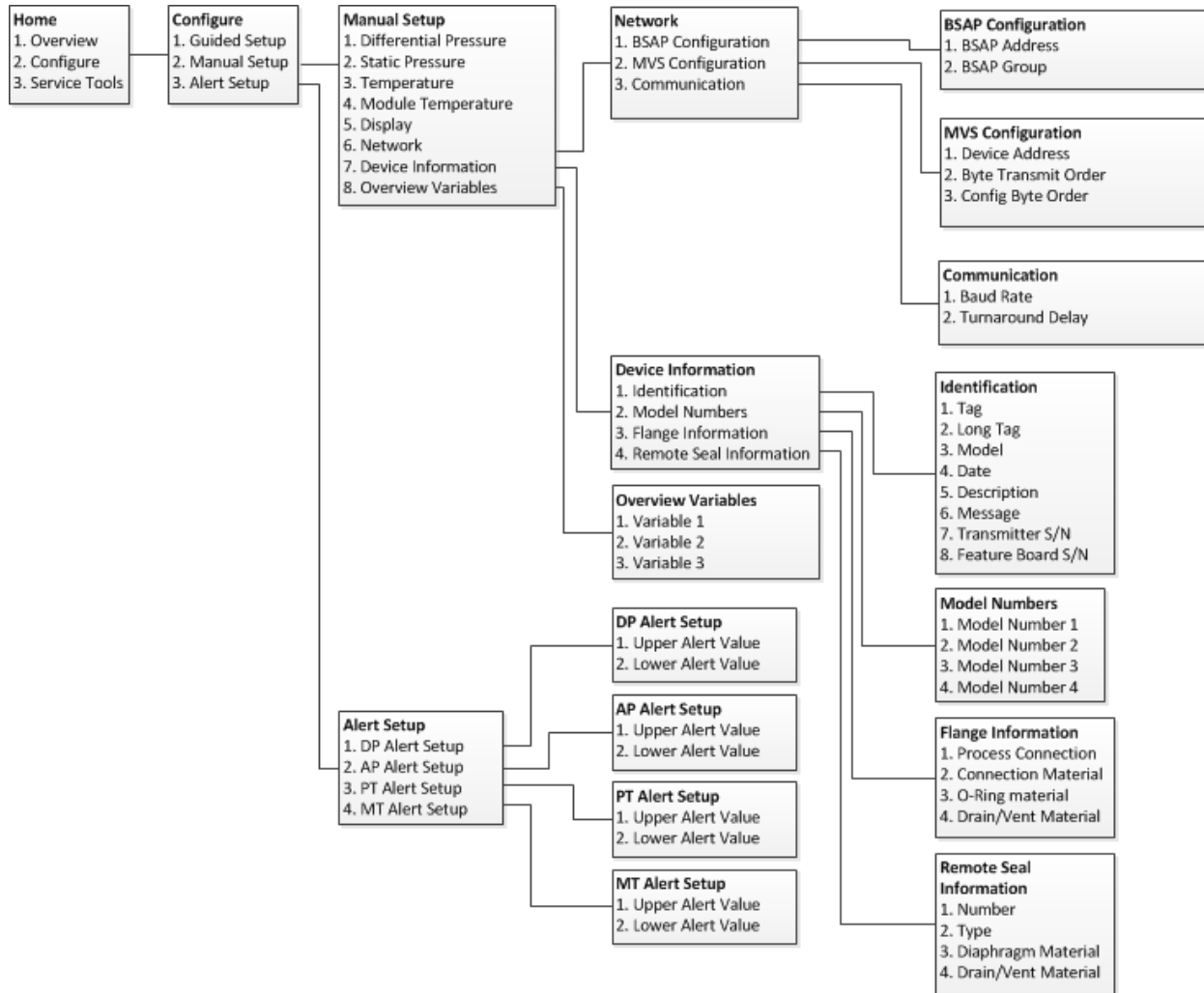

Figure 2-22. Service Tools

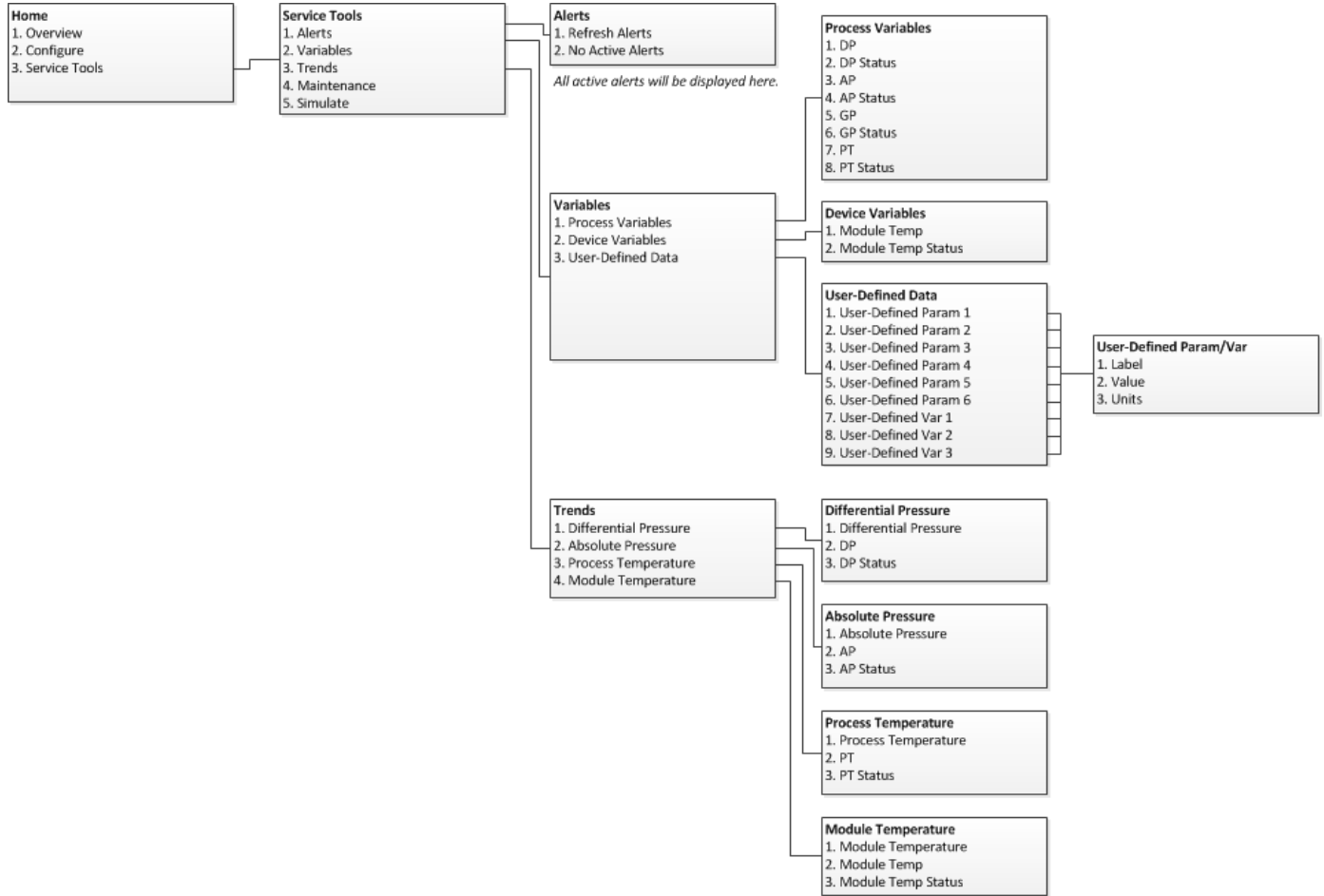
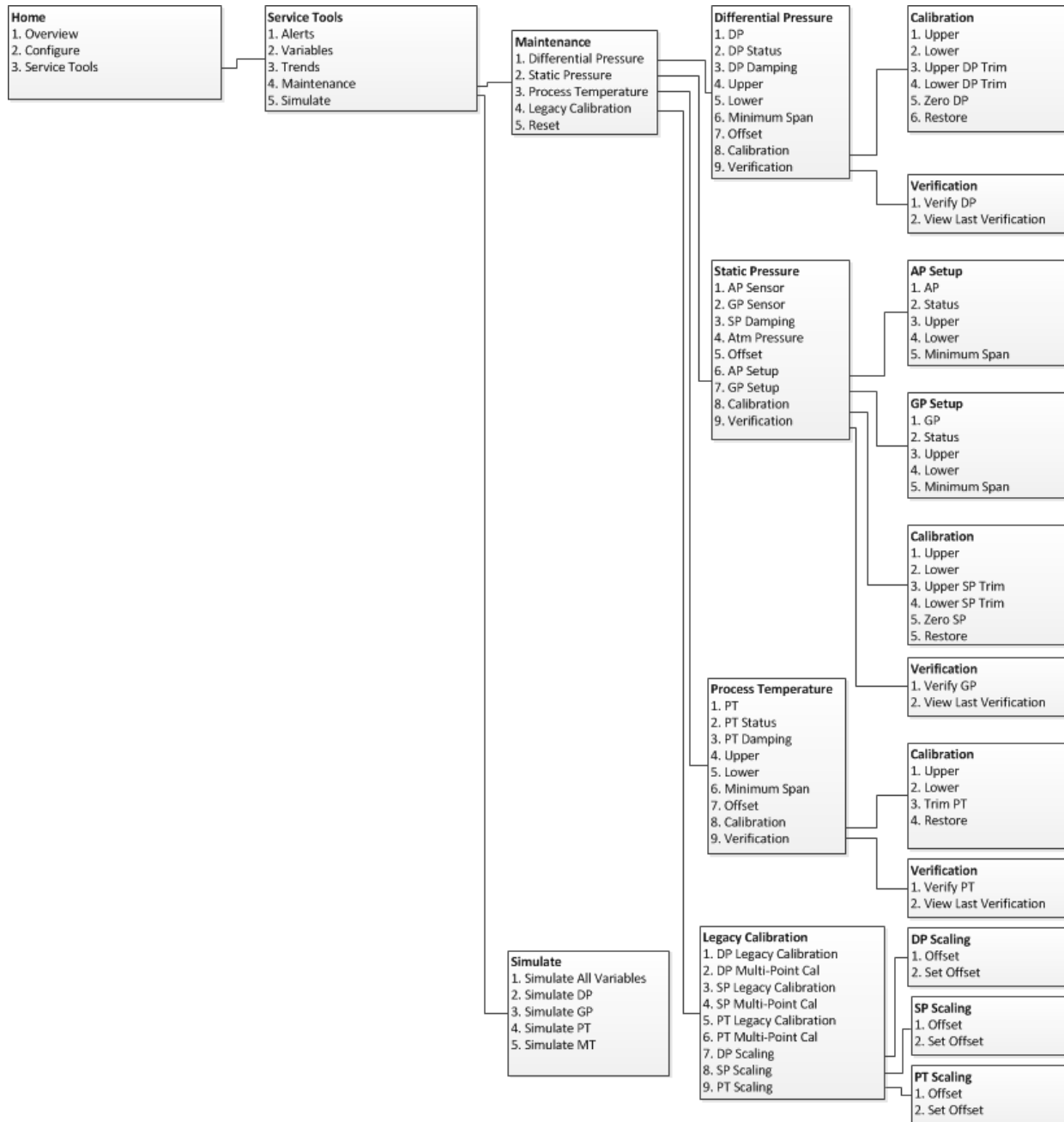

Figure 2-23. Service Tools (Continued)



## 2.7.3 Field Communicator

A check (✓) indicates the basic configuration parameters. At a minimum, these parameters should be verified as part of the configuration and startup procedure.

**Table 2-2. Field Communication Fast Keys**

	Category	Function	Sequence
✓	Device	Available Measurements	1, 9, 4
	Device	Display	2, 2, 5
	Device	Sensor Module Temperature	2, 2, 4
	Device	Sensor Module Temperature Units	2, 2, 4, 3
	Device	Sensor Module Temperature Upper Alert Limit	2, 2, 4, 4
	Device	Sensor Module Temperature Lower Alert Limit	2, 2, 4, 5
✓	Device	Device Address	2, 2, 6, 1, 1
	Device	Device Status	1, 1
	Device	Baud Rate	2, 2, 6, 1, 2
	Device	Turnaround Delay	2, 2, 6, 1, 3
	Device	Tag	2, 2, 7, 1, 1
	Device	Long Tag	2, 2, 7, 1, 2
	Device	Transmitter S/N	2, 2, 7, 1, 7
	Device	Security Switch	1, 9, 5, 1
	DP Sensor	DP	2, 2, 1
	DP Sensor	Calibration	3, 4, 1, 8
✓	DP Sensor	DP Units	2, 2, 1, 3
✓	DP Sensor	DP Damping	2, 2, 1, 4
	DP Sensor	Verification	3, 4, 1, 9
	DP Sensor	Upper Alert Limit	2, 2, 1, 6
	DP Sensor	Lower Alert Limit	2, 2, 1, 7
	PT Sensor	Sensor Matching	2, 2, 3, 8
	PT Sensor	PT	2, 2, 3
	PT Sensor	Calibration	3, 4, 3, 8
✓	PT Sensor	PT Units	2, 2, 3, 3
✓	PT Sensor	PT Damping	2, 2, 3, 4
✓	PT Sensor	Sensor Type	2, 2, 3, 5
	PT Sensor	Verification	3, 4, 3, 9
	PT Sensor	Upper Alert Limit	2, 2, 3, 6, 1
	PT Sensor	Lower Alert Limit	2, 2, 3, 6, 2
✓	PT Sensor	Temp Mode Setup	2, 2, 3, 7

**Table 2-2. Field Communication Fast Keys**

Category	Function	Sequence
SP Sensor	AP	2, 2, 2, 7
✓ SP Sensor	SP Units	2, 2, 2, 3
SP Sensor	GP	2, 2, 2, 6
✓ SP Sensor	SP Damping	2, 2, 2, 4
SP Sensor	Calibration	3, 4, 2, 8
SP Sensor	Verification	3, 4, 2, 9
SP Sensor	Upper Alert Limit	2, 2, 2, 6, 3
SP Sensor	Lower Alert Limit	2, 2, 2, 6, 4

## 2.8 Rosemount 4088A configuration with legacy tool

The Rosemount 4088A may be configured with the Rosemount 3095FB Configuration Software. When using this legacy tool, only functionality that was available with the Rosemount 3095FB can be accessed. The device must be removed from the Modbus network prior to communicating over the RS-485 bus.

**Figure 2-24. Transmitter Configuration via RS-485 Network Port**

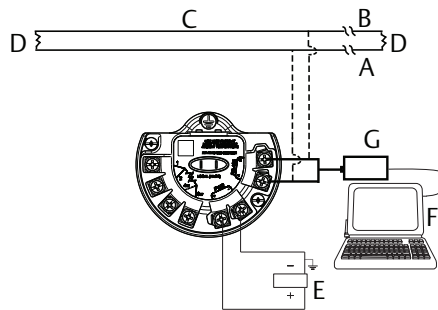

- A. RS-485 (A)
- B. RS-485 (B)
- C. RS-485 bus, twisted pair required
- D. Bus Termination: AC termination on Rosemount 4088 (see “Set the switches” on page 43) or 120 Ω resistor
- E. User-provided power supply
- F. Rosemount 3095FB configuration software
- G. RS 232/RS 485 converter

---

## Section 3 Installation

---

---

Overview .....	page 35
Safety messages .....	page 35
Considerations .....	page 36
Steps required for quick installation .....	page 37
Rosemount 305, 306, and 304 Manifolds .....	page 49

---

### 3.1 Overview

The information in this section covers installation considerations for the Rosemount™ 4088 MultiVariable™ Transmitter. The Rosemount 4088 [Quick Start Guide](#) is shipped with every transmitter to describe basic installation, wiring, and startup procedures. Dimensional drawings for each transmitter variation and mounting configuration are included in [Appendix A: Reference Data](#).

### 3.2 Safety messages

Procedures and instructions in this section may require special precautions to ensure the safety of the personnel performing the operation. Information that raises potential safety issues is indicated with a warning symbol (⚠). Refer to the following safety messages before performing an operation preceded by this symbol.

## ⚠ WARNING

### **Explosions can result in death or serious injury.**

- Do not remove the transmitter covers in explosive environments when the circuit is live.
- Fully engage both transmitter covers to meet explosion-proof requirements.
- Before connecting a communicator in an explosive atmosphere, make sure the instruments in the loop are installed in accordance with intrinsically safe or non-incendive field wiring practices.
- Verify the operating atmosphere of the transmitter is consistent with the appropriate hazardous locations certifications.

### **Electrical shock can result in death or serious injury.**

Avoid contact with the leads and terminals.

### **Process leaks could result in death or serious injury.**

- Install and tighten all four flange bolts before applying pressure.
- Do not attempt to loosen or remove flange bolts while the transmitter is in service.
- Replacement equipment or spare parts not approved by Emerson™ for use as spare parts could reduce the pressure retaining capabilities of the transmitter and may render the instrument dangerous.
- Use only bolts supplied or sold by Emerson as spare parts.

### **Improper assembly of manifolds to traditional flange can damage sensor module.**

For safe assembly of manifold to traditional flange, bolts must break back plane of flange web (i.e., bolt hole) but must not contact module housing.

### **Sensor module and electronics housing must have equivalent approval labeling in order to maintain hazardous location approvals.**

When upgrading, verify sensor module and electronics housing certifications are equivalent. Differences in temperature class ratings may exist, in which case the complete assembly takes the lowest of the individual component temperature classes (for example, a T4/T5 rated electronics housing assembled to a T4 rated sensor module is a T4 rated transmitter).

## 3.3 Considerations

### 3.3.1 General

Measurement performance depends upon proper installation of the transmitter and impulse piping. Mount the transmitter close to the process and use minimum piping to achieve best performance. Also, consider the need for easy access, personnel safety, practical field calibration, and a suitable transmitter environment. Install the transmitter to minimize vibration, shock, and temperature fluctuation.

#### **Important**

Install the enclosed pipe plug (found in the box) in the unused conduit opening. For straight threads, a minimum of six threads must be engaged. For tapered threads, install the plug wrench-tight.

For material compatibility considerations, see the Material Selection [Technical Note](#).



## 3.3.2 Mechanical

### Steam service

For steam service or for applications with process temperatures greater than the limits of the transmitter, do not blow down impulse piping through the transmitter. Flush lines with the blocking valves closed and refill lines with water before resuming measurement.

### Side mounting

When the transmitter is mounted on its side, position the coplanar flange to ensure proper venting or draining. Mount the flange as shown in [Figure 3-5 on page 41](#), keeping drain/vent connections on the bottom for gas service and on the top for liquid service.

## 3.3.3 Environmental

Best practice is to mount the transmitter in an environment that has minimal ambient temperature change. The transmitter electronics temperature operating limits are  $-40$  to  $185$  °F ( $-40$  to  $85$  °C). [Appendix A: Reference Data](#) lists the sensing element operating limits. Mount the transmitter so it is not susceptible to vibration and mechanical shock and does not have external contact with corrosive materials.

## 3.4 Steps required for quick installation

Start >

Mount the transmitter

Consider housing rotation

Set the switches

Wiring and power up

Verify device configuration

Trim the transmitter

> Finish

### 3.4.1 Mount the transmitter

#### Liquid flow applications

1. Place taps to the side of the line.
2. Mount beside or below the taps.
3. Mount the transmitter so that the drain/vent valves are oriented upward.

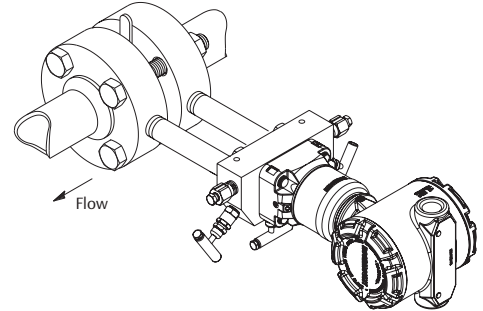

#### Gas flow applications

1. Place taps in the top or side of the line.
2. Mount beside or above the taps.

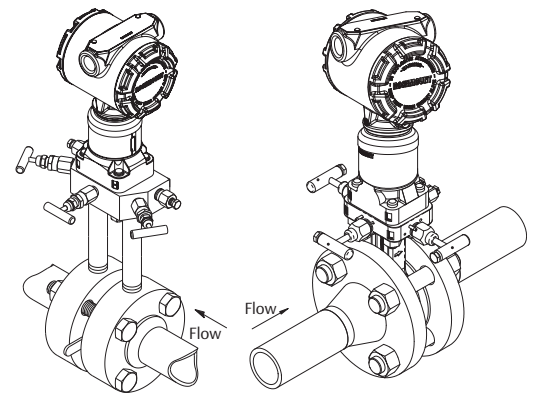

#### Steam flow applications

1. Place taps to the side of the line.
2. Mount beside or below the taps.
3. Fill impulse lines with water.

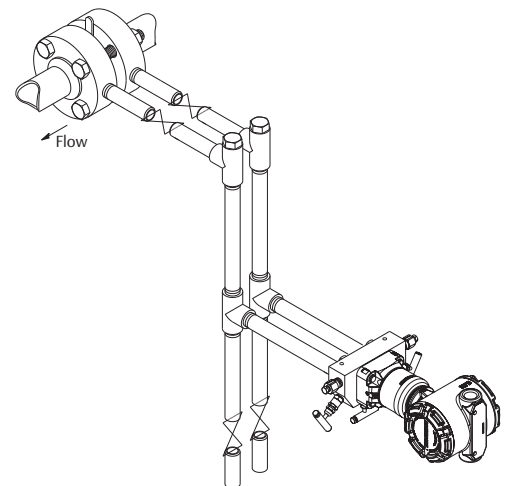

Figure 3-1. Mounting Bracket – Coplanar Flange

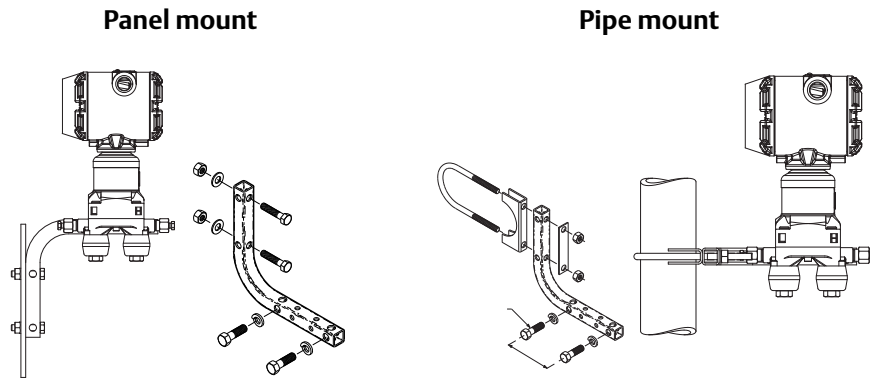

Figure 3-2. Mounting Brackets – Traditional Flange

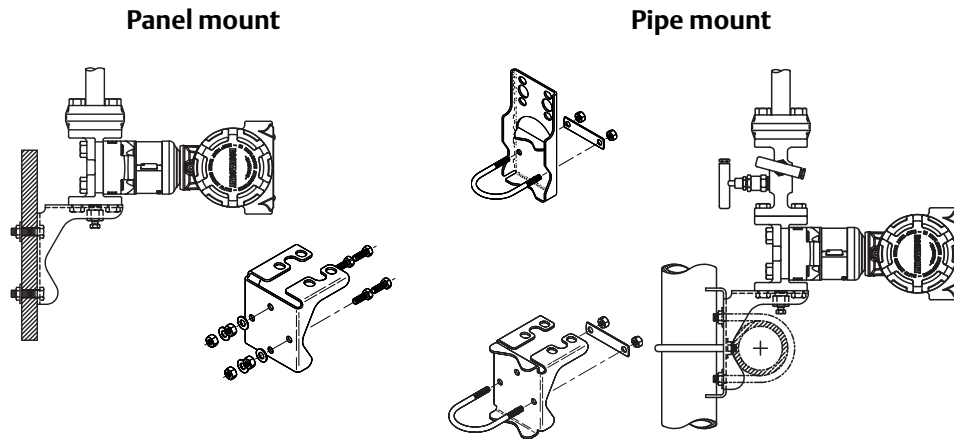
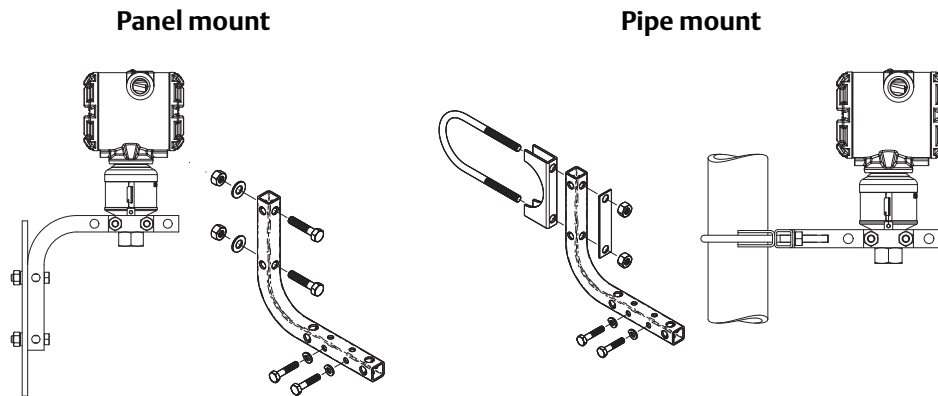

Figure 3-3. Mounting Brackets – In-line



## Bolting considerations

If the transmitter installation requires assembly of a process flange, manifold, or flange adapters, follow these assembly guidelines to ensure a tight seal for optimal performance characteristics of the transmitter. Only use bolts supplied with the transmitter or sold by Emerson as spare parts. [Figure 3-4](#) illustrates common transmitter assemblies with the bolt length required for proper transmitter assembly.

**Figure 3-4. Common Transmitter Assemblies**

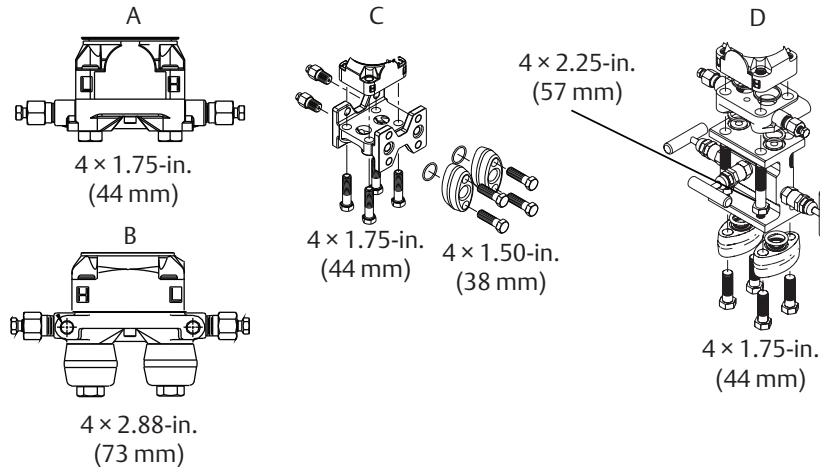

- A. Transmitter with coplanar flange
- B. Transmitter with coplanar flange and optional flange adapters
- C. Transmitter with traditional flange and optional flange adapters
- D. Transmitter with coplanar flange and optional manifold and flange adapters

### Note

For all other manifolds, contact Customer Central technical support.

Bolts are typically carbon steel or stainless steel. Confirm the material by viewing the markings on the head of the bolt and referencing [Table 3-1 on page 41](#). If bolt material is not shown in [Table 3-1](#), contact the local Emerson representative for more information.

Use the following bolt installation procedure:

1. Carbon steel bolts do not require lubrication and the stainless steel bolts are coated with a lubricant to ease installation. However, no additional lubricant should be applied when installing either type of bolt.
2. Finger-tighten the bolts.
3. Torque the bolts to the initial torque value using a crossing pattern. See [Table 3-1](#) for initial torque value.
4. Torque the bolts to the final torque value using the same crossing pattern. See [Table 3-1](#) for final torque value.
5. Verify the flange bolts are protruding through the sensor module before applying pressure (see [Figure 3-5 on page 41](#)).

**Table 3-1. Torque Values for the Flange and Flange Adapter Bolts**

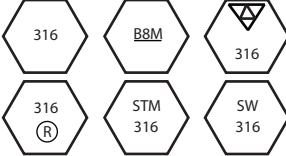
Bolt material	Head markings	Initial torque	Final torque
Carbon Steel (CS)		300 in-lb	650 in-lb
Stainless Steel (SST)		150 in-lb	300 in-lb

**Figure 3-5. Proper Bolt Installation**

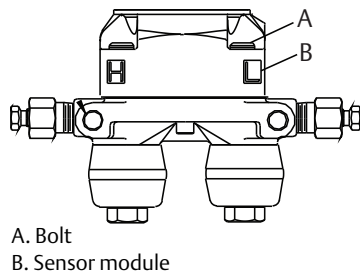

## O-rings with flange adapters

### ⚠ WARNING

Failure to install proper flange adapter O-rings may cause process leaks, which can result in death or serious injury. Only use the O-ring that is designed for its specific flange adapter.

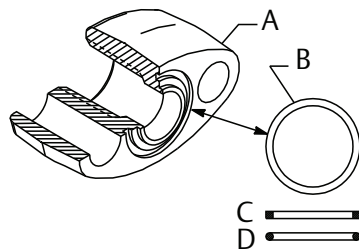

- A. Flange adapter
- B. O-ring
- C. PTFE-based profile (square)
- D. Elastomer profile (round)

Whenever the flange or adapters are removed, visually inspect the O-rings. Replace them if there are any signs of damage, such as nicks or cuts. If the O-rings are replaced, re-torque the flange bolts and alignment screws after installation to compensate for seating of the O-rings.

## In-line gage transmitter orientation

The low side pressure port (atmospheric reference) on the in-line gage transmitter is located under the sensor module neck label. (See [Figure 3-6 on page 42](#))

Keep the vent path free of any obstruction, including but not limited to paint, dust, and lubrication by mounting the transmitter so that any contaminants can drain away.

Figure 3-6. In-line Gage Transmitter

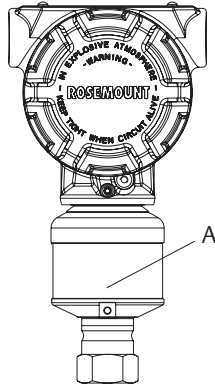

A. Low side pressure port (under neck label)

### 3.4.2 Consider housing rotation

To improve field access to wiring or to better view the optional LCD display:

1. Loosen the housing rotation set screw.
2. Turn the housing up to 180° left or right of its original (as shipped) position.
3. Re-tighten the housing rotation set screw.

Figure 3-7. Transmitter Housing Set Screw

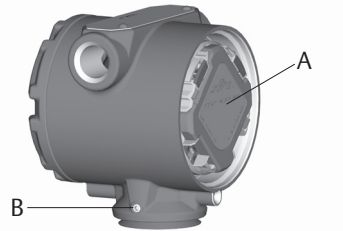

A. LCD display  
B. Housing rotation set screw ( $\frac{3}{32}$ -in.)

#### Note

Do not rotate the housing more than 180° without first performing a disassembly procedure (refer to [Section 6: Troubleshooting](#) for more information). Over-rotation may sever the electrical connection between the sensor module and the electronics.

### Rotate the LCD display

Transmitters ordered with the LCD display will be shipped with the display installed.

In addition to housing rotation, the optional LCD display can be rotated in 90° increments by squeezing the two tabs, pulling out, rotating and snapping back into place.

If LCD display pins are inadvertently removed from the electronics board, carefully re-insert the pins before snapping the LCD display back into place.

Use the following procedure and [Figure 3-8 on page 43](#) to install the LCD display:

1. If the transmitter is installed in a loop, then secure the loop and disconnect power.
- ⚠️ 2. Remove the transmitter cover on the electronics board side (opposite the field terminals side). Do not remove instrument covers in explosive environments when circuit is live.
3. Engage the four-pin connector into the electronics board and snap LCD display into place.
- ⚠️ 4. In order to meet explosion-proof requirements, reinstall the housing cover and tighten so the cover is fully seated with metal to metal contact between the housing and cover. After the cover is seated properly, replace the flathead screw located on the bottom of the housing cover.

Figure 3-8. Optional LCD Display

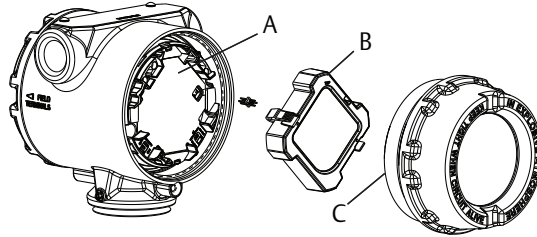

- A. Electronics board
- B. LCD display
- C. Display cover

### 3.4.3 Set the switches

The transmitter's default configuration for the AC Termination is in the *off* position. The transmitter's electronics board default configuration for the Security switch is in the *off* position.

1. If the transmitter is installed, secure the bus and remove power.
- ⚠️ 2. Remove the transmitter cover opposite the field terminal side. Do not remove the instrument covers in explosive environments when the circuit is live.
3. Slide the Security and AC Termination switches into the preferred position by using a small screwdriver.

#### Note

The Security switch will need to be in the off position in order to make any configuration changes.

- ⚠️ 4. In order to meet explosion-proof requirements, reinstall the housing cover and tighten so the cover is fully seated with metal to metal contact between the housing and cover. After the cover is seated properly, replace the flathead screw located on the bottom of the housing cover.

Figure 3-9. Transmitter Switch Configuration



- A. Security
- B. AC termination

## 3.4.4 Wiring and power up

Use the following steps to wire the transmitter:

1. Remove the cover on the field terminals side of the housing.
2. Set up based on optional process temperature input.
  - a. If the optional process temperature input is being utilized, follow the procedure “[Install optional process temperature input \(Pt 100 RTD Sensor\)](#)” on page 47.
  - b. If there will not be an optional process temperature input, plug and seal the unused conduit connection.



### Note

When the enclosed threaded plug is utilized in the conduit opening, it must be installed with a minimum engagement of five threads in order to comply with explosion-proof requirements. For straight threads, a minimum of six threads must be engaged. For tapered threads, install the plug wrench-tight.

3. Connect the Rosemount 4088A to the RS-485 bus as shown in [Figure 3-10](#) (for Rosemount 4088B wiring and power up instructions, reference the ROC and FloBoss Manuals outlined in “[Rosemount 4088B ROC communications](#)” on page 77 or the ControlWave Manual outlined in “[Rosemount 4088B BSAP communications](#)”).
  - a. Connect the A lead to the “A” terminal.
  - b. Connect the B lead to the “B” terminal.
4. Connect the positive lead from the power source to the “PWR +” terminal, and the negative lead to the “PWR –” terminal (for power requirements, reference the Product Data Sheet).

---

### Note

The Rosemount 4088A uses RS-485 Modbus® with eight data bits, one stop bit and no parity. The default baud rate is 9600.

---

### Note

Twisted pair wiring is required for RS-485 bus wiring. Wiring runs under 1000 ft (305 m) should be AWG 22 or larger. Wiring runs from 1000 to 4000 ft. (305 to 1219 m) should be AWG 20 or larger. Wiring should not exceed AWG 16.



5. Reinstall the housing cover and tighten so the cover is fully seated with metal to metal contact between the housing and cover in order to meet explosion-proof requirements.

---

### Note

Installation of the transient protection terminal block does not provide transient protection unless the transmitter housing is properly grounded.

---



## Transmitter wiring

Figure 3-10. Transmitter Wiring for RS-485 Bus

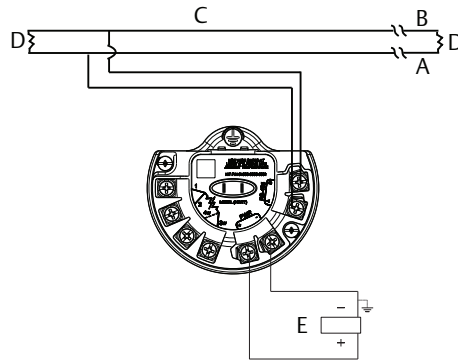

- A. RS-485 (A)
- B. RS-485 (B)
- C. RS-485 bus, twisted pair required
- D. Bus Termination: AC Termination on Rosemount 4088 (see "Set the switches" on page 43) or 120  $\Omega$  resistor
- E. User-provided power supply

To configure transmitter via HART® port, reference Figure 2-1 on page 7 for the wiring diagram.

To configure using RS-485 network port, reference Figure 2-24 on page 34 for the wiring diagram.

## Grounding

### Signal wire grounding

Do not run signal wiring in conduit or open trays with power wiring, or near heavy electrical equipment. If shielded wiring is used, ground the shield of the signal wiring at any one point on the signal loop. Device must be properly grounded or earthed according to local electric codes.

### Transmitter case

Always ground the transmitter case in accordance with national and local electrical codes. The most effective transmitter case grounding method is a direct connection to earth ground with minimal impedance ( $< 1 \Omega$ ). Methods for grounding the transmitter case include:

#### Internal ground connection

The internal ground connection screw is inside the terminal side of the electronics housing. The screw is identified by a ground symbol ( $\perp$ ).

Figure 3-11. Internal Ground Connection

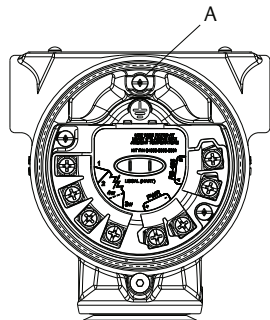

- A. Ground lug

### External ground connection

The external ground connection is on the outside of the sensor module housing. The connection is identified by a ground symbol (⊕). An external ground assembly is included with the option codes shown in [Table 3-2 on page 46](#) or is available as a spare part (03151-9060-0001).

**Figure 3-12. External Ground Connection**

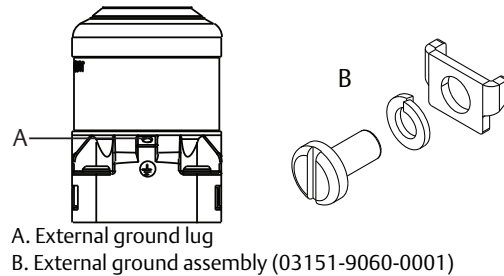

**Table 3-2. External Ground Screw Approval Option Codes**

Option code	Description
E1	ATEX Flameproof
I1	ATEX Intrinsic Safety
N1	ATEX Type n
ND	ATEX Dust
K1	ATEX Flameproof, Intrinsic Safety, Type n, Dust (combination of E1, I1, N1, and ND)
E7	IECEX Flameproof, Dust Ignition-proof
N7	IECEX Type n
K7	IECEX Flameproof, Dust Ignition-proof, Intrinsic Safety, and Type n (combination of E7, I7, and N7)
KA	ATEX and CSA Explosion-proof, Intrinsically Safe, Division 2 (combination of E1, E6, I1, and I6)
KC	FM and ATEX Explosion-proof, Intrinsically Safe, Division 2 (combination of E5, E1, I5, and I1)
T1	Transient terminal block
D4	External ground screw assembly

### Surges/transients

The transmitter will withstand electrical transients of the energy level usually encountered in static discharges or induced switching transients. However, high-energy transients, such as those induced in wiring from nearby lightning strikes, can damage the transmitter.

### Optional transient protection terminal block

The transient protection terminal block can be ordered as an installed option (option code T1 in the transmitter model number) or as a spare part to retrofit existing Rosemount 4088 MultiVariable Transmitters in the field. For a complete listing of spare part numbers for transient protection terminal blocks, refer to [“Spare parts list” on page 123](#). A lightning bolt symbol on a terminal block identifies it as having transient protection.

---

**Note**

Grounding the transmitter case using the threaded conduit connection may not provide a sufficient ground. The transient protection terminal block (option code T1) will not provide transient protection unless the transmitter case is properly grounded. See “[Grounding](#)” on [page 45](#) to ground the transmitter case. Do not run transient protection ground wire with signal wiring; the ground wire may carry excessive current if a lightning strike occurs.

---

**Optional extended cover**

The Rosemount 4088 can also be ordered with an aluminum or SST extended cover. The extended cover option is beneficial in applications where more space is needed to wire the transmitter. The extended cover can be ordered as an installed option (option code HX under housing cover extension) or as a spare part to retrofit existing Rosemount 4088 MultiVariable Transmitters in the field. For a complete list of the spare part numbers for covers, refer to “[Spare parts list](#)” on [page 123](#).

**Install optional process temperature input  
(Pt 100 RTD Sensor)**

---

**Note**

To meet ATEX/IECEX Flameproof certification, only ATEX/IECEX Flameproof cables (temperature input code C30, C32, C33, or C34) may be used.

---

1. Mount the Pt 100 RTD Sensor in the appropriate location.
- 

**Note**

Use shielded 4- or 3-wire cable for the process temperature connection.

---

2. Connect the RTD cable to the transmitter by inserting the cable wires through the unused housing conduit and connect to the screws on the transmitter terminal block. An appropriate cable gland should be used to seal the conduit opening around the cable.
- 

**Note**

If power is already connected to the Rosemount 4088, power should be removed prior to connecting the RTD wires. This will allow the Rosemount 4088 to detect the RTD type at startup. Once the RTD is installed, reconnect power.

---

3. Connect the RTD cable shield wire to the ground lug in the housing.

**Figure 3-13. Transmitter RTD Wiring Connection**

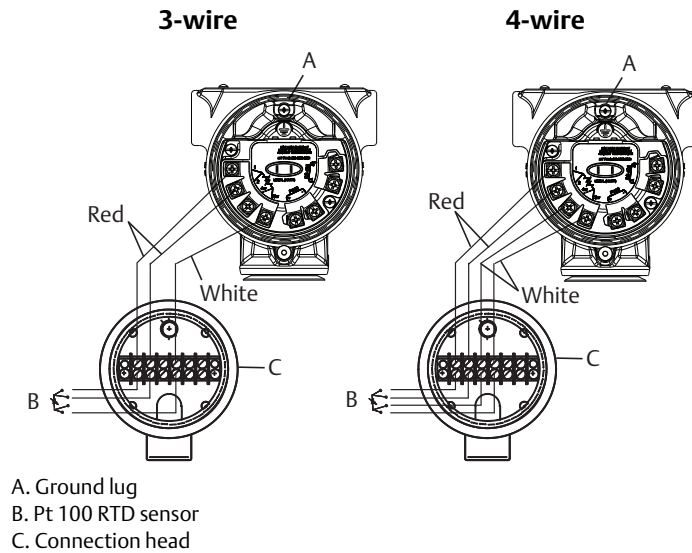

**Note**

Verify the installed PT sensor type (3-wire or 4-wire) matches the device setting.

### 3.4.5 Verify device configuration

For Rosemount 4088A, use Rosemount Transmitter Interface Software with the Rosemount 4088 DTM or a HART Field Communicator with the Rosemount 4088 Device Descriptor to communicate with and verify configuration of the transmitter.

For Rosemount 4088B, use ROCLINK™, TechView, or HART Field Communicator to communicate with and verify configuration of the transmitter.

**Note**

A list of parameters to verify during commissioning is listed in “Field Communicator” on page 33.

### 3.4.6 Trim the transmitter

Transmitters are shipped fully calibrated per request or by the factory default.

#### Zero trim

A zero trim is a single-point adjustment used for compensating mounting position and line pressure effects on static and differential pressure sensors. When performing a zero trim, ensure that the equalizing valve is open and all wet legs are filled to the correct level.

If zero offset is less than 5 percent of USL, follow the user interface software instructions below to perform a zero trim on a Field Communicator or see the “Zero trim” on page 105 for PC configuration.

#### Performing a zero trim using the Field Communicator

1. Block, equalize, and vent the transmitter and connect the Field Communicator (for more information on connecting the Field Communicator, see Figure 2-1 on page 7).
2. If the device is equipped with a static pressure sensor, trim the sensor by inputting the following Fast

Key sequence at the transmitter menu:

<b>Field Communicator</b>	3, 4, 2, 8
---------------------------	------------

3. Follow the appropriate static pressure trim procedure.
  - Zero trim for gage pressure sensors

or

  - Lower sensor trim for absolute pressure sensors

---

**Note**

It is possible to degrade the performance of the transmitter if the full sensor trim is done improperly or with inaccurate calibration equipment. Use a pressure input source that is at least three times more accurate than the transmitter and allow the pressure input to stabilize for ten seconds before entering any values.

4. Zero the differential pressure sensor by inputting the following Fast Key sequence at the transmitter menu:

<b>Field Communicator</b>	3, 4, 1, 8, 5
---------------------------	---------------

5. Follow the zero DP trim procedure.

## 3.5 Rosemount 305, 306, and 304 Manifolds

The Rosemount 305 Integral Manifold mounts directly to the transmitter and is available in two styles: traditional and coplanar. The traditional Rosemount 305 can be mounted to most primary elements in the market today using mounting adapters.

The Rosemount 306 Integral Manifold is used with in-line transmitters to provide block-and-bleed valve capabilities of up to 10000 psi (690 bar).

The Rosemount 304 conventional manifold combines a traditional flange and manifold that can be mounted to most primary elements.

### 3.5.1 Rosemount 305 Integral Manifold installation procedure

To install a Rosemount 305 to a Rosemount 4088:

- ⚠ 1. Inspect the PTFE sensor module O-rings. If the O-rings are undamaged, reusing them is recommended. If the O-rings are damaged (if they have nicks or cuts, for example), replace them with new O-rings.

---

**Important**

If replacing the O-rings, be careful not to scratch or deface the O-ring grooves or the surface of the isolating diaphragm when removing the damaged O-rings.

2. Install the integral manifold on the sensor module. Finger tighten the bolts, then tighten the bolts incrementally in a cross pattern (see [Figure 3-14](#)) to final torque value. See [Table 6-4 on page 122](#) for complete bolt installation information and for torque values. When fully tightened, the bolts should extend through the top of the module housing plane of the flange web (i.e. bolt hole) but must not contact the module housing.

3. If the PTFE sensor module O-rings have been replaced, the flange bolts should be re-tightened after installation to compensate for cold flow of the O-rings.
4. If applicable, install flange adapters on the process end of the manifold using the 1.75-in. flange bolts supplied with the transmitter.

---

**Note**

Always perform a zero trim on the transmitter/manifold assembly after installation to eliminate mounting effects. See “Zero trim” on page 48.

---

### 3.5.2 Rosemount 306 In-line Manifold installation procedure

The Rosemount 306 is for use only with a Rosemount 4088 In-line Transmitter.

 Assemble the Rosemount 306 to the Rosemount 4088 with a thread sealant.

1. Place transmitter into holding fixture.
2. Apply appropriate thread paste or tape to threaded instrument end of the manifold.
3. Count total threads on the manifold before starting assembly.
4. Start turning the manifold by hand into the process connection on the transmitter.

---

**Note**

If using thread tape, be sure the thread tape does not strip when the manifold assembly is started.

---

5. Wrench tighten manifold into process connection.

---

**Note**

Minimum torque value is 425 in-lb.

---

6. Count how many threads are still showing.

---

**Note**

Minimum engagement is three revolutions.

---

7. Subtract the number of threads showing (after tightening) from the total threads to calculate the revolutions engaged. Further tighten until a minimum of three rotations is achieved.
8. For block and bleed manifold, verify the bleed screw is installed and tightened. For 2-valve manifold, verify the vent plug is installed and tightened.
9. Leak-check assembly to maximum pressure range of transmitter.

### 3.5.3 Rosemount 304 Conventional Manifold installation procedure

To install a Rosemount 304 to a Rosemount 4088:

1. Align the conventional manifold with the transmitter flange. Use the four manifold bolts for alignment.
2. Finger tighten the bolts, then tighten the bolts incrementally in a cross pattern (see [Figure 3-14](#)) to final torque value. See [Table 6-4 on page 122](#) for complete bolt installation information and for torque values. When fully tightened, the bolts should extend through the top of the module housing plane of the flange web (i.e. bolt hole) but must not contact the module housing.
3. If applicable, install flange adapters on the process end of the manifold using the 1.75-in. flange bolts supplied with the transmitter.

**Figure 3-14. Bolt Tightening Pattern**

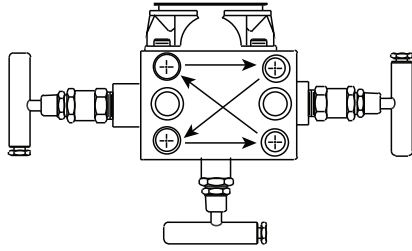

### 3.5.4 Rosemount 305 and 304 Manifold styles

The Rosemount 305 Integral Manifold is available in two styles: coplanar and traditional. The traditional Rosemount 305 can be mounted to most primary elements with mounting adapters.

**Figure 3-15. Rosemount 305 Manifold Styles**

**Integral coplanar    Integral traditional**

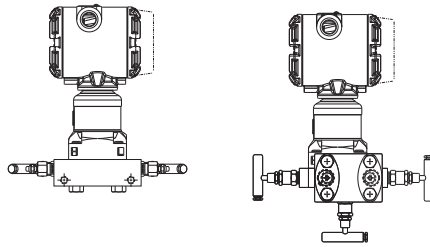

The Rosemount 304 comes in two basic styles: traditional (flange + flange and flange + pipe) and wafer. The Rosemount 304 traditional manifold comes in 2-, 3-, and 5-valve configurations. The Rosemount 304 wafer manifold comes in 3- and 5-valve configurations.

**Figure 3-16. Rosemount 304 Manifold Styles**

**Traditional    Wafer**

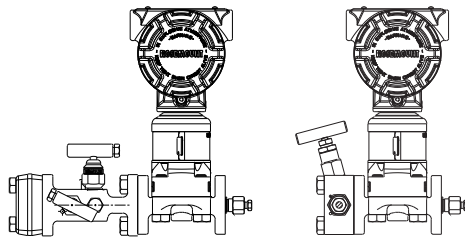

### 3.5.5 Manifold operation

**⚠ WARNING**

Improper installation or operation of manifolds may result in process leaks, which may cause death or serious injury.

Always perform a zero trim on the transmitter/manifold assembly after installation to eliminate any shift due to mounting effects. See [Section 5: Operation and Maintenance, “Sensor trim overview”](#) on page 105.

#### Coplanar transmitters

##### 3-valve and 5-valve manifolds

###### Performing zero trim at static line pressure

In normal operation the two isolate (block) valves between the process ports and transmitter will be open and the equalize valve will be closed.

1. To zero trim the transmitter, close the isolate valve on the low side (downstream) side of the transmitter.

2. Open the equalize valve to equalize the pressure on both sides of the transmitter. The manifold is now in the proper configuration for performing a zero trim on the transmitter.

3. After performing a zero trim on the transmitter, close the equalize valve.

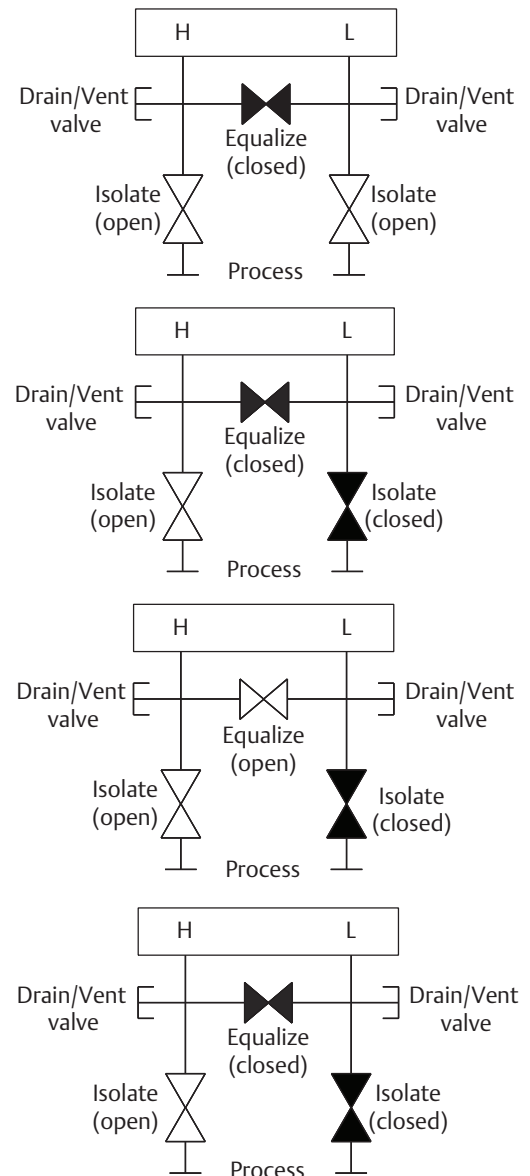



- Finally, to return the transmitter to service, open the low side isolate valve.

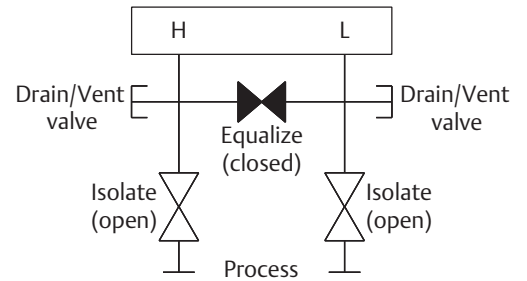

## 5-valve natural gas manifold

### Performing zero trim at static line pressure

5-valve natural gas configurations shown:

In normal operation, the two isolate (block) valves between the process ports and transmitter will be open, and the equalize valves will be closed. Vent valves may be opened or closed.

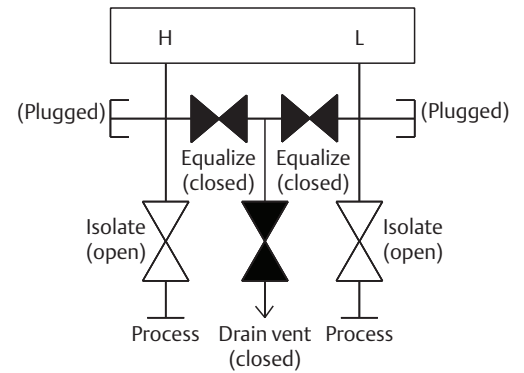

- To zero trim the transmitter, first close the isolate valve on the low pressure (downstream) side of the transmitter and the vent valve.

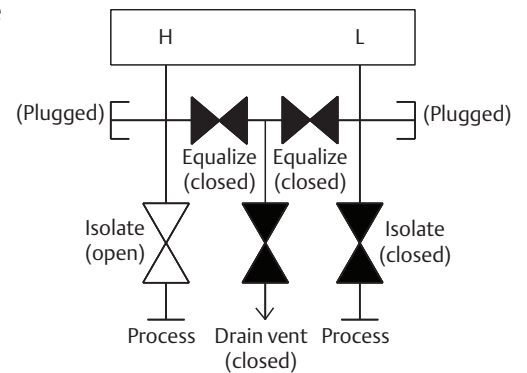

- Open the equalize valve on the high pressure (upstream) side of the transmitter.

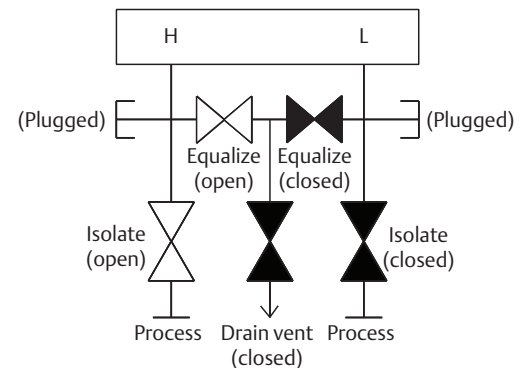

3. Open the equalize valve on the low pressure (downstream) side of the transmitter. The manifold is now in the proper configuration for performing a zero trim on the transmitter.

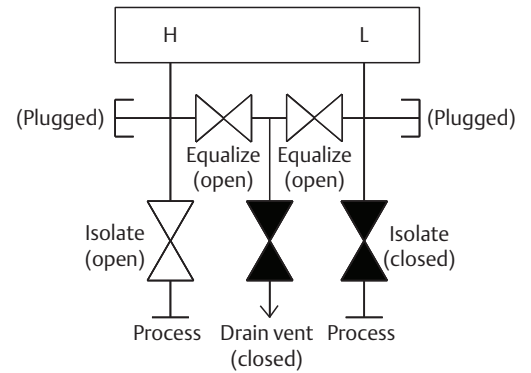

4. After performing a zero trim on the transmitter, close the equalize valve on the low pressure (downstream) side of the transmitter.

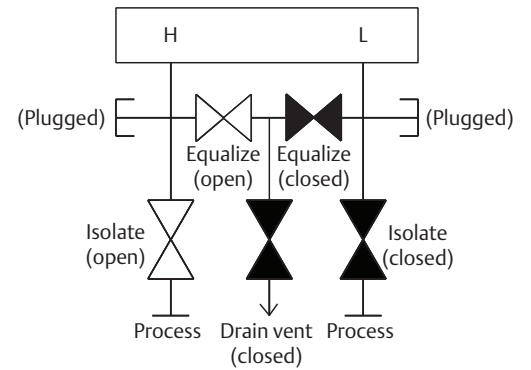

5. Close the equalize valve on the high pressure (upstream) side.

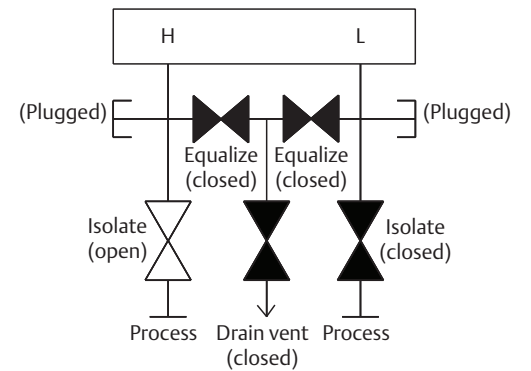

6. Finally, to return the transmitter to service, open the low side isolate valve and vent valve. The vent valve can remain open or closed during operation.

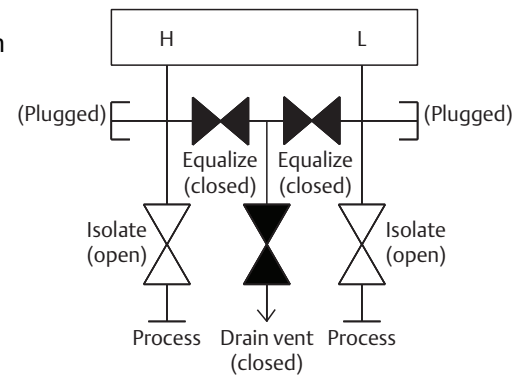

## In-line transmitters

### 2-valve and block and bleed style manifolds

#### Isolating the transmitter

In normal operation the isolate (block) valve between the process port and transmitter will be open and the test/vent valve will be closed. On a block and bleed style manifold, a single block valve provides transmitter isolation and a bleed screw provides drain/vent capabilities.

1. To isolate the transmitter, close the isolate valve.

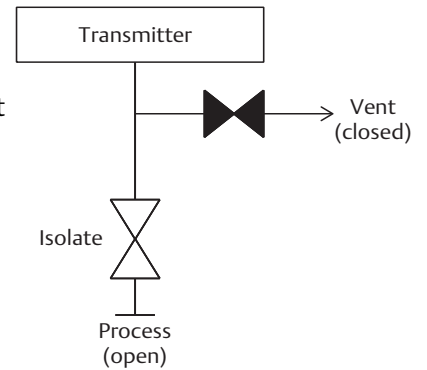

2. To bring the transmitter to atmospheric pressure, open the vent valve or bleed screw.

**Note**  
A 1/4-in. male NPT pipe plug may be installed in the test/vent port and will need to be removed with a wrench in order to vent the manifold properly. Always use caution when venting directly to atmosphere.

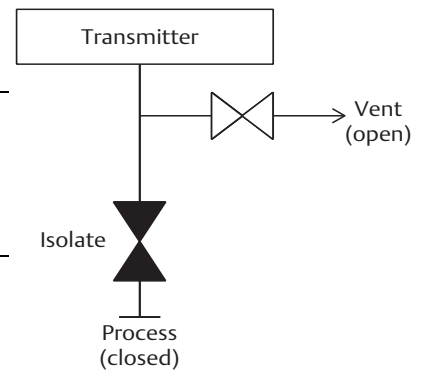
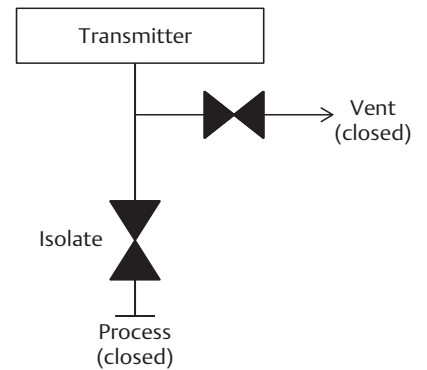

3. After venting to atmosphere, perform any required calibration and then close the test/vent valve or replace the bleed screw.

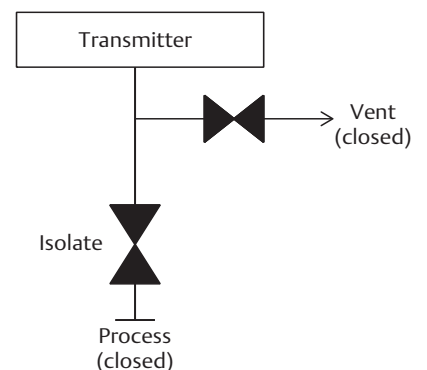

4. Open the Isolate (block) valve to return the transmitter to service.

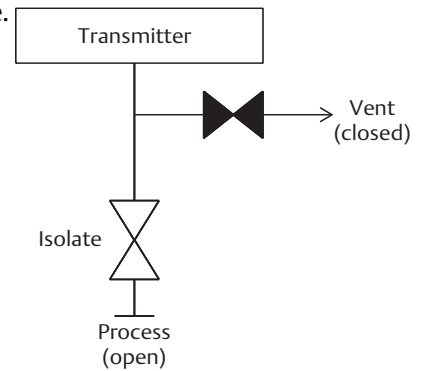

## Adjusting valve packing

Over time, the packing material inside a Rosemount manifold may require adjustment in order to continue to provide proper pressure retention. Not all manifolds have this adjustment capability. The manifold model number will indicate what type of stem seal or packing material has been used.

The following steps are provided as a procedure to adjust valve packing:

1. Remove all pressure from device.
2. Loosen manifold valve jam nut.
3. Tighten manifold valve packing adjuster nut  $1/4$  turn.
4. Tighten manifold valve jam nut.
5. Re-apply pressure and check for leaks.
6. Above steps can be repeated, if necessary.

If the above procedure does not result in proper pressure retention, the complete manifold should be replaced.

**Figure 3-17. Adjusting Valve Packing**

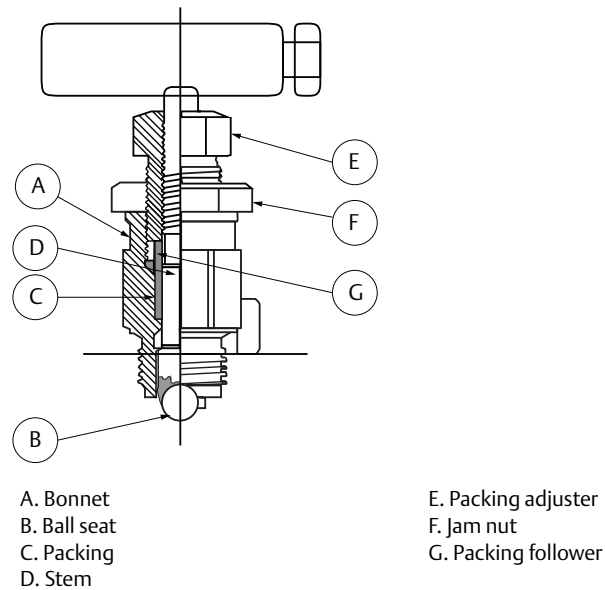

## Section 4 Communication

---

Rosemount 4088A Modbus communications .....	page 57
Rosemount 4088B ROC communications .....	page 77
Rosemount 4088B BSAP communications .....	page 78

---

### 4.1 Rosemount 4088A Modbus communications

This section contains the Modbus® interface and register map used in the Rosemount™ 4088A Transmitter. Use this section to locate the Modbus register for the process variables and status bits that will be retrieved from the Rosemount 4088A. The purpose of including this register map is to provide the information required to implement this register map within a host in order to achieve an effective exchange of data with the Rosemount 4088A. It is expected that anyone creating such an interface has a thorough understanding of the Modbus protocol. Reference the “Modicon Modbus Protocol Reference Guide PI-MBUS-300 Rev. J” published by Modicon, Inc., Industrial Automation Systems for further information.

---

#### Note

Coplanar transmitter configurations measuring gage pressure with optional process temperature (measurement type 5 and 7) will report the pressure as differential pressure. This will be reflected on the LCD display nameplate, digital interfaces, and other user interfaces.

---

#### 4.1.1 Modbus communication overview

The Rosemount 4088A is a Modbus-compatible measurement device. The Rosemount 4088A supports standard Modbus RTU transmission mode.

#### Physical layer requirements

- RS-485
- 2-wire
- Half-duplex

#### Data format (not configurable)

- Data bits: 8
- Stop bits: 1
- Parity: None
- Bit order: least significant byte (LSB)

#### Baud rate (software configurable)

- Default baud rate: 9600
- Available baud rates: 1200, 2400, 4800, 9600, 19200

Make sure the RS-485 network is only terminated twice on the entire bus. Best practice would suggest this be done once on each end. Termination at multiple points on the bus will hamper communication.

To help with this, the electronics board features an “AC Termination” switch that allows AC termination to be either enabled or disabled. See “Set the switches” on page 43 for more information.

The format for both query and response frames is as follows:



For communication to a specific Rosemount 4088A, the address field contains the slave’s polling address. In a broadcast frame, the address field contains a 0. Only Modbus function codes that write to a register or coil are valid in a broadcast message. Address 0 is reserved for broadcast messages and therefore is not a valid Modbus slave address.

All Rosemount 4088A Transmitters will respond to messages sent to Address 240. For this reason, Address 240 is considered a universal address. This address is useful when there is only a single device on a segment and its unique polling address is unknown. Using Address 240, the device can be queried to find the device address in Holding Register 0016. Since every device on a segment will respond to commands given to Address 240, it should never be used when there is more than a single device on a segment.

The function field contains a function code, which indicates the read, write or diagnostic command to be performed as part of a query. When the Rosemount 4088A responds to a query, the function field will either verify the device’s response or provide an exception that explains any errors encountered while processing the command. Table 4-1 provides an overview of these response codes. When a transmitter receives a query, it will not respond until the command has been completed. No subsequent commands will be processed until the first command is finished.

**Table 4-1. Exception Response Codes**

Exception response	Description	Explanation
01	Illegal function	The received message function is not an allowable action for the transmitter.
02	Illegal data address	The address referenced in the data field is not an allowable address for the memory location.
03	Illegal data value	The value referenced in the data field is not allowed in the addressed memory location.
04	Slave device failure	An unrecoverable error occurred while the slave was attempting to perform the requested action.
06	Slave device is busy	The slave is engaged in processing a long duration command. The host should retransmit the message later when the slave is free.

The data field contains information that is specific to each individual function.

The error check field contains a 16-bit CRC checksum that is used to verify the integrity of the message frame.

## 4.1.2 Modbus data types

The transmitter’s mapped addresses store and use data types supported by many Modbus-compatible PLC’s and host controllers. Table 4-2 on page 59 lists those data types according to their mapped addresses and corresponding function codes.

All registers in this document are referenced to one. The registers in Modbus messages are referenced to zero. This means the number of the mapped address register (i.e. 0005) is one higher than the actual number (i.e. 0004) that is sent in the Modbus frame message. Depending on whether the Modbus host is

referenced to a 1 or 0, it may be required to add or subtract a 1 from the register to be accessed (ex. 0400 instead of 0401) for successful data acquisition between the host and transmitter.

Floating point values are stored as single precision IEEE 754 floating point numbers. These floating point numbers are stored as either two 16-bit registers or as one 32-bit register.

**Table 4-2. Data Types According to Function Code and Mapped Address**

Register start	Register end	Register size (bits)	Function codes	Register type	Description
1	102	1	01, 02, 05	Coil	Single on/off bit per Boolean coil state
397 7399	652 7526	16 32	03, 04, 06 <sup>(1)</sup> 16, 69, 70	Floating point register	IEEE 754 floating point number (accessed in either two 16-bit or one 32-bit register).
1	362	16	03, 04 06, 16	Holding registers	One 16-bit unsigned integer per register (shares the same register range with the holding registers and ASCII registers).

1. Floating point numbers can only be written with function code 06 if the register is a 32-bit register.

### 4.1.3 Modbus function codes

The Rosemount 4088 supports the following function codes, which include read, write and diagnostic commands.

**Table 4-3. Modbus Function Codes**

Function code	Command type	Description	Explanation
01	Read	Read coil status	Read ON/OFF status of one coil or consecutive coils
02	Read	Read input status	Read ON/OFF status of one discrete input or consecutive discrete inputs
03	Read	Read holding registers	Read values of one or more holding registers
04	Read	Read input registers	Read values of one or more input registers
05	Write	Force single coil	Set coil to a specified ON or OFF state
06	Write	Preset single register	Write a value to holding register
08	Diagnostic	Loopback diagnostics	Send a diagnostic test message to the transmitter to evaluate communications processing
16	Write	Preset multiple registers	Write values to consecutive holding registers
69	Read	Read multiple floating point registers	Read values of one or more 32-bit floating point registers
70	Write	Load multiple floating point registers	Write values to consecutive 32-bit floating point registers

Once the transmitter has been configured, the configuration data can be protected by moving the Transmitter Security switch to the ON position. This switch is located on the left side of the Electronics Board and is labeled “Security”. If the Transmitter Security switch is ON and the host tries to write to a register location, the Modbus exception Illegal Data Address (02) will be returned. Any exceptions to this are noted in the Modbus register maps. See “[Set the switches](#)” on page 43 for more information.

### 4.1.4 Registers for process variables

A complete register map, including coils, holding, floating point and diagnostics are found later in this section. The register map for the process variables has been designed such that all dynamic process

information can be obtained with a single read. The registers that provide this capability are shown in [Table 4-4](#). In the event of a sensor malfunction, the transmitter will return “NAN” (not a number) for the numeric value.

**Table 4-4. Modbus Registers for Process Variables**

Register number (16-bit)	Register number (32-bit)	Description
0397-0398 Byte 0	7399 Byte 0	Sensor module temperature variable status
0397-0398 Byte 1	7399 Byte 1	Differential pressure variable status
0397-0398 Byte 2	7399 Byte 2	Static pressure variable status
0397-0398 Byte 3	7399 Byte 3	Process temperature variable status
0399-0400	7400	Sensor module temperature
0401-0402	7401	Differential pressure
0403-0404	7402	Static pressure
0405-0406	7403	Process temperature
0407-0410	7404-7405	Transmitter status information

## 4.1.5 Process variable integer scaling

The process variables can also be read as 16-bit scaled integers, as shown in [Table 4-5](#). Integer scaling can result in significant loss of precision for the process variables and should only be done if the application can support this degradation. If scaled integers are disabled, all scaled integers will be set to 65535.

**Table 4-5. Register Locations for Process Variables Presented as Scaled Integers**

Process variable	16-bit register
Differential pressure	0116
Static pressure	0117
Process temperature	0118

There are two separate ways to configure the Scaled Integers. In the “Entered Endpoint” method, the (x1, y1) and (x2, y2) endpoints for the scaling line are defined as shown in [Figure 4-1](#). The unit codes for the x-values for the endpoints should be the same as the current process variable unit code. If the process variable unit codes after the scaled integers are set, the x-values will be automatically updated to reflect the new unit code.



Figure 4-1. Integer Scaling

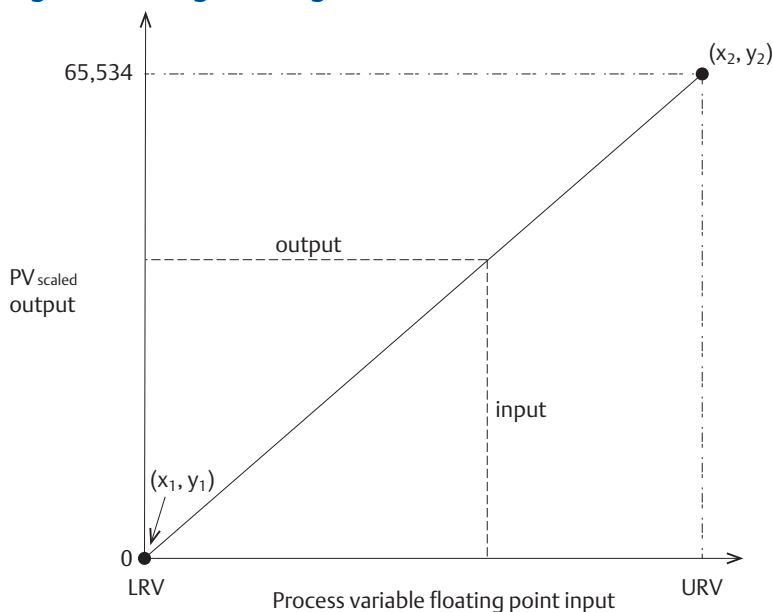

In the “Entered Scale Factor and Offset” method, a scale factor and an offset describing the relationship between the measured variable and the  $PV_{scaled}$  output are specified. The scale factor is the change of the scaled integers compared to the change of the measured process variable. The offset should be determined through use of the equation shown below:

$$PV_{scaled} = (\text{scale factor} \times \text{input}) + (32,768 - \text{offset})$$

The scale factor and offset must be configured for the correct unit codes. If the unit codes are changed, the scale factor and offset must be recalculated.

- ⚠ If the measured value derives an integer higher than the maximum integer or lower than zero, the maximum integer plus one will be returned. Also, if any of the defined error conditions occur, the affected scaled integers will be set to the maximum integer plus one. The maximum integer value can be any value from 1 to 65,534. The default maximum integer value is 65,534.

## 4.1.6 Floating point formats

The Rosemount 4088A has the capability to rearrange the transmission byte order of the floating point registers. The floating point registers will still be in IEEE 754 format, only the transmission byte order will change. The configuration of the byte transmission order is held in holding register 0132. Changing the configuration of the Rosemount4088A with regard to the byte transmission order affects both the reading and writing of floating point registers. It will not affect the byte transmission order of the integer data.

The floating point format byte order is shown in [Table 4-6 on page 62](#).

**Table 4-6. Floating Point Format**

Byte order				
	Byte A	Byte B	Byte C	Byte D
IEEE 754 Floating Point	SEEE EEEE	EMMM MMMM	MMMM MMMM	MMMM MMMM
Format 0	1	2	3	4
Format 1	3	4	1	2
Format 2	4	3	2	1
Format 3	2	1	4	3

**Note**

“S” is the sign of the floating point number, “E” is the exponent, and “M” is the mantissa.

## 4.1.7 Communications

The Rosemount 4088A Transmitter can be configured with a turnaround delay time (holding register 0131), which defines how long the transmitter will wait to respond after receiving a query from the host. If the Turnaround Delay Time is set to zero, the device will respond as fast as it can. The default Turnaround Delay Time is 50 milliseconds.

The registers shown in [Table 4-7](#) provide statistics that may be used to gather diagnostic information about the communications between the device and the host. The communications statistics will reset when the Rosemount 4088A loses power or if a Master Reset is performed. The registers will be reset to zero when the value in the registers exceeds the maximum value for an unsigned 16-bit number.

**Table 4-7. Communication Statistics**

Address	Register type	Attribute	Description
0145	Holding	Read Only	Network Port Framing Error
0147	Holding	Read Only	Network Port Overrun Error
0148	Holding	Read Only	Network Port CRC Error
0150	Holding	Read Only	Network Port Good Message Count

## 4.1.8 Implementing calibration

Each process variable in the Rosemount 4088A (differential pressure [DP], static pressure [SP] and process temperature [PT]) can be calibrated through a trim process, either a zero trim or a two-point trim. The lower trim value acts the same as a zero trim. The upper trim serves to adjust the span (or slope) of the device. The trim values should be written to the appropriate Floating Point Registers in [Table 4-12](#). A Modbus coil (0003) has been provided as a way of flagging the transmitter is in a calibration state. The host has complete control of the calibration flag. The coil is intended for informational use and does not affect the internal operation of the device. The status of this coil can be read by coil 0050 which is a part of transmitter status.

For accurate calibration, the user should be prompted to wait for the process variable to stabilize before attempting to trim the transmitter. The host should never write the lower (zero) and upper (span) trims at the same time; the device will reject this type of request. For best results, a Lower Trim should be completed before attempting the Upper Trim.

## 4.1.9 Diagnostics

The Rosemount 4088A features a number of diagnostic status bits that give information about the status of the transmitter. A complete listing of these diagnostic status bits are shown in [Table 4-8](#). The status bits can be read as coils, holding registers, or floating point registers. In a polling environment, the host should retrieve the Process Variables and Status Registers in a single query. The Rosemount 4088A will automatically perform a continuous self-test, such that there is no requirement for a host to perform any independent procedures. For information on alarms and conditions, see [“Alarms and conditions” on page 115](#).

Activating the master reset coil performs a reset of the Rosemount 4088A. This is similar to shutting off the power and then reapplying power. The master reset takes approximately five seconds to complete. For more information, see [Table 4-10 on page 66](#).

**Table 4-8. Transmitter Status and Diagnostic Registers**

32-bit floating register address	16-bit floating register address	Holding register address	Bit position	Coil	Description
7404	0407	0119	15	50	Calibration flag
			14	51	Critical alarm set
			13	52	Warning alarm set
			12	53	Differential pressure out of limit (High)
			11	54	Reserved
			10	55	Differential pressure above upper alert limit
			9	56	Differential pressure below lower alert limit
			8	57	Reserved
			7	58	Differential pressure out of limit (Low)
			6	59	Static pressure out of limit (High)
			5	60	Reserved
			4	61	Static pressure above upper alert limit
			3	62	Static pressure below lower alert limit
			2	63	Reserved
			1	64	Static pressure out of limit (Low)
			0	65	Reserved

**Table 4-8. Transmitter Status and Diagnostic Registers**

32-bit floating register address	16-bit floating register address	Holding register address	Bit position	Coil	Description
7404	0408	0120	15	66	Reserved
			14	67	Reserved
			13	68	Process temperature out of limit (High)
			12	69	Process temperature above upper alert limit
			11	70	Process temperature below lower alert limit
			10	71	Process temperature out of limit (Low)
			9	72	Reserved
			8	73	Process temperature sensor failure
			7	74	Sensor module temperature out of limit (High)
			6	75	Sensor module temperature out of limit (Low)
			5	76	Sensor module temperature above upper alert limit
			4	77	Sensor module temperature below lower alert limit
			3	78	RTD sensor type mismatch
			2	79	LCD communication update failure
			1	80	Sensor module failure
			0	81	Reserved
7405	0409	0121	15	82	Sensor module communication error
			14	83	Power failure
			13	84	Reserved
			12	85	Reserved
			11	86	Sensor module incompatibility
			10	87	Reserved
			9	88	Reserved
			8	89	Differential pressure simulation enabled
			7	90	Static pressure simulation enabled
			6	91	Reserved
			5	92	Electronic circuit board error
			4	93	Reserved
			3	94	Process temperature simulation enabled
			2	95	Reserved
1	96	Transmitter security switch enabled			
0	97	Sensor module temperature simulation enabled			
7405	0410	0122	15-0	N/A	Reserved

In addition, each dynamic variable has one byte of status accessible via a holding or floating point register. These dynamic variables include differential pressure, static pressure, process temperature and sensor module temperature. Each variable status reading consists of two parts: measurement quality and limit status. These variable statuses are found in the register map for holding and floating point registers.

### Possible responses for measurement quality status

Good – Displays during normal device operation.

Poor Accuracy – Indicates the accuracy of the variable measurement has been compromised.

Example: The sensor module temperature sensor failed and is no longer compensating the differential pressure measurement.

Manual/Fixed – Indicates the variable reading has been set to a fixed, user-specified value and may not represent the actual process. This status is set if a variable reading is being simulated or if the Process Temperature is set to use a fixed value.

Bad – Indicates the variable has failed. Example: The differential pressure sensor has failed.

### Possible responses for measurement limit status

Not Limited – Displays during normal device operation.

High Limited – Indicates the current variable reading has gone above the transmitter’s maximum possible reading and is no longer representative of the actual measurement.

Low Limited – Indicates that current variable reading has gone below the transmitter’s minimum possible reading and is no longer representative of the actual measurement.

Constant – Indicates the variable reading is set to a fixed value. Example: The variable has been left in fixed simulation mode.

## 4.1.10 Transmitter register maps

This section contains three register maps for the Rosemount 4088A. These maps include one for “Coils”, one for “Holding Parameters” and one for “Floating Point Parameters” (see “[Modbus data types](#)” on [page 58](#) for additional information). The maps are formatted according to [Table 4-9](#). For a spreadsheet of this register map, contact your local Emerson™ representative or visit [Emerson.com/Rosemount](http://Emerson.com/Rosemount).

**Table 4-9. Format for Modbus Register Maps**

Column name	Description
Register number	Indicates register number to be used to read specific parameter. Floating point registers can be read in 16-bit format and 32-bit format. Different sets of register numbers are defined for both formats.
Register name	Name of parameter; each parameter will have unique meaningful name to understand usage of the parameter.
Access type	Indicates access options when parameter is used from Modbus; valid options are: 1. RO - Parameter is read only. 2. RW - Parameter can be written when the transmitter Security switch is in the OFF position. Some parameters can be written regardless of the Security switch position. These parameters are noted in the register map.
Description	Gives the valid options for the parameter or the parameter’s engineering unit.

Table 4-10. Coil Registers

Register number	Register name	Access type	Description
0002	Master reset	RW	OFF = No action ON = Perform reset Coil can be written regardless of the transmitter Security switch state
0003	Calibration in progress	RW	The host is responsible for setting this flag; the device does not change the value. OFF = Calibration not in progress ON = Calibration in progress
0004	Process temperature present	RW	OFF = Disabled (Fixed RTD mode) ON = Enabled (Normal/Backup mode)
0031	Restore differential pressure factory calibration	RW	OFF = No action ON = Reset differential pressure trims to factory default
0032	Restore static pressure factory calibration	RW	OFF = No action ON = Reset static pressure trims to factory default
0033	Restore process temperature factory calibration	RW	OFF = No action ON = Reset process temperature trims to factory default
0034	Reset Callendar-van Dusen to IEC 751 defaults	RW	OFF = No action ON = Reset Callendar-Van Dusen to IEC 751 defaults
0050–0097	Transmitter status	RO	See <a href="#">Table 4-8 on page 63</a> OFF = Status bit cleared ON = Status bit set
0098	Enable differential pressure simulation	RW	OFF = Simulation disabled ON = Simulation enabled
0099	Enable static pressure simulation	RW	OFF = Simulation disabled ON = Simulation enabled
0100	Enable process temperature simulation	RW	OFF = Simulation disabled ON = Simulation enabled
0101	Enable sensor module temperature simulation	RW	OFF = Simulation disabled ON = Simulation enabled
0102	Transmitter security switch status	RO	OFF = Disabled ON = Enabled

Table 4-11. Holding Registers

Register number	Register name	Access type	Description
0001	Transmitter manufacturer	RO	38 = Rosemount
0002	Legacy type code	RO	N/A
0003	Software revision	RO	N/A
0005–0006	Sensor module serial number	RO	N/A
0007–0008	Electronics board serial number	RO	N/A
0009	Hardware revision	RO	N/A
0010	Modbus revision	RO	N/A

Table 4-11. Holding Registers

Register number	Register name	Access type	Description
0011	Static pressure sensor type	RO	0 = Gage pressure sensor 1 = Absolute pressure sensor
0012	Sensor module configuration	RO	0 = Standard coplanar (C) 1 = Standard threaded (T) 2 = Level coplanar (L) 3 = Reference class coplanar (P) 4 = High temperature conventional (H) 252 = Unknown
0013	Sensor module type	RO	0 = Differential pressure (DP) 1 = Gage pressure (GP) 2 = Absolute pressure (AP) 6 = DP with AP high side static pressure 7 = DP with GP high side static pressure 253 = Custom
0014	Device configuration	RO	Bit 0 = DP sensor installed Bit 1 = AP pressure installed Bit 2 = GP pressure installed Bit 3 = PT sensor installed Bit 4 = LCD display installed Bit 5 = 4088 mode B Bit 6 = N/A Bit 7 = N/A
0015	Device model	RO	0x2668 1st byte is manufacture id (RMT = 26 Hex) 2nd byte is device type (68 Hex)
0016	Device address	RW	Valid addresses are 1-239
0017	Differential pressure sensor range	RO	0 = 0 1 = 1 2 = 2 3 = 3 4 = 4 5 = 5 10 = A (extended range) 253 = Special
0018	Static pressure sensor range	RO	0 = 0 1 = 1 2 = 2 3 = 3 4 = 4 5 = 5 6 = 6 7 = 7 253 = Special
0019	Temperature sensor range code	RO	3 = -200 to 850 °C
0020	Isolating diaphragm material	RO	2 = 316L Stainless Steel 3 = Alloy C-276 4 = Alloy 400 5 = Tantalum 15 = Gold-plated Alloy 400 34 = Gold-plated 316L SST 35 = Gold-plated Alloy C-276 253 = Special

**Table 4-11. Holding Registers**

Register number	Register name	Access type	Description
0021	Sensor module fill fluid	RO	1 = Silicone 2 = Inert 7 = Neobee® M-20 252 = Unknown 253 = Special
0022	Process connection material	RW	0 = Carbon Steel 2 = 316 Stainless Steel 3 = Cast C-276 4 = Alloy 400 30 = Alloy C-276 252 = Unknown 253 = Special
0023	Process connection style	RW	12 = Conventional (traditional) 13 = Coplanar 14 = Remote seal 15 = Level; 3-in., 150 lb 16 = Level; 4-in., 150 lb 17 = Level; 3-in., 300lb 18 = Level; 4-in., 300 lb 19 = Level; DN 80, PN 40 20 = Level; DN 100, PN 40 21 = Level; DN 100, PN 10/16 22 = Level; 2-in., 150 lb 23 = Level; 2-in., 300 lb 24 = Level; DN 50, PN 6 25 = Level; DN 50, PN 40 44 = 1/2-in., NPTF 45 = DIN16288G 1/2 A male 46 = 1/4-in., NPTF 240 = Auto clave F-250-C 241 = Tri Clamp 242 = Fractional line fit 243 = 1/8-in., NPTF 244 = VCR 245 = PMC 246 = Traditional RC 1/4 247 = Traditional RC 1/2 252 = Unknown 253 = Special
0024	Drain/vent valve material	RW	0 = Carbon Steel 2 = 316 Stainless Steel 3 = Cast C-276 4 = Alloy 400 30 = Alloy C-276 251 = None 252 = Unknown 253 = Special
0025	O-Ring material	RW	10 = PTFE 11 = Viton® 12 = Buna-N 13 = Ethyl propionate 36 = PTFE glass 37 = PTFE graphite 251 = None 252 = Unknown 253 = Special



Table 4-11. Holding Registers

Register number	Register name	Access type	Description
0026	Remote seal type	RW	2 = CTW 3 = EFW 4 = PFW 5 = RFW 6 = RTW 7 = SCW 8 = SSW 9 = High temperature 10 = FFW 11 = UCW 12 = TSW 13 = NWSP 14 = SSAP 15 = SSHP 16 = TFS 251 = None 252 = Unknown 253 = Special
0027	Remote seal fill fluid	RW	2 = Silicone oil 3 = SYLTHERM™ 800 4 = Inert 5 = Glycerin H <sub>2</sub> O 6 = Propylene glycol/H <sub>2</sub> O 7 = Neobee M-20 8 = SYLTHERM XLT 9 = Dioctyl phthalate 10 = Dow Corning® D.C. Silicone® 704 11 = Therminol 66 12 = D.C. Silicone 210H 13 = Distilled water 14 = D.C. Silicone 200 15 = D.C. Silicone 705 251 = None 252 = Unknown 253 = Special
0028	Remote seal isolating diaphragm material	RW	2 = 316 Stainless Steel 3 = Alloy C-276 4 = Alloy 400 5 = Tantalum 9 = Co-Cr-Ni 34 = PTFE-coated 316L SST 240 = Nickel 201 251 = None 252 = Unknown 253 = Special
0029	Number of remote seals	RW	1 = One seal 2 = Two seals 250 = Not used 251 = None 252 = Unknown 253 = Special
0030–0031	Date	RW	DDMMYY
0032–0035	Tag	RW	This field can hold numbers, symbols, upper-case letters (8 characters)

**Table 4-11. Holding Registers**

Register number	Register name	Access type	Description
0036–0043	Description	RW	This field can hold numbers, symbols, upper-case letters (16 characters)
0044–0059	Message	RW	This field can hold numbers, symbols, upper-case letters (32 characters)
0060	Differential pressure units	RW	1 = inH <sub>2</sub> O @ 60 °F 2 = Pa 3 = kPa 4 = MPa 5 = psi 6 = inH <sub>2</sub> O @ 68 °F 7 = bar 8 = mbar 9 = g/cm <sup>2</sup> 10 = kg/cm <sup>2</sup> 11 = inHg 12 = ftH <sub>2</sub> O 13 = torr 14 = atm 15 = mmH <sub>2</sub> O 16 = mmHg 238 = inH <sub>2</sub> O @ 4 °C 239 = mmH <sub>2</sub> O @ 4 °C
0061	Static pressure units	RW	
0062	Process temperature units	RW	20 = °C 21 = °F
0063	Sensor module temperature units	RW	20 = °C 21 = °F
0064	Sensor module temperature variable status	RO	Status format: Measurement quality - Limit status 0x00 = Bad - Not limited 0x10 = Bad - Low limited 0x20 = Bad - High limited 0x30 = Bad - Constant 0x40 = Poor accuracy - Not limited 0x50 = Poor accuracy - Low limited 0x60 = Poor accuracy - High limited 0x70 = Poor accuracy - Constant 0x80 = Manual/Fixed - Not limited 0x90 = Manual/Fixed - Low limited 0xA0 = Manual/Fixed - High limited 0xB0 = Manual/Fixed - Constant 0xC0 = Good - Not limited 0xD0 = Good - Low limited 0xE0 = Good - High limited 0xF0 = Good - Constant
0065	Differential pressure variable Status	RO	
0066	Static pressure variable status	RO	
0067	Process temperature variable status	RO	
0084	Configuration change counter	RO	N/A
0116	Differential pressure scaled integer	RO	N/A
0117	Static pressure scaled integer	RO	N/A
0118	Process temperature scaled integer	RO	N/A
0119–0121	Transmitter status	RO	See <a href="#">Table 4-8</a> .
0125	Maximum scale value	RW	N/A
0126	LCD display scroll time	RW	Value given in seconds

Table 4-11. Holding Registers

Register number	Register name	Access type	Description
0127–0128	Display options	RW	Bit 0 = Differential pressure Bit 1 = Absolute pressure Bit 2 = Process temperature Bit 3 = Baud rate Bit 4 = Gage pressure Bit 5 = Sensor module temperature Bit 7 = Device address Bit 8 = Parameter 1 Bit 9 = Parameter 2 Bit 10 = Parameter 3 Bit 11 = Parameter 4 Bit 12 = Parameter 5 Bit 13 = Parameter 6 Bit 16 = Variable 1 Bit 17 = Variable 2 Bit 18 = Variable 3
0131	Turnaround delay time (ms)	RW	N/A
0132	Floating byte transmission order	RW	0 = FORMAT 0 1 = FORMAT 1 2 = FORMAT 2 3 = FORMAT 3
0133	Baud rate	RW	1 = 1200 2 = 2400 3 = 4800 4 = 9600 5 = 19200
0134	Temperature mode	RW	0 = Fixed 1 = Normal 2 = Backup
0135	Temperature sensor type	RW	0 = 4-wire RTD sensor 1 = 3-wire RTD sensor
0145	Modbus port framing error count	RO	N/A
0147	Modbus port overrun error count	RO	N/A
0148	Modbus port CRC error count	RO	N/A
0150	Modbus port good message count	RO	N/A
0188	Differential pressure minimum scaled integer value	RW	N/A
0189	Differential pressure minimum scaled integer value	RW	N/A
0190	Static pressure minimum scaled integer value	RW	N/A
0191	Static pressure maximum scaled integer value	RW	N/A
0192	Process temperature minimum scaled integer value	RW	N/A
0193	Process temperature maximum scaled integer value	RW	N/A
0198	Differential pressure scale factor	RW	N/A

Table 4-11. Holding Registers

Register number	Register name	Access type	Description
0199	Differential pressure scale offset	RW	N/A
0200	Static pressure scale factor	RW	N/A
0201	Static pressure scale offset	RW	N/A
0202	Process temperature scale factor	RW	N/A
0203	Process temperature scale offset	RW	N/A
0204	Integer scaling method	RW	0 = Disabled 1 = Entered endpoints 2 = Entered scale factor and offset
0207–0211	User-Defined Parameter 1 label	RW	ISO-Latin-1 (10 characters)
0212–0214	User-Defined parameter 1 units	RW	ISO-Latin-1 (5 characters, the last byte is truncated)
0215–0219	User-Defined parameter 2 label	RW	ISO-Latin-1 (10 characters)
0220–0222	User-Defined parameter 2 units	RW	ISO-Latin-1 (5 characters, the last byte is truncated)
0223–0227	User-Defined parameter 3 label	RW	ISO-Latin-1 (10 characters)
0228–0230	User-Defined parameter 3 units	RW	ISO-Latin-1 (5 characters, the last byte is truncated)
0231–0235	User-Defined parameter 4 label	RW	ISO-Latin-1 (10 characters)
0236	Reserved	N/A	N/A
0237–0239	User-Defined parameter 4 units	RW	ISO-Latin-1 (5 characters, the last byte is truncated)
0240	Reserved	N/A	N/A
0241–0245	User-Defined parameter 5 label	RW	ISO-Latin-1 (10 characters)
0246–0248	User-Defined parameter 5 units	RW	ISO-Latin-1 (5 characters, the last byte is truncated)
0249–0253	User-Defined parameter 6 label	RW	ISO-Latin-1 (10 characters)
0254–0256	User-Defined parameter 6 units	RW	ISO-Latin-1 (5 characters, the last byte is truncated)
0257–0261	User-Defined variable 1 label	RW	ISO-Latin-1 (10 characters)
0262–0264	User-Defined variable 1 units	RW	ISO-Latin-1 (5 characters, the last byte is truncated)
0265–0269	User-Defined variable 2 label	RW	ISO-Latin-1 (10 characters)
0270–0272	User-Defined variable 2 units	RW	ISO-Latin-1 (5 characters, the last byte is truncated)
0273–0277	User-Defined variable 3 label	RW	ISO-Latin-1 (10 characters)
0278–0280	User-Defined variable 3 units	RW	ISO-Latin-1 (5 characters, the last byte is truncated)
0281–0296	Long tag	RW	ISO-Latin-1 (32 characters)
0297–0312	Model number 1	RW	This field can hold numbers, symbols, and upper-case letters (32 characters)
0313–0328	Model number 2	RW	This field can hold numbers, symbols, and upper-case letters (32 characters)
0329–0344	Model number 3	RW	This field can hold numbers, symbols, and upper-case letters (32 characters)

**Table 4-11. Holding Registers**

Register number	Register name	Access type	Description
0345–0360	Model number 4	RW	This field can hold numbers, symbols, and upper-case letters (32 characters)
0361–0362	Transmitter serial number	RW	N/A

**Table 4-12. Floating Point Registers**

Register number (16-bit)	Register number (32-bit)	Register name	Access type	Units
0397–0398 Byte 0	7399 Byte 0	Sensor module temperature variable status	RO	Each byte is independent and can take on values of: Status format: Measurement quality - Limit status 0x00 = Bad - Not limited 0x10 = Bad - Low limited 0x20 = Bad - High limited 0x30 = Bad - Constant 0x40 = Poor accuracy - Not limited 0x50 = Poor accuracy - Low limited 0x60 = Poor accuracy - High limited 0x70 = Poor accuracy - Constant 0x80 = Manual/Fixed - Not limited 0x90 = Manual/Fixed - Low limited 0xA0 = Manual/Fixed - High limited 0xB0 = Manual/Fixed - Constant 0xC0 = Good - Not limited 0xD0 = Good - Low limited 0xE0 = Good - High limited 0xF0 = Good - Constant
0397–0398 Byte 1	7399 Byte 1	Differential pressure variable status	RO	
0397–0398 Byte 2	7399 Byte 2	Static pressure variable status	RO	
0397–0398 Byte 3	7399 Byte 3	Process temperature variable status	RO	
0399–0400	7400	Sensor module temperature	RO	Sensor module temperature units
0401–0402	7401	Differential pressure	RO	Differential pressure units
0403–0404	7402	Static pressure	RO	Static pressure units
0405–0406	7403	Process temperature	RO	Process temperature units
0407–0410	7404–7405	Transmitter status	RO	<a href="#">Table 4-8 on page 63</a>
0413–0414	7407	Differential pressure upper sensor limit	RO	Differential pressure units
0415–0416	7408	Differential pressure lower sensor limit	RO	Differential pressure units
0417–0418	7409	Differential pressure upper alert limit	RW	Differential pressure units
0419–0420	7410	Differential pressure lower alert limit	RW	Differential pressure units
0421–0422	7411	Static pressure upper sensor limit (for installed sensor)	RO	Static pressure units
0423–0424	7412	Static pressure lower sensor limit (for installed sensor)	RO	Static pressure units
0425–0426	7413	Static pressure upper alert limit	RW	Static pressure units
0427–0428	7414	Static pressure lower alert limit	RW	Static pressure units
0429–0430	7415	Process temperature upper sensor limit	RW	Process temperature units

Table 4-12. Floating Point Registers

Register number (16-bit)	Register number (32-bit)	Register name	Access type	Units
0431-0432	7416	Process temperature lower sensor limit	RW	Process temperature units
0433-0434	7417	Process temperature upper alert limit	RW	Process temperature units
0435-0436	7418	Process temperature lower alert limit	RW	Process temperature units
0437-0438	7419	Differential pressure lower trim	RW	Differential pressure units
0439-0440	7420	Differential pressure upper trim	RW	Differential pressure units
0441-0442	7421	Differential pressure damping	RW	Seconds
0443-0444	7422	Static pressure lower trim	RW	Static pressure units
0445-0446	7423	Static pressure upper trim	RW	Static pressure units
0447-0448	7424	Static pressure damping	RW	Seconds
0449-0450	7425	Process temperature lower trim	RW	Process temperature units
0451-0452	7426	Process temperature upper trim	RW	Process temperature units
0453-0454	7427	Process temperature damping	RW	Seconds
0455-0456	7428	Backup/fixed process temperature	RW	Process temperature units
0457-0458	7429	Sensor module temperature	RO	Sensor module temperature units
0469-0470	7435	Integer scaling: differential pressure minimum process variable	RW	Differential pressure units
0471-0472	7436	Integer scaling: Differential pressure maximum process variable	RW	Differential pressure units
0473-0474	7437	Integer scaling: Static pressure minimum process variable	RW	Static pressure units
0475-0476	7438	Integer scaling: Static pressure maximum process variable	RW	Static pressure units
0477-0478	7439	Integer scaling: Process temperature minimum process variable	RW	Process temperature units
0479-0480	7440	Integer scaling: Process temperature maximum process variable	RW	Process temperature units
0481-0482	7441	Process temperature Callendar-Van Dusen "A"	RW	N/A
0483-0484	7442	Process temperature Callendar-Van Dusen "B"	RW	N/A
0485-0486	7443	Process temperature Callendar-Van Dusen "C"	RW	N/A
0487-0488	7444	Process temperature Callendar-Van Dusen "R0"	RW	Ohms
0489-0490	7445	Sensor module temperature upper sensor limit	RO	Sensor module temperature units
0491-0492	7446	Sensor module temperature lower sensor limit	RO	Sensor module temperature units

**Table 4-12. Floating Point Registers**

Register number (16-bit)	Register number (32-bit)	Register name	Access type	Units
0493-0494	7447	Sensor module temperature lower alert limit	RW	Sensor module temperature units
0495-0496	7448	Sensor module temperature upper alert limit	RW	Sensor module temperature units
0497-0498	7449	Static pressure lower sensor limit (offset by atmospheric pressure)	RO	Static pressure units
0499-0500	7450	Static Pressure upper sensor limit (offset by atmospheric pressure)	RO	Static pressure units
0501-0502	7451	Absolute pressure	RO	Static pressure units
0503-0504	7452	Gage pressure	RO	Static pressure units
0505-0506	7453	User-defined atmospheric pressure	RW	Static pressure units
0507-0508	7454	Differential pressure low dp cutoff	RW	Differential pressure units
0509-0510	7455	User-defined parameter 1 value	RW	User-defined
0511-0512	7456	User-defined parameter 2 value	RW	User-defined
0513-0514	7457	User-defined parameter 3 value	RW	User-defined
0515-0516	7458	User-defined parameter 4 value	RW	User-defined
0517-0518	7459	User-defined parameter 5 value	RW	User-defined
0519-0520	7460	User-defined parameter 6 value	RW	User-defined
0521-0522	7461	User-defined variable 1 value	RW	Register can be written to regardless of the state of the transmitter Security switch.
0523-0524	7462	User-defined variable 2 value	RW	Register can be written to regardless of the state of the transmitter Security switch.
0525-0526	7463	User-defined variable 3 value	RW	Register can be written to regardless of the state of the transmitter Security switch.
0527-0528	7464	Differential pressure device reading 1	RO	Differential pressure units
0529-0530	7465	Differential pressure verification reference point 1	RW	Differential pressure units
0531-0532	7466	Differential pressure device reading 2	RO	Differential pressure units
0533-0534	7467	Differential pressure verification reference point 2	RW	Differential pressure units
0535-0536	7468	Differential pressure device reading 3	RO	Differential pressure units
0537-0538	7469	Differential pressure verification reference point 3	RW	Differential pressure units
0539-0540	7470	Differential pressure device reading 4	RO	Differential pressure units
0541-0542	7471	Differential pressure verification reference point 4	RW	Differential pressure units
0543-0544	7472	Differential pressure device reading 5	RO	Differential pressure units

Table 4-12. Floating Point Registers

Register number (16-bit)	Register number (32-bit)	Register name	Access type	Units
0545-0546	7473	Differential pressure verification reference point 5	RW	Differential pressure units
0547-0548	7474	Differential pressure device reading 6	RO	Differential pressure units
0549-0550	7475	Differential pressure verification reference point 6	RW	Differential pressure units
0551-0552	7476	Static pressure device reading 1	RO	Static pressure units
0553-0554	7477	Static pressure verification reference point 1	RW	Static pressure units
0555-0556	7478	Static pressure device reading 2	RO	Static pressure units
0557-0558	7479	Static pressure verification reference point 2	RW	Static pressure units
0559-0560	7480	Static pressure device reading 3	RO	Static pressure units
0561-0562	7481	Static pressure verification reference point 3	RW	Static pressure units
0563-0564	7482	Static pressure device reading 4	RO	Static pressure units
0565-0566	7483	Static pressure verification reference point 4	RW	Static pressure units
0567-0568	7484	Static pressure device reading 5	RO	Static pressure units
0569-0570	7485	Static pressure verification reference point 5	RW	Static pressure units
0571-0572	7486	Static pressure device reading 6	RO	Static pressure units
0573-0574	7487	Static pressure verification reference point 6	RW	Static pressure units
0575-0576	7488	Process temperature device reading 1	RO	Process temperature units
0577-0578	7489	Process temperature verification reference point 1	RW	Process temperature units
0579-0580	7490	Process temperature device reading 2	RO	Process temperature units
0581-0582	7491	Process temperature verification reference point 2	RW	Process temperature units
0583-0584	7492	Process temperature device reading 3	RO	Process temperature units
0585-0586	7493	Process temperature verification reference point 3	RW	Process temperature units
0587-0588	7494	Process temperature device reading 4	RO	Process temperature units
0589-0590	7495	Process temperature verification reference point 4	RW	Process temperature units
0591-0592	7496	Process temperature device reading 5	RO	Process temperature units
0593-0594	7497	Process temperature verification reference point 5	RW	Process temperature units



Table 4-12. Floating Point Registers

Register number (16-bit)	Register number (32-bit)	Register name	Access type	Units
0595–0596	7498	Process temperature device reading 6	RO	Process temperature units
0597–0598	7499	Process temperature verification reference point 6	RW	Process temperature units
0599–0600	7500	Differential pressure offset	RW	Differential pressure units
0601–0602	7501	Differential pressure minimum span	RO	Differential pressure units
0613–0614	7507	Process temperature offset	RW	Process temperature units
0615–0616	7508	Process temperature minimum span	RO	Process temperature units
0627–0628	7514	Static pressure offset	RW	Static pressure units
0629–0630	7515	Static pressure minimum span	RO	Static pressure units
0641–0642	7521	Simulate differential pressure	RW	Differential pressure units
0643–0644	7522	Simulate static pressure	RW	Static pressure units
0645–0646	7523	Simulate process temperature	RW	Process temperature units
0647–0648	7524	Simulate sensor module temperature	RW	Sensor module temperature units
0651–0652	7526	Sensor module temperature minimum span	RO	Sensor module temperature units

## 4.2 Rosemount 4088B ROC communications

The Rosemount 4088B is designed to provide a seamless transition from the legacy MVS205 sensor. It has been designed to be used with the ROCLINK™ 800 configuration software (either by itself or launched through OpenEnterprise Field Tools) to configure and (if necessary) calibrate the Rosemount 4088B.

For further information on the FloBoss™ 107, refer to:

- FloBoss 107 Flow Manager Instruction Manual (part D301232X012)
- ROCLINK 800 Configuration Software User Manual (for FloBoss 107) (part D301249X012)

For further information on the ROC800-Series devices, refer to:

- ROC800-Series Remote Operations Controller Instruction Manual (part D301217X012)
- DL8000 Preset Controller Instruction Manual (part D301244X012)
- ROCLINK 800 Configuration Software User Manual (for ROC800-Series) (part D301250X012)
- ROCLINK 800 Configuration Software User Manual (for DL8000) (part D301259X012)
- ROCLINK 800 Configuration Software User Manual (for ROC800L) (part D301246X012)

For further information on communication protocols, refer to:

- For the FloBoss 107: ROC Protocol Specifications Manual (part D301053X012)
- For the ROC800-Series: ROC Plus Protocol Specifications Manual (part D301180X012)
- For the DL8000: Preset Protocol Specifications Manual (part D301254X012)
- For the ROC800L: ROC800L Protocol Specifications Manual (part D301659X012)

## 4.3 Rosemount 4088B BSAP communications

Depending on system setup, the ControlWave™ application may need to be modified to work with the Rosemount 4088B Transmitter.

---

### Note

This section assumes familiarity with ControlWave Designer and the user knows how to edit ControlWave Designer projects and download a ControlWave project into the ControlWave. If unfamiliar with these topics, see Getting Started with ControlWave Designer part D301416X012, the online help in ControlWave Designer, and the ControlWave Designer Programmer's Handbook part D301426X012. For information on TechView, see the TechView User's Guide part D301430X012. For information on OpenEnterprise Field Tools, see the OE Field Tools Quick Start Guide part D301703X412.

---

When using TechView by itself (or launched through OpenEnterprise Field Tools) to communicate with one or more Rosemount 4088B transmitters that are connected to the RS-485 port of a ControlWave device, modify the ControlWave application to handle the direct communication with the transmitter(s) if any of the following are true:

- ControlWave is used as a data concentrator which collects data from the transmitter(s) which can then be polled from a higher level controller or host computer
- Data from the transmitter(s) in the program logic is running in the ControlWave
- The connection between the PC/laptop running TechView/Field Tools uses Ethernet instead of a serial connection

In all of these cases, TechView communicates locally with the ControlWave device and the application running in the ControlWave device handles the direct connection to the Rosemount 4088B transmitter(s). The application must use the CLIENT function block to collect the appropriate list(s) from the Rosemount 4088B. For details on configuring the CLIENT function block, see the online help in ControlWave Designer.

If connecting serially to the ControlWave device without using data from the transmitters in the ControlWave application or using the ControlWave device as a data concentrator, remote access can be used to communicate through the ControlWave Micro port directly to the transmitter(s). This does not require application modification. Once communications are established with TechView, call up web pages or launch DataView to access particular lists.

### 4.3.1 Rosemount 4088B BSAP communications signals

Table 4-14 shows each of the lists that reside in the Rosemount 4088B. To use data from these lists in the ControlWave project, the CLIENT function block needs to be configured to retrieve the lists. The LIST number to retrieve must be specified on the iiServerID parameter of the CLIENT function block.

---

### Note

Some variables in the lists are identified for "3808 legacy support." These variables are not functional and exist only for 3808 list compatibility.

---

---

### Important

To collect dynamic process information (pressure, temperature) at a rate of up to once per second, only collect List 1 or List 101. Collect other lists only when specifically needed, otherwise data update rates for calculations may be slower.

---

Table 4-13. Control Bits Definitions

Control bit	Description
LK	Software write protection bit, signals with the LK bit are write protected when MANUAL.LOCK.CFG is set to 1 and write enabled when set to 0. MANUAL.LOCK.CFG is writeable, via BSAP, over the local port only. This parameter has no impact on any other protocol.
MI	Manual Inhibit - when set, this bit prevents the user from writing to the BSAP signal.
N/A	Designates control bit that is not applicable.

Table 4-14. Rosemount 4088B BSAP Signal Information

List	Index	BSAP signal	Name	Access type	Control bits	Description
1	1	PRESSURE.VAL.INP	Pressure	RO	MI	Value given in pressure units
1	2	STATIC.VAL.INP	Static Pressure	RO	MI	Value given in static pressure units
1	3	TEMP.VAL.INP	Process Temperature	RO	MI	Value given in process temperature units
1	4	ESTTEMP.VAL.LIVE	Sensor Module Temperature	RO	MI	Value given in sensor module temperature units
1	5	ERRFLAGS	Transmitter Status	RO	None	Possible values are: 0.5 = No errors 0.53125 = Power failure 0.50390625 = Process temperature out of limit or process temperature sensor failure 0.53515625 = Power failure and process temperature out of limit or process temperature sensor failure
2	1	PRESSURE.UNITS.	Pressure Units	RW	LK	0 = psi 1 = kPa 2 = MPa 3 = mmH <sub>2</sub> O 4 = inH <sub>2</sub> O @ 60°F 5 = mmHg 6 = inHg 7 = mbar 8 = bar 9 = g/cm <sup>2</sup> 10 = kg/cm <sup>2</sup> 11 = ftH <sub>2</sub> O 12 = inH <sub>2</sub> O @ 68 °F 13 = Pa 14 = torr 15 = atm 16 = inH <sub>2</sub> O @ 4 °C 17 = mmH <sub>2</sub> O @ 4 °C
2	2	STATIC.UNITS.	Static Pressure Units	RW	LK	0 = psi 1 = kPa 2 = MPa 3 = mmH <sub>2</sub> O 4 = inH <sub>2</sub> O @ 60°F 5 = mmHg 6 = inHg 7 = mbar 8 = bar 9 = g/cm <sup>2</sup> 10 = kg/cm <sup>2</sup> 11 = ftH <sub>2</sub> O 12 = inH <sub>2</sub> O @ 68 °F 13 = Pa 14 = torr 15 = atm 16 = inH <sub>2</sub> O @ 4 °C 17 = mmH <sub>2</sub> O @ 4 °C
2	3	TEMP.UNITS.	Process Temperature Units	RW	LK	0 = °C 1 = °F
2	4	TEMP.UNITS.	Process Temperature Units	RW	LK	0 = °C 1 = °F
2	5	TAGNAME.	Tag	RW	LK	This field can hold numbers, symbols, and uppercase letters (8 characters).

**Table 4-14. Rosemount 4088B BSAP Signal Information**

List	Index	BSAP signal	Name	Access type	Control bits	Description
2	6	REV3508.	N/A	N/A	MI	3808 legacy support
3	1	PRESSURE.SPAN.CAL	Pressure Upper Trim	RW	None	User-entered pressure during 2-point span trim in pressure units
4	1	STATIC.SPAN.CAL	Static Pressure Upper Trim	RW	None	User-entered pressure during 2-point SP span trim in static pressure units
5	1	EXECUTE.CALIB.	Calibration command	RW	LK	0 = No operation 1 = Dp zero 2 = Dp span. Input is PRESSURE.SPAN.CAL 3 = Sp zero 4 = Sp span. Input is STATIC.SPAN.CAL 5 = RTD zero (expects 100 ohm resistor on RTD) 6 = RTD span (expects 300 ohm resistor on RTD)
5	2	MODBUS.CALIB.	Calibration in progress	RW	LK	The host is responsible for setting this flag; the device does not change the value. OFF = Calibration not in progress ON = Calibration in progress
6	1	PRESSURE.TARGET.	Pressure upper trim point	RW	LK	Value given in pressure units
6	2	STATIC.TARGET.	Static pressure upper trim point	RW	LK	Value given in static pressure units
7	1	TEMP.OFFSET.CFG	N/A	N/A	LK	3808 legacy support
8	1	A.USER.CAL	Process temperature Callendar-Van Dusen "A"	RW	LK	N/A
8	2	B.USER.CAL	Process temperature Callendar-Van Dusen "B"	RW	LK	N/A
8	3	R0.USER.CAL	Process temperature Callendar-Van Dusen "R0"	RW	LK	N/A
9	1	TEMP.SPAN.CAL	Process temperature Upper Trim Point	RW	LK	Value given in process temperature units

Table 4-14. Rosemount 4088B BSAP Signal Information

List	Index	BSAP signal	Name	Access type	Control bits	Description
10	1	PRESSURE.UNITS.	Pressure units	RW	LK	0 = psi 1 = kPa
10	2	STATIC.UNITS.	Static pressure units	RW	LK	2 = MPa 3 = mmH <sub>2</sub> O @ 68 °F 4 = inH <sub>2</sub> O @ 60 °F 5 = mmHg @ 0 °C 6 = inHg @ 0 °C 7 = mbar 8 = bar 9 = g/cm <sup>2</sup> 10 = kg/cm <sup>2</sup> 11 = ftH <sub>2</sub> O @ 68 °F 12 = inH <sub>2</sub> O @ 68 °F 13 = Pa 14 = torr 15 = atm 16 = inH <sub>2</sub> O @ 4 °C 17 = mmH <sub>2</sub> O @ 4 °C
10	3	TEMP.UNITS.	Process temperature units	RW	LK	0 = °C 1 = °F
10	4	OUTPUT.SOURCE.	N/A	N/A	None	3808 legacy support
10	5	OUTPUT.VAL.EXT	N/A	N/A	None	3808 legacy support
10	6	OUTPUT.VAL.LRV	N/A	N/A	None	3808 legacy support
10	7	OUTPUT.VAL.URV	N/A	N/A	None	3808 legacy support
10	8	BSAP.ADDR.CFG	BSAP Local address	RW	LK	BSAP local address of the transmitter (1–126)
10	9	BSAP.GROUP.CFG	EBSAP Group number	RW	LK	EBSAP group number (0–127) - leave at 0 unless using EBSAP
10	10	MODBUS.ADDR.CFG	Device address	RW	LK	Valid addresses are 1–239
10	11	MODBUS.MODE.CFG	N/A	N/A	MI	3808 legacy support
10	12	BAUDRATE.CFG.	Baud rate	RW	LK	485 port baud rate: 1200 2400 4800 9600 19200
10	13	RTS.DELAY.CFG	Turnaround delay time (ms)	RW	None	N/A
10	14	TEMP.VAL.DAMP	Process temperature damping	RW	None	Value given in seconds
10	15	A.USER.CAL	Process temperature Callendar-Van Dusen "A"	RW	LK	N/A

**Table 4-14. Rosemount 4088B BSAP Signal Information**

List	Index	BSAP signal	Name	Access type	Control bits	Description												
10	16	B.USER.CAL	Process temperature Callendar-Van Dusen "B"	RW	LK	N/A												
10	17	R0.USER.CAL	Process temperature Callendar-Van Dusen "R0"	RW	LK	N/A												
10	18	RTD.ZERO.CAL	N/A	N/A	LK	3808 legacy support												
10	19	PRESSURE.VAL.DAMP	Pressure damping	RW	None	Value given in seconds												
10	20	STATIC.VAL.DAMP	Static pressure damping	RW	None	Value given in seconds												
10	21	PRESSURE.VAL.LRV	Pressure lower alert limit	RW	LK	Value given in pressure units												
10	22	PRESSURE.VAL.URV	Pressure upper alert limit	RW	LK	Value given in pressure units												
10	23	TEMP.VAL.LRV	Process temperature lower alert limit	RW	LK	Value given in process temperature units												
10	24	TEMP.VAL.URV	Process temperature upper alert limit	RW	LK	Value given in process temperature units												
10	25	STATIC.VAL.LRV	Static pressure lower alert limit	RW	LK	Value given in static pressure units												
10	26	STATIC.VAL.URV	Static pressure upper alert limit	RW	LK	Value given in static pressure units												
10	27	OUTPUT.FAIL.	N/A	N/A	None	3808 legacy support												
10	28	TEMP.FAIL.	Temperature mode	RW	LK	When TEMP.FAIL is written, the following values will be automatically loaded into TEMP.MODE: <table border="0" style="margin-left: 20px;"> <tr> <td>Fail to mode</td> <td>TEMP.MODE</td> <td>TEMP.FAIL</td> </tr> <tr> <td>FIXED value</td> <td>0</td> <td>0</td> </tr> <tr> <td>Backup value when RTD fails</td> <td>1</td> <td>1</td> </tr> <tr> <td>Normal RTD operation</td> <td>1</td> <td>2</td> </tr> </table>	Fail to mode	TEMP.MODE	TEMP.FAIL	FIXED value	0	0	Backup value when RTD fails	1	1	Normal RTD operation	1	2
Fail to mode	TEMP.MODE	TEMP.FAIL																
FIXED value	0	0																
Backup value when RTD fails	1	1																
Normal RTD operation	1	2																
10	29	TEMP.FAIL.CFG	Backup/Fixed process temperature	RW	LK	Value given in process temperature units												
10	30	BSAP.ANYADR.CFG	Local port response selectivity	RW	None	0 = Respond only for this transmitter's address 1 = Respond to any address												
10	31	TEMP.OFFSET.CFG	N/A	N/A	LK	3808 legacy support												

Table 4-14. Rosemount 4088B BSAP Signal Information

List	Index	BSAP signal	Name	Access type	Control bits	Description									
10	32	MANUAL.LOCK.CFG	BSAP write protection	RW	None	BSAP write protection 0 = Write enabled 1 = Write protected When set to 1, BSAP signals, with the LK in the signal control bits, are write-protected over the network port only. When set to 0, these signals are write-enabled. MANUAL.LOCK.CFG is writable, via BSAP, over the local port only.									
10	33	CU.SEL.CFG	N/A	N/A	LK	3808 legacy support									
10	34	CU.LRV.CFG	N/A	N/A	LK	3808 legacy support									
10	35	CU.URV.CFG	N/A	N/A	LK	3808 legacy support									
10	36	STATIC.LRLADJ.CFG	N/A	N/A	None	3808 legacy support									
10	37	STATIC.MODE.	Static mode	RW	None	If enabled, then AP displays on LCD display. 0 = Disabled 1 = Enabled									
10	38	TEMP.MODE.	Process temperature present	RW	LK	OFF = Disabled (Fixed RTD mode) ON = Enabled (Normal/Backup mode) When TEMP.MODE is written, the following value will be automatically loaded into TEMP.FAIL: <table border="1" style="margin-left: 20px;"> <tr> <td>Fail to mode</td> <td>TEMP.MODE</td> <td>TEMP.FAIL</td> </tr> <tr> <td>FIXED value</td> <td>0</td> <td>0</td> </tr> <tr> <td>Backup value when RTD fails</td> <td>1</td> <td>1</td> </tr> </table>	Fail to mode	TEMP.MODE	TEMP.FAIL	FIXED value	0	0	Backup value when RTD fails	1	1
Fail to mode	TEMP.MODE	TEMP.FAIL													
FIXED value	0	0													
Backup value when RTD fails	1	1													
10	39	OUTPUT.ACTION.	N/A	N/A	None	3808 legacy support									
10	40	OUTPUT.MODE.	N/A	N/A	None	3808 legacy support									
10	41	PW.	N/A	RW	MI+LK	Password for write access to the transmitter via BSAP									
10	42	TAGNAME..	Tag	RW	LK	This field can hold numbers, symbols, and uppercase letters (8 characters)									
10	43	SENSOR.TYPE.CODE	Sensor module type	RO	MI	2 = Absolute (AP) 6 = DP with AP high side static pressure 7 = DP with GP high side static pressure 12 = Gage pressure (GP) 32 = Differential pressure (DP) 253 = Custom									
11	1	PRESSURE.RESTR.DEF	Restore pressure factory calibration	RW	LK	OFF = No action ON = Reset pressure trims to factory default									
11	2	STATIC.RESTR.DEF	Restore static pressure factory calibration	RW	LK	OFF = No action ON = Reset static pressure trims to factory default									
11	3	TEMP.RESTR.DEF	Restore process temperature factory calibration	RW	LK	OFF = No action ON = Reset process temperature trims to factory default									
80	1	PROGREV..	N/A	N/A	MI	3808 legacy support									
80	2	PRESSURE.SPAN.CAL	Pressure upper trim	RW	None	User-entered pressure during 2-point span trim in pressure units									

**Table 4-14. Rosemount 4088B BSAP Signal Information**

List	Index	BSAP signal	Name	Access type	Control bits	Description
80	3	STATIC.SPAN.CAL	Static pressure upper trim	RW	None	User-entered pressure during 2-point SP span trim in static pressure units
80	4	PRESSURE.VAL.LRV	Pressure lower alert limit	RW	LK	Value given in pressure units
80	5	PRESSURE.VAL.URV	Pressure upper alert limit	RW	LK	Value given in pressure units
80	6	TEMP.VAL.LRV	Process temperature lower alert limit	RW	LK	Value given in process temperature units
80	7	TEMP.VAL.URV	Process temperature upper alert limit	RW	LK	Value given in process temperature units
80	8	PRESSURE.VAL.LRL	Pressure lower sensor limit	RO	MI	Value given in pressure units
80	9	PRESSURE.VAL.URL	Pressure upper sensor limit	RO	MI	Value given in pressure units
80	10	STATIC.VAL.LRL	Static pressure lower sensor limit (for installed sensor)	RO	MI	Value given in static pressure units
80	11	STATIC.VAL.URL	Static pressure upper sensor limit (for installed sensor)	RO	MI	Value given in static pressure units
80	12	STATIC.VAL.LRV	Static pressure lower alert Limit	RW	LK	Value given in static pressure units
80	13	STATIC.VAL.URV	Static pressure upper alert limit	RW	LK	Value given in static pressure units
80	14	PRESSURE.TARGET.	Pressure upper trim point	RW	LK	Value given in pressure units
80	15	STATIC.TARGET.	Static pressure upper trim point	RW	LK	Value given in static pressure units
80	16	SENSOR.BLOCK.NUM	Sensor module serial number	RO	MI	Sensor module serial number
80	17	BOARD.SERIAL.NUM	Electronics board serial number	RO	MI	Electronics board serial number
101	1	PRESSURE.VAL.INP	Pressure	RO	MI	Value given in pressure units
101	2	STATIC.VAL.INP	Static pressure	RO	MI	Value given in static pressure units
101	3	TEMP.VAL.INP	Process temperature	RO	MI	Value given in process temperature units
101	4	ESTTEMP.VAL.LIVE	Sensor module temperature	RO	MI	Value given in sensor module temperature units



Table 4-14. Rosemount 4088B BSAP Signal Information

List	Index	BSAP signal	Name	Access type	Control bits	Description												
101	5	ERRFLAGS..	Transmitter status	RO	None	Possible values are: 0.5 = No errors 0.53125 = Power failure 0.50390625 = Process temperature out of limit or process temperature sensor failure 0.53515625 = Power failure and process temperature out of limit or process temperature sensor failure												
101	6	CONFIG.CHANGE.CNTR	Configuration change counter	RO	None	Count of configuration/calibration changes received												
101	7	PRESSURE.VAL.LIVE	N/A	N/A	MI	3808 legacy support												
101	8	STATIC.VAL.LIVE	N/A	N/A	MI	3808 legacy support												
101	9	TEMP.FAIL.	Temperature mode	RW	LK	When TEMP.FAIL is written, the following values will be automatically loaded into TEMP.MODE: <table border="1"> <thead> <tr> <th>Fail to mode</th> <th>TEMP.MODE</th> <th>TEMP.FAIL</th> </tr> </thead> <tbody> <tr> <td>FIXED value</td> <td>0</td> <td>0</td> </tr> <tr> <td>Backup value when RTD fails</td> <td>1</td> <td>1</td> </tr> <tr> <td>Normal RTD operation</td> <td>1</td> <td>2</td> </tr> </tbody> </table>	Fail to mode	TEMP.MODE	TEMP.FAIL	FIXED value	0	0	Backup value when RTD fails	1	1	Normal RTD operation	1	2
Fail to mode	TEMP.MODE	TEMP.FAIL																
FIXED value	0	0																
Backup value when RTD fails	1	1																
Normal RTD operation	1	2																
101	10	STATUS.OPTNS.	Device configuration	RO	MI	Sum of one or more of the following values: 1 = DP sensor installed 2 = AP pressure installed 4 = GP pressure installed 8 = PT sensor installed 16 = LCD display present 32 = 4088 mode B 64 = N/A 128 = N/A For example, 33 = DP sensor installed (1) plus 4088 Mode B (32)												
101	11	DP.STATUS.	Differential pressure variable status	RO	MI	Status Format: Measurement Quality - Limit Status 0 = Bad - Not limited 16 = Bad - Low limited 32 = Bad - High limited												
101	12	SP.STATUS.	Static pressure variable status	RO	MI	48 = Bad - Constant 64 = Poor Accuracy - Not limited												
101	13	PT.STATUS.	Process temperature variable status	RO	MI	80 = Poor Accuracy - Low limited 96 = Poor Accuracy - High limited 112 = Poor Accuracy - Constant 128 = Manual/Fixed - Not limited												
101	14	ST.STATUS.	Sensor module temperature variable status	RO	MI	144 = Manual/Fixed - Low limited 160 = Manual/Fixed - High limited 176 = Manual/Fixed - Constant 192 = Good - Not limited 208 = Good - Low limited 224 = Good - High limited 240 = Good - Constant												

**Table 4-14. Rosemount 4088B BSAP Signal Information**

List	Index	BSAP signal	Name	Access type	Control bits	Description
102	1	PRESSURE.UNITS.	Pressure units	RW	LK	0 = psi 1 = kPa
102	2	STATIC.UNITS.	Static pressure units	RW	LK	2 = MPa 3 = mmH <sub>2</sub> O @ 68 °F 4 = inH <sub>2</sub> O @ 60 °F 5 = mmHg @ 0 °C 6 = inHg @ 0 °C 7 = mbar 8 = bar 9 = g/cm <sup>2</sup> 10 = kg/cm <sup>2</sup> 11 = ftH <sub>2</sub> O @ 68 °F 12 = inH <sub>2</sub> O @ 68 °F 13 = Pa 14 = torr 15 = atm 16 = inH <sub>2</sub> O @ 4 °C 17 = mmH <sub>2</sub> O @ 4 °C
102	3	TEMP.UNITS.	Process temperature units	RW	LK	0 = °C 1 = °F
102	4	TEMP.UNITS.	Process temperature units	RW	LK	0 = °C 1 = °F
102	5	TAGNAME..	Tag	RW	LK	This field can hold numbers, symbols, and uppercase letters (8 characters)
102	6	REV3508..	N/A	N/A	MI	3808 legacy support
102	7	DESCRIP.USER.CFG	Description	RW	LK	This field can hold numbers, symbols, and uppercase letters (16 characters)
102	8	MESSAGE.USER.CFG	Message	RW	LK	This field can hold numbers, symbols, and uppercase letters (32 characters)
102	9	HART.LONG.TAG	Long tag	RW	LK	ISO-Latin-1 (32 characters)
102	10	XMT.TYPE.CFG	Device model	RO	MI	9832 = 0x2668 hex 1st byte is manufacture id (RMT = 26 hex) 2nd byte is device type (68 hex)
102	11	HW.WRITE.PROT	Transmitter security switch status	RO	MI	OFF = Disabled ON = Enabled
102	12	ST.UNITS.	Sensor module temperature units	RW	LK	0 = °C 1 = °F
103	1	PRESSURE.SPAN.CAL	Pressure upper trim	RW	None	User-entered pressure during 2-point span trim in pressure units
104	1	STATIC.SPAN.CAL	Static pressure upper trim	RW	None	User-entered pressure during 2-point SP span trim in static pressure units

**Table 4-14. Rosemount 4088B BSAP Signal Information**

List	Index	BSAP signal	Name	Access type	Control bits	Description
105	1	EXECUTE.CALIB.	Calibration command	RW	LK	0 = No Operation 1 = Dp zero 2 = Dp span. Input is PRESSURE.SPAN.CAL 3 = Sp zero 4 = Sp span. Input is STATIC.SPAN.CAL 5 = RTD zero (expects 100 ohm resistor on RTD) 6 = RTD span (expects 300 ohm resistor on RTD)
105	2	MODBUS.CALIB.	Calibration in progress	RW	LK	The host is responsible for setting this flag; the device does not change the value. OFF = Calibration not in progress ON = Calibration in progress
106	1	PRESSURE.TARGET.	Pressure upper trim point	RW	LK	Value given in pressure units
106	2	STATIC.TARGET.	Static pressure upper trim point	RW	LK	Value given in static pressure units
107	1	TEMP.OFFSET.CFG	N/A	N/A	LK	3808 legacy support
108	1	A.USER.CAL	Process temperature Callendar-Van Dusen "A"	RW	LK	N/A
108	2	B.USER.CAL	Process temperature Callendar-Van Dusen "B"	RW	LK	N/A
108	3	R0.USER.CAL	Process temperature Callendar-Van Dusen "R0"	RW	LK	N/A
108	4	C.USER.CAL	Process temperature Callendar-Van Dusen "C"	RW	LK	N/A
109	1	TEMP.SPAN.CAL	Process temperature Upper Trim Point	RW	LK	Value given in process temperature units
109	2	USER.SPAN.CAL	Legacy calibration process temperature upper trim point	RO	LK	Value given in process temperature units

**Table 4-14. Rosemount 4088B BSAP Signal Information**

List	Index	BSAP signal	Name	Access type	Control bits	Description
110	1	PRESSURE.UNITS.	Pressure units	RW	LK	0 = psi 1 = kPa 2 = MPa 3 = mmH <sub>2</sub> O @ 68 °F 4 = inH <sub>2</sub> O @ 60 °F 5 = mmHg @ 0 °C 6 = inHg @ 0 °C 7 = mbar 8 = bar 9 = g/cm <sup>2</sup> 10 = kg/cm <sup>2</sup> 11 = ftH <sub>2</sub> O @ 68 °F 12 = inH <sub>2</sub> O @ 68 °F 13 = Pa 14 = torr 15 = atm 16 = inH <sub>2</sub> O @ 4 °C 17 = mmH <sub>2</sub> O @ 4 °C
110	2	STATIC.UNITS.	Static pressure units	RW	LK	
110	3	TEMP.UNITS.	Process temperature units	RW	LK	0 = °C 1 = °F
110	4	OUTPUT.SOURCE.	N/A	N/A	None	3808 legacy support
110	5	OUTPUT.VAL.EXT	N/A	N/A	None	3808 legacy support
110	6	OUTPUT.VAL.URV	N/A	N/A	None	3808 legacy support
110	7	OUTPUT.VAL.URV	N/A	N/A	None	3808 legacy support
110	8	BSAP.ADDR.CFG	BSAP local address	RW	LK	BSAP local address of the Rosemount 4088B (1–126)
110	9	BSAP.GROUP.CFG	EBSAP group number	RW	LK	EBSAP group number (0–127). Leave at 0 unless using EBSAP
110	10	MODBUS.ADDR.CFG	Device address	RW	LK	Valid addresses are 1–239
110	11	MODBUS.MODE.CFG	N/A	N/A	MI	(3808 legacy support)
110	12	BAUDRATE.CFG.	Baud rate	RW	LK	485 port baud rate: 1200 2400 4800 9600 19200
110	13	RTS.DELAY.CFG	Turnaround delay time (ms)	RW	None	N/A
110	14	TEMP.VAL.DAMP	Process temperature damping	RW	None	Value given in seconds
110	15	A.USER.CAL	Process temperature Callendar-Van Dusen “A”	RW	LK	N/A

**Table 4-14. Rosemount 4088B BSAP Signal Information**

List	Index	BSAP signal	Name	Access type	Control bits	Description												
110	16	B.USER.CAL	Process temperature Callendar-Van Dusen "B"	RW	LK	N/A												
110	17	R0.USER.CAL	Process temperature Callendar-Van Dusen "R0"	RW	LK	N/A												
110	18	RTD.ZERO.CAL	N/A	N/A	LK	3808 legacy support												
110	19	PRESSURE.VAL.DAMP	Pressure damping	RW	None	Value given in seconds												
110	20	STATIC.VAL.DAMP	Static pressure damping	RW	None	Value given in seconds												
110	21	PRESSURE.VAL.LRV	Pressure lower alert limit	RW	LK	Value given in pressure units												
110	22	PRESSURE.VAL.URV	Pressure upper alert limit	RW	LK	Value given in pressure units												
110	23	TEMP.VAL.LRV	Process temperature lower alert limit	RW	LK	Value given in process temperature units												
110	24	TEMP.VAL.URV	Process temperature upper alert limit	RW	LK	Value given in process temperature units												
110	25	STATIC.VAL.LRV	Static pressure lower alert limit	RW	LK	Value given in static pressure units												
110	26	STATIC.VAL.URV	Static pressure upper alert limit	RW	LK	Value given in static pressure units												
110	27	OUTPUT.FAIL.	N/A	N/A	None	3808 legacy support												
110	28	TEMP.FAIL.	Temperature mode	RW	LK	When TEMP.FAIL is written, the following values will be automatically loaded into TEMP.MODE: <table border="0" style="margin-left: 20px;"> <tr> <td>Fail to mode</td> <td>TEMP.MODE</td> <td>TEMP.FAIL</td> </tr> <tr> <td>FIXED value</td> <td>0</td> <td>0</td> </tr> <tr> <td>Backup value when RTD fails</td> <td>1</td> <td>1</td> </tr> <tr> <td>Normal RTD operation</td> <td>1</td> <td>2</td> </tr> </table>	Fail to mode	TEMP.MODE	TEMP.FAIL	FIXED value	0	0	Backup value when RTD fails	1	1	Normal RTD operation	1	2
Fail to mode	TEMP.MODE	TEMP.FAIL																
FIXED value	0	0																
Backup value when RTD fails	1	1																
Normal RTD operation	1	2																
110	29	TEMP.FAIL.CFG	Backup/Fixed process temperature	RW	LK	Value given in process temperature units												
110	30	BSAP.ANYADR.CFG	Local port response selectivity	RW	None	0 = Respond only for this transmitter's address 1 = Respond to any address												
110	31	TEMP.OFFSET.CFG	N/A	N/A	LK	3808 legacy support												

**Table 4-14. Rosemount 4088B BSAP Signal Information**

List	Index	BSAP signal	Name	Access type	Control bits	Description									
110	32	MANUAL.LOCK.CFG	BSAP Write protection	RW	None	BSAP write protection 0 = Write enabled 1 = Write protected When set to 1, BSAP signals with a lock bit are write-protected over the network port only. When set to 0, these signals are write-enabled. MANUAL.LOCK.CFG is writable, via BSAP, over the local port only. Only the signals with LK in the Control Bits column can be locked.									
110	33	CU.SEL.CFG	N/A	N/A	LK	3808 legacy support									
110	34	CU.LRV.CFG	N/A	N/A	LK	3808 legacy support									
110	35	CU.URV.CFG	N/A	N/A	LK	3808 legacy support									
110	36	STATIC.LRLADJ.CFG	N/A	N/A	None	3808 legacy support									
110	37	STATIC.MODE.	Static mode	RW	None	If enabled, then AP displays on LCD display. 0 = Disabled 1 = Enabled									
110	38	TEMP.MODE.	Process temperature present	RW	LK	OFF = Disabled (Fixed RTD mode) ON = Enabled (Normal/Backup mode) When TEMP.MODE is written, the following value will be automatically loaded into TEMP.FAIL: <table border="1" style="margin-left: 20px;"> <tr> <td>Fail to mode</td> <td>TEMP.MODE</td> <td>TEMP.FAIL</td> </tr> <tr> <td>FIXED value</td> <td>0</td> <td>0</td> </tr> <tr> <td>Backup value when RTD fails</td> <td>1</td> <td>1</td> </tr> </table>	Fail to mode	TEMP.MODE	TEMP.FAIL	FIXED value	0	0	Backup value when RTD fails	1	1
Fail to mode	TEMP.MODE	TEMP.FAIL													
FIXED value	0	0													
Backup value when RTD fails	1	1													
110	39	OUTPUT.ACTION.	N/A	N/A	None	3808 legacy support									
110	40	OUTPUT.MODE.	N/A	N/A	None	3808 legacy support									
110	41	PW..	N/A	RW	MI+LK	The password for write access to the transmitter via BSAP									
110	42	TAGNAME..	Tag	RW	LK	This field can hold numbers, symbols, and uppercase letters (8 characters)									
110	43	SENSOR.TYPE.CODE	Sensor module type	RO	MI	2 = Absolute pressure (AP) 6 = DP with AP high side static pressure 7 = DP with GP high side static pressure 12 = Gage pressure (GP) 32 = Differential pressure (DP) 253 = Custom									
110	44	C.USER.CAL	Process temperature Callendar-Van Dusen "C"	RW	LK	N/A									
110	45	RTD.MIN.SPAN	Process temperature minimum span	RO	MI	Value given in process temperature units									
110	46	TEMP.ZERO.CAL	Process temperature lower trim point	RW	LK	Value given in process temperature units									

**Table 4-14. Rosemount 4088B BSAP Signal Information**

List	Index	BSAP signal	Name	Access type	Control bits	Description
110	47	DP.CUTOFF.LOW	Differential pressure low dp cutoff	RW	LK	Value given in differential pressure units
110	48	ATMOS.PRESS.	User-Defined atmospheric pressure	RW	LK	Value given in static pressure units
110	49	ST.URV.	Sensor module temperature lower alert limit	RW	LK	Value given in sensor module temperature units
110	50	ST.LRV.	Sensor module temperature upper alert limit	RW	LK	Value given in sensor module temperature units
110	51	ST.UNITS.	Sensor module temperature units	RW	LK	0 = °C 1 = °F
110	52	TXMITTER.FAIL.	N/A	N/A	None	3808 legacy support
110	53	USER.ZERO.CAL	Legacy calibration process temperature lower trim point	RO	LK	Value given in process temperature units
110	54	ST.MIN.SPAN	Sensor module temperature minimum span	RO	MI	Value given in sensor module temperature units
110	55	CONFIG.CHANGE.CNTR	Configuration change counter	RO	None	Count of configuration/calibration changes received
111	1	PRESSURE.RESTR.DEF	Restore pressure factory calibration	RW	LK	OFF = No action ON = Reset pressure trims and calibrations to factory default
111	2	STATIC.RESTR.DEF	Restore static pressure factory calibration	RW	LK	OFF = No action ON = Reset static pressure trims and calibrations to factory default
111	3	TEMP.RESTR.DEF	Restore process temperature factory calibration	RW	LK	OFF = No action ON = Reset process temperature trims and calibrations to factory default
111	4	RESTR.CVD.COEF	Reset Callendar-Van Dusen to IEC 751 defaults	RW	LK	OFF = No action ON = Reset Callendar-Van Dusen to IEC 751 Defaults
112	1	BSAP.ADDR.CFG	BSAP Local address	RW	LK	BSAP local address of the transmitter (1–126)
112	2	BSAP.GROUP.CFG	EBSAP Group number	RW	LK	EBSAP group number (0–127). Leave at 0 unless using EBSAP
112	3	BSAP.ANYADR.CFG	Local port response selectivity	RW	None	0 = Respond only for this transmitter's address 1 = Respond to any address

**Table 4-14. Rosemount 4088B BSAP Signal Information**

List	Index	BSAP signal	Name	Access type	Control bits	Description
112	4	MODBUS.ADDR.CFG	Device address	RW	LK	Valid addresses are 1–239
112	5	RTS.MODE.	N/A	N/A	None	3808 legacy support
112	6	RTS.DELAY.CFG	Turnaround delay time (ms)	RW	None	N/A
112	7	BAUDRATE.CFG.	Baud rate	RW	LK	485 port baud rate: 1200 2400 4800 9600 19200
115	2	SET.CAL.TYPE	Calibration type	RW	LK	0 - None 1 - Set lower trim 2 - Set upper trim 6 - Sensor setup 7 - Sensor restore
115	3	SET.CAL.VAL	Calibration set value	RW	LK	N/A
117	1	SP_AP.USER.VAL	Absolute pressure	RO	MI	Value given in static pressure units
117	2	SP_GP.USER.VAL	Gage pressure	RO	MI	Value given in static pressure units
117	3	STATIC.VAL.LIVE	N/A	N/A	MI	3808 legacy support
117	4	SP.STATUS.	Static pressure variable status	RO	MI	Status format: Measurement quality - Limit status 0 = Bad - Not limited 16 = Bad - Low limited 32 = Bad - High limited 48 = Bad - Constant 64 = Poor accuracy - Not limited 80 = Poor accuracy - Low limited 96 = Poor accuracy - High limited 112 = Poor accuracy - Constant 128 = Manual/Fixed - Not limited 144 = Manual/Fixed - Low limited 160 = Manual/Fixed - High limited 176 = Manual/Fixed - Constant 192 = Good - Not limited 208 = Good - Low limited 224 = Good - High limited 240 = Good - Constant
119	1	ISOLAT.XMIT.CFG	Isolating diaphragm material	RO	LK	2 = 316L Stainless Steel 3 = Alloy C-276 4 = Alloy 400 5 = Tantalum 15 = Gold-plated Alloy 400 34 = Gold-plated 316L SST 35 = Gold plated Alloy C-276 253 = Special
119	2	FLUID.XMIT.CFG	Sensor module fill fluid	RO	LK	1 = Silicone 2 = Inert 7 = Neobee 252 = Unknown 253 = Special



Table 4-14. Rosemount 4088B BSAP Signal Information

List	Index	BSAP signal	Name	Access type	Control bits	Description
119	3	FLANGE.MATL.CFG	Process connection material	RW	LK	0 = Carbon Steel 2 = 316 Stainless Steel 3 = Cast C-276 4 = Alloy 400 30 = Alloy C-276 252 = Unknown 253 = Special
119	4	FLANGE.TYPE.CFG	Process connection style	RW	LK	12 = Conventional (Traditional) 13 = Coplanar 14 = Remote Seal 15 = Level; 3-in., 150 lb 16 = Level; 4-in., 150 lb 17 = Level; 3-in., 300lb 18 = Level; 4-in., 300 lb 19 = Level; DN 80, PN 40 20 = Level; DN 100, PN 40 21 = Level; DN 100, PN 10/16 22 = Level; 2-in., 150 lb 23 = Level; 2-in., 300 lb 24 = Level; DN 50, PN 6 25 = Level; DN 50, PN 40 44 = 1/2-in., NPTF 45 = DIN16288G 1/2 A male 46 = 1/4-in., NPTF 240 = Auto Clave F-250-C 241 = Tri Clamp 242 = Fractional line fit 243 = 1/8-in., NPTF 244 = VCR 245 = PMC 246 = Traditional RC 1/4 247 = Traditional RC 1/2 252 = Unknown 253 = Special
119	5	DRAIN.VENT.CFG	Drain/vent valve material	RW	LK	0 = Carbon Steel 2 = 316 Stainless Steel 3 = Cast C-276 4 = Alloy 400 30 = Alloy C-276 251 = None 252 = Unknown 253 = Special
119	6	ORING.MATL.CFG	O-Ring material	RW	LK	10 = PTFE 11 = Viton 12 = Buna-N 13 = Ethyl propionate 36 = PTFE glass 37 = PTFE graphite 251 = None 252 = Unknown 253 = Special

**Table 4-14. Rosemount 4088B BSAP Signal Information**

List	Index	BSAP signal	Name	Access type	Control bits	Description
119	7	REMOTE.SEAL.CFG	Remote seal type	RW	LK	2 = CTW 3 = EFW 4 = PFW 5 = RFW 6 = RTW 7 = SCW 8 = SSW 9 = High temperature 10 = FFW 11 = UCW 12 = TSW 13 = NWSP 14 = SSAP 15 = SSHP 16 = TFS 251 = None 252 = Unknown 253 = Special
119	8	REMOTE.FILL.CFG	Remote seal fill fluid	RW	LK	2 = Silicone oil 3 = SYLTHERM 800 4 = Inert 5 = Glycerin H <sub>2</sub> O 6 = Prop glycol/H <sub>2</sub> O 7 = Neobee-M20 8 = SYLTHERM XLT 9 = Dioctyl phthalate 10 = D.C. Silicone 704 11 = Therminol 66 12 = D.C. Silicone 210H 13 = Distilled water 14 = D.C. Silicone 200 15 = D.C. Silicone 705 251 = None 252 = Unknown 253 = Special
119	9	REMOTE.ISO.CFG	Remote seal isolating diaphragm material	RW	LK	2 = 316 Stainless Steel 3 = Alloy C-276 4 = Alloy 400 5 = Tantalum 9 = Co-Cr-Ni 34 = PTFE-coated 316L SST 240 = Nickel 201 251 = None 252 = Unknown 253 = Special
119	10	NUMBER.SEAL.CFG	Number of remote seals	RW	LK	1 = One seal 2 = Two seals 250 = Not used 251 = None 252 = Unknown 253 = Special
120	1	SENSOR.BLOCK.NUM	Sensor module serial number	RO	MI	Sensor module serial number

**Table 4-14. Rosemount 4088B BSAP Signal Information**

List	Index	BSAP signal	Name	Access type	Control bits	Description
120	2	SENSOR.TYPE.CODE	Sensor module type	RO	MI	2 = Absolute pressure (AP) 6 = DP with AP high side static pressure 7 = DP with GP high side static pressure 12 = Gage pressure (GP) 32 = Differential pressure (DP) 253 = Custom
120	3	RTD.SENSOR.TYPE	Temperature sensor type	RW	MI	0 = 4-wire RTD sensor 1 = 3-wire RTD sensor
120	4	SENSOR.CONF.	Sensor module configuration	RO	MI	0 = Standard coplanar (C) 1 = Standard threaded (T) 2 = Level coplanar (L) 3 = Reference class coplanar (P) 4 = High temperature conventional (H) 252 = Unknown
120	5	XMT.TYPE.CFG	Device model	RO	MI	9832 = 0x2668 hex 1st byte is manufacture id (RMT = 26 hex) 2nd byte is device type (68 hex)
120	6	HARDWARE.REV.	Hardware revision	RO	MI	N/A
128	1	MASTER.RESET.	Master reset	RW	LK	OFF = No action ON = Perform reset Signal can be written to regardless of the state of the transmitter security switch.
129	1	RANGE.READ.DP	Differential pressure sensor range	RO	MI	1 = 1 2 = 2 3 = 3 4 = 4 5 = 5 10 = A (extended range) 253 = Special
129	2	RANGE.READ.SP	Static pressure sensor range	RO	MI	1 = 1 2 = 2 3 = 3 4 = 4 5 = 5 6 = 6 7 = 7 253 = Special
129	3	FACTORY.XMIT.CFG	Transmitter manufacturer	RO	MI	38 - Rosemount
129	4	HARDWARE.REV.	Hardware revision	RO	MI	N/A
130	1	DESCRIP.USER.CFG	Description	RW	LK	This field can hold numbers, symbols, and upper-case letters (16 characters)
130	2	MESSAGE.USER.CFG	Message	RW	LK	This field can hold numbers, symbols, and uppercase letters (32 characters)

**Table 4-14. Rosemount 4088B BSAP Signal Information**

List	Index	BSAP signal	Name	Access type	Control bits	Description
139	1	FB_FW1.PROD.VAL	Software revision	RO	None	N/A
140	1	SCROLL.LCDT.CFG	LCD Display scroll time	RW	LK	Value given in seconds
140	2	LCD_BIT.MASK.CFG	Display options	RW	LK	Each bit can enable/disable a specific LCD display: Bit 0 = Differential pressure Bit 1 = Absolute pressure Bit 2 = Process temperature Bit 3 = Baud rate Bit 4 = Gage pressure Bit 5 = Sensor module temperature Bit 7 = Device address Bit 8 = Parameter 1 Bit 9 = Parameter 2 Bit 10 = Parameter 3 Bit 11 = Parameter 4 Bit 12 = Parameter 5 Bit 13 = Parameter 6 Bit 16 = Variable 1 Bit 17 = Variable 2 Bit 18 = Variable 3
140	3	USERVAL.LABEL.1	User-Defined parameter 1 label	RW	LK	ISO-Latin-1 (10 characters)
140	4	USERVAL.PARAM.1	User-Defined parameter 1 value	RW	LK	User-defined
140	5	USERVAL.UOFM.1	User-Defined parameter 1 units	RW	LK	ISO-Latin-1 (5 characters)
140	6	USERVAL.LABEL.2	User-Defined parameter 2 label	RW	LK	ISO-Latin-1 (10 characters)
140	7	USERVAL.PARAM.2	User-Defined parameter 2 value	RW	LK	User-defined
140	8	USERVAL.UOFM.2	User-Defined parameter 2 units	RW	LK	ISO-Latin-1 (5 characters)
140	9	USERVAL.LABEL.3	User-Defined parameter 3 label	RW	LK	ISO-Latin-1 (10 characters)
140	10	USERVAL.PARAM.3	User-Defined parameter 3 value	RW	LK	User-defined
140	11	USERVAL.UOFM.3	User-Defined parameter 3 units	RW	LK	ISO-Latin-1 (5 characters)

**Table 4-14. Rosemount 4088B BSAP Signal Information**

List	Index	BSAP signal	Name	Access type	Control bits	Description
140	12	USERVAL.LABEL.4	User-Defined parameter 4 label	RW	LK	ISO-Latin-1 (10 characters)
140	13	USERVAL.PARAM.4	User-Defined parameter 4 value	RW	LK	User-defined
140	14	USERVAL.UOFM.4	User-Defined parameter 4 units	RW	LK	ISO-Latin-1 (5 characters)
140	15	USERVAL.LABEL.5	User-Defined parameter 5 label	RW	LK	ISO-Latin-1 (10 characters)
140	16	USERVAL.PARAM.5	User-Defined parameter 5 value	RW	LK	User-defined
140	17	USERVAL.UOFM.5	User-Defined parameter 5 units	RW	LK	ISO-Latin-1 (5 characters)
140	18	USERVAL.LABEL.6	User-Defined parameter 6 label	RW	LK	ISO-Latin-1 (10 characters)
140	19	USERVAL.PARAM.6	User-Defined parameter 6 value	RW	LK	User-defined
140	20	USERVAL.UOFM.6	User-Defined parameter 6 units	RW	LK	ISO-Latin-1 (5 characters)
140	21	USERVAL.VAR.1	User-Defined variable 1 value	RW	LK	Signal can be written to regardless of the state of the transmitter security switch
140	22	USERVAL.TEXT.1	User-Defined variable 1 label	RW	LK	ISO-Latin-1 (10 characters)
140	23	USERVAL.VAR.2	User-Defined variable 2 value	RW	LK	Signal can be written to regardless of the state of the transmitter security switch
140	24	USERVAL.TEXT.2	User-Defined variable 2 label	RW	LK	ISO-Latin-1 (10 characters)
140	25	USERVAL.VAR.3	User-Defined variable 3 value	RW	LK	Signal can be written to regardless of the state of the transmitter security switch.
140	26	USERVAL.TEXT.3	User-Defined variable 3 label	RW	LK	ISO-Latin-1 (10 characters)
140	27	USERVAL.UOFM.VAR 1	User-Defined variable 1 units	RW	MI	ISO-Latin-1 (5 characters)
140	28	USERVAL.UOFM.VAR 2	User-Defined variable 2 units	RW	MI	ISO-Latin-1 (5 characters)
140	29	USERVAL.UOFM.VAR 3	User-Defined variable 3 units	RW	MI	ISO-Latin-1 (5 characters)

**Table 4-14. Rosemount 4088B BSAP Signal Information**

List	Index	BSAP signal	Name	Access type	Control bits	Description
141	1	MODEL.NUM.1	Model number 1	RW	LK	This field can hold numbers, symbols, and uppercase letters (32 characters)
141	2	MODEL.NUM.2	Model number 2	RW	LK	
141	3	MODEL.NUM.3	Model number 3	RW	LK	
141	4	MODEL.NUM.4	Model number 4	RW	LK	
142	1	BOARD.SERIAL.NUM	Electronics board serial number	RO	MI	Electronics board serial number
152	1	STATIC.ZERO.CAL	Static pressure lower trim point	RW	None	User-entered pressure during the 2-point SP zero trim in static pressure units
152	2	STATIC.SPAN.CAL	Static pressure upper trim	RW	None	User-entered pressure during 2-point SP span trim in static pressure units
152	6	SP.CAL.ZERO	Legacy calibration static pressure lower trim point	RO	LK	User-entered zero value given in static pressure units
152	7	SP.CAL.SPAN	Legacy calibration static pressure upper trim point	RO	LK	User-entered span value given in static pressure units
153	1	TEMP.ZERO.CAL	Process temperature lower trim point	RW	LK	Value given in process temperature units
153	2	TEMP.SPAN.CAL	Process temperature upper trim point	RW	LK	Value given in process temperature units
153	6	USER.ZERO.CAL	Legacy calibration process temperature lower trim point	RO	LK	Value given in process temperature units
153	7	USER.SPAN.CAL	Legacy calibration process temperature upper trim point	RO	LK	Value given in process temperature units
160	1	DP.SIM.VAL	Simulate differential pressure	RW	LK	Value given in differential pressure units
160	2	DP.SIM.ENA	Enable differential pressure simulation	RW	LK	OFF = Simulation disabled ON = Simulation enabled
160	3	SP.SIM.VAL	Simulate static pressure	RW	LK	Value given in static pressure units
160	4	SP.SIM.ENA	Enable static pressure simulation	RW	LK	OFF = Simulation disabled ON = Simulation enabled

**Table 4-14. Rosemount 4088B BSAP Signal Information**

List	Index	BSAP signal	Name	Access type	Control bits	Description
160	5	PT.SIM.VAL	Simulate process temperature	RW	LK	Value given in process temperature units
160	6	PT.SIM.ENA	Enable process temperature simulation	RW	LK	OFF = Simulation Disabled ON = Simulation Enabled
160	7	ST.SIM.VAL	Simulate sensor module temperature	RW	LK	Value given in sensor module temperature units
160	8	ST.SIM.ENA	Enable sensor module temperature simulation	RW	LK	OFF = Simulation disabled ON = Simulation enabled
161	1	DP.USRVAL.PNT1	Differential pressure verification reference point 1	RW	LK	Value given in differential pressure units
161	2	DP.READ.PNT1	Differential pressure device reading 1	RO	MI	Value given in differential pressure units
161	3	DP.USRVAL.PNT2	Differential pressure verification reference point 2	RW	LK	Value given in differential pressure units
161	4	DP.READ.PNT2	Differential pressure device reading 2	RO	MI	Value given in differential pressure units
161	5	DP.USRVAL.PNT3	Differential pressure verification reference point 3	RW	LK	Value given in differential pressure units
161	6	DP.READ.PNT3	Differential pressure device reading 3	RO	MI	Value given in differential pressure units
161	7	DP.USRVAL.PNT4	Differential pressure verification reference point 4	RW	LK	Value given in differential pressure units
161	8	DP.READ.PNT4	Differential pressure device reading 4	RO	MI	Value given in differential pressure units
161	9	DP.USRVAL.PNT5	Differential pressure verification reference point 5	RW	LK	Value given in differential pressure units
161	10	DP.READ.PNT5	Differential pressure device reading 5	RO	MI	Value given in differential pressure units

**Table 4-14. Rosemount 4088B BSAP Signal Information**

List	Index	BSAP signal	Name	Access type	Control bits	Description
161	11	DP.USRVAL.PNT6	Differential pressure verification reference point 6	RW	LK	Value given in differential pressure units
161	12	DP.READ.PNT6	Differential pressure device reading 6	RO	MI	Value given in differential pressure units
162	1	SP.USRVAL.PNT1	Static pressure verification reference point 1	RW	LK	Value given in static pressure units
162	2	SP.READ.PNT1	Static pressure device reading 1	RO	MI	Value given in static pressure units
162	3	SP.USRVAL.PNT2	Static pressure verification reference point 2	RW	LK	Value given in static pressure units
162	4	SP.READ.PNT2	Static pressure device reading 2	RO	MI	Value given in static pressure units
162	5	SP.USRVAL.PNT3	Static pressure verification reference point 3	RW	LK	Value given in static pressure units
162	6	SP.READ.PNT3	Static pressure device reading 3	RO	MI	Value given in static pressure units
162	7	SP.USRVAL.PNT4	Static pressure verification reference point 4	RW	LK	Value given in static pressure units
162	8	SP.READ.PNT4	Static pressure device reading 4	RO	MI	Value given in static pressure units
162	9	SP.USRVAL.PNT5	Static pressure verification reference point 5	RW	LK	Value given in static pressure units
162	10	SP.READ.PNT5	Static pressure device reading 5	RO	MI	Value given in static pressure units
162	11	SP.USRVAL.PNT6	Static pressure verification reference point 6	RW	LK	Value given in static pressure units
162	12	SP.READ.PNT6	Static pressure device reading 6	RO	MI	Value given in static pressure units
163	1	PT.USRVAL.PNT1	Process temperature verification reference point 1	RW	LK	Value given in process temperature units
163	2	PT.READ.PNT1	Process temperature device reading 1	RO	MI	Value given in process temperature units



**Table 4-14. Rosemount 4088B BSAP Signal Information**

List	Index	BSAP signal	Name	Access type	Control bits	Description
163	3	PT.USRVAL.PNT2	Process temperature verification reference point 2	RW	LK	Value given in process temperature units
163	4	PT.READ.PNT2	Process temperature device reading 2	RO	MI	Value given in process temperature units
163	5	PT.USRVAL.PNT3	Process temperature verification reference point 3	RW	LK	Value given in process temperature units
163	6	PT.READ.PNT3	Process temperature device reading 3	RO	MI	Value given in process temperature units
163	7	PT.USRVAL.PNT4	Process temperature verification reference point 4	RW	LK	Value given in process temperature units
163	8	PT.READ.PNT4	Process temperature device reading 4	RO	MI	Value given in process temperature units
163	9	PT.USRVAL.PNT5	Process temperature verification reference point 5	RW	LK	Value given in process temperature units
163	10	PT.READ.PNT5	Process Temperature Device Reading 5	RO	MI	Value given in process temperature units
163	11	PT.USRVAL.PNT6	Process Temperature Verification Reference Point 6	RW	LK	Value given in process temperature units
163	12	PT.READ.PNT6	Process Temperature Device Reading 6	RO	MI	Value given in process temperature units
170	1	DP.STATUS.	Differential Pressure Variable Status	RO	MI	Status Format: Measurement quality - Limit status 0 = Bad - Not limited 16 = Bad - Low limited 32 = Bad - High limited 48 = Bad - Constant 64 = Poor Accuracy - Not limited 80 = Poor Accuracy - Low limited 96 = Poor Accuracy - High limited 112 = Poor Accuracy - Constant 128 = Manual/Fixed - Not limited 144 = Manual/Fixed - Low limited 160 = Manual/Fixed - High limited 176 = Manual/Fixed - Constant 192 = Good - Not limited 208 = Good - Low limited 224 = Good - High limited 240 = Good - Constant
170	2	SP.STATUS.	Static Pressure Variable Status	RO	MI	
170	3	PT.STATUS.	Process Temperature Variable Status	RO	MI	
170	4	ST.STATUS.	Sensor Module Temperature Variable Status	RO	MI	

Table 4-14. Rosemount 4088B BSAP Signal Information

List	Index	BSAP signal	Name	Access type	Control bits	Description
180	1	PROGREV..	N/A	N/A	MI	3808 legacy support
180	2	PRESSURE.SPAN.CAL	Pressure Upper Trim	RW	None	User-entered pressure during 2-point span trim in pressure units
180	3	STATIC.SPAN.CAL	Static Pressure Upper Trim	RW	None	User-entered pressure during 2-point SP span trim in static pressure units
180	4	PRESSURE.VAL.LRV	Pressure Lower Alert Limit	RW	LK	Value given in pressure units
180	5	PRESSURE.VAL.URV	Pressure Upper Alert Limit	RW	LK	Value given in pressure units
180	6	TEMP.VAL.LRV	Process Temperature Lower Alert Limit	RW	LK	Value given in process temperature units
180	7	TEMP.VAL.URV	Process Temperature Upper Alert Limit	RW	LK	Value given in process temperature units
180	8	PRESSURE.VAL.LRL	Pressure Lower Sensor Limit	RO	MI	Value given in pressure units
180	9	PRESSURE.VAL.URL	Pressure Upper Sensor Limit	RO	MI	Value given in pressure units
180	10	STATIC.VAL.LRL	Static Pressure Lower Sensor Limit (for Installed Sensor)	RO	MI	Value given in static pressure units
180	11	STATIC.VAL.URL	Static Pressure Upper Sensor Limit (for Installed Sensor)	RO	MI	Value given in static pressure units
180	12	STATIC.VAL.LRV	Static Pressure Lower Alert Limit	RW	LK	Value given in static pressure units
180	13	STATIC.VAL.URV	Static Pressure Upper Alert Limit	RW	LK	Value given in static pressure units
180	14	PRESSURE.TARGET.	Pressure Upper Trim Point	RW	LK	Value given in pressure units
180	15	STATIC.TARGET.	Static Pressure Upper Trim Point	RW	LK	Value given in static pressure units
180	16	SENSOR.BLOCK.NUM	Sensor Module Serial Number	RO	MI	Sensor module serial number
180	17	BOARD.SERIAL.NUM	Electronics Board Serial Number	RO	MI	Electronics board serial number
180	18	RTD.MIN.SPAN	Process Temperature Minimum Span	RO	MI	Value given in process temperature units
180	19	PT.VAL.URL	Process Temperature Upper Sensor Limit	RW	MI	Value given in process temperature units

**Table 4-14. Rosemount 4088B BSAP Signal Information**

List	Index	BSAP signal	Name	Access type	Control bits	Description
180	20	PT.VAL.LRL	Process Temperature Lower Sensor Limit	RW	MI	Value given in process temperature units
180	21	DP.MIN.SPAN	Differential Pressure Minimum Span	RO	MI	Value given in differential pressure units
180	22	DP.CUTOFF.LOW	Differential Pressure Low DP Cutoff	RW	LK	Value given in differential pressure units
180	23	SP.MIN.SPAN	Static Pressure Minimum Span	RO	LK	Value given in static pressure units
180	24	SENSOR.TYPE.CODE	Sensor Module Type	RO	MI	2 = Absolute pressure (AP) 6 = DP with AP high side static pressure 7 = DP with GP high side static pressure 12 = Gage pressure (GP) 32 = Differential pressure (DP) 253 = Custom
180	25	SENSOR.CONF.	Sensor Module Configuration	RO	MI	0 = Standard coplanar (C) 1 = Standard threaded (T) 2 = Level coplanar (L) 3 = Reference class coplanar (P) 4 = High temperature conventional (H) 252 = Unknown
180	26	ST.URL.	Sensor Module Temperature Upper Sensor Limit	RO	MI	Value given in sensor module temperature units
180	27	ST.LRL.	Sensor Module Temperature Lower Sensor Limit	RO	MI	Value given in sensor module temperature units
180	28	ST.URV.	Sensor Module Temperature Lower Alert Limit	RW	LK	Value given in sensor module temperature units
180	29	ST.LRV.	Sensor Module Temperature Upper Alert Limit	RW	LK	Value given in sensor module temperature units
180	30	STATUS.OPTNS.	Device Configuration	RO	MI	Sum of one or more of the following values: 1 = DP sensor installed 2 = AP pressure installed 4 = GP pressure installed 8 = PT sensor installed 16 = LCD display present 32 = 4088 mode B 64 = N/A 128 = N/A For example, 33 = DP sensor installed (1) plus 4088 mode B (32)

**Table 4-14. Rosemount 4088B BSAP Signal Information**

List	Index	BSAP signal	Name	Access type	Control bits	Description
180	31	SP.LSL.	Static Pressure Lower Sensor Limit (Offset by Atmospheric Pressure)	RO	MI	Value given in static pressure units
180	32	SP.USL.	Static Pressure Upper Sensor Limit (Offset by Atmospheric Pressure)	RO	MI	Value given in static pressure units
180	33	ST.MIN.SPAN	Sensor Module Temperature Minimum Span	RO	MI	Value given in sensor module temperature units
180	34	XMT.SER.NUM	Transmitter Serial Number	RW	LK	N/A

---

## Section 5 Operation and Maintenance

---

---

Calibration .....	page 105
Simulate device variables .....	page 112

---

### 5.1 Calibration

The following procedures outline the major steps for calibrating and configuring the Rosemount™ 4088 MultiVariable™ Transmitter. Refer to the individual screen explanations for more detailed information. It is possible to degrade the performance of the transmitter if a sensor trim is done improperly or with inaccurate calibration equipment. Use an input source that is at least three times more accurate than the transmitter and allow the input to stabilize for 10 seconds before entering any values.

---

#### Note

Coplanar transmitter configurations measuring gage pressure with optional process temperature (measurement type 5 and 7) will report the pressure as differential pressure. This will be reflected on the LCD display nameplate, digital interfaces, and other user interfaces.

---

Perform the following steps to access the appropriate screen:

1. Select the **Service Tools** menu.
2. Select **Maintenance** on the menu tree.

---

#### Note

Whenever the User Interface software is about to change the configuration in the transmitter, a warning message will be displayed. These warnings remind you to put any automatic control loops to manual before changing or modifying the Rosemount 4088 configuration, and to return the control loops to automatic when finished with the configuration procedure.

---

#### 5.1.1 Sensor trim overview

Trim the sensors using either sensor or zero trim functions. Trim functions vary in complexity and are application-dependent. Both trim functions alter the transmitter's interpretation of the input signal.

#### Zero trim

Zero trim is a single-point offset adjustment. It is useful for compensating for mounting position effects and is most effective when performed with the transmitter installed in its final mounting position. Since this correction maintains the slope of the characterization curve, it should not be used in place of a sensor trim over the full sensor range.

When performing a zero trim with a manifold, refer to “Rosemount 305, 306, and 304 Manifolds” on page 49.

---

**Note**

The transmitter must be within five percent or less of the maximum span of true zero (zero-based) in order to perform a zero trim function. The transmitter will not allow the user to perform a zero trim on an absolute static pressure sensor. To correct mounting position effects on the absolute static pressure sensor, perform a lower sensor trim. The lower sensor trim function provides an offset correction similar to the zero trim function, but it does not require zero-based input.

---

### Full sensor trim

Sensor trim is a two-point sensor calibration where two end-point pressures are applied, and all output is linearized between them. Always adjust the lower sensor trim value first to establish the correct offset. Adjustment of the upper sensor trim value provides a slope correction to the characterization curve based on the lower sensor trim value. The trim values allow the user to optimize performance over a specified measuring range at the calibration temperature.

### Restore factory calibration

The **Restore Factory Calibration** button will restore the transmitter to the original factory characterization. The Restore Factory Calibration button can be useful for recovering from an inadvertent zero trim or inaccurate pressure source.

When the restore factory calibration function is used, the transmitter's upper and lower trim values are set to the values configured at the factory. If custom trim values were specified when the transmitter was ordered, the device will recall those values. If custom trim values were not specified, the device will recall the default upper and lower sensor limits.

### Last calibration points

The current upper and lower calibration points can be seen under the Last Calibration Points heading under the appropriate variable tab.

## 5.1.2 Differential pressure sensor calibration

Use the *Differential Pressure Calibration* tab to complete a zero trim procedure or a full DP sensor trim, see Figure 5-1 on page 107.

<b>Field Communicator</b>	3, 4, 1, 8
---------------------------	------------

Figure 5-1. Differential Pressure Calibration Tab

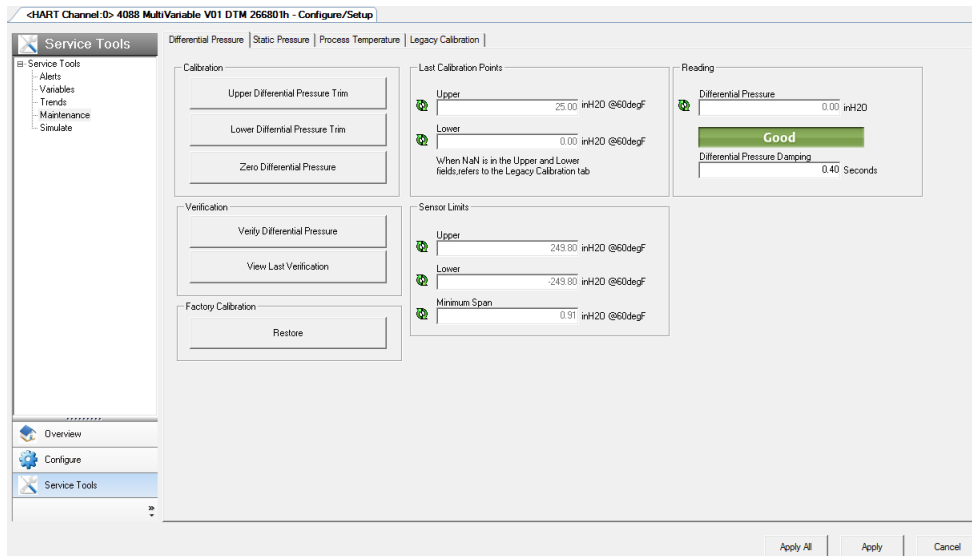

## Zero trim

To perform a DP sensor zero trim, go to *Service Tools > Maintenance*. Under the *Differential Pressure* tab, select the **Zero Differential Pressure** button and follow the on-screen prompts. The transmitter must be within five percent or less of the maximum span of true zero (zero-based) in order to calibrate with zero trim function.

### Note

When performing a DP sensor zero trim, ensure the equalizing valve is open and all wet legs are filled to the correct levels.

## Full sensor trim

A reference pressure device is required to perform a full sensor trim. Use a reference pressure device that is at least three times more accurate than the transmitter and allow the pressure input to stabilize for 10 seconds before entering any values.

To perform a DP full trim, first select the **Lower Differential Pressure Trim** button and follow the on-screen prompts. Next, select the **Upper Differential Pressure Trim** button and follow the on-screen prompts.

## Compensating for line pressure (range 4 and range 5)

The Rosemount 4088 Range 4 and 5 Pressure Transmitters require a special calibration procedure when used in differential pressure applications. The purpose of this procedure is to optimize transmitter performance by reducing the effect of static line pressure in these applications. The Rosemount 4088 Differential Pressure Transmitters (ranges 1, 2, 3, and A) do not require this procedure because optimization occurs in the sensor.

Applying high static pressure to the Rosemount 4088 Range 4 and Range 5 Pressure Transmitters causes a systematic shift in the output. This shift is linear with static pressure; correct it by performing the “**Full sensor trim**” on page 106.

The following specifications show the static pressure effect for the Rosemount 4088 Range 4 and Range 5 Transmitters used in differential pressure applications.

### Zero effect

± 0.1% of the upper sensor limit per 1000 psi (69 bar) for line pressures from 0 to 2000 psi (0 to 138 bar)

For line pressures above 2000 psi (138 bar), the zero effect error is ± 0.2% of the upper sensor limit plus an additional ± 0.2% of upper sensor limit error for each 1000 psi (69 bar) of line pressure above 2000 psi (138 bar).

Example: Line pressure is 3000 psi (207 bar). Zero effect error calculation:

± (0.2 + 0.2 x [3 – 2 kpsi]) = ± 0.4% of the upper sensor limit

### Span effect

Correctable to ±0.2% of reading per 1000 psi (69 bar) for line pressures from 0 to 3626 psi (0 to 250 bar)

The systematic span shift caused by the application of static line pressure is –0.85% of reading per 1000 psi (69 bar) for Range 4 transmitters, and –0.95% of reading per 1000 psi (69 bar) for range 5 transmitters.

Use the following example to compute corrected input values:

A transmitter with model number 4088xxxx4 will be used in a differential pressure application where the static line pressure is 1200 psi (83 bar).

To correct for systematic error caused by high static line pressure, use the following formulas to determine corrected values for the low trim and high trim.

$$LT = LTP + S \times (LTP) \times P$$

Where: LT = Corrected low trim value  
LTP = Lower trim point  
S = Span shift per specification  
P = Static line pressure

$$HT = UTP + S \times (UTP) \times P$$

Where: HT = Corrected high trim value  
UTP = Upper trim point  
S = Span shift per specification  
P = Static line pressure

In this example:

UTP = 1500 inH<sub>2</sub>O (3,74 bar)  
LTP = 500 inH<sub>2</sub>O (1,25 bar)  
P = 1200 psi (82,74 bar)  
S = 0.0085/1000

### Note

After performing a sensor trim on range 4 and 5 transmitters for high differential pressure applications, verify the upper and lower trim points are at the correct values. For the example above, this would be 500 inH<sub>2</sub>O and 1500 inH<sub>2</sub>O respectively. The zero effect can be eliminated by doing a zero sensor trim at line pressure after installation without affecting the completed calibration.



### 5.1.3 Static pressure sensor calibration

<b>Field Communicator</b>	3, 4, 2, 8
---------------------------	------------

The Static Pressure Calibration Tab allows the user to complete either a zero trim procedure or a full SP sensor trim, see [Figure 5-2](#).

**Figure 5-2. Static Pressure Calibration Tab**

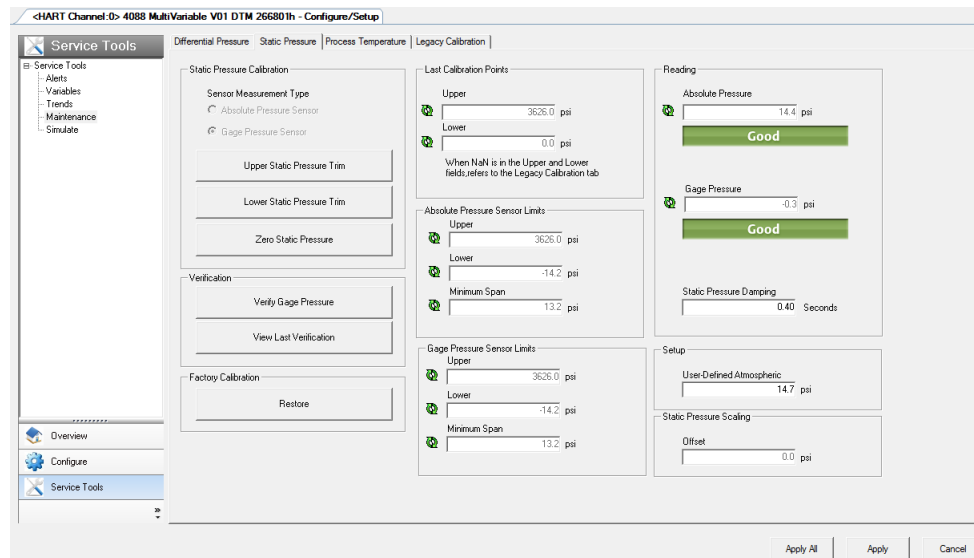

#### Zero trim or lower sensor trim

The type of static pressure sensor equipped in the transmitter can be determined by referring to the Static Pressure tab. This determines whether a zero trim (gage sensor) or lower sensor trim (absolute sensor) is required to correct for mounting position effects.

To perform a zero trim on a gage static pressure sensor, under the *Static Pressure Calibration* heading, select the **Zero Static Pressure** button and follow the on-screen prompts. The transmitter must be within five percent or less of the maximum span of true zero (zero-based) in order to calibrate with zero trim function.

To correct for mounting position effects on transmitters equipped with an absolute static pressure sensor, perform a lower sensor trim. This is accomplished by selecting the **Lower Static Pressure Trim** button and following the on-screen prompts. The lower sensor trim function provides an offset correction similar to the zero trim function, but it does not require a zero-based input.

#### Full sensor trim

To perform a static pressure full sensor trim, first select the **Lower Sensor Trim** button and follow the on-screen prompts. Next, select the **Upper Sensor Trim** button and follow the on-screen prompts.

### 5.1.4 Process temperature sensor calibration

<b>Field Communicator</b>	3, 4, 3, 8
---------------------------	------------

The Temperature Calibration tab allows the user to perform a sensor trim and configure the sensor matching of a process temperature sensor, see [Figure 5-3 on page 110](#).

Figure 5-3. Temperature Calibration Tab

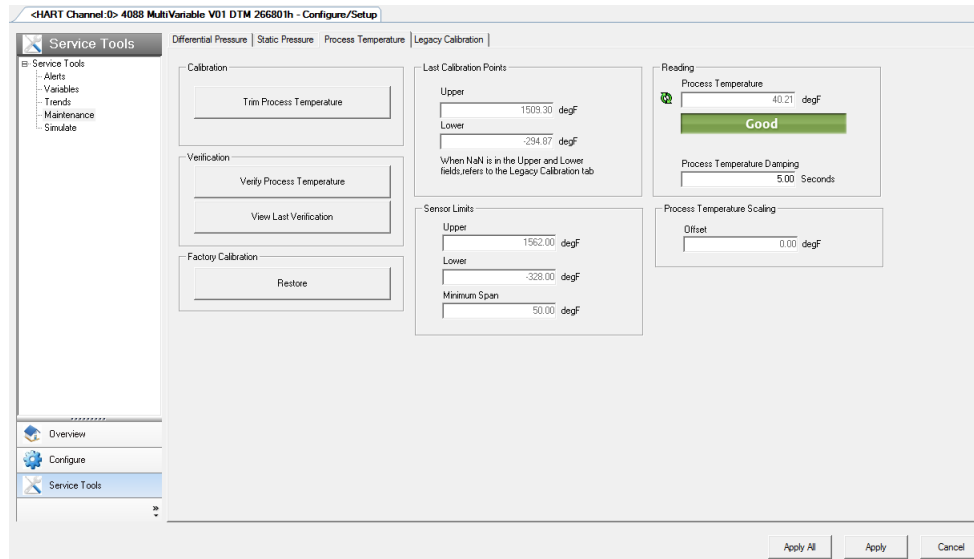

To calculate the corrected low trim (LT) value:

$$LT = 500 + (0.0085/1000)(500)(1200)$$

$$LT = 505.1 \text{ inH}_2\text{O (1,26 bar)}$$

To calculate the corrected high trim (HT) value:

$$HT = 1500 + (0.0085/1000)(1500)(1200)$$

$$HT = 1515.3 \text{ inH}_2\text{O (3,78 bar)}$$

Complete a sensor trim and enter the corrected values for low trim (LT) and high trim (HT), refer to “[Full sensor trim](#)” on page 106.

Enter the corrected input values for low trim and high trim through the Field Communicator keypad after you apply the value of pressure as the transmitter input.

## Process temperature full sensor trim

To calibrate the process temperature input using the sensor trim, follow the procedure below:

1. Set up a Temperature Calibrator to simulate a Pt 100 (100-ohm platinum, alpha 385 RTD). Connect the calibrator to the Rosemount 4088 terminal block. See [Figure 3-13 on page 48](#) for more information.
2. Under the *Process Temperature* tab, select the **Trim Process Temperature** button and follow the on-screen prompts.

To configure the calibrated Callendar-Van Dusen constants, see “[Process temperature](#)” on page 17.

### 5.1.5 Offset

An offset can be implemented for each of the process variables by going to the Legacy Calibration tab. This feature can be used for applications (e.g. differential pressure) to negate pressures that are more than five percent of the maximum span of the transmitter.

## 5.1.6 Verification

This process involves applying actual process conditions at a variety of points to verify the device’s calibration and store verification results. After creating these verification results, they may be viewed later by selecting **View Last Verification**. This allows the user to verify up to six points for each process variable and also generate reports in a spreadsheet format.

**Note**

This feature stores information, but does not affect trim or calibrations. If a Trim is performed, these results will not be cleared.

Perform the following steps to access the appropriate screen:

1. Select the **Service Tools** menu.
2. Select **Maintenance** on the menu tree.
3. Select the tab corresponding to the parameter to be verified.
4. Under the *Verification* heading, select the button corresponding to the parameter to be verified and follow the on-screen prompts.

<b>Field Communicator</b>	DP: 3, 4, 1, 9
	SP: 3, 4, 2, 9
	PT: 3, 4, 3, 9

**Note**

Once a verification point is written, it can never be deleted; it can only be rewritten.

**Figure 5-4. Process Variable Verification Method**

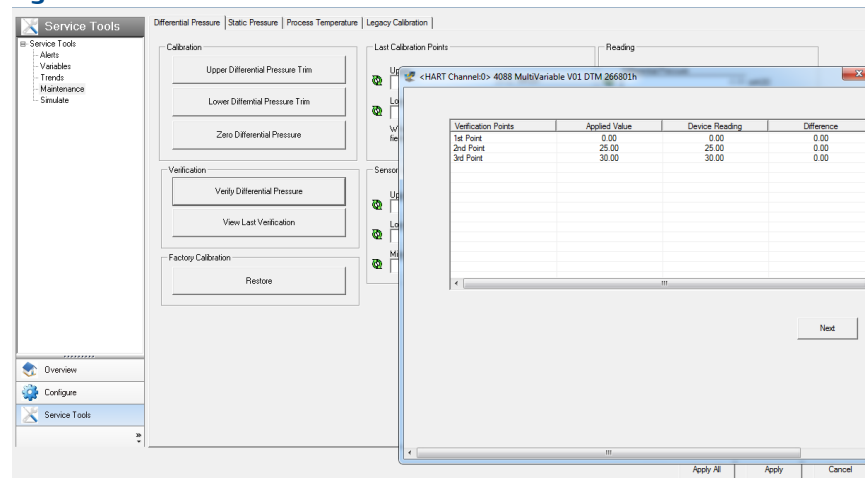

## 5.1.7 Legacy calibration

For best performance, the Rosemount 4088 should be calibrated using the upper and lower trim only. The Legacy Calibration Method uses midpoints between the upper and lower trim point to calibrate the pressure or temperature measurement. This has the potential to create non-linearity in the sensor module.

## 5.2 Simulate device variables

It is possible to temporarily set the differential pressure, static pressure (gage or absolute), process temperature, or sensor module temperature to a user-defined fixed value for testing purposes. After exiting the simulated variable method, the process variable will be automatically returned to a live measurement. Also, if power is cycled or a master reset is performed, the transmitter will revert back to a live measurement.

Perform the following steps to access the appropriate screen:

1. Select the **Service Tools** menu.
2. Select **Simulate** on the menu tree.

<b>Field Communicator</b>	3, 5
---------------------------	------

**Figure 5-5. Simulate Digital Signal with RTIS**

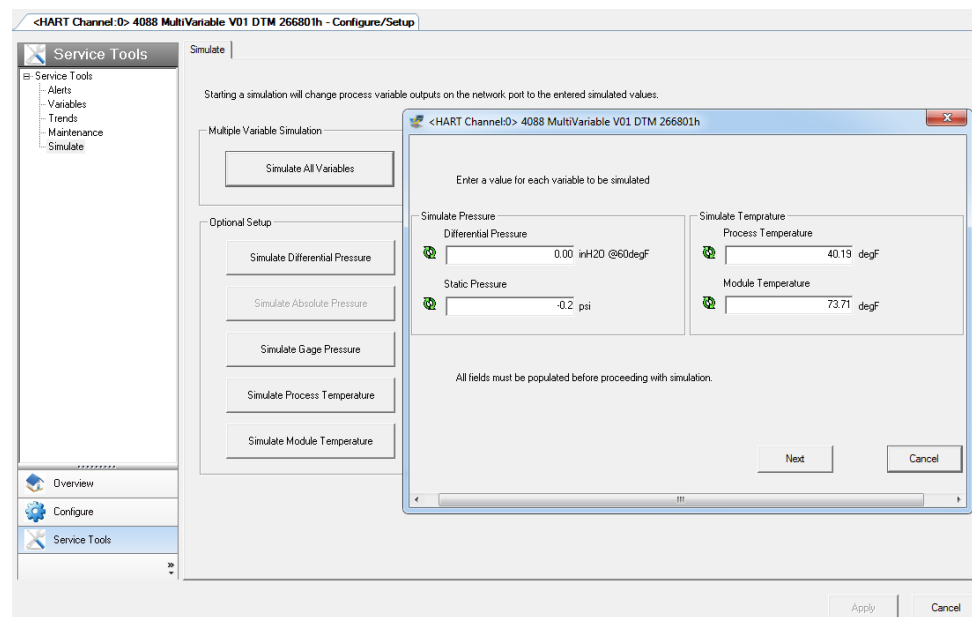

**Note**  
⚠ If the window is closed using the **X** button, simulation will remain on. Select either **Next** or **Cancel** to return to the live measurement.

---

# Section 6 Troubleshooting

---

---

Overview .....	page 113
Safety messages .....	page 113
Communications troubleshooting .....	page 114
Alarms and conditions .....	page 115
Field upgrades and replacements .....	page 117
Service support .....	page 122

---

## 6.1 Overview

This chapter provides summarized troubleshooting suggestions for the most common operating problems.

If you suspect a malfunction despite the absence of any diagnostic messages on the communicator display, follow the procedures described here to verify transmitter hardware and process connections are in good working order. Always deal with the most likely and easiest-to-check conditions first.

## 6.2 Safety messages

Procedures and instructions in this section may require special precautions to ensure the safety of the personnel performing the operations. Information that raises potential safety issues is indicated by a warning symbol (⚠). Refer to the following safety messages before performing an operation preceded by this symbol.

### ⚠ WARNING

**Explosions could result in death or serious injury.**

- Do not remove the transmitter cover in explosive atmospheres when the circuit is live.
- Both transmitter covers must be fully engaged to meet explosion-proof requirements.

---

### ⚠ CAUTION

**Static electricity can damage sensitive components.**

Observe safe handling precautions for static-sensitive components.

---

## 6.3 Communications troubleshooting

The table below identifies the most likely causes for communication problems with the Rosemount™ 4088 MultiVariable™ Transmitter.

Symptom	Corrective actions
No communication between Rosemount Transmitter Interface Software and the transmitter	<ul style="list-style-type: none"> <li>■ Check for proper voltage across the power terminals of the transmitter (5.4–30 Vdc).</li> <li>■ Verify there is no loop resistor in line with the HART® terminals.</li> <li>■ Verify the HART modem is plugged into the correct COM port, as configured within RTIS.</li> </ul>
No communication between the transmitter and the host	<ul style="list-style-type: none"> <li>■ Check for proper voltage across the power terminals of the transmitter (5.4–30 Vdc).</li> <li>■ Verify the RS-485 bus is terminated with 120 Ohm resistors or via AC termination, at each end of the bus.</li> <li>■ Verify the RS-485 bus is NOT terminated at points other than at each end of the bus.</li> <li>■ Check for intermittent shorts, open circuits, and multiple grounds.</li> <li>■ Verify the power wiring and RS-485 bus wiring are not switched.</li> <li>■ Verify the RS-485 wires are connected to the correct A and B communication terminals.</li> <li>■ Verify identical baud rates for the host and transmitter.</li> <li>■ Verify the transmitter address.</li> <li>■ The turnaround delay time for the transmitter may be too fast for host.</li> <li>■ Try using a longer time (see “Communications” on page 62).</li> <li>■ The RTU may be polling too fast and cutting off the transmitter response messages. Try adjusting the polling time on the RTU.</li> <li>■ Verify the software for the host is functioning properly.</li> </ul>
Transmitter is not responding with meaningful data	<ul style="list-style-type: none"> <li>■ The host may have register addresses referenced to 0 rather than 1. Try subtracting or adding 1 from register addresses when polling.</li> <li>■ Verify the Rosemount 4088 is transmitting floating point data in the correct format for the host (see “Floating point formats” on page 61).</li> </ul>

## 6.4 Alarms and conditions

Table 6-1. Failed - Fix Now

Alert name	LCD display screen	Problem description	Recommended action	Rosemount 4088A Modbus 16-bit floating point register	BSAP Signal UNIT.STATUS.
Sensor module failure	FAIL SENSOR ERROR	Failure has been detected in the sensor module	1. Replace the sensor module.	408 bit 1	Bits 0, 1, and 2
Sensor module incompatibility	SNSR INCOMP ERROR	Sensor module is not compatible with the electronic circuit board	1. Replace the sensor module.	409 bit 11	Bits 0, 1, and 2
Electronic circuit board error	FAIL BOARD ERROR	Failure has been detected in the electronic circuit board	1. Replace the electronic circuit board.	409 bit 5	Bits 0,1, 2, and 3
Sensor module communication error	SNSR COMM ERROR	Electronic circuit board has stopped receiving updates from the sensor module	1. Check the cable and cable connection between the sensor module and electronic circuit board. 2. Replace the electronic circuit board. 3. Replace the sensor module.	409 bit 15	Bits 0, 1, and 2
Process temperature sensor failure	PT FAIL ERROR	Process temperature measurement has failed	1. Ensure all sensor wires are properly connected. 2. Ensure the temperature sensor type is properly configured. 3. Replace the temperature sensor. 4. Replace the electronic circuit board.	408 bit 8	Bit 3

Table 6-2. Maintenance - Fix Soon

Alert name	LCD display screen	Problem description	Recommended action	Rosemount 4088A Modbus 16-bit floating point register	BSAP Signal UNIT.STATUS.
LCD update failure	[None]	Electronic circuit board has lost communication with the LCD display	1. Check the connection between the LCD display and electronic circuit board. 2. Replace the LCD display. 3. Replace the electronic circuit board.	408 bit 2	N/A
Power failure	FAIL POWER ERROR	Transmitter has detected a terminal voltage that is too low	1. Check the DC power supply to make sure the power is correct and stable. 2. Replace the electronic circuit board.	409 bit 14	Bits 0, 1, and 2
RTD sensor type mismatch	PT CONFIG ERROR	Transmitter has detected that the sensor type does not match what is configured	1. Ensure all sensor wires are properly connected. 2. Ensure the temperature Sensor Type is properly configured. 3. Replace the electronic circuit board.	408 bit 3	Bit 3

**Table 6-2. Maintenance - Fix Soon**

Alert name	LCD display screen	Problem description	Recommended action	Rosemount 4088A Modbus 16-bit floating point register	BSAP Signal UNIT.STATUS.
Differential pressure out of limits	DP LIMIT	Differential pressure is either above or below the sensor limits	<ol style="list-style-type: none"> <li>1. Check the transmitter pressure connection to make sure it is not plugged or isolating diaphragms are not damaged.</li> <li>2. Replace the pressure sensor module.</li> </ol>	407 bit 12 or 7	Bit 4
Static pressure out of limits	AP GP LIMIT	Static pressure is either above or below the sensor limits	<ol style="list-style-type: none"> <li>1. Check the transmitter pressure connection to make sure it is not plugged and/or the isolating diaphragms are not damaged.</li> <li>2. Replace the pressure sensor module.</li> </ol>	407 bit 6 or 1	Bit 5
Process temperature out of limits	PT LIMIT	Process temperature is either above or below the sensor limits	<ol style="list-style-type: none"> <li>1. Check the process temperature for conditions outside of sensor limits.</li> <li>2. Replace the temperature sensor.</li> </ol>	408 bit 13 or 10	Bit 7
Module temperature out of limits	SNSRT LIMIT	Module temperature is either above or below the sensor limits	<ol style="list-style-type: none"> <li>1. Check the process and ambient temperatures to ensure they are within specifications.</li> <li>2. Replace the sensor module.</li> </ol>	408 bit 7 or 6	Bit 6

**Table 6-3. Advisory**

Alert name	LCD display screen	Problem description	Recommended action	Rosemount 4088A Modbus 16-bit floating point register	BSAP Signal UNIT.STATUS.
Differential pressure alert	DP ALERT	Differential pressure alert diagnostic has detected that the pressure has gone beyond the configured alert limits	<ol style="list-style-type: none"> <li>1. Verify the differential pressure is beyond the alert limits.</li> <li>2. Modify the alert limits.</li> </ol>	407 bit 10 or 9	Bit 12
Static pressure alert	AP GP ALERT	Static pressure alert diagnostic has detected that the pressure has gone beyond the configured alert limits	<ol style="list-style-type: none"> <li>1. Verify the static pressure is beyond the alert limits.</li> <li>2. Modify the alert limits.</li> </ol>	407 bit 4 or 3	Bit 13
Process temperature alert	PT ALERT	Process temperature alert diagnostic has detected that the temperature has gone beyond the configured alert limits	<ol style="list-style-type: none"> <li>1. Verify the process temperature is beyond the alert limits.</li> <li>2. Modify the alert limits.</li> </ol>	408 bit 12 or 11	Bit 15



Table 6-3. Advisory

Alert name	LCD display screen	Problem description	Recommended action	Rosemount 4088A Modbus 16-bit floating point register	BSAP Signal UNIT.STATUS.
Module temperature alert	SNSRT ALERT	Module temperature alert diagnostic has detected that the temperature has gone beyond the configured alert limits	<ol style="list-style-type: none"> <li>1. Verify the module temperature is beyond the alert limits.</li> <li>2. Modify the alert limits.</li> </ol>	408 bit 5 or 4	Bit 14
Simulation active	[None]	Device is in simulation mode and may not be reporting actual information	<ol style="list-style-type: none"> <li>1. Verify that simulation is no longer required.</li> <li>2. Disable simulation mode in Service Tools.</li> <li>3. Perform a Device Reset.</li> </ol>	409 bit 0, 3, 7, or 8	Bits 8, 9, 10, or 11

## 6.5 Field upgrades and replacements

### 6.5.1 Disassembly considerations

-  During disassembly, do not remove the instrument cover in explosive atmospheres when the circuit is live as this may result in serious injury or death. Also, be aware of the following:
- Follow all plant safety rules and procedures.
  - Isolate and vent the process from the transmitter before removing the transmitter from service.
  - Disconnect optional process temperature sensor leads and cable.
  - Remove all other electrical leads and conduit.
  - Detach the process flange by removing the four flange bolts and two alignment screws that secure it.
  - Do not scratch, puncture, or depress the isolating diaphragms.
  - Clean isolating diaphragms with a soft rag and a mild cleaning solution, then rinse with clear water.
  - Whenever the process flange or flange adapters are removed, visually inspect the PTFE O-rings. Emerson™ recommends reusing O-rings if possible. If the O-rings show any signs of damage, such as nicks or cuts, they should be replaced.

### 6.5.2 Housing assembly including electronics board

#### Field device labels

The sensor module label reflects the replacement model code for reordering a complete transmitter.

#### Replacing the housing assembly including electronics board

##### Remove the electronics board

The Rosemount 4088 electronics board is located opposite the field terminal side in the housing. To remove the electronics board, perform the following procedure:

1. Remove the housing cover opposite the field terminal side.

2. Remove the LCD display, if applicable. To do this, hold in the two clips and pull outward. This will provide better access to the two screws located on the electronics board.
3. Loosen the two captive screws located on the electronics board.
4. Pull out the electronics board to expose and locate the sensor module connector, see [Figure 6-1 on page 118](#).
5. Press the locking tabs and pull the sensor module connector upwards (avoid pulling wires). Housing rotation may be required to access locking tabs. See [“Consider housing rotation” on page 42](#) for more information.

**Figure 6-1. Sensor Module Connector View**

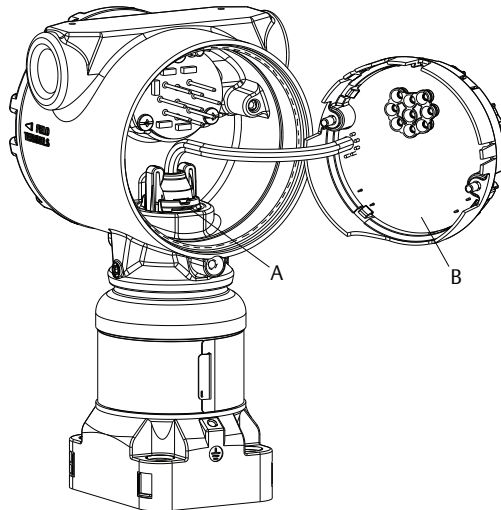

- A. Sensor module connector
- B. Electronics board

### Separate the sensor module assembly from the housing

1. To prevent damage to the sensor module connector, remove the electronics board from the sensor module assembly and remove the connector before separating the sensor module assembly from the housing.
2. Loosen the housing rotation set screw by one full turn with a  $\frac{3}{32}$ -in. hex wrench (see [Figure 6-2](#)).
3. Unscrew the housing from the sensor module threads.

**Figure 6-2. Set Screw**

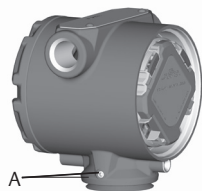

- A. Housing rotation set screw ( $\frac{3}{32}$ -in.)

### Attach the sensor module assembly to the housing

1. Apply a light coat of low temperature silicon grease to the sensor module threads and O-ring.
- ⚠ 2. Thread the housing completely onto the sensor module assembly. The housing must be no more than one full turn from flush with the sensor module assembly to comply with flame-proof/explosion-proof requirements.
3. Tighten the housing rotation set screw using a  $\frac{3}{32}$ -in. hex wrench to a recommended torque of 30 in-lb (3.4 N-m).

#### Note

The V-seal (03151-9061-0001) must be installed at the bottom of the housing (see [Figure 6-3](#)).

Figure 6-3. V-Seal

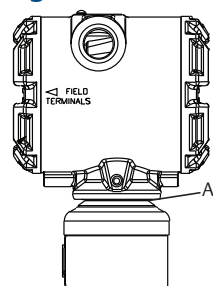

A. Black rubber V-seal

### Install electronics board in the housing

1. Apply a light coat of low temperature silicon grease to the sensor module connector O-ring.
2. Insert the sensor module connector into the top of the sensor module assembly. Ensure the locking tabs are fully engaged.
3. Gently slide the electronics board into the housing, making sure the pins from the housing properly engage the receptacles on the electronics board.
4. Tighten the captive screws.
- ⚠ 5. Attach the housing cover and tighten so that metal contacts metal to meet flame-proof/explosion-proof requirements.

## 6.5.3 Terminal block

Electrical connections are located on the terminal block in the compartment labeled “FIELD TERMINALS.” The terminal block may be replaced or upgraded to add transient protection. Part numbers can be found in “[Spare parts list](#)” on page 123.

Loosen the two captive screws (see [Figure 6-4 on page 120](#)) and pull the entire terminal block out.

**Figure 6-4. Terminal Blocks**

**Without optional process temperature connections**

**With optional process temperature connections**

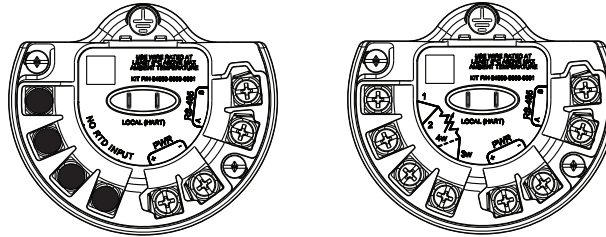

1. Gently slide the terminal block into the housing, making sure the pins from the Rosemount 4088 housing properly engage the receptacles on the terminal block.
2. Tighten the captive screws on the terminal block.
- ⚠ 3. Attach the Rosemount 4088 housing cover and tighten so metal contacts metal to meet flame-proof/explosion-proof requirements.

## 6.5.4 LCD display

Transmitters ordered with the LCD display will be shipped with the display installed. Installing the display on an existing Rosemount 4088 requires the LCD display kit (part number 00753-9004-0001 for aluminum housing and 00753-9004-0004 for stainless steel housing).

Use the following procedure and [Figure 6-5](#) to install the LCD display:

1. If the transmitter is installed in a loop, then secure the loop and disconnect power.
- ⚠ 2. Remove the transmitter cover on the electronics board side (opposite the field terminals side). Do not remove instrument covers in explosive environments when circuit is live.
3. Engage the 4-pin connector into the electronics board and snap LCD display into place.
- ⚠ 4. In order to meet explosion-proof requirements, reinstall the housing cover and tighten so the cover is fully seated with metal to metal contact between the housing and cover.

**Figure 6-5. Optional LCD Display**

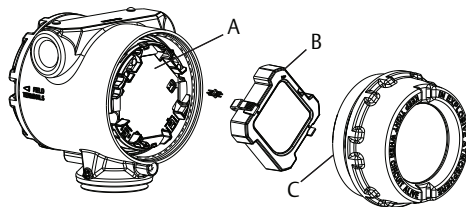

- A. Electronics board
- B. LCD display
- C. Display cover

## 6.5.5 Flange and drain vent

The Rosemount 4088 is attached to the process connection flange by four bolts and two alignment cap screws.

1. Remove the two alignment cap screws.

**Figure 6-6. Alignment Cap Screws**

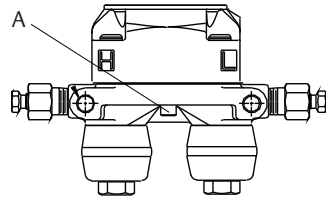

A. Alignment cap screw

2. Remove the four bolts and separate the transmitter from the process connection, but leave the process connection flange in place and ready for re-installation.

**Note**

If the installation uses a manifold, see “Manifold operation” on page 52.

3. Inspect the sensor module PTFE O-rings. If the O-rings are undamaged, they may be reused. Emerson recommends reusing O-rings if possible. If the O-rings show any signs of damage, such as nicks or cuts, they should be replaced (part number 03151-9042-0001 for glass-filled PTFE and part number 03151-9042-0002 for graphite-filled PTFE).

**Note**

If replacing the O-rings, be careful not to scratch or deface the O-ring grooves or the surface of the isolating diaphragm when removing the damaged O-rings.

4. Install the process flange on the sensor module process connection. To hold the process flange in place, install the two alignment cap screws finger tight (these screws are not pressure retaining). Do not overtighten; this will affect module-to-flange alignment.
5. Install the appropriate flange bolts.
  - a. If the installation requires a 1/4–18 NPT connection(s), use four 1.75-in. flange bolts. Finger tighten the bolts. Go to [Step d](#).
  - b. If the installation requires a 1/2–14 NPT connection(s), use flange adapters and four 2.88-in. process flange/adaptor bolts.
  - c. Hold the flange adapters and adapter O-rings in place while finger-tightening the bolts.
  - d. Tighten the bolts to the initial torque value using a crossed pattern. See [Table 6-4 on page 122](#) for appropriate torque values.
  - e. Tighten the bolts to the final torque value using a crossed pattern. See [Table 6-4](#) for appropriate torque values. When fully tightened, the bolts should extend through the top of the module housing.
  - f. Torque alignment screws to 30 in-lb (3.4 N-m). If the installation uses a conventional manifold, then install flange adapters on the process end of the manifold using the 1.75-in. flange bolts supplied with the transmitter.

**Table 6-4. Bolt Installation Torque Values**

Bolt material	Initial torque value	Final torque value
CS-ASTM-A449 Standard	300 in-lb (34 N-m)	650 in-lb (73 N-m)
316 SST—Option L4	150 in-lb (17 N-m)	300 in-lb (34 N-m)
ASTM-A-193-B7M—Option L5	300 in-lb (34 N-m)	650 in-lb (73 N-m)
Alloy K-500—Option L6	300 in-lb (34 N-m)	650 in-lb (73 N-m)
ASTM-A-453-660—Option L7	150 in-lb (17 N-m)	300 in-lb (34 N-m)
ASTM-A-193-B8M—Option L8	150 in-lb (17 N-m)	300 in-lb (34 N-m)

6. If the sensor module PTFE O-rings are replaced, re-torque the flange bolts and alignment cap screws after installation to compensate for seating of the PTFE O-ring.
7. Install the drain/vent valve.
  - a. Apply sealing tape to the threads on the seat. Starting at the base of the valve with the threaded end pointing toward the installer, apply two clockwise turns of sealing tape.
  - b. Take care to place the opening on the valve so that process fluid will drain toward the ground and away from human contact when the valve is opened.
  - c. Tighten the drain/vent valve to 250 in-lb (28.25 N-m).
  - d. Tighten the stem to 70 in-lb (8 N-m).

**Note**

Due to the range 1 DP Sensor's high accuracy at low pressures, extra steps are required to optimize performance. It is necessary to temperature soak the assembly using the following procedure.

1. After replacing O-rings on DP range 1 transmitters and re-installing the process flange, expose the transmitter to a temperature of 185 °F (85 °C) for two hours.
2. Re-tighten the flange bolts in a cross pattern.
3. Again, expose the transmitter to a temperature of 185 °F (85 °C) for two hours before calibration.

## 6.6 Service support

To expedite the return process outside of the United States, contact the nearest Emerson representative.

Within the United States, call the Emerson Instrument and Valves Response Center using the 1-800-654-RSMT (7768) toll-free number. This center, available 24 hours a day, will assist you with any needed information or materials.

The center will ask for product model and serial numbers, and will provide a Return Material Authorization (RMA) number. The center will also ask for the process material to which the product was last exposed.

**⚠ CAUTION**

Individuals who handle products exposed to a hazardous substance can avoid injury if they are informed of and understand the hazard. If the product being returned was exposed to a hazardous substance as defined by OSHA, a copy of the required Material Safety Data Sheet (MSDS) for each hazardous substance identified must be included with the returned goods.

Emerson Instrument and Valves Response Center representatives will explain the additional information and procedures necessary to return goods exposed to hazardous substances.

# Appendix A Reference Data

---

Product Certifications and Installation Drawings .....	page 123
Spare parts list .....	page 123
Ordering Information, Specifications, and Dimensional Drawings .....	page 123

---

## A.1 Product Certifications and Installation Drawings

To view current Rosemount 4088 Product Certifications and Installation Drawings, follow these steps:

1. Go to [Emerson.com/Rosemount/4088](http://Emerson.com/Rosemount/4088).
2. Scroll as needed to the green menu bar and click **Documents & Drawings**.
3. Click **Certificates & Approvals**.

## A.2 Ordering Information, Specifications, and Dimensional Drawings

To view current Rosemount 4088 Ordering Information, Specifications, and Dimensional Drawings, follow these steps:

1. Go to [Emerson.com/Rosemount/4088](http://Emerson.com/Rosemount/4088).
2. Scroll as needed to the green menu bar and click **Documents & Drawings**.
3. Click **Data Sheets & Bulletins**.
4. Select the appropriate Product Data Sheet.

## A.3 Spare parts list

Electronics board assembly hardware parts description	Part number
Rosemount 4088A - Modbus Protocol transmitter register mapping - temperature input enabled	04088-9030-0001
Rosemount 4088A - Modbus Protocol transmitter register mapping - temperature input disabled	04088-9030-0011
Rosemount 4088B - Remote Automation Systems ready transmitter register mapping - temperature input enabled	04088-9030-0002
Rosemount 4088B - Remote Automation Systems ready transmitter register mapping - temperature input disabled	04088-9030-0012
<b>LCD display</b>	
<b>Aluminum housing</b>	
LCD display kit: LCD display assembly, 4-pin interconnection header and aluminum cover assembly	00753-9004-0001
LCD display only: LCD display assembly, 4-pin interconnection header	00753-9004-0002
Cover assembly kit: aluminum cover assembly	03151-9193-0003
<b>SST housing</b>	
LCD display kit: LCD assembly, 4-pin interconnection header, stainless steel (SST) cover assembly	00753-9004-0004
LCD display kit: LCD assembly, 4-pin interconnection header	00753-9004-0002
Cover assembly kit: SST cover assembly	03151-9193-0005

<b>Terminal blocks</b>	
Standard terminal block assembly with temperature input	04088-9006-0001
Standard terminal block assembly without temperature input	04088-9006-0011
Transient protection terminal block assembly with temperature input	04088-9006-0002
Transient protection terminal block assembly without temperature input	04088-9006-0012
<b>Housings</b>	
<b>Aluminum housing</b>	
1/2-14 NPT conduit entry	04088-9059-1119
M20 conduit entry	04088-9059-1219
<b>SST housing</b>	
1/2-14 NPT conduit entry	04088-9059-0119
M20 conduit entry	04088-9059-0219
<b>Covers</b>	
Aluminum electronics cover; cover and O-ring	03151-9030-0001
SST electronics cover; cover and O-ring	03151-9030-0002
Extended aluminum electronics cover; cover and O-ring	03151-9030-0101
Extended SST electronics cover; cover and O-ring	03151-9030-0102
<b>Housing miscellaneous</b>	
External ground screw assembly (option D4): screw, clamp, washer	03151-9060-0001
Housing V-seal	03151-9061-0001
Housing header cable O-ring (package of 12)	03151-9011-0001
1/2 NPT SST conduit plug	03031-0544-0003
M20 SST conduit plug	03031-0544-0001
<b>Flanges</b>	
<b>Differential coplanar flange</b>	
Nickel-plated carbon steel (CS)	03151-9200-0025
SST	03151-9200-0022
Cast C-276	03151-9200-0023
<b>Gage/Absolute coplanar flange</b>	
Nickel-plated CS	03151-9200-1025
SST	03151-9200-1022
Cast C-276	03151-9200-1023
Coplanar flange alignment screw (package of 12)	03151-9202-0001
<b>Traditional flange</b>	
SST	03151-9203-0002
Cast C-276	03151-9203-0003



<b>Flange adapter kits (each kit contains adapters, bolts, and O-ring for one DP transmitter or two GP/AP transmitters)</b>	
<b>CS bolts, glass-filled PTFE O-rings</b>	
SST adapters	03031-1300-0002
Cast C-276 adapters	03031-1300-0003
Ni-plated CS adapters	03031-1300-0005
<b>SST bolts, glass-filled PTFE O-rings</b>	
SST adapters	03031-1300-0012
Cast C-276 adapters	03031-1300-0013
Ni-plated CS adapters	03031-1300-0015
<b>CS bolts, graphite PTFE O-rings</b>	
SST adapters	03031-1300-0102
Cast C-276 adapters	03031-1300-0103
Ni-plated CS adapters	03031-1300-0105
<b>SST bolts, graphite PTFE O-rings</b>	
SST adapters	03031-1300-0112
Cast C-276 adapters	03031-1300-0113
Ni-plated CS adapters	03031-1300-0115
<b>Flange adapter union</b>	
Nickel-plated CS	03151-9259-0005
SST	03151-9259-0002
Cast C-276	03151-9259-0003
<b>Drain/vent kits (each kit contains parts for one transmitter)</b>	
<b>Differential drain/vent kits</b>	
SST valve stem and seat kit	03151-9268-0022
Alloy C-276 valve stem and seat kit	03151-9268-0023
<b>Gage/absolute drain/vent kits</b>	
SST valve stem and seat kit	03151-9268-0012
Alloy C-276 valve stem and seat kit	03151-9268-0013
<b>O-ring packages (package of 12)</b>	
Electronic housing, cover (standard and LCD display)	03151-9040-0001
Electronic housing, module	03151-9041-0001
Process flange, glass-filled PTFE	03151-9042-0001
Process flange, graphite-filled PTFE	03151-9042-0002
Process adapter, glass-filled PTFE	03151-9043-0001
Process adapter, graphite-filled PTFE	03151-9043-0002

<b>Gland and collar kits</b>	
<b>Gland and collar kits</b>	03151-9250-0001
316 SST (set of six)	03151-9283-1002
ANSI/ASTM-A-193-B7M (set of six)	03151-9283-1003
Alloy K-500 (set of six)	03151-9283-1004
<b>Manifold/traditional flange bolts</b>	
CS	Use bolts supplied with manifold
316 SST	Use bolts supplied with manifold
<b>Mounting brackets</b>	
<b>Coplanar flange bracket kit</b>	
B4 bracket, SST, 2-in. pipe mount, SST bolts	03151-9270-0001
<b>Traditional flange bracket kit</b>	
B1 bracket, 2-in. pipe mount, CS bolts	03151-9272-0001
B2 bracket, panel mount, CS bolts	03151-9272-0002
B3 flat bracket for 2-in. pipe mount, CS bolts	03151-9272-0003
B7 (B1 style bracket with SST bolts)	03151-9272-0007
B8 (B2 style bracket with SST bolts)	03151-9272-0008
B9 (B3 style bracket with SST bolts)	03151-9272-0009
BA (SST B1 bracket with SST bolts)	03151-9272-0011
BC (SST B3 bracket with SST bolts)	03151-9272-0013
<b>Bolt kits</b>	
<b>Coplanar flange</b>	
<b>Flange bolt kit (44 mm [1.75-in.])</b>	
CS (set of four)	03151-9280-0001
316 SST (set of four)	03151-9280-0002
ANSI/ASTM-A-193-B7M (set of four)	03151-9280-0003
Alloy K-500 (set of four)	03151-9280-0004
<b>Flange/adaptor bolt kit (73 mm [2.88-in.])</b>	
CS (set of four)	03151-9281-0001
316 SST (set of four)	03151-9281-0002
ANSI/ASTM-A-193-B7M (set of four)	03151-9281-0003
Alloy K-500 (set of four)	03151-9281-0004
<b>Manifold/flange kit (57 mm [2.25-in.])</b>	
CS (set of four)	03151-9282-0001
316 SST (set of four)	03151-9282-0002
ANSI/ASTM-A-193-B7M (set of four)	03151-9282-0003
Alloy K-500 (set of four)	03151-9282-0004

<b>Traditional flange</b>	
<b>Differential flange and adapter bolt kit</b>	
CS (set of eight)	03151-9283-0001
316 SST (set of eight)	03151-9283-0002
ANSI/ASTM-A-193-B7M (set of eight)	03151-9283-0003
Alloy K-500 (set of eight)	03151-9283-0004
<b>Gage/absolute flange and adapter bolt kit</b>	
CS (set of six)	03151-9283-1001
<b>Temperature cables</b>	
<b>AL housing with 1/2-14 NPT conduit (kit includes cable and cable glands)</b>	
RTD input with 12 ft. (3,66 m) of shielded cable	03151-9064-0012
RTD input with 24 ft. (7,32 m) of shielded cable	03151-9064-0024
RTD input with 75 ft. (22,86 m) of shielded cable	03151-9064-0075
RTD input with 27-in. (69 cm) of armored cable	03151-9065-0002
RTD input with 4 ft. (1,22 m) of armored cable	03151-9065-0004
RTD input with 12 ft. (3,66 m) of armored cable	03151-9065-0012
RTD input with 24 ft. (7,32 m) of armored cable	03151-9065-0024
RTD input with 75 ft. (22,86 m) of armored cable	03151-9065-0075
RTD Input with 25-in. (64 cm) of ATEX/IECEx Flameproof cable	03151-9066-0002
RTD input with 12 ft. (3,66 m) of ATEX/IECEx Flameproof cable	03151-9066-0012
<b>Temperature cables</b>	
<b>AL housing with 1/2-14 NPT conduit (kit includes cable and cable glands)</b>	
RTD input with 24 ft. (7,32 m) of ATEX/IECEx Flameproof cable	03151-9066-0024
RTD input with 75 ft. (22,86 m) of ATEX/IECEx Flameproof cable	03151-9066-0075
<b>SST housing with 1/2-14 NPT conduit (kit includes cable and cable glands)</b>	
RTD input with 12 ft. (3,66 m) of shielded cable	03151-9064-0012
RTD input with 24 ft. (7,32 m) of shielded cable	03151-9064-0024
RTD input with 75 ft. (22,86 m) of shielded cable	03151-9064-0075
RTD input with 27-in. (69 cm) of armored cable	03151-9065-0102
RTD input with 4 ft. (1,22 m) of armored cable	03151-9065-0104
RTD input with 12 ft. (3,66 m) of armored cable	03151-9065-0112
RTD input with 24 ft. (7,32 m) of armored cable	03151-9065-0124
RTD input with 75 ft. (22,86 m) of armored cable	03151-9065-0175
RTD input with 25-in. (64 cm) of ATEX/IECEx Flameproof cable	03151-9066-0102
RTD input with 12 ft. (3,66 m) of ATEX/IECEx Flameproof cable	03151-9066-0112
RTD input with 24 ft. (7,32 m) of ATEX/IECEx Flameproof cable	03151-9066-0124
RTD input with 75 ft. (22,86 m) of ATEX/IECEx Flameproof cable	03151-9066-0175

<b>AL housing with M20 x 1.5 conduit (kit includes cable and cable glands)</b>	
RTD input with 12 ft. (3,66 m) of shielded cable	03151-9064-0012
RTD input with 24 ft. (7,32 m) of shielded cable	03151-9064-0024
RTD input with 75 ft. (22,86 m) of shielded cable	03151-9064-0075
RTD input with 27-in. (69 cm) of armored cable	03151-9065-0202
RTD input with 4 ft. (1,22 m) of armored cable	03151-9065-0204
RTD input with 12 ft. (3,66 m) of armored cable	03151-9065-0212
RTD input with 24 ft. (7,32 m) of armored cable	03151-9065-0224
RTD input with 75 ft. (22,86 m) of armored cable	03151-9065-0275
RTD input with 25-in. (64 cm) of ATEX/IECEx Flameproof cable	03151-9066-0202
RTD input with 12 ft. (3,66 m) of ATEX/IECEx Flameproof cable	03151-9066-0212
RTD input with 24 ft. (7,32 m) of ATEX/IECEx Flameproof cable	03151-9066-0224
RTD input with 75 ft. (22,86 m) of ATEX/IECEx Flameproof cable	03151-9066-0275
<b>SST housing with M20 x 1.5 conduit (kit includes cable and cable glands)</b>	
RTD input with 12 ft. (3,66 m) of shielded cable	03151-9064-0012
RTD input with 24 ft. (7,32 m) of shielded cable	03151-9064-0024
RTD input with 75 ft. (22,86 m) of shielded cable	03151-9064-0075
RTD input with 27-in. (69 cm) of armored cable	03151-9065-0302
RTD input with 4 ft. (1,22 m) of armored cable	03151-9065-0304
RTD input with 12 ft. (3,66 m) of armored cable	03151-9065-0312
<b>Temperature cables</b>	
<b>SST housing with M20 x 1.5 conduit (kit includes cable and cable glands)</b>	
RTD input with 24 ft. (7,32 m) of armored cable	03151-9065-0324
RTD input with 75 ft. (22,86 m) of armored cable	03151-9065-0375
RTD input with 25-in. (64 cm) of ATEX/IECEx Flameproof cable	03151-9066-0302
RTD input with 12 ft. (3,66 m) of ATEX/IECEx Flameproof cable	03151-9066-0312
RTD input with 24 ft. (7,32 m) of ATEX/IECEx Flameproof cable	03151-9066-0324
RTD input with 75 ft. (22,86 m) of ATEX/IECEx Flameproof cable	03151-9066-0375
<b>Rosemount 4088 User Interface Software</b>	
Rosemount Transmitter Interface Software (RTIS) CD only	04088-9000-0001
Rosemount Transmitter Interface Software (RTIS) CD with HART USB modem and cables	04088-9000-0002
HART USB modem and cables	03095-5105-0002



## Global Headquarters

### Emerson Automation Solutions

6021 Innovation Blvd.  
Shakopee, MN 55379, USA  
+1 800 999 9307 or +1 952 906 8888  
+1 952 949 7001  
RFQ.RMD-RCC@Emerson.com

## North America Regional Office

### Emerson Automation Solutions

8200 Market Blvd.  
Chanhassen, MN 55317, USA  
+1 800 999 9307 or +1 952 906 8888  
+1 952 949 7001  
RMT-NA.RCCRFQ@Emerson.com

## Latin America Regional Office

### Emerson Automation Solutions

1300 Concord Terrace, Suite 400  
Sunrise, FL 33323, USA  
+1 954 846 5030  
+1 954 846 5121  
RFQ.RMD-RCC@Emerson.com

## Europe Regional Office

### Emerson Automation Solutions Europe GmbH

Neuhofstrasse 19a P.O. Box 1046  
CH 6340 Baar  
Switzerland  
+41 (0) 41 768 6111  
+41 (0) 41 768 6300  
RFQ.RMD-RCC@Emerson.com

## Asia Pacific Regional Office

### Emerson Automation Solutions Asia Pacific Pte Ltd

1 Pandan Crescent  
Singapore 128461  
+65 6777 8211  
+65 6777 0947  
Enquiries@AP.Emerson.com

## Middle East and Africa Regional Office

### Emerson Automation Solutions

Emerson FZE P.O. Box 17033  
Jebel Ali Free Zone - South 2  
Dubai, United Arab Emirates  
+971 4 8118100  
+971 4 8865465  
RFQ.RMTMEA@Emerson.com



LinkedIn.com/company/Emerson-Automation-Solutions



Twitter.com/Rosemount\_News



Facebook.com/Rosemount



Youtube.com/user/RosemountMeasurement



Google.com/+RosemountMeasurement

Standard Terms and Conditions of Sale can be found on the [Terms and Conditions of Sale page](#).

The Emerson logo is a trademark and service mark of Emerson Electric Co. Coplanar, MultiVariable, Rosemount, and Rosemount logotype are trademarks of Emerson.

Microsoft is a registered trademark of Microsoft Corporation in the United States and other countries.

Windows is a trademark of Microsoft Corporation in the United States and other countries.

MACTek and VIATOR are registered trademarks of MACTek Corporation.

HART is a registered trademark of the FieldComm Group.

DTM is a trademark of the FDT Group.

FDT is a registered trademark of the FDT Group.

Modbus is a registered trademark of Gould Inc.

ControlWave, FloBoss, ROCLINK, and Bristol are trademarks of Remote Automation Solutions, a subsidiary of Emerson.

Viton is a registered trademark of DuPont.

SYLTHERM is a trademark of Dow Corning Corporation.

D.C. Silicone 704 is a registered trademark of Dow Corning Corporation.

Fluorinert is a trademark of 3M.

Neobee is a registered trademark of Stepan Specialty Products, LLC.

All other marks are the property of their respective owners.

© 2018 Emerson. All rights reserved.