

Fisher™ 655 and 655R Actuators for Self-Operated Control

Fisher 655 and 655R diaphragm actuators, in combination with Fisher valves, provide control for a wide variety of pressure regulation applications. The 655 is used for pressure reduction service on push-down-to-close valves, and the 655R is primarily for pressure relief use on push-down-to-open valves. These actuators may be either self-operated or remote-loaded.

Features

- **Versatility**—Typical industrial service includes pressure control of water, steam, oil, gas, and other fluids. Actuators can be operated by pneumatic switches, solenoid valves, pilot valves, or remote panel loaders for shutoff service.
- **Large Valve Body Selection**—easy-e valves up through the NPS 4 (NPS 6 for Fisher EA angle valves) with wide choice of end connections, flow directions, flow characteristics, valve plug designs, and seating constructions can be specified.
- **Broad Actuator Spring Selection**—Spring of the proper rate is available for nearly any control valve application. Spring selection procedure is quick and accurate.
- **Severe Service Capability**—Rugged yoke and casings help provide stability and corrosion protection.
- **Fast Acting**—Direct-operated configuration provides faster speed of response.



W2239

Fisher 655R on Reverse-acting easy-e™ Valve Body



W0451-1

Fisher 655-ED Construction Details

Specifications

Maximum Actuator Temperature Capability

150°F with standard diaphragm material⁽¹⁾

Actuator Sizes and Maximum Casing Ratings

Size	Maximum Casing Pressure, Psig
3A, 4A	250
3B, 4B	175
32, 42	100
33, 43	65
34, 44	45
35, 45	30
36, 46	15

Actuator Pressure Setting Ranges

655: See table 3
655R: See table 1

Actuator Yoke Boss Diameters and Valve Stem Connections

Sizes 3A-36: ■ 2-1/8 inch yoke boss with ■ 3/8 inch stem connection
 Sizes 4A-46: ■ 2-13/16 inch yoke boss with ■ 1/2 inch stem connection

Actuator Travel Information

Maximum Rated Travels:

Sizes 3A and 4A: 0.4375 inch plus 0.125 inch for seating

All Other Sizes: 0.75 inch plus 0.125 inch for seating

Other Travel Information: See tables 3, 1, and 2

Effective Diaphragm Areas

See table 2

Actuator Construction Materials

See table 4

Valve Body Flow Coefficients

See Fisher Catalog 12

Actuator Casing Connection

1/2 - 14 NPT

Actuator Options

- Travel indicator
- Casing-mounted handwheel/adjustable travel stop
- Steel upper diaphragm for sizes A and B
- PTFE diaphragm protectors
- Fluorocarbon diaphragm for high temperature service (up to 149°C [300°F])

1. Consult your [Emerson sales office](#) or Local Business Partner for fluid and temperature capabilities of nonstandard diaphragm materials.

Table 1. Fisher 655R Pressures and Sensitivities at 0.4375 Inch Maximum Travel⁽¹⁾ (Relief Service)

SPRING INFORMATION	PART NUMBER		1E7933	1E7954	1E7924	1F7143	1F1769	1F1768	1F1767	1F7144	1F7130							
			27082	27082	27082	27092	27092	27092	27032	27112	27112							
	Spring Rate, Pounds per Inch		2100	1770	1470	830	612	490	368	246	123							
Safe Load, Pounds		3045	2600	2200	1630	1170	1060	843	545	290								
Actuator Pressure Settings Ranges, Psig	Sizes 3A and 4A	Minimum	NA ⁽³⁾	NA ⁽³⁾	65 ⁽⁴⁾	43 ⁽⁵⁾	37 ⁽⁵⁾	34 ⁽⁵⁾	20 ⁽⁵⁾	NA ⁽³⁾	NA ⁽³⁾							
		Maximum ⁽²⁾	NA ⁽³⁾	NA ⁽³⁾	146	119	85	75	57									
	Minimum, Sizes 3B and 4B		43 ⁽⁴⁾	35 ⁽⁴⁾	29 ⁽⁴⁾	19 ⁽⁵⁾	17 ⁽⁵⁾	NA ⁽³⁾	NA ⁽³⁾			NA ⁽³⁾						
	Maximum ⁽²⁾	Size 3B	64	64	64	53	38											
		Size 4B	89	77														
	Minimum, Sizes 32 and 42		26 ⁽⁴⁾	22 ⁽⁴⁾	18 ⁽⁴⁾	12 ⁽⁵⁾	NA ⁽³⁾						NA ⁽³⁾	NA ⁽³⁾				
	Maximum ⁽²⁾	Size 32	38	38	38	31												
		Size 42	53	45														
	Minimum, Sizes 33 and 43		16 ⁽⁴⁾	13 ⁽⁴⁾	11 ⁽⁴⁾	7 ⁽⁵⁾	6.5 ⁽⁵⁾								NA ⁽³⁾	NA ⁽³⁾		
	Maximum ⁽²⁾	Size 33	24	24	24	20	14.5 ⁽⁶⁾											
		Size 43	33	28														
	Minimum, Sizes 34 and 44		11 ⁽⁴⁾	9 ⁽⁴⁾	7 ⁽⁴⁾	5 ⁽⁵⁾	4 ⁽⁵⁾								4.1 ⁽⁵⁾		7.9 ⁽⁶⁾	NA ⁽³⁾
	Maximum ⁽²⁾	Size 34	16	16	16	13	10											
		Size 44	23	19														
	Minimum, Sizes 35 and 45		7 ⁽⁴⁾	5.5 ⁽⁴⁾	5 ⁽⁴⁾	3.2 ⁽⁵⁾	2.8 ⁽⁵⁾								2.5 ⁽⁵⁾		1.5 ⁽⁵⁾	
Maximum ⁽²⁾	Size 35	11	11	11	9	6.3	5.5 ⁽⁶⁾			4.2 ⁽⁶⁾	2.8 ⁽⁶⁾							
	Size 45	15	13															
Minimum, Sizes 36 and 46		5 ⁽⁴⁾	4.2 ⁽⁴⁾	3.5 ⁽⁴⁾	2.3 ⁽⁵⁾	2 ⁽⁵⁾	1.8 ⁽⁵⁾	1.1 ⁽⁵⁾	.9 ⁽⁵⁾	.7 ⁽⁵⁾								
Maximum ⁽²⁾	Size 36	7.7	7.7	7.7	6.3	4.5	4 ⁽⁶⁾	3 ⁽⁶⁾	2 ⁽⁶⁾	1 ⁽⁶⁾								
	Size 46	10.5	9															
Actuator Sensitivities, Inches of Travel Obtained per Psig of Change ⁽⁷⁾	Sizes 3A and 4A		NA ⁽³⁾	NA ⁽³⁾	.0064	.0098	.0131	.0163	.0216	NA ⁽³⁾	NA ⁽³⁾							
	Sizes 3B and 4B		.0087	.0103	.0124	.0209	.0286	NA ⁽³⁾	NA ⁽³⁾									
	Sizes 32 and 42		.013	.015	.018	.0294	NA ⁽³⁾											
	Size 33 and 43		.022	.026	.031	.051	.069											
	Sizes 34 and 44		.033	.039	.046	.078	.104	.128	.278			.416						
	Sizes 35 and 45		.052	.061	.076	.126	.169	.214										
	Sizes 36 and 46		.076	.089	.106	.183	.250	.309	.410			.603	1.19					

1. Effects of packing box friction, unbalance & weight of valve plug not considered in calculations.
2. Greatest allowable pressure (with the valve closed) that will not exceed the safe load of the actuator spring but will still allow 0.4375 inch travel.
3. This spring-actuator size combination not available.
4. Least pressure required (at 0.25 inch travel) to assure 1/8 inch spring compression.
5. Least pressure required (at 0.25 inch travel) to assure 200 pounds of seating force.
6. Limited by adjusting screw.
7. Average for minimum and maximum pressures at zero and 0.25 inch travel.

Table 2. Effective Diaphragm Area, Square Inches

ACTUATOR SIZE	INCHES TRAVEL DOWN FROM UPPER CASING STOP									
	0	0.125	0.1875	0.25	0.375	0.4375	0.5	0.5625	0.75	0.875
3A, 4A	10.2	9.6	9.5	9.4	9.2	9.1	8.9	8.7	7.4	6
3B, 4B	23.5	21.6	21.1	20.8	20.5	20.3	20.1	19.8	18.1	16
32, 42	40	36.4	35.2	34.2	32.6	31.8	31	30.3	28.2	26.4
33, 43	63	58	56.8	55.5	53.5	52.7	52	51.2	49.3	47.6
34, 44	93	84.8	82.8	81	78.8	77.8	77	76	73.5	72
35, 45	134	129.2	127.2	125.4	122.2	120.5	119	117.6	114.1	112
36, 46	190	181.5	179	177	173.5	172.3	171	169.8	166.5	163.5

Table 3. Fisher 655 Pressures and Sensitivities at 0.4375 Inch Maximum Travel⁽¹⁾ (Reducing Service)

SPRING INFORMATION	PART NUMBER		1E7933	1E7954	1E7924	1F7143	1F1769	1F1768	1F1767	1F7144	1F7130														
			27082	27082	27082	27092	27092	27092	27032	27112	27112														
	Spring Rate, Pounds per Inch		2100	1770	1470	830	612	490	368	246	123														
Safe Load, Pounds		3045	2600	2200	1630	1170	1060	843	545	290															
Actuator Pressure Setting Ranges, Psig	Sizes 3A and 4A	Minimum ⁽²⁾	NA ⁽⁴⁾	NA ⁽⁴⁾	78	44	32	26	19	NA ⁽⁴⁾	NA ⁽⁴⁾														
		Maximum ⁽³⁾	NA ⁽⁴⁾	NA ⁽⁴⁾	174	135	96	78 ⁽⁵⁾	59 ⁽⁵⁾																
	Sizes 3B and 4B	Minimum ⁽²⁾	50	42	35	20	14	NA ⁽⁴⁾	NA ⁽⁴⁾																
		Maximum ⁽³⁾	107	92	78	60	43																		
	Sizes 32 and 42	Minimum ⁽²⁾	32	26	22	12	NA ⁽⁴⁾					NA ⁽⁴⁾	NA ⁽⁴⁾												
		Maximum ⁽³⁾	65	55	47	36																			
	Sizes 33 and 43	Minimum ⁽²⁾	19	16	14	7	5.2							NA ⁽⁴⁾	NA ⁽⁴⁾										
		Maximum ⁽³⁾	40	34	29	22	16																		
	Sizes 34 and 44	Minimum ⁽²⁾	13	11	9	5	3.8									NA ⁽⁴⁾	NA ⁽⁴⁾								
		Maximum ⁽³⁾	27.5	23.4	20	15.5	11											8.5							
	Sizes 35 and 45	Minimum ⁽²⁾	8.3	7	5.8	3.3	2.4											NA ⁽⁴⁾	NA ⁽⁴⁾						
		Maximum ⁽³⁾	17.8	15.2	13	10	7.2													5.9 ⁽⁵⁾	4.4 ⁽⁵⁾	2.9 ⁽⁵⁾			
	Sizes 36 and 46	Minimum ⁽²⁾	5.8	4.9	4.1	2.3	1.7													NA ⁽⁴⁾	NA ⁽⁴⁾				
		Maximum ⁽³⁾	12.7	10.8	9.2	7.1	5.1															4.2 ⁽⁵⁾	3.1 ⁽⁵⁾	0.7	0.34
Actuator Sensitivities, Inches of Travel Obtained per Psig of Change ⁽⁶⁾	Sizes 3A and 4A		NA ⁽⁴⁾	NA ⁽⁴⁾	0.0055	0.0095	0.0121			0.0161	0.0212											NA ⁽⁴⁾	NA ⁽⁴⁾		
	Sizes 3B and 4B		0.0087	0.0103	0.0126	0.0217	0.029			NA ⁽⁴⁾	NA ⁽⁴⁾														
	Sizes 32 and 42		0.012	0.014	0.017	0.028	NA ⁽⁴⁾	NA ⁽⁴⁾	NA ⁽⁴⁾																
	Sizes 33 and 43		0.021	0.026	0.031	0.050	0.069																	NA ⁽⁴⁾	NA ⁽⁴⁾
	Sizes 34 and 44		0.032	0.037	0.045	0.076	0.104					NA ⁽⁴⁾	NA ⁽⁴⁾												
	Sizes 35 and 45		0.055	0.059	0.072	0.121	0.167																		
Sizes 36 and 46		0.075	0.086	0.106	0.183	0.244	0.303							0.400	0.610							1.21			

1. Effects of packing box friction, unbalance & weight of valve plug not considered in calculations.
 2. Least pressure required to seat the valve and still allow 0.4375 inch travel when the pressure is released.
 3. Greatest allowable pressure (at 0.25 inch travel) that will let the valve be stroked closed without exceeding the safe load of the actuator spring.
 4. This spring-actuator size combination not available.
 5. Limited by adjusting screw.
 6. Average for minimum and maximum pressures at zero and 0.25 inch travels.

Installation

These regulators may be installed in any position, as orientation is not a problem. But for steam service, the control line should be installed so that condensate drains back into the diaphragm casing, thus maintaining a water seal on the diaphragm. A strainer (such as the Fisher 262K) is always recommended ahead of the valve body to protect body and trim from damaging particles.

Dimensions are given in figure 1. Refer to the appropriate instructions before installing the regulator.

Ordering Information

When ordering, specify:

1. All information requested in the Ordering Information section of the valve body bulletin.
2. Actuator type number and size
3. Actuator travel
4. Valve plug stem diameter and connection size
5. Desired regulator orientation in pipeline
6. Magnitude and type of remote loading pressure, if applicable (for instance, 3-15 psig controller output signal)
7. Desired actuator options

Figure 1. Actuator Dimensions, Inches (also see table 5)

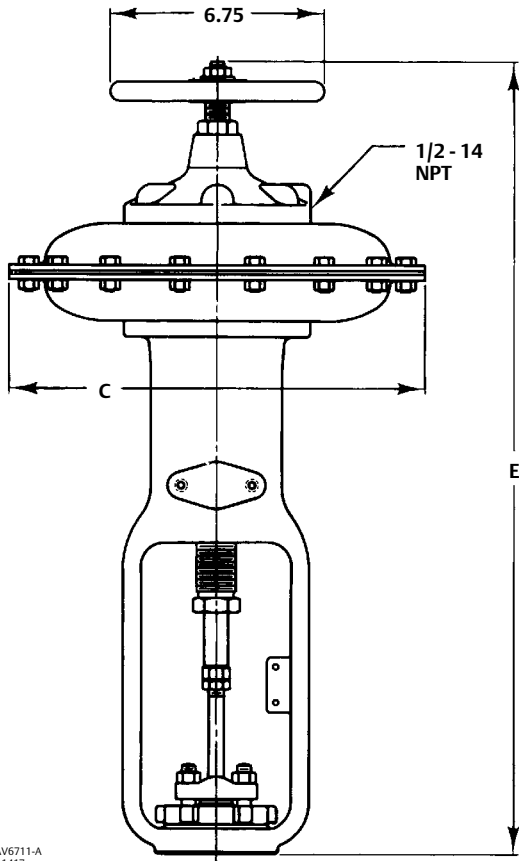

AV6711-A
A1417

Table 4. Actuator Construction Materials

Part	Material	
Diaphragm casings	Sizes 3A, 3B, 4A, and 4B	Cast iron standard, steel available
	All other sizes	Pressed steel, zinc plated
Yoke	Cast iron standard, steel available	
Spring	Steel alloy	
Spring seat	Forged steel	
Travel stop	Steel	
Diaphragm plate	Cast iron	
Diaphragm	CR (Chloroprene) (standard) ⁽¹⁾	
Stem and adjusting screw	Steel, cadmium plated	

1. Consult your [Emerson sales office](#) or Local Business Partner for fluid and temperature capabilities of nonstandard diaphragm materials.

Table 5. Actuator Dimension, Inches

SIZE	C DIAMETER	Without Handwheel	With Handwheel
3A	5.88	17.56	22.44
3B	9.00	18.19	24.50
32	9.88	17.81	23.00
33	11.38	17.81	23.00
34	13.12	18.44	23.62
35	16.00	19.19	24.38
36	18.62	19.19	24.38
4A	5.88	19.50	24.38
4B	9.00	20.12	26.44
42	9.88	19.75	24.94
43	11.38	19.75	24.94
44	13.12	20.38	25.56
45	16.00	21.12	26.31
46	18.62	21.12	26.31

Total Capability of Fisher 655-ED

The following charts (figures 2 through 11) show the complete capability of the 655-ED, including travels greater than 0.25 inch. Included are charts for C_v , C_g , and C_s for the ED valves of various sizes and charts for various casing sizes for the 655 actuator.

An example on the use of the charts follows:

1. Refer to the chart showing the C_v for the ED design. Assume your customer says his normal C_v is 37, but can vary from 30 to 44 and the customer wants to control at 110 psi. The NPS 2 will fit this quite well and at the top of the chart you will notice that this requires a travel from 0.25 inch to 0.375 inch with the normal travel at 0.3125 inch.

2. Next, refer to the curve on the 655-ED, A-CASING chart of diaphragm pressure versus valve travel. Enter the chart at 0.3125 inch valve travel and proceed up until you intersect the 110 psi pressure. You will note that spring drawing 1F7143 is at this intersection. You can then readily see that when the flows vary, the pressure will vary from approximately 118 psi to 105 psi as the valve travels from 0.25 inch to 0.375 inch.

Figure 2. ED Design, Liquid Flow

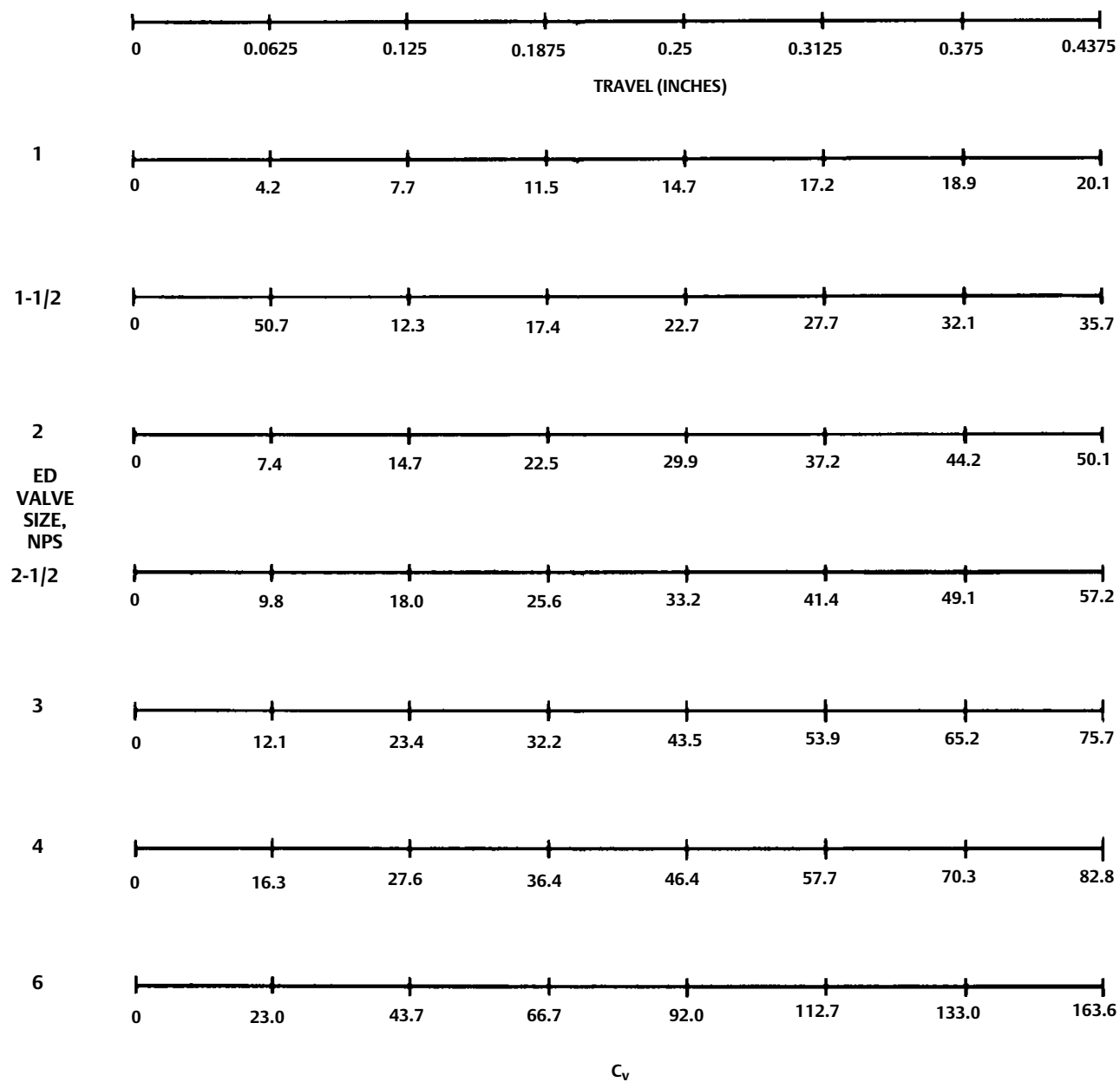

A7057

Figure 3. ED Design, Gas Flow

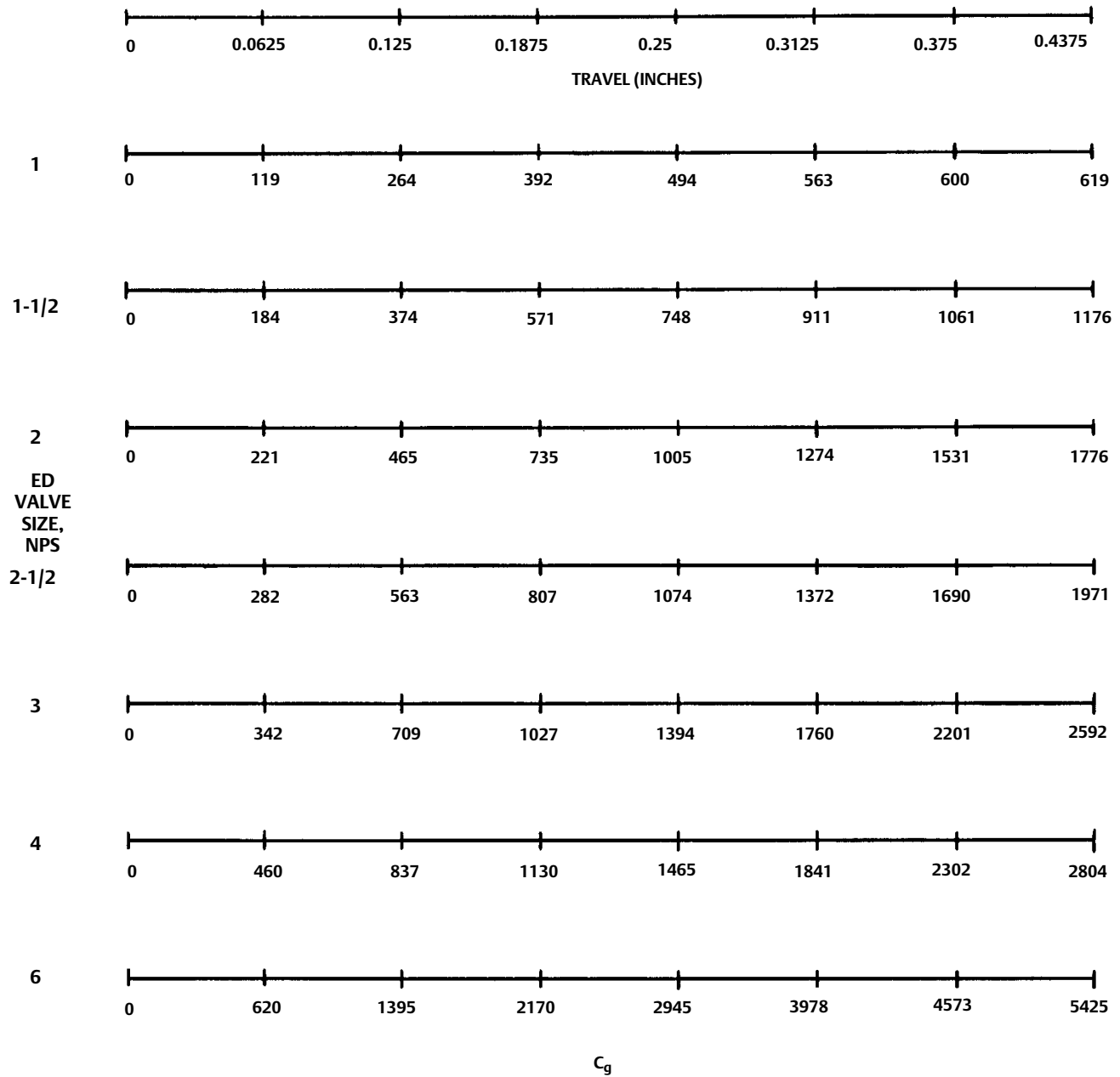
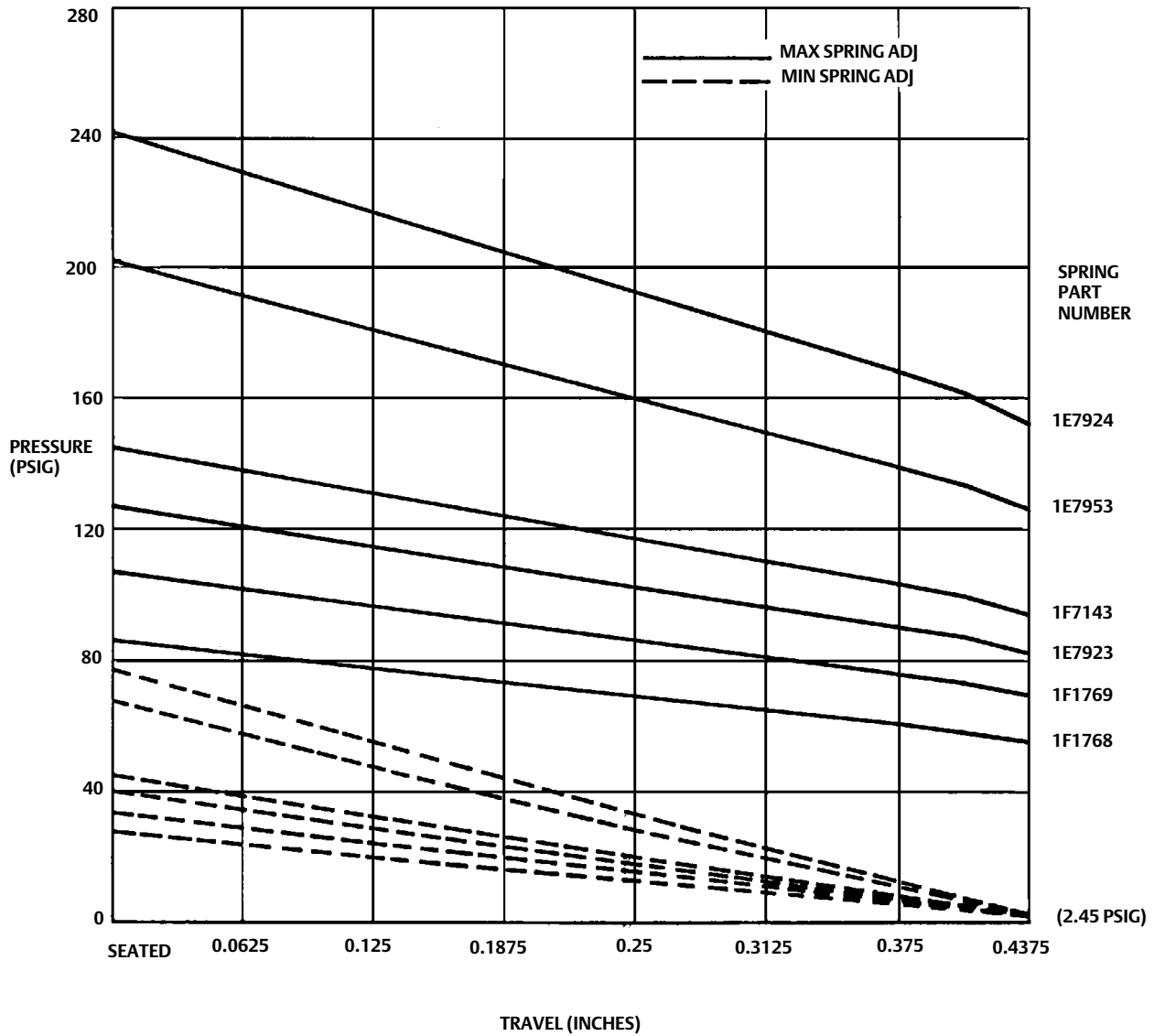

Figure 4. 655 ED, A Casing, Diaphragm Pressure versus Valve Travel



A7059

MAX, MIN CURVES POSITIONED RESPECTIVELY

Figure 5. ED Design, Steam Flow

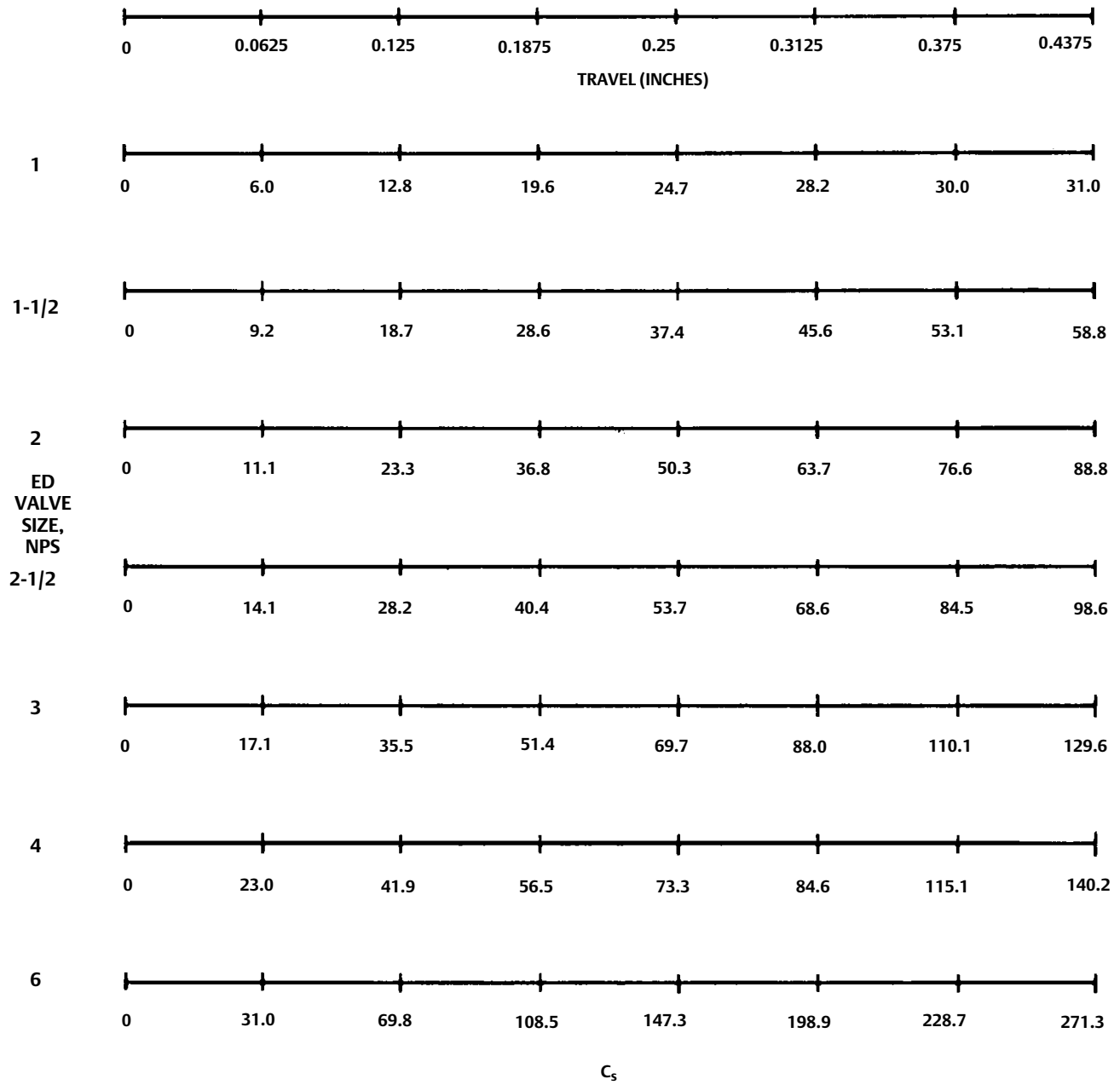

A7060

Figure 6. 655 ED, B Casing, Diaphragm Pressure versus Valve Travel

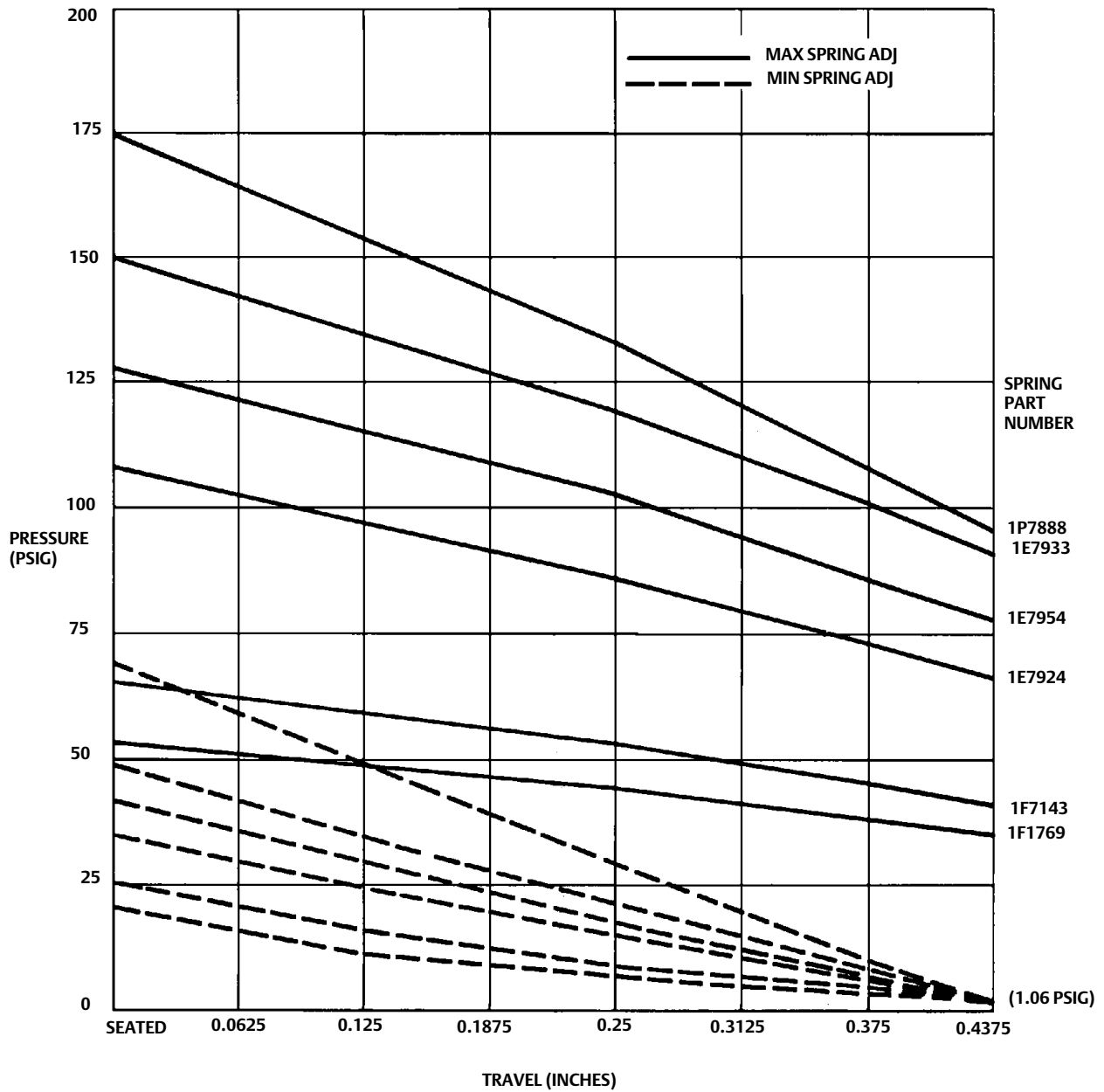

A7061

MAX, MIN CURVES POSITIONED RESPECTIVELY

Figure 7. 655 ED, #20 Casing, Diaphragm Pressure versus Valve Travel

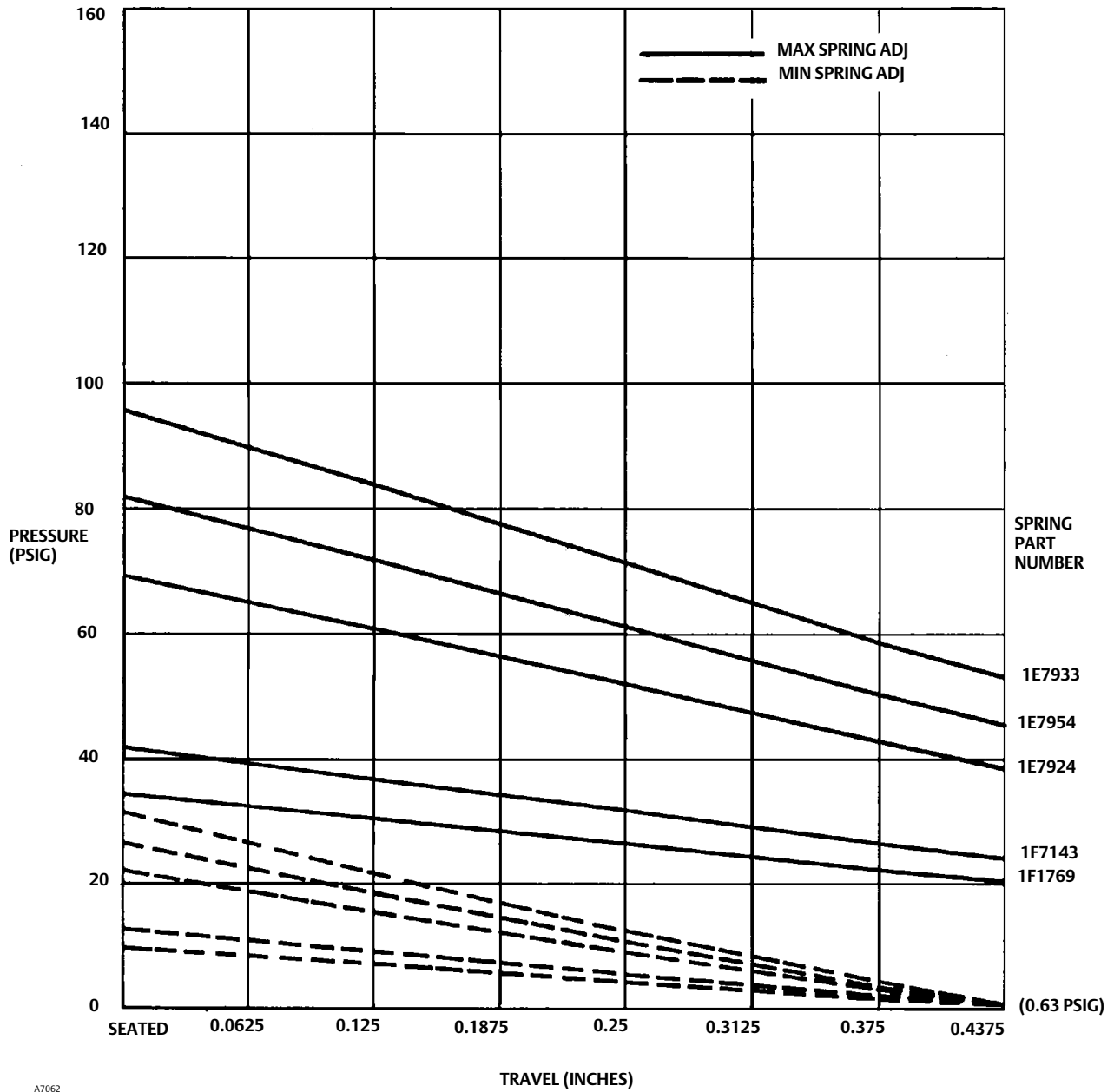

A7062

MAX, MIN CURVES POSITIONED RESPECTIVELY

Figure 8. 655 ED, #30 Casing, Diaphragm Pressure versus Valve Travel

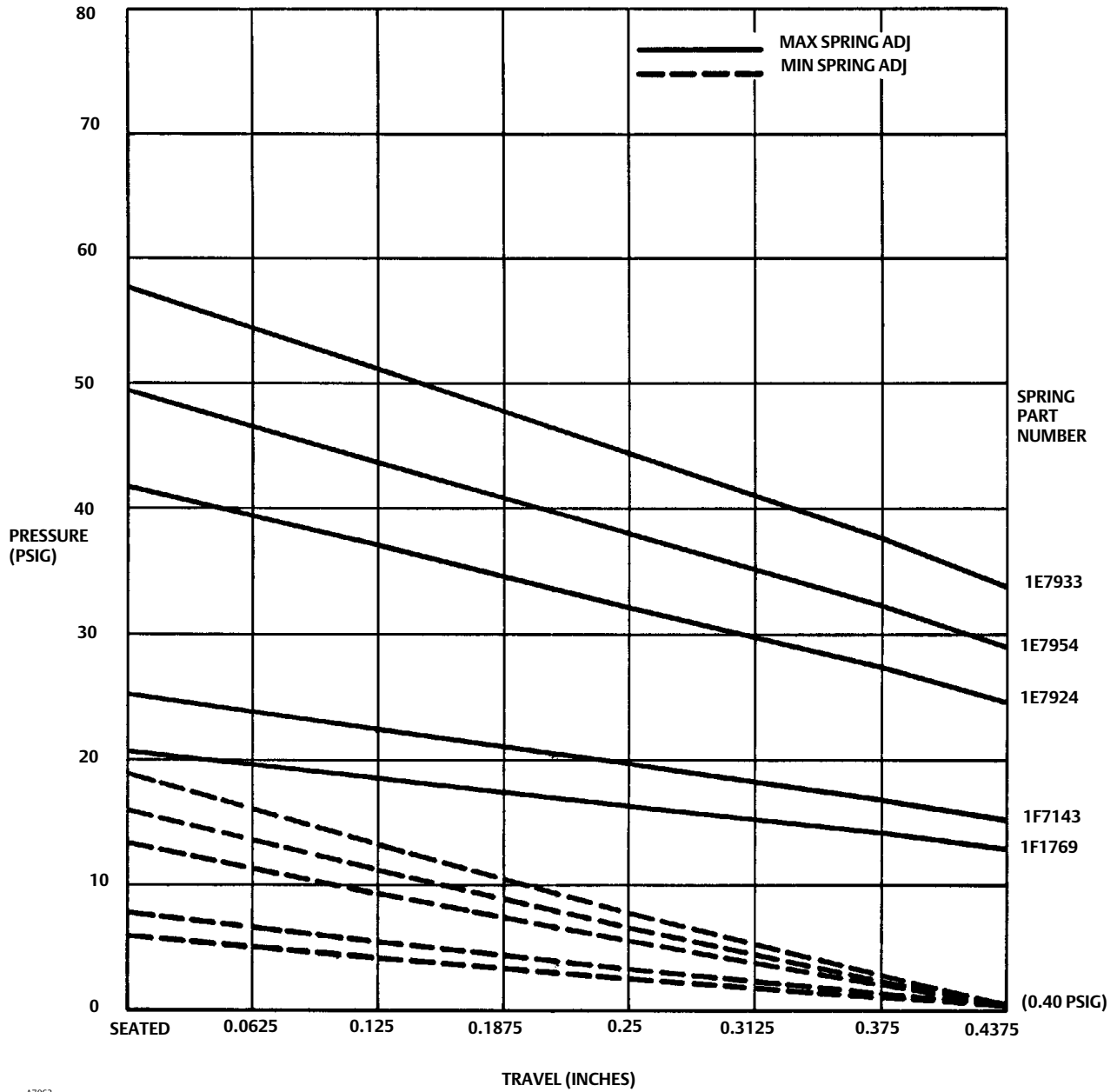

A7063

MAX, MIN CURVES POSITIONED RESPECTIVELY

Figure 9. 655 ED, #40 Casing, Diaphragm Pressure versus Valve Travel

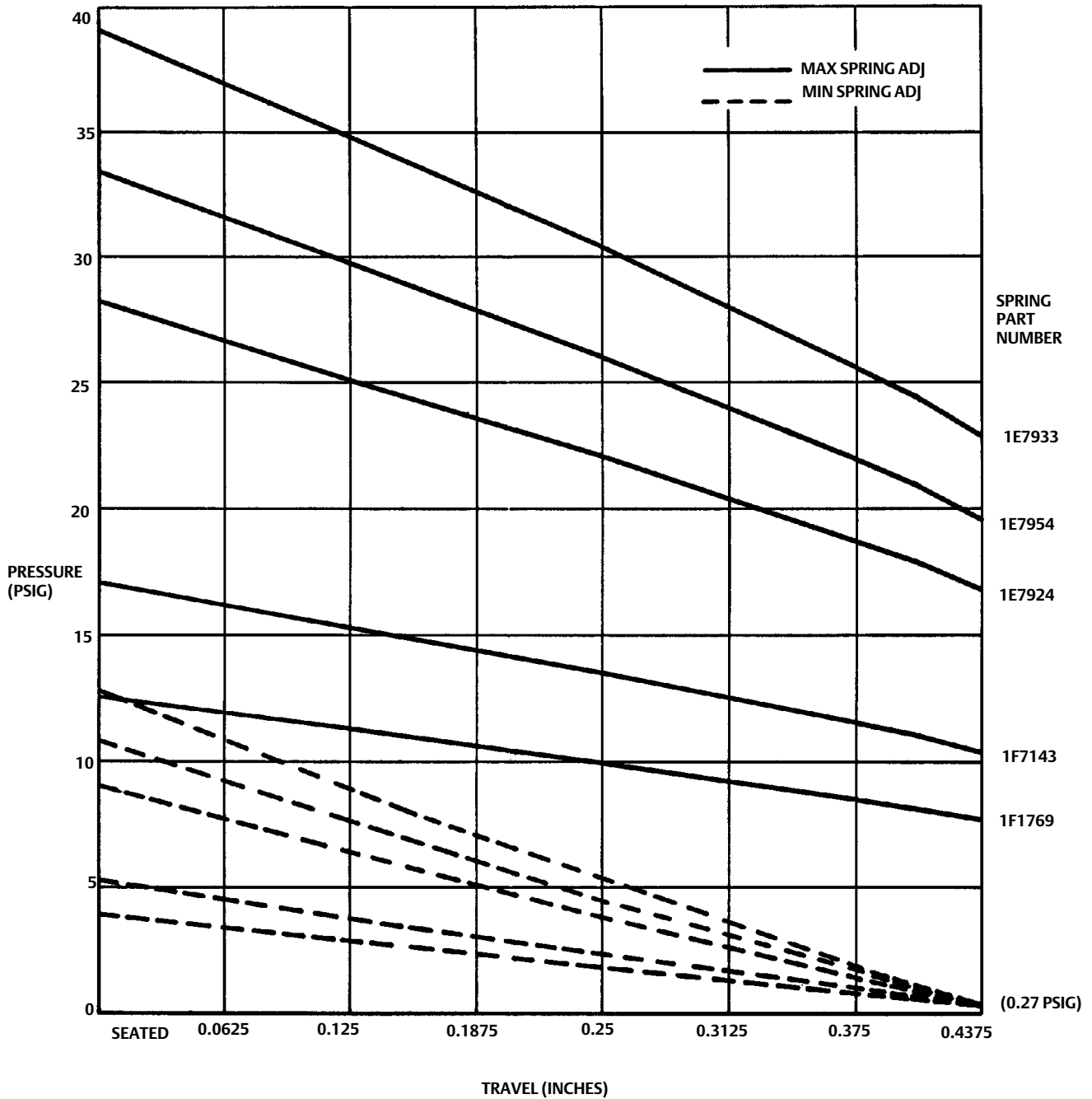

A7064

MAX, MIN CURVES POSITIONED RESPECTIVELY

Figure 10. 655 ED, #50 Casing, Diaphragm Pressure versus Valve Travel

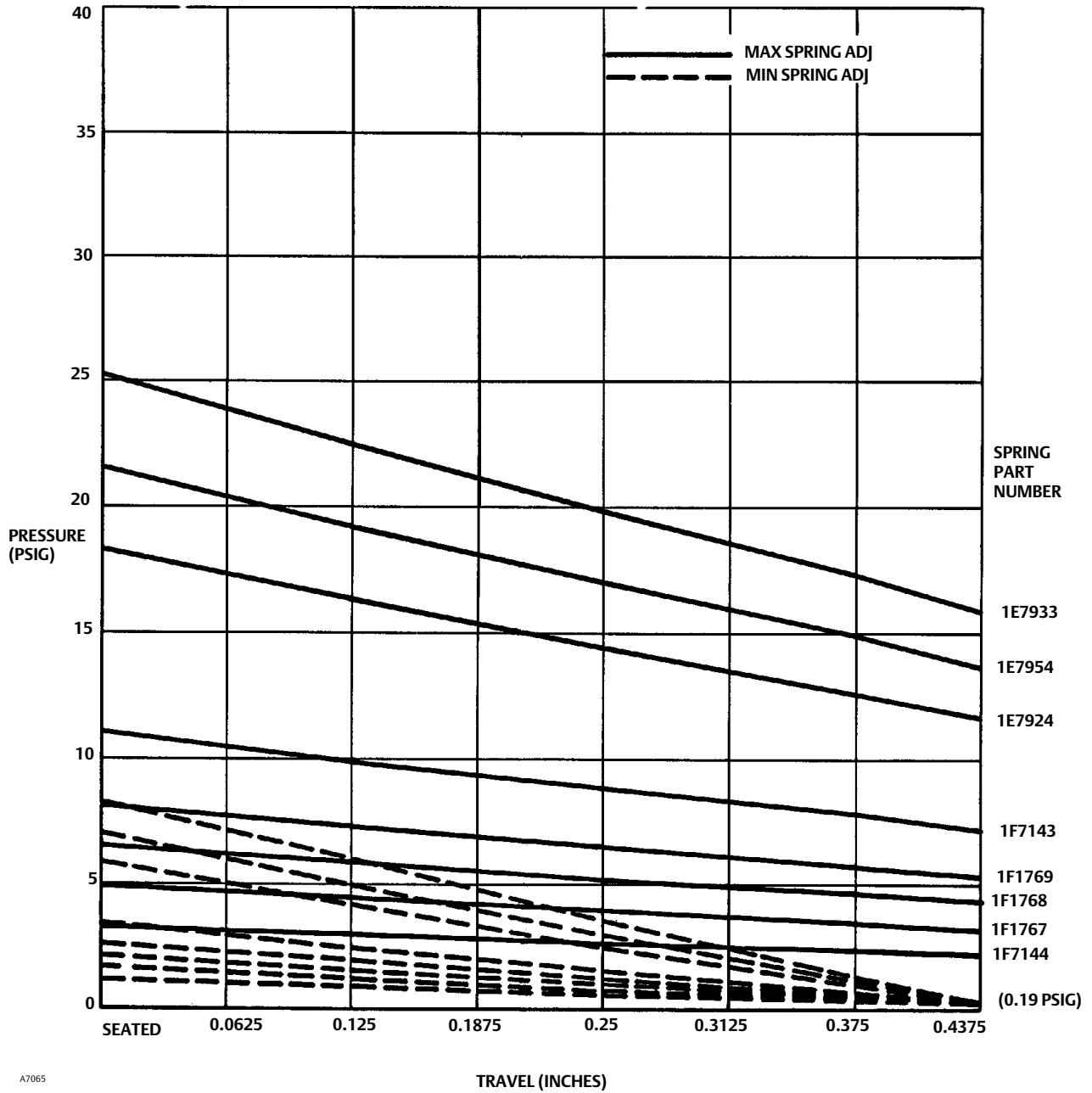

A7065

MAX, MIN CURVES POSITIONED RESPECTIVELY

Figure 11. 655 ED, #60 Casing, Diaphragm Pressure versus Valve Travel

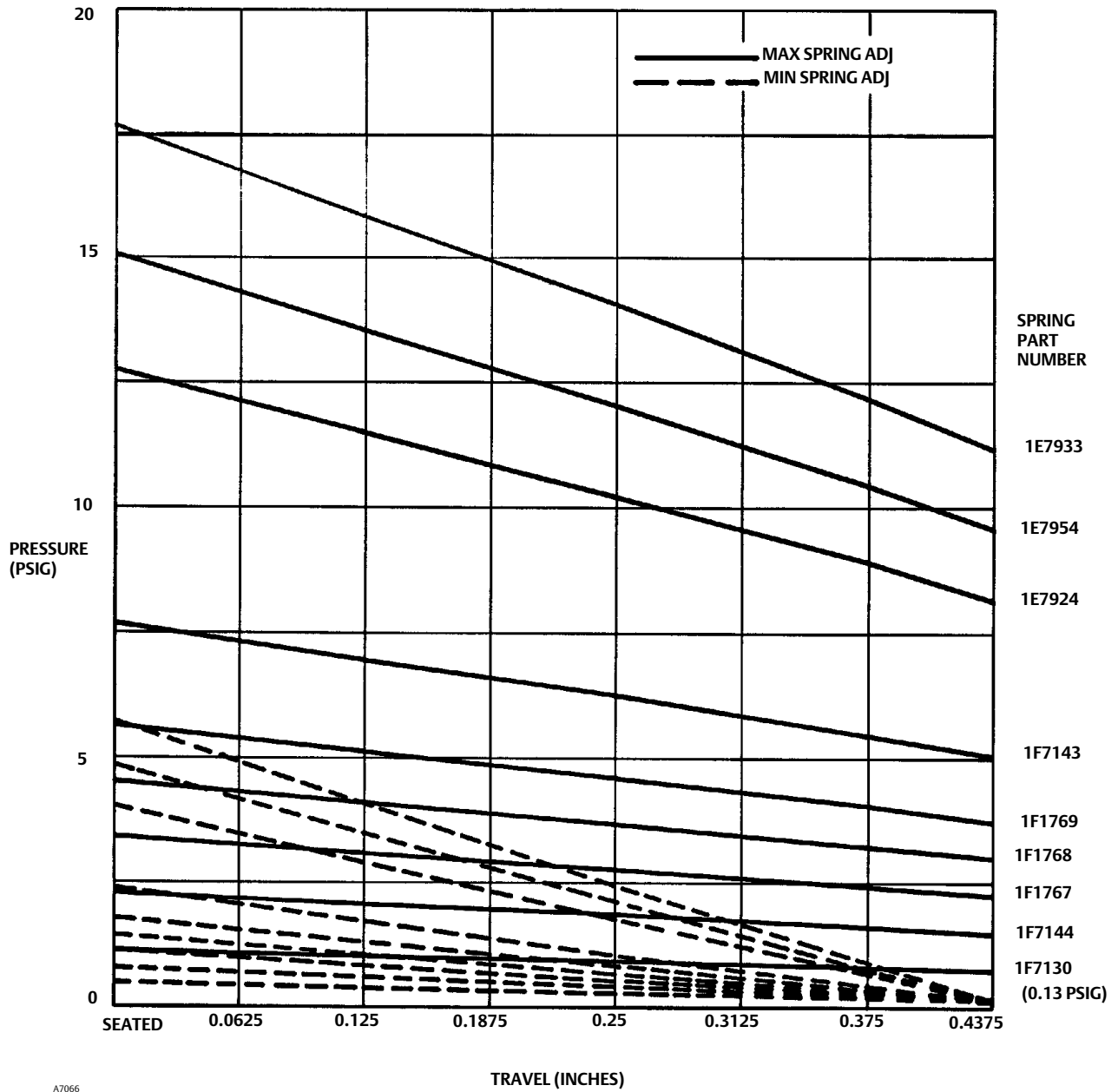

A7066

MAX, MIN CURVES POSITIONED RESPECTIVELY

Neither Emerson, Emerson Automation Solutions, nor any of their affiliated entities assumes responsibility for the selection, use or maintenance of any product. Responsibility for proper selection, use, and maintenance of any product remains solely with the purchaser and end user.

Fisher and easy-e are marks owned by one of the companies in the Emerson Automation Solutions business unit of Emerson Electric Co. Emerson Automation Solutions, Emerson, and the Emerson logo are trademarks and service marks of Emerson Electric Co. All other marks are the property of their respective owners.

The contents of this publication are presented for informational purposes only, and while every effort has been made to ensure their accuracy, they are not to be construed as warranties or guarantees, express or implied, regarding the products or services described herein or their use or applicability. All sales are governed by our terms and conditions, which are available upon request. We reserve the right to modify or improve the designs or specifications of such products at any time without notice.

Emerson Automation Solutions
Marshalltown, Iowa 50158 USA
Sorocaba, 18087 Brazil
Cernay 68700 France
Dubai, United Arab Emirates
Singapore 128461 Singapore

www.Fisher.com

