

Envelope Dimensions and Torque Data

XL221 Double acting and Spring Return actuator

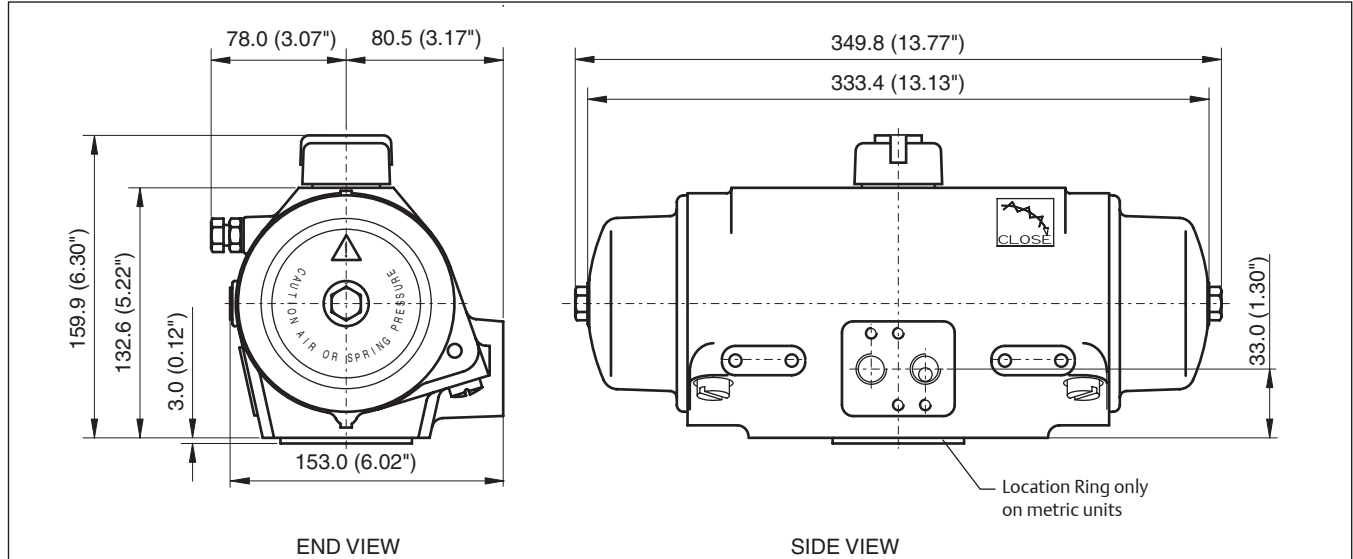

Torque in Nm, Pressure in bar(g)																
Double Acting Torques			91		121		152		167		182		212		243	
Spring Rating	Torque From Springs		3.0 bar(g)		4.0 bar(g)		5.0 bar(g)		5.5 bar(g)		6.0 bar(g)		7.0 bar(g)		8.0 bar(g)	
	Start	End	Start	End	Start	End	Start	End	Start	End	Start	End	Start	End	Start	End
S40	52	31	60	39	90	69	120	99	135	114	151	130	181	160	211	190
S50	65	39	52	26	82	56	112	86	128	101	143	117	173	147	203	177
S60	78	47	44	13	74	43	105	73	120	88	135	104	165	134	196	164
S70	91	55	-	-	66	30	97	60	112	75	127	90	157	121	188	151
S80	105	63	-	-	59	17	89	47	104	62	119	77	150	108	180	138
S90	118	71	-	-	-	-	81	34	96	49	111	64	142	95	172	125
S1C	131	78	-	-	-	-	73	21	88	36	104	51	134	82	164	112

Torque in inch-pounds, Pressure in PSI																
Double Acting Torques			735		919		1103		1470		1654		1838		2205	
Spring Rating	Torque From Springs		40 PSI		50 PSI		60 PSI		80 PSI		90 PSI		100 PSI		120 PSI	
	Start	End	Start	End	Start	End	Start	End	Start	End	Start	End	Start	End	Start	End
S40	463	278	458	273	641	456	825	640	1193	1008	1377	1192	1560	1375	1928	1743
S50	578	347	388	157	572	341	756	525	1123	892	1307	1076	1491	1260	1859	1627
S60	694	416	-	-	503	225	686	409	1054	777	1238	960	1422	1144	1789	1512
S70	809	486	-	-	-	-	617	293	985	661	1168	845	1352	1028	1720	1396
S80	925	555	-	-	-	-	548	178	915	545	1099	729	1283	913	1650	1280
S90	1041	624	-	-	-	-	-	-	846	430	1030	613	1213	797	1581	1165
S1C	1156	694	-	-	-	-	-	-	777	314	960	498	1144	682	1512	1049