

Envelope Dimensions and Torque Data

XL71 Double acting and Spring Return actuator

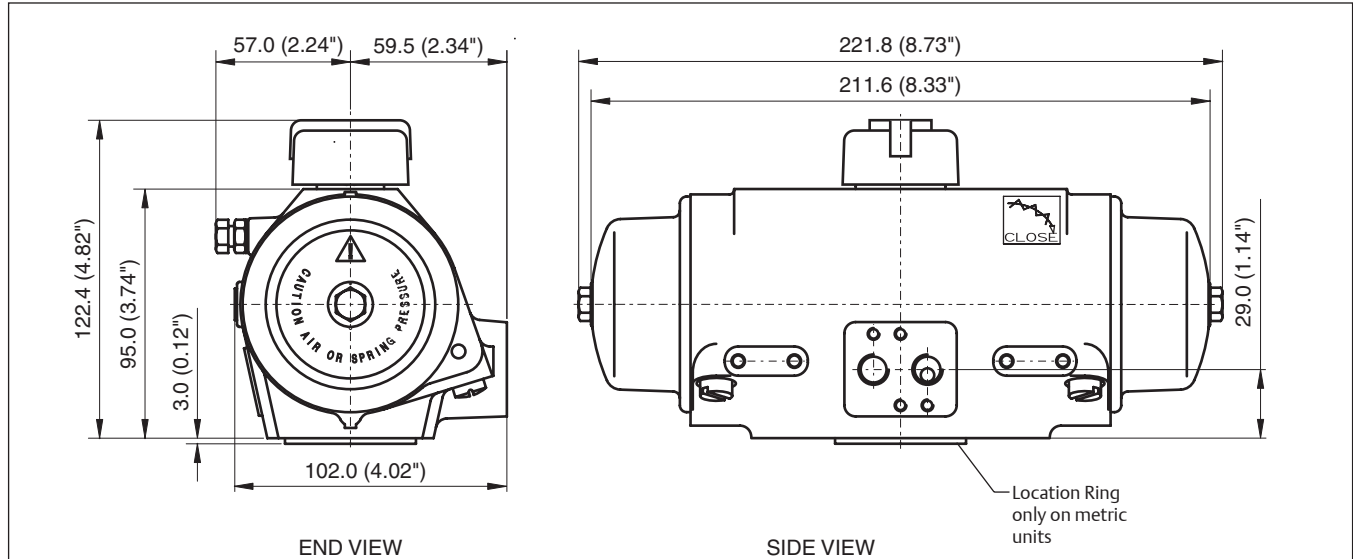

Torque in Nm, Pressure in bar(g)

Double Acting Torques		26		34		43		47		52		60		69		
Spring Rating	Torque From Springs		3.0 bar(g)		4.0 bar(g)		5.0 bar(g)		5.5 bar(g)		6.0 bar(g)		7.0 bar(g)		8.0 bar(g)	
	Start	End	Start	End	Start	End	Start	End	Start	End	Start	End	Start	End	Start	End
S40	15	9	17	11	26	20	34	28	38	32	43	37	51	45	60	54
S50	19	11	15	7	23	16	32	24	36	29	41	33	49	42	58	50
S60	22	13	12	4	21	12	30	21	34	25	38	29	47	38	55	47
S70	26	16	-	-	19	8	27	17	32	21	36	26	45	34	53	43
S80	30	18	-	-	17	5	25	13	30	18	34	22	42	31	51	39
S90	33	20	-	-	-	-	23	10	27	14	32	18	40	27	49	35
S1C	37	22	-	-	-	-	21	6	25	10	29	15	38	23	47	32

Torque in inch-pounds, Pressure in PSI

Double Acting Torques		209		261		313		417		469		521		626		
Spring Rating	Torque From Springs		40 PSI		50 PSI		60 PSI		80 PSI		90 PSI		100 PSI		120 PSI	
	Start	End	Start	End	Start	End	Start	End	Start	End	Start	End	Start	End	Start	End
S40	131	79	130	77	182	130	234	182	338	286	391	338	443	390	547	495
S50	164	98	110	45	162	97	214	149	319	253	371	305	423	357	527	462
S60	197	118	-	-	143	64	195	116	299	220	351	273	403	325	508	429
S70	230	138	-	-	-	-	175	83	279	188	332	240	384	292	488	396
S80	263	158	-	-	-	-	155	50	260	155	312	207	364	259	468	363
S90	295	177	-	-	-	-	-	-	240	122	292	174	344	226	449	331
S1C	328	197	-	-	-	-	-	-	220	89	273	141	325	193	429	298