

Envelope Dimensions and Torque Data

XL1372 Double acting and Spring Return actuator

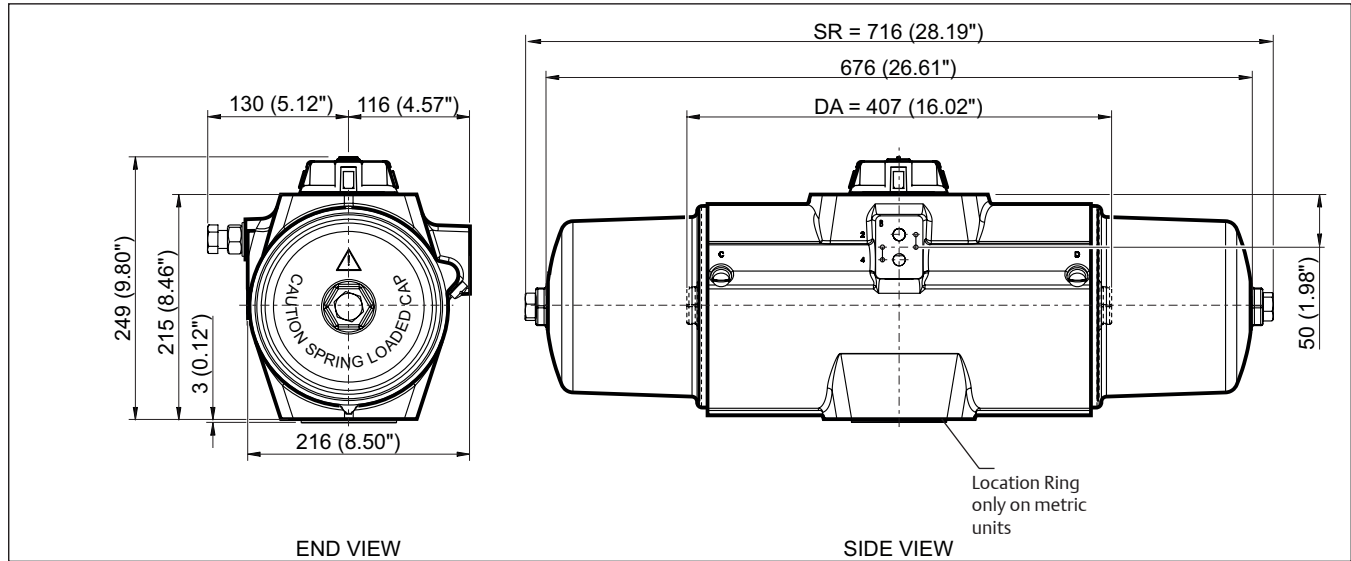

Torque in Nm, Pressure in bar(g)

Double Acting Torques		529		705		882		970		1058		1234		1411		
Spring Rating	Torque From Springs		3.0 bar(g)		4.0 bar(g)		5.0 bar(g)		5.5 bar(g)		6.0 bar(g)		7.0 bar(g)		8.0 bar(g)	
	Start	End	Start	End	Start	End	Start	End	Start	End	Start	End	Start	End	Start	End
S40	304	183	346	225	523	401	699	577	787	665	875	753	1052	930	1228	1106
S50	381	228	301	148	477	325	653	501	741	589	830	677	1006	854	1182	1030
S60	457	274	255	72	431	249	608	425	696	513	784	601	960	778	1137	954
S70	533	320	-	-	386	172	562	349	650	437	738	525	915	701	1091	878
S80	609	365	-	-	340	96	516	273	605	361	693	449	869	625	1045	802
S90	685	411	-	-	-	-	471	197	559	285	647	373	823	549	1000	726
S1C	761	456	-	-	-	-	425	120	513	209	601	297	778	473	954	649

Torque in inch-pounds, Pressure in PSI

Double Acting Torques		4275		5344		6413		8550		9619		10688		12825		
Spring Rating	Torque From Springs		40 PSI		50 PSI		60 PSI		80 PSI		90 PSI		100 PSI		120 PSI	
	Start	End	Start	End	Start	End	Start	End	Start	End	Start	End	Start	End	Start	End
S40	2694	1616	2659	1581	3728	2649	4797	3718	6934	5856	8003	6924	9072	7993	11209	10131
S50	3368	2020	2255	907	3324	1976	4393	3045	6530	5182	7599	6251	8668	7320	10805	9457
S60	4041	2424	-	-	2920	1302	3989	2371	6126	4509	7195	5577	8264	6646	10401	8784
S70	4715	2828	-	-	-	-	3585	1698	5722	3835	6791	4904	7860	5973	9997	8110
S80	5389	3232	-	-	-	-	3181	1024	5318	3161	6387	4230	7456	5299	9593	7436
S90	6062	3636	-	-	-	-	-	-	4914	2488	5983	3557	7052	4625	9189	6763
S1C	6736	4040	-	-	-	-	-	-	4510	1814	5579	2883	6648	3952	8785	6089