

# Rosemount™ 214C Temperature Sensors



## Primary product benefits

- High accuracy resistance temperature detectors (RTD) and various thermocouple types offered in a variety of element configurations
- Calibration capabilities for increased measurement accuracy for RTDs

# Rosemount 214C Temperature Sensors

## Optimize plant efficiency and increase measurement reliability with industry-proven design and specifications

- All sensor styles and lengths available as standard in ¼-in. (6 mm) nominal diameter
- State-of-the-art manufacturing processes providing robust element packaging, increasing reliability
- Industry-leading calibration capabilities allowing for Callendar-Van Dusen values giving increased RTD accuracy when paired with Rosemount transmitters
- Optional Class A accuracy RTDs or Class 1/Special Tolerances thermocouples for critical temperature measurement points

## Explore the benefits of a Complete Point Solution™ from Emerson

- “Transmitter assembled to sensor” and “Thermowell assembled to sensor” options enable Emerson to provide a complete point temperature solution, delivering process-ready or hand-tight transmitter, sensor, and/or thermowell assemblies
- Complete portfolio of Single Point and Multi-Input Temperature Measurement solutions, allowing effective measurement and processes control with the trusted reliability from Rosemount products



### Contents

Rosemount 214C Temperature Sensors.....	2
Rosemount 214C Sensor.....	4
RTD ordering information.....	5
Thermocouple ordering information.....	22
Ordering information detail.....	36
Product certifications.....	52
Additional RTD specifications.....	79
Additional thermocouple specifications.....	81

## Experience global consistency and local support from numerous worldwide Emerson manufacturing sites

- World-class manufacturing provides globally consistent product from every factory and the capacity to fulfill needs of any project, large or small
- Experienced instrumentation consultants help select the right product for any temperature application and offer advice on best installation practices
- Extensive global network of Emerson service and support personnel can be on-site when and where they are needed

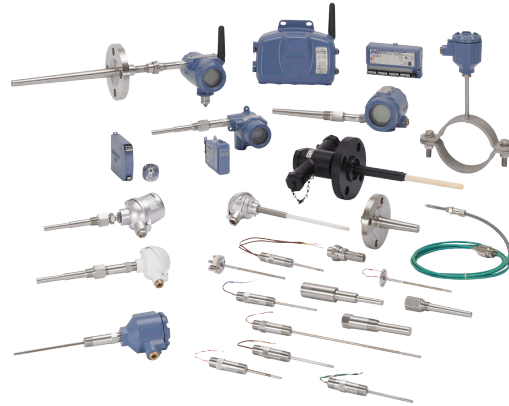

# Rosemount 214C Sensor

The Rosemount 214C Sensors are designed to provide flexible and reliable temperature measurements in process monitoring and control environments.

Features include:

- Temperature ranges of -321 to 1112 °F (-196 to 600 °C) for RTDs and -321 to 2192 °F (-196 to 1200 °C) for thermocouples
- Industry-standard sensor types: PT100 RTDs; thermocouple Type E, Type J, Type K, Type N, and Type T
- Spring-loaded and compact spring-loaded sensor mounting styles
- Hazardous location product approvals and certification
- Calibration services to give insight to sensor performance
- Calibration certificate to accompany sensor

Specification and selection of product materials, options, or components must be made by the purchaser of the equipment.

**Figure 1: Model Number Ordering Example**

Model				Sensor type		Sheath material		Sensor accuracy		Number of elements		Units	Sensor insertion length				Sensor mounting style		Options
2	1	4	C	R	W	S	M	A	1	S	4	E	0	1	5	0	S	L	WRS, ES...
1	2	3	4	5	6	7	8	9	10	11	12	13	14	15	16	17	18	19	XXXXX

The numbers below the model string example in [Figure 1](#) correlate to the character place numbers in the ordering table.

## Ensure sensor fits thermowell

Rosemount 114C Head length (H) + Immersion length (U) = Rosemount 214C Sensor insertion length (L).

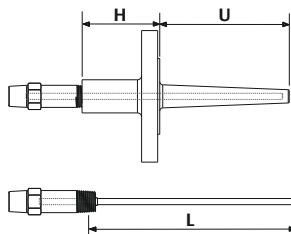

# RTD ordering information

**Table 1: Rosemount 214C RTD Quick Order Table**

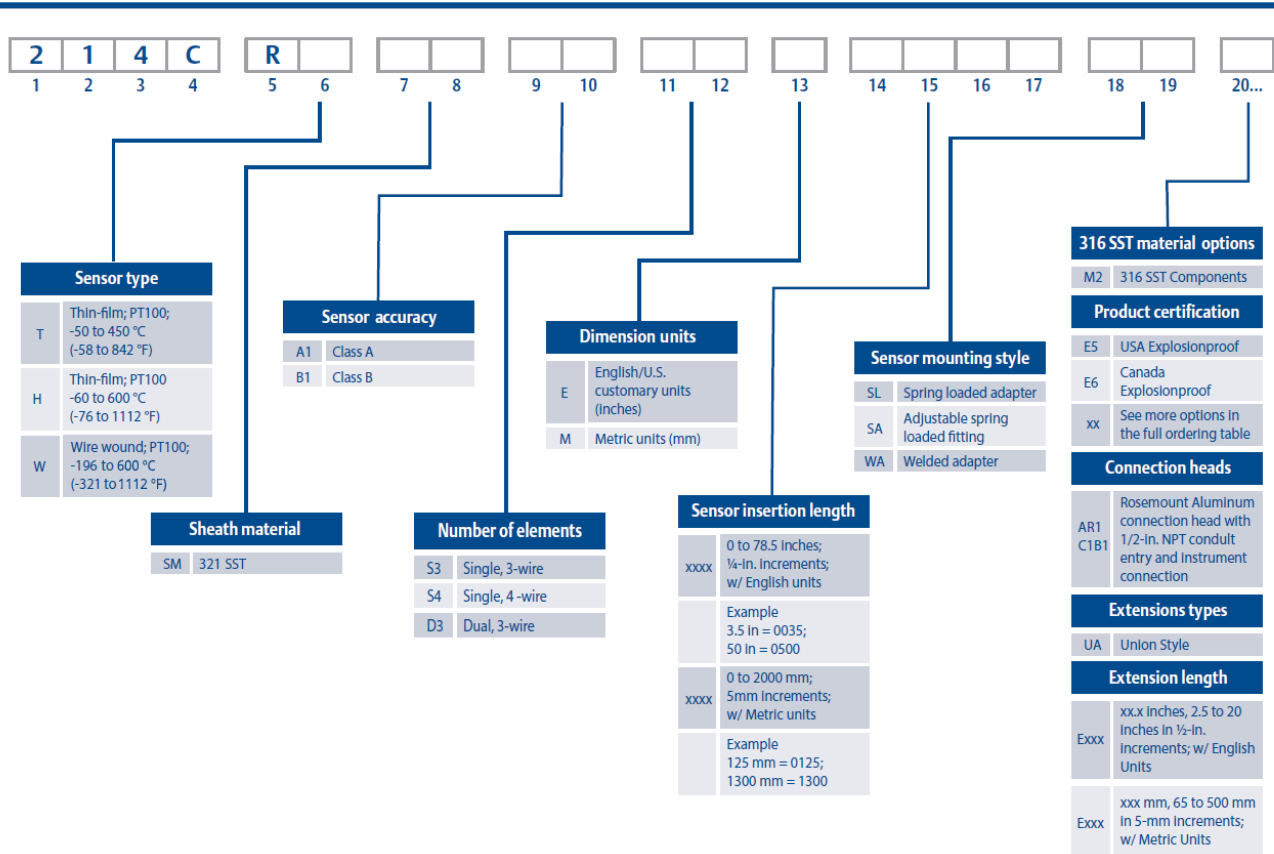

## Online product configurator

Many products are configurable online using our product configurator.

Select the **Configure** button or visit [Emerson.com/global](https://www.emerson.com/global) to start. With this tool's built-in logic and continuous validation, you can configure your products more quickly and accurately.

## Specifications and options

Specification and selection of product materials, options, and/or components must be made by the purchaser of the equipment.

## Optimizing lead time

The starred offerings (★) represent the most common options and should be selected for the fastest delivery times. The non-starred offerings are subject to additional delivery lead time.

## Required model components

### Model

Place #s 1-4		Description
★	214C	Temperature sensor core base model (made with standard outside diameter of ¼-in. [6 mm])

### Sensor type

Place #s 5-6	Description	Details	Ref. page
★	RT	RTD, PT100; $\alpha = -58$ to $842$ °F (0.00385; $-50$ to $450$ °C)	<a href="#">page 37</a>
★	RW	RTD, PT100; $\alpha = -321$ to $1112$ °F (0.00385; $-196$ to $600$ °C)	<a href="#">page 37</a>
★	RH	RTD, PT100; $\alpha = -76$ to $1112$ °F (0.00385; $-60$ to $600$ °C)	<a href="#">page 37</a>

#### Note

The sensor type temperature range is the full operating range of the sensor type and is not specific to the tolerance class or interchangeability.

### Sensor sheath material

Place #s 7-8	Description	Details	Ref. page
★	SM	321 SST	<a href="#">page 41</a>

### Sensor accuracy

Place #s 9-10	Description	Details	Image	Ref. page
★	A1	Class A accuracy is available with wire-wound element Option Code: RW over $-148$ to $842$ °F ( $-100$ to $450$ °C) and thin film element Option Code: RT over $32$ to $572$ °F ( $0$ to $300$ °C)		<a href="#">page 37</a>
★	B1			<a href="#">page 37</a>

**Number of elements**

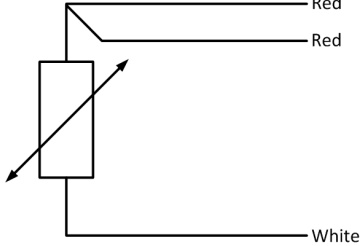
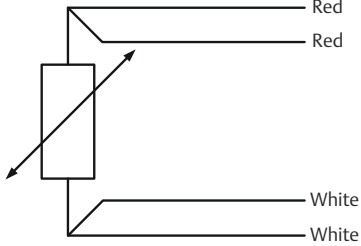
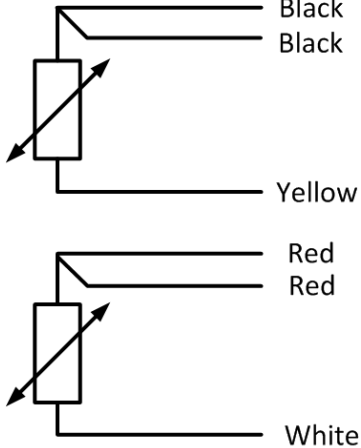
Place #s 11-12		Description	Details	Image	Ref. page
★	S3	Single, 3-wire	Good measurement results		<a href="#">page 43</a>
★	S4	Single, 4-wire	Excellent measurement results		<a href="#">page 43</a>
★	D3	Dual, 3-wire	Added measurement redundancy		<a href="#">page 43</a>

**Dimension units**

Place # 13	Description	Details	Ref. page
★	E	English/U.S. customary units (inches)	Only applies to lengths <a href="#">page 45</a>
★	M	Metric units (mm)	Only applies to lengths <a href="#">page 45</a>

### Sensor insertion length



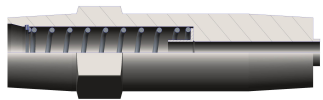
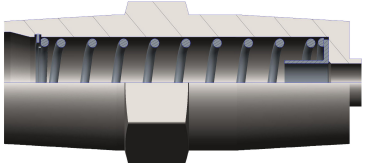
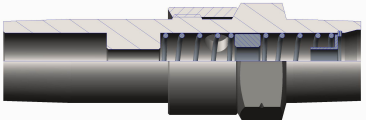
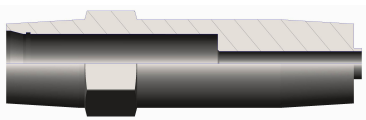
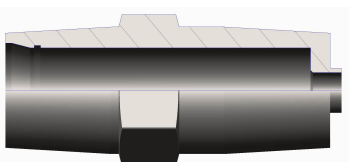
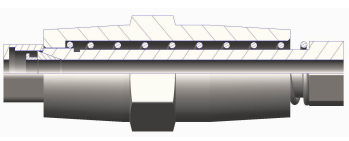

Place #s 14-17		Description	Ref. page
★	xxxx	xxx.x inches, 0 to 78.5 inches in ¼-in. increments (when ordered with Dimension units code E)	<a href="#">page 45</a>
		Example of a 6.25-in. length where the second decimal is dropped off: 0062	
★	xxxx	xxxx mm, 0 to 2000 mm in 1 mm increments (when ordered with Dimension units code M)	<a href="#">page 45</a>
		Example of a 50 mm length: 0050	

### Sensor mounting style

Welded adapters are built several millimeters shorter than specified length to ensure that the sheath will not be damaged by contact with the bottom of a thermowell if overtightened. Conversely, Spring-loaded adapters are built several millimeters longer than specified to ensure contact with the bottom of a thermowell.

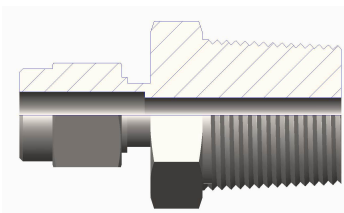
Place #s 18-19		Description	Details	Image	Ref. page
★	SL	Spring-loaded adapter	Ensures sensor contact with thermowell tip		<a href="#">page 47</a>
★	SC	Compact Spring-loaded adapter	Non-explosionproof adapter that is 1.17-in. (29.72 mm) shorter than standard Spring-loaded adapter (currently not available with Division 2/Zone 2 approvals)		<a href="#">page 48</a>
★	SW	Spring-loaded adapter with thermowell contact indication	Spring-loaded adapter with a small opening on the side of the adapter for visual indication of sensor contact with the tip of a thermowell		<a href="#">page 48</a>
★	WA	Welded adapter	Welded joint between sensor capsule and adapter allows for direct immersion of sensor into the process. If thermowell is used, this welded joint acts as a secondary process seal.		<a href="#">page 49</a>
★	WC	Compact-welded adapter	Non-explosionproof adapter that is 1.17-in. (29.72 mm) shorter than standard welded adapter (currently not available with Division 2/Zone 2 approvals)		<a href="#">page 49</a>
★	SA	Adjustable Spring-loaded fitting	Adjustable fitting that allows for installation along sensor capsule body. The Spring-loaded fitting ensures sensor contact to thermowell tip.		<a href="#">page 50</a>

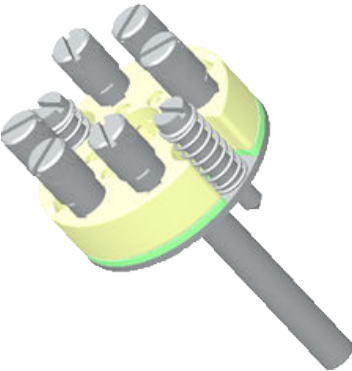

Place #s 18-19		Description	Details	Image	Ref. page
★	CA	Compression fitting 1/8-in. NPT	Adjustable fitting that allows for installation along the sensor capsule body. (100 psig maximum) (Default compression fitting material is stainless steel).		<a href="#">page 50</a>
★	CB	Compression fitting 1/4-in. NPT			
★	CC	Compression fitting 1/2-in. NPT			
★	CD	Compression fitting 3/4-in. NPT			
★	DF	DIN mounting plate with flying leads	Allows for assembly with headmount temperature transmitters and designed for easy mounting and replacement.		<a href="#">page 50</a>
★	DT	DIN mounting plate with terminal block	Allows for remote mounting assembly and designed for easy mounting and replacement.		<a href="#">page 50</a>
★	SO	Sensor only	Sensor capsule without any fittings or adapters for mounting		<a href="#">page 50</a>

## Additional options

### 316SST material options

Code		Description	Details	Image	Ref. page
★	M1	316 SST wire on tag	Changes out the original 304SST wire on tag to a corrosion-resistant 316SST wire on tag		<a href="#">page 51</a>
★	M2	316 SST components	Replaces various components with corrosion-resistant 316SST material (review reference page for affected components)		<a href="#">page 51</a>

### Product certification

Code		Description	Ref. page
★	E1	ATEX Flameproof	<a href="#">page 53</a>
★	I1	ATEX Intrinsic Safety	<a href="#">page 54</a>
★	N1	ATEX Zone 2	<a href="#">page 54</a>
★	ND	ATEX Dust Ignitionproof	<a href="#">page 54</a>
★	E2	Brazil Flameproof	<a href="#">page 56</a>
★	I2	Brazil Intrinsic Safety	<a href="#">page 57</a>
★	E3	China Flameproof	<a href="#">page 57</a>
★	I3	China Intrinsic Safety	<a href="#">page 58</a>
★	E4	Japan Flameproof	<a href="#">page 59</a>
★	E5	USA Explosionproof	<a href="#">page 52</a>
★	N5	USA Division 2	<a href="#">page 52</a>
★	E6	Canada Explosionproof	<a href="#">page 52</a>
★	N6	Canada Division 2	<a href="#">page 53</a>
★	E7	IECEX Flameproof	<a href="#">page 54</a>
★	I7	IECEX Intrinsic Safety	<a href="#">page 55</a>

Code		Description	Ref. page
★	N7	IECEX Zone 2	<a href="#">page 55</a>
★	NK	IECEX Dust Ignitionproof	<a href="#">page 55</a>
★	EM	Technical Regulations Customs Union (EAC) Flameproof	<a href="#">page 60</a>
★	IM	Technical Regulations Customs Union (EAC) Intrinsic Safety	<a href="#">page 60</a>
★	EP	Korea Flameproof	<a href="#">page 60</a>
★	IP	Korea Intrinsic Safety	<a href="#">page 60</a>
★	K1	Combination of ATEX Flameproof, Intrinsic Safety, Zone 2, and Dust Ignitionproof	<a href="#">page 61</a>
★	K3	Combination of China Flameproof, Intrinsic Safety, Zone 2, and Dust Ignitionproof	<a href="#">page 61</a>
★	K7	Combination of IECEX Flameproof, Intrinsic Safety, Zone 2, and Dust Ignitionproof	<a href="#">page 61</a>
★	KM	Combination of Technical Regulations Customs Union (EAC) Flameproof, Intrinsic Safety, and Dust Ignitionproof	<a href="#">page 61</a>
★	KP	Combination of Korea Flameproof, Intrinsic Safety, and Dust Ignitionproof	<a href="#">page 61</a>
★	KA	Combination of ATEX Flameproof and Canada Explosionproof	<a href="#">page 61</a>
★	KB	Combination of USA and Canada Explosionproof	<a href="#">page 61</a>
★	KC	Combination of ATEX Flameproof and USA Explosionproof	<a href="#">page 61</a>
★	KD	Combination of ATEX Flameproof, USA and Canada Explosionproof	<a href="#">page 61</a>
★	KE	Combination of ATEX and IECEX Flameproof, USA and Canada Explosionproof	<a href="#">page 61</a>
★	KN	Combination of ATEX and IECEX Zone 2, and USA and Canada Division 2	<a href="#">page 61</a>

### Connection heads

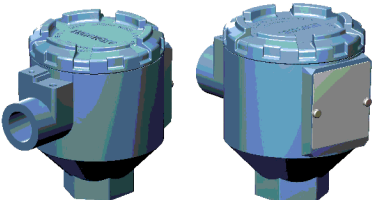
Code		Description	Details	Image	Ref. page
★	AR1	Rosemount aluminum	<ul style="list-style-type: none"> <li>▪ Conduit connection: ½-in. NPT; M20</li> <li>▪ Instrument connection: ½-in. NPT; M20; M24</li> <li>▪ Optional terminal block, stainless steel cover chain, external ground screw, or low temperature options also available</li> </ul>		<a href="#">page 62</a>

Code		Description	Details	Image	Ref. page
★	AR2	Rosemount aluminum with display cover	<ul style="list-style-type: none"> <li>Conduit connection: ½-in. NPT; M20</li> <li>Instrument connection: ½-in. NPT; M20; M24</li> <li>Optional terminal block, external ground screw, or low temperature options also available</li> </ul>		<a href="#">page 62</a>
★	SR1	Rosemount SST	<ul style="list-style-type: none"> <li>Conduit connection: ½-in. NPT; M20</li> <li>Instrument connection: ½-in. NPT; M20; M24</li> <li>Optional terminal block, stainless steel cover chain, external ground screw, or low temperature options also available</li> </ul>		<a href="#">page 62</a>
★	SR2	Rosemount SST with display cover	<ul style="list-style-type: none"> <li>Conduit connection: ½-in. NPT; M20</li> <li>Instrument connection: ½-in. NPT; M20; M24</li> <li>Optional terminal block, external ground screw, or low temperature options also available</li> </ul>		<a href="#">page 62</a>
★	AD1	Dual entry aluminum	<ul style="list-style-type: none"> <li>Conduit connections: ½-in. NPT, M20 x 1.5, or ¾-in. NPT</li> <li>Instrument connection: ½-in. NPT, M20 x 1.5, or M24</li> <li>Comes with cover chain.</li> </ul>		<a href="#">page 62</a>
★	SD1	Dual entry SST	<ul style="list-style-type: none"> <li>Conduit connection: ½-in. NPT, M20 x 1.5, or ¾-in. NPT</li> <li>Instrument connection: ½-in. NPT, M20 x 1.5, or M24</li> <li>Comes with cover chain.</li> </ul>		<a href="#">page 62</a>
★	AF1	BUZ aluminum	<ul style="list-style-type: none"> <li>Conduit connection: M20 x 1.5</li> <li>Instrument connection: ½-in. NPT or M24</li> </ul>		<a href="#">page 62</a>
★	AF3	BUZH aluminum	<ul style="list-style-type: none"> <li>Conduit connection: M20 x 1.5</li> <li>Instrument connection: ½-in. NPT or M24</li> </ul>		<a href="#">page 62</a>

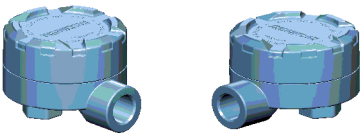
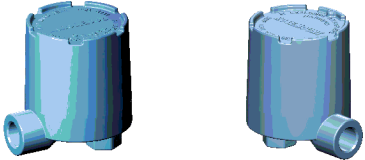
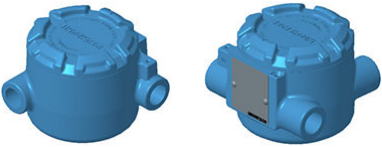
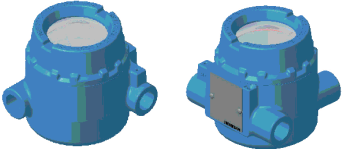
Code		Description	Details	Image	Ref. page
★	AT1 <sup>(1)</sup>	Aluminum with terminal strip	<ul style="list-style-type: none"> <li>Conduit connection: ¾-in. NPT</li> <li>Instrument connection: ½-in. NPT</li> <li>Optional stainless steel cover chain or external ground screw available</li> </ul>		<a href="#">page 62</a>
★	AT3 <sup>(1)</sup>	Aluminum with terminal strip and extended cover	<ul style="list-style-type: none"> <li>Conduit connection: ¾-in. NPT</li> <li>Instrument connection: ½-in. NPT</li> <li>Optional stainless steel cover chain or external ground screw available</li> </ul>		<a href="#">page 62</a>
★	AJ1	Universal 3 entry aluminum junction box	<ul style="list-style-type: none"> <li>Conduit connection: ½-in. NPT or M20</li> <li>Instrument connection: ½-in. NPT</li> <li>Optional terminal block, external ground screw, and stainless steel cover chain available</li> </ul>		<a href="#">page 62</a>
★	AJ2	Universal 3 entry aluminum junction box with display cover	<ul style="list-style-type: none"> <li>Conduit connection: ½-in. NPT or M20</li> <li>Instrument connection: ½-in. NPT</li> <li>Optional terminal block and external ground screw</li> </ul>		<a href="#">page 62</a>

(1) Requires the WD option from Lead wire extensions: Termination style.

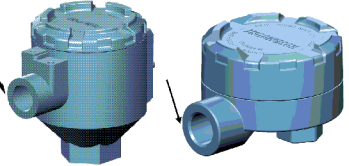

### Conduit entry thread type

Code	Description	Image	Ref. page
★	C1 ½-in. NPT		<a href="#">page 65</a>
★	C2 M20 x 1.5		<a href="#">page 65</a>
★	C3 ¾-in. NPT		<a href="#">page 65</a>

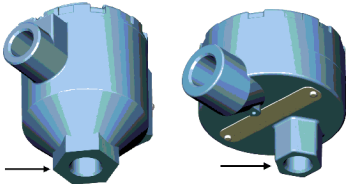

### Instrument connection thread type

Code	Description	Image	Ref. page
★	B1 ½-in. NPT		<a href="#">page 65</a>
	B2 M20 x 1.5		<a href="#">page 65</a>
	B4 M24 x 1.5		<a href="#">page 65</a>

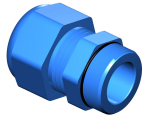
**Conduit cable glands**

Code		Description	Image	Ref. page
★	GN1	Ex d, standard cable diameter		<a href="#">page 66</a>
★	GN2	Ex d, thin cable diameter		<a href="#">page 66</a>
★	GN6	EMV, standard cable diameter		<a href="#">page 66</a>
★	GP1	Ex e, standard cable diameter, polyamide		<a href="#">page 66</a>
★	GP2	Ex e, thin cable diameter, polyamide		<a href="#">page 66</a>



**Extension type**

Code	Description	Details	Image		
★	UA	Union style, ½-in. NPT, ½-in. NPT	Contains union fitting, which allows orientation of the conduit entry during installation; also known as nipple-union style		<a href="#">page 67</a>
★	FA	Fixed style, ½-in. NPT, ½-in. NPT	Contains coupling fitting, which does not allow orientation of the conduit entry during installation; also known as nipple-coupling style		<a href="#">page 67</a>
	PD	DIN-style, 12 x 1.5, M24 x 1.5, M18 x 1.5	Contains one single piece assembly; also known as DIN-style extension		<a href="#">page 67</a>
	PE	DIN-style, 12 x 1.5, M24 x 1.5, M20 x 1.5			<a href="#">page 67</a>
	PH	DIN-style, 12 x 1.5, M24 x 1.5, M24 x 1.5			<a href="#">page 67</a>
	PK	DIN-style, 12 x 1.5, M24 x 1.5, G½-in. (BSPF)			<a href="#">page 67</a>
	PQ	DIN Style, 15 x 3, M24 x 1.5, M18 x 1.5			<a href="#">page 67</a>
	PT	DIN-style, 15 x 3, M24 x 1.5, M24 x 1.5			<a href="#">page 67</a>
	TC	DIN-style, 12 x 1.5, M24 x 1.5, ½-in. NPT			<a href="#">page 67</a>
	TD	DIN Style, 12 x 1.5, M24 x 1.5, ¾-in. NPT			<a href="#">page 67</a>
	TH	DIN-style, 12 x 1.5, M24 x 1.5, R ½-in. (BSPT)			<a href="#">page 67</a>
	TN	DIN Style, 15 x 3, M24 x 1.5, ½-in. NPT	<a href="#">page 67</a>		

**Extension length (E)**

Code		Description	Ref. page
★	Exxx	xx.x inches, 2.5 to 20 inches in ½-in. increments (when ordered with Dimension units code E)	<a href="#">page 68</a>
★	Exxx	xxx mm, 65 to 500 mm in 5 mm increments (when ordered with Dimension units code M)	<a href="#">page 68</a>

**Lead wire extension: Wire type**

Code		Description	Details	Image	Ref. page
	LA	Twisted lead wire extension	Allows addition of length to standard sensor wires.		<a href="#">page 70</a>
	LB	Shielded, PTFE wrapped cable lead wire extension	Standard sensor wires are braided to add rigidity, strength, and robustness. They are wrapped in PTFE as a chemical shield for added wire protection.		<a href="#">page 70</a>

**Lead wire extension: Wire length (T)**

Code		Description	Ref. page
	0018	18-in. (1.5 ft.) (when ordered with dimension units option "E")	<a href="#">page 70</a>
	0036	36-in. (3.0 ft.) (when ordered with dimension units option "E")	<a href="#">page 70</a>
	0072	72-in. (6.0 ft.) (when ordered with dimension units option "E")	<a href="#">page 70</a>
	0144	144-in. (12.0 ft.) (when ordered with dimension units option "E")	<a href="#">page 70</a>
	0288	288-in. (24 ft.) (when ordered with dimension units option "E")	<a href="#">page 70</a>
	0600	600-in. (50 ft.) (when ordered with dimension units option "E")	<a href="#">page 70</a>
	0900	900-in. (75 ft.) (when ordered with dimension units option "E")	<a href="#">page 70</a>
	1200	1200-in. (100 ft.) (when ordered with dimension units option "E")	<a href="#">page 70</a>
	xxxx	xxxx-in., 12 to 3600 inches in 1 inch increments (when ordered with dimension units option "E") Example of an 18-in. wire length: 0018	<a href="#">page 70</a>
	xxxx	xxxx cm, 30 to 9144 cm in 1 cm increments (when ordered with dimension units option "M") Example of a 50 cm wire length: 0050	<a href="#">page 70</a>

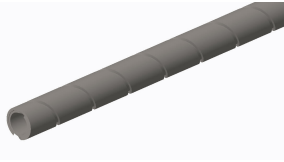
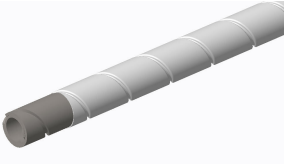
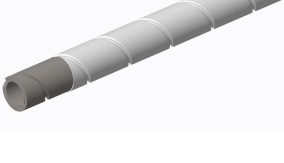

**Lead wire extension: Armor type**

Code		Description	Details	Image	Ref. page
	AN	Armored cable lead wire extension	Bare armored cable around wires to provide mechanical protection. There is no coating on the wires. Maximum length allowed is 1200 in. (3048 cm).		<a href="#">page 70</a>
	AC	PVC-coated armored cable lead wire extension	Armored cable around wires to provide mechanical protection. The armored cable is coated with Polyvinyl Chloride (PVC) coating. Maximum length allowed is 1200 in. (3048 cm).		<a href="#">page 70</a>
	AP	PTFE-coated armored cable lead wired extension	Armored cable around wires to provide mechanical protection. The armored cable is coated with Polytetrafluoroethylene (PTFE) coating. Maximum length allowed is 1200 in. (3048 cm).		<a href="#">page 70</a>

**Lead wire extension: Cable glands**

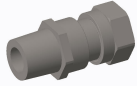
Code		Description	Image	Ref. page
	J1	½-in. NPT		<a href="#">page 71</a>
	J2	M20 x 1.5		<a href="#">page 71</a>

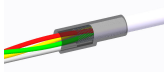

**Lead wire extension: Shielded cable drain wire**

Code		Description	Details	Image	Ref. page
	DW	Drain wire	Reduces resistance from ambient or electrical noise. It is only available with the shielded cable.		<a href="#">page 71</a>

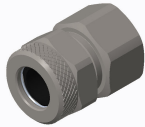
**Lead wire extension: Adapter-mounted cable gland**

Code		Description	Details	Image	Ref. page
	F1	Adapter-mounted cable gland, ½-in. NPT	Prevents process fluid from exiting a non sealed adapter (ex. Spring-loaded adapter).		<a href="#">page 71</a>

### Lead wire extension: Termination style

Code		Description	Details	Image	Ref. page
	WB	Spade lugs	Terminals allow for ease of wiring.		<a href="#">page 72</a>
	WD	Bootlace ferrules	Ferrules provide ease in wiring and give better electrical contact where needed.		<a href="#">page 72</a>

### Temperature calibration

Code		Description	Ref. page
★	V20Q4	32 to 212 °F (0 to 100 °C)	<a href="#">page 74</a>
★	V21Q4	32 to 392 °F (0 to 200 °C)	<a href="#">page 74</a>
★	V22Q4	32 to 842 °F (0 to 450 °C)	<a href="#">page 74</a>
★	V23Q4	32 to 1112 °F (0 to 600 °C)	<a href="#">page 74</a>
★	V24Q4	-58 to 212 °F (-50 to 100 °C)	<a href="#">page 74</a>
★	V25Q4	-58 to 392 °F (-50 to 200 °C)	<a href="#">page 74</a>
★	V26Q4	-58 to 842 °F (-50 to 450 °C)	<a href="#">page 74</a>
★	V27Q4	-321 to 1112 °F (-196 to 600 °C)	<a href="#">page 74</a>

### Temperature range calibration

Code		Description	Ref. page
★	X8Q4	Custom specified temperature range	<a href="#">page 75</a>

### Single-point calibration

Code		Description	Ref. page
★	X91Q4	Resistance of one specified temperature point	<a href="#">page 73</a>

## MID Custody Transfer Calibration

Code		Description	Ref. page
	MD1	MID Custody Transfer Calibration, -196 °C to 0 °C	<a href="#">page 75</a>
	MD2	MID Custody Transfer Calibration, -50 °C to 100 °C	<a href="#">page 75</a>
	MD3	MID Custody Transfer Calibration, 50 °C to 200 °C	<a href="#">page 75</a>



## PAC Calibration Certificate

Code		Description	Ref. page
	QG	Calibration Certificate and PAC Verification Certificate	<a href="#">page 75</a>

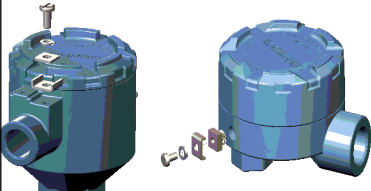
## Ground screw

Code		Description	Details	Image	Ref. page
★	G1	External ground screw	Allows for grounding of wires to the connection head		<a href="#">page 75</a>

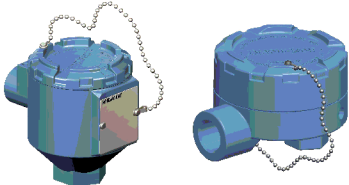
## Cover chain

Code		Description	Details	Image	Ref. page
★	G3	Cover chain	Keeps the cover connected to the connection head when disassembled; not available with display covers		<a href="#">page 76</a>
★	G6	Extension ring	Aluminium Extension Ring for Dua Transmitter Mounting		<a href="#">page 76</a>

**Terminal block**

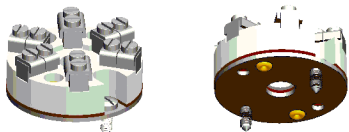
Code		Description	Details	Images	Ref. page
★	TB	Terminal block	Available if wire termination in a connection head is required		<a href="#">page 78</a>

## Low temperature housing

Code		Description	Ref. page
★	LT	Low temperature connection head option down to -60 °F (-51 °C)	<a href="#">page 78</a>
	BR	-76 °F (-60 °C) cold temperature operation	<a href="#">page 78</a>

## Product certifications

Rev 2.23

### European Directive information

A copy of the EU Declaration of Conformity can be found at the end of the Quick Start Guide. The most recent revision of the EU Declaration of Conformity can be found at [Emerson.com/Rosemount](https://www.emerson.com/Rosemount).

### Ordinary Location Certification

The Rosemount 214C has been examined and tested to determine that the design meets the basic electrical, mechanical, and fire protection requirements by a nationally recognized test laboratory (NRTL) as accredited by the Federal Occupational Safety and Health Administration (OSHA).

### Note

The terminal strip in the Aluminum with Terminal Strip (AT1 or AT3) connection head requires sensor lead wires to have a wire termination (Ex: Bootlace ferrule or spade lug).

### North America

The US National Electrical Code® (NEC) and the Canadian Electrical Code (CEC) permit the use of Division marked equipment in Zones and Zone marked equipment in Divisions. The markings must be suitable for the area classification, gas, and temperature class. This information is clearly defined in the respective codes.

## Thermowell assembled to sensor

Code		Description	Details	Ref. page
★	XW	Process-ready assembly of sensor and thermowell	Ensures sensor is threaded into thermowell and torqued for process-ready installation	<a href="#">page 79</a>
★	XT	Hand-tight assembly of sensor and thermowell	Ensures sensor is threaded into thermowell but only hand tightened	<a href="#">page 79</a>

## Extended product warranty

Code		Description	Details	Ref. page
★	WR3	3-year limited warranty	This warranty option is to extend your manufacturers warranty to three or five years for manufacturer related defects	<a href="#">page 79</a>
★	WR5	5-year limited warranty		<a href="#">page 79</a>

# Thermocouple ordering information

**Table 2: Rosemount 214C Thermocouple Quick Order Table**

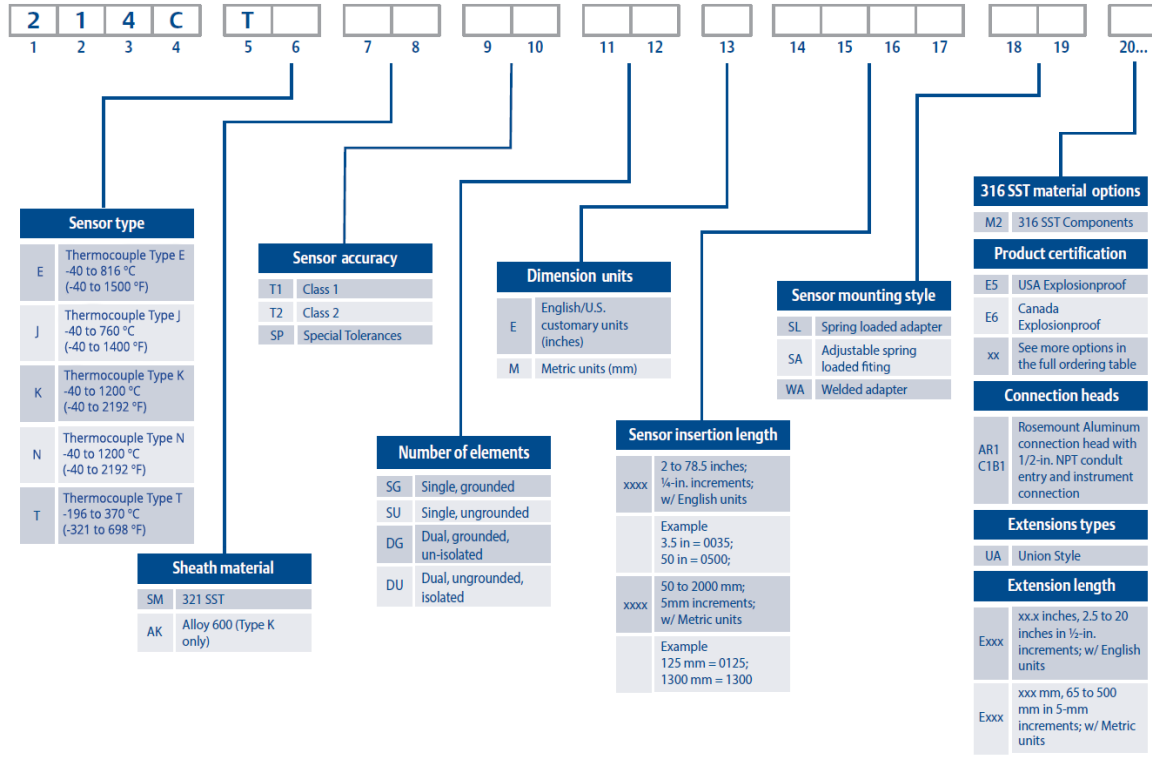

## Online product configurator

Many products are configurable online using our product configurator.

Select the **Configure** button or visit [Emerson.com/global](https://www.emerson.com/global) to start. With this tool's built-in logic and continuous validation, you can configure your products more quickly and accurately.

## Specifications and options

Specification and selection of product materials, options, and/or components must be made by the purchaser of the equipment.

## Optimizing lead time

The starred offerings (★) represent the most common options and should be selected for the fastest delivery times. The non-starred offerings are subject to additional delivery lead time.

## Required model components

### Model

Place #s 1-4		Description
★	214C	Temperature thermocouple sensor core base model (made with standard outside diameter of 6 mm [ $\frac{1}{4}$ -in.])

### Sensor type

Place #s 5-6		Description	Details	Ref. page
★	TE	Thermocouple Type E, -40 to 1500 °F (-40 to 816 °C)	It is non-magnetic and has the highest output voltage vs. temperature change of any standard thermocouple type.	40
★	TJ	Thermocouple Type J, -40 to 1400 °F (-40 to 760 °C)	One of the most common thermocouples made of conductor materials iron and constantan.	40
★	TK	Thermocouple Type K, -40 to 2192 °F (-40 to 1200 °C)	Commonly used for high temperature applications, Type K thermocouples contain Chromel® and Alumel® conductors (available with sheath material Option AK only).	41
★	TN	Thermocouple Type N, -40 to 2192 °F (-40 to 1200 °C)	Achieves considerably higher thermoelectric stability than the base-metal types E, J, K and T thermocouples.	41
★	TT	Thermocouple Type T, -321 to 698 °F (-196 to 370 °C)	Commonly used for low temperature applications, Type T thermocouples contain copper and constantan conductors.	41

### Sensor sheath material

Place #s 7-8		Description	Details	Ref. page
★	SM	321 SST	Maximum operating temperature limit of 1500 °F (816 °C) (For types TE, TJ and TT only.)	<a href="#">page 41</a>
★	AK	Alloy 600	Maximum operating temperature limit of 2192 °F (1200 °C) (For type TK and TN only.)	<a href="#">page 41</a>

### Sensor accuracy

Place #s 9-10		Description	Details	Ref. Page
★	T1	Class 1 per IEC 60584	Approximately half of accuracy error margin than Class 2; made with higher grade wire, which increases accuracy reading	<a href="#">page 42</a>
★	T2	Class 2 per IEC 60584	Wider accuracy error margin than Class 1; made with standard thermocouple grade wire	<a href="#">page 42</a>
★	SP	Special Tolerances per ASTM E230	Approximately half of accuracy error margin than Standard Tolerances; made with higher grade wire, which increases the accuracy reading	<a href="#">page 42</a>
★	ST	Standard Tolerances per ASTM E230	Wider accuracy error margin than Special Tolerances; made with standard thermocouple grade wire	<a href="#">page 42</a>

### Numbers of elements

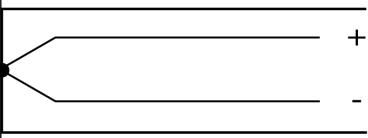
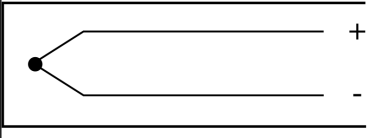
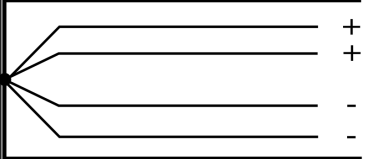
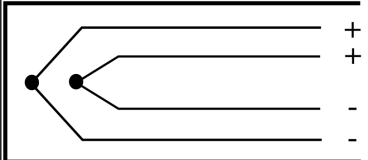
Number #s 11-12		Description	Details	Image	Ref. page
★	SG	Single, grounded	Provides contact to sheath for faster response time than a single, ungrounded thermocouple; more susceptible to induced noise from ground loops		<a href="#">page 43</a>
★	SU	Single, ungrounded	Provides more accurate reading than a single grounded thermocouple, with a slower response time		<a href="#">page 43</a>
★	DG	Dual, grounded, unisolated	Provides faster response time than a dual ungrounded isolated thermocouple with added redundancy in the reading		<a href="#">page 43</a>
★	DU	Dual, ungrounded, isolated	Provides more accurate reading than a dual grounded unisolated thermocouple, with a slower response time		<a href="#">page 43</a>

### Dimension units

Place # 13	Description	Details	Ref. page
★	E	English/U.S. customary units (inches)	Only applies to lengths <a href="#">page 45</a>
★	M	Metric units (mm)	Only applies to lengths <a href="#">page 45</a>

### Sensor insertion length



Place #s 14-17	Description	Ref. page
★	xxxx xxx.x inches, 0 to 78.5 inches in ¼-in. increments (when ordered with Dimension units code E) Example of a 6.25-in. length where the second decimal is dropped off: 0062	<a href="#">page 45</a>
★	xxxx xxxx mm, 0 to 2000 mm in 1 mm increments (when ordered with Dimension units code M) Example of a 50 mm length: 0050	<a href="#">page 45</a>

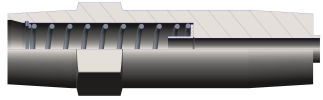
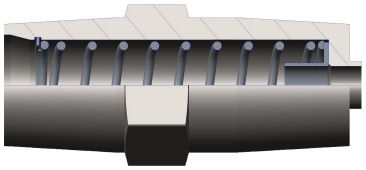
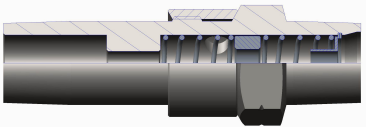
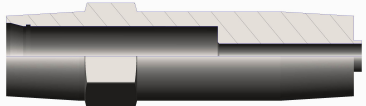
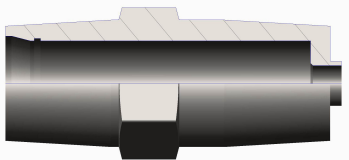
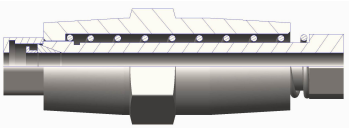
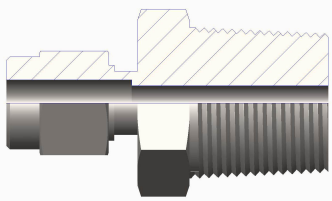

### Sensor mounting style

Welded adapters are built several millimeters shorter than specified length to ensure that the sheath will not be damaged by contact with the bottom of a thermowell if overtightened. Conversely, spring loaded adapters are built several millimeters longer than specified to ensure contact with the bottom of a thermowell.

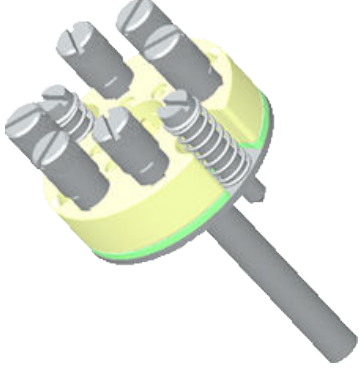
Place #s 18-19	Description	Details	Image	Ref. page
★ SL	Spring-loaded adapter	Ensures sensor contact with thermowell tip		<a href="#">page 47</a>
★ SC	Compact spring-loaded adapter	Non-explosionproof adapter that is 1.17-in. (29.72 mm) shorter than standard spring-loaded adapter (currently not available with Division 2/Zone 2 approvals)		<a href="#">page 48</a>
★ SW	Spring-loaded adapter with thermowell contact indication	Spring-loaded adapter with a small opening on the side of the adapter for visual indication of sensor contact with the tip of a thermowell		<a href="#">page 48</a>
★ WA	Welded adapter	Welded joint between sensor capsule and adapter allows for direct immersion of sensor into the process. If thermowell is used, this welded joint acts as a secondary process seal.		<a href="#">page 49</a>
★ WC	Compact-welded adapter	Non-explosionproof adapter that is 1.17-in. (29.72 mm) shorter than standard welded adapter (currently not available with Division 2/Zone 2 approvals)		<a href="#">page 49</a>
★ SA	Adjustable spring loaded fitting	Adjustable fitting that allows for installation along sensor capsule body. The spring loaded fitting ensures sensor contact to thermowell tip.		<a href="#">page 50</a>
★ CA	Compression fitting 1/8-in. NPT	Adjustable fitting that allows for installation along the sensor capsule body. (100 psig maximum.) (Default compression fitting material is stainless steel.)		<a href="#">page 50</a>
★ CB	Compression fitting 1/4-in. NPT			
★ CC	Compression fitting 1/2-in. NPT			
★ CD	Compression fitting 3/4-in. NPT			

Place #s 18-19		Description	Details	Image	Ref. page
★	DF	DIN mounting plate with flying leads	Allows for assembly with headmount temperature transmitters and designed for easy mounting and replacement.		<a href="#">page 50</a>
★	DT	DIN mounting plate with terminal block	Allows for remote mounting assembly and designed for easy mounting and replacement.		<a href="#">page 50</a>
★	SO	Sensor only	Sensor capsule without any fittings or adapters for mounting		<a href="#">page 50</a>

## Additional options

### 316SST material options

Code	Description	Details	Image	Ref. page
★ M1	316 SST wire on tag	Changes out the original 304SST wire on tag to a corrosion-resistant 316SST wire on tag		<a href="#">page 51</a>
★ M2	316 SST components	Replaces various components with corrosion-resistant 316SST material (review reference page for affected components)		<a href="#">page 51</a>



## Product certification

Code		Description	Ref. page
★	E1	ATEX Flameproof	<a href="#">page 53</a>
★	I1	ATEX Intrinsic Safety	<a href="#">page 54</a>
★	N1	ATEX Zone 2	<a href="#">page 54</a>
★	ND	ATEX Dust Ignitionproof	<a href="#">page 54</a>
★	E2	Brazil Flameproof	<a href="#">page 56</a>
★	I2	Brazil Intrinsic Safety	<a href="#">page 57</a>
★	E3	China Flameproof	<a href="#">page 57</a>
★	I3	China Intrinsic Safety	<a href="#">page 58</a>
★	E4	Japan Flameproof	<a href="#">page 59</a>
★	E5	USA Explosionproof	<a href="#">page 52</a>
★	N5	USA Division 2	<a href="#">page 52</a>
★	E6	Canada Explosionproof	<a href="#">page 52</a>
★	N6	Canada Division 2	<a href="#">page 53</a>
★	E7	IECEX Flameproof	<a href="#">page 54</a>
★	I7	IECEX Intrinsic Safety	<a href="#">page 55</a>
★	N7	IECEX Zone 2	<a href="#">page 55</a>
★	NK	IECEX Dust Ignitionproof	<a href="#">page 55</a>
★	EM	Technical Regulations Customs Union (EAC) Flameproof	<a href="#">page 60</a>
★	IM	Technical Regulations Customs Union (EAC) Intrinsic Safety	<a href="#">page 60</a>
★	EP	Korea Flameproof	<a href="#">page 60</a>
★	IP	Korea Intrinsic Safety	<a href="#">page 60</a>
★	K1	Combination of ATEX Flameproof, Intrinsic Safety, Zone 2, and Dust Ignitionproof	<a href="#">page 61</a>
★	K3	Combination of China Flameproof, Intrinsic Safety, Zone 2, and Dust Ignitionproof	<a href="#">page 61</a>

Code		Description	Ref. page
★	K7	Combination of IECEx Flameproof, Intrinsic Safety, Zone 2, and Dust Ignitionproof	<a href="#">page 61</a>
★	KM	Combination of Technical Regulations Customs Union (EAC) Flameproof, Intrinsic Safety, and Dust Ignitionproof	<a href="#">page 61</a>
★	KP	Combination of Korea Flameproof, Intrinsic Safety, and Dust Ignitionproof	<a href="#">page 61</a>
★	KA	Combination of ATEX Flameproof and Canada Explosionproof	<a href="#">page 61</a>
★	KB	Combination of USA and Canada Explosionproof	<a href="#">page 61</a>
★	KC	Combination of ATEX Flameproof and USA Explosionproof	<a href="#">page 61</a>
★	KD	Combination of ATEX Flameproof, USA and Canada Explosionproof	<a href="#">page 61</a>
★	KE	Combination of ATEX and IECEx Flameproof, USA and Canada Explosionproof	<a href="#">page 61</a>
★	KN	Combination of ATEX and IECEx Zone 2, and USA and Canada Division 2	<a href="#">page 61</a>

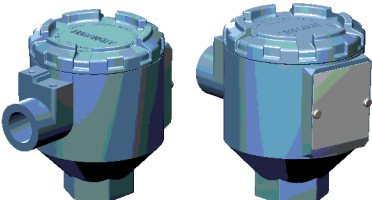
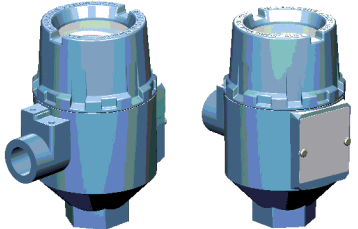
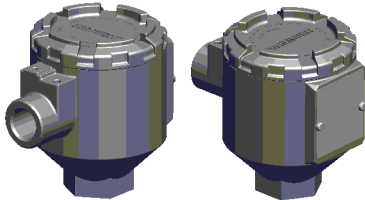
**Connection heads**

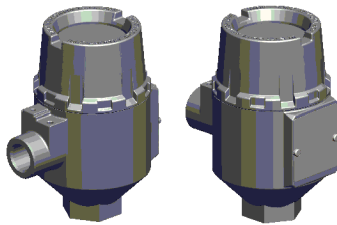
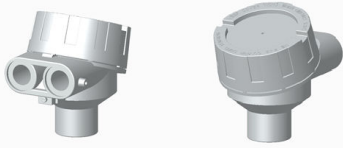
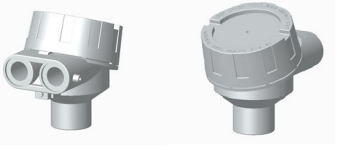
Code		Description	Details	Image	Ref. page
★	AR1	Rosemount aluminum	<ul style="list-style-type: none"> <li>Conduit connection: ½-in. NPT; M20</li> <li>Instrument connection: ½-in. NPT; M20; M24</li> <li>Optional terminal block, stainless steel cover chain, external ground screw, or low temperature options also available</li> </ul>		<a href="#">page 62</a>
★	AR2	Rosemount aluminum with display cover	<ul style="list-style-type: none"> <li>Conduit connection: ½-in. NPT; M20</li> <li>Instrument connection: ½-in. NPT; M20; M24</li> <li>Optional terminal block, external ground screw, or low temperature options also available</li> </ul>		<a href="#">page 62</a>
★	SR1	Rosemount SST	<ul style="list-style-type: none"> <li>Conduit connection: ½-in. NPT; M20</li> <li>Instrument connection: ½-in. NPT; M20; M24</li> <li>Optional terminal block, stainless steel cover chain, external ground screw, or low temperature options also available</li> </ul>		<a href="#">page 62</a>

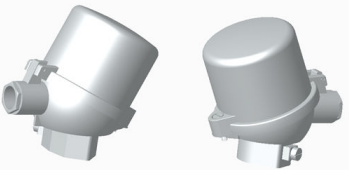
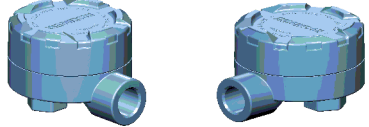
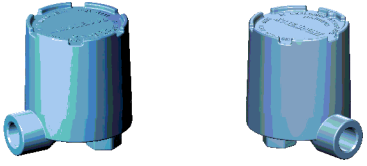
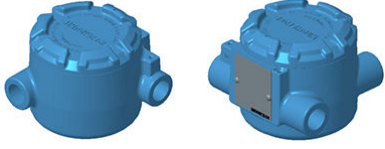
Code		Description	Details	Image	Ref. page
★	SR2	Rosemount SST with display cover	<ul style="list-style-type: none"> <li>Conduit connection: ½-in. NPT; M20</li> <li>Instrument connection: ½-in. NPT; M20; M24</li> <li>Optional terminal block, external ground screw, or low temperature options also available</li> </ul>		<a href="#">page 62</a>
★	AD1	Dual entry aluminum	<ul style="list-style-type: none"> <li>Conduit connections: ½-in. NPT, M20 x 1.5, or ¾-in. NPT</li> <li>Instrument connection: ½-in. NPT, M20 x 1.5, or M24</li> <li>Comes with cover chain.</li> </ul>		<a href="#">page 62</a>
★	SD1	Dual entry SST	<ul style="list-style-type: none"> <li>Conduit connection: ½-in. NPT, M20 x 1.5, or ¾-in. NPT</li> <li>Instrument connection: ½-in. NPT, M20 x 1.5, or M24</li> <li>Comes with cover chain.</li> </ul>		<a href="#">page 62</a>
★	AF1	BUZ aluminum	<ul style="list-style-type: none"> <li>Conduit connection: M20 x 1.5</li> <li>Instrument connection: ½-in. NPT or M24</li> </ul>		<a href="#">page 62</a>
★	AF3	BUZH aluminum	<ul style="list-style-type: none"> <li>Conduit connection: M20 x 1.5</li> <li>Instrument connection: ½-in. NPT or M24</li> </ul>		<a href="#">page 62</a>
★	AT1 <sup>(1)</sup>	Aluminum with terminal strip	<ul style="list-style-type: none"> <li>Conduit connection: ¾-in. NPT</li> <li>Instrument connection: ½-in. NPT</li> <li>Optional stainless steel cover chain or external ground screw available</li> </ul>		<a href="#">page 62</a>
★	AT3 <sup>(1)</sup>	Aluminum with terminal strip and extended cover	<ul style="list-style-type: none"> <li>Conduit connection: ¾-in. NPT</li> <li>Instrument connection: ½-in. NPT</li> <li>Optional stainless steel cover chain or external ground screw available</li> </ul>		<a href="#">page 62</a>
★	AJ1	Universal 3 entry aluminum junction box	<ul style="list-style-type: none"> <li>Conduit connection: ½-in. NPT or M20</li> <li>Instrument connection: ½-in. NPT</li> <li>Optional terminal block, external ground screw, and stainless steel cover chain available</li> </ul>		<a href="#">page 62</a>

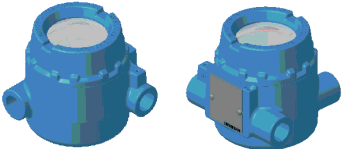
Code		Description	Details	Image	Ref. page
★	AJ2	Universal 3 entry aluminum junction box with display cover	<ul style="list-style-type: none"> <li>Conduit connection: ½-in. NPT or M20</li> <li>Instrument connection: ½-in. NPT</li> <li>Optional terminal block and external ground screw</li> </ul>		<a href="#">page 62</a>

(1) Requires the WD option from Lead wire extensions: Termination style.

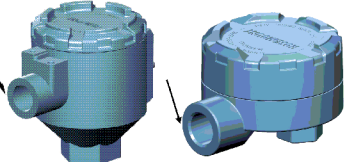

### Conduit entry thread type

Code		Description	Image	Ref. page
★	C1	½-in. NPT		<a href="#">page 65</a>
★	C2	M20 x 1.5		<a href="#">page 65</a>
★	C3	¾-in. NPT		<a href="#">page 65</a>

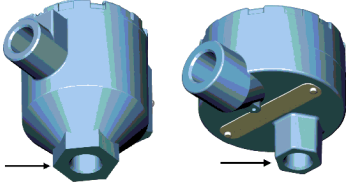

### Instrument connection thread type

Code		Description	Image	Ref. page
★	B1	½-in. NPT		<a href="#">page 65</a>
	B2	M20 x 1.5		<a href="#">page 65</a>
	B4	M24 x 1.5		<a href="#">page 65</a>

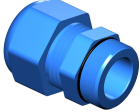
### Conduit cable glands

Code		Description	Image	Ref. page
★	GN1	Ex d, standard cable diameter		<a href="#">page 66</a>
★	GN2	Ex d, thin cable diameter		<a href="#">page 66</a>
★	GN6	EMV, standard cable diameter		<a href="#">page 66</a>
★	GP1	Ex e, standard cable diameter, polyamide		<a href="#">page 66</a>
★	GP2	Ex e, thin cable diameter, polyamide		<a href="#">page 66</a>

### Extension type

Code		Description	Details	Image	
★	UA	Union style, ½-in. NPT, ½-in. NPT	Contains union fitting, which allows orientation of the conduit entry during installation; also known as nipple-union style		<a href="#">page 67</a>
★	FA	Fixed style, ½-in. NPT, ½-in. NPT	Contains coupling fitting, which does not allow orientation of the conduit entry during installation; also known as nipple-coupling style		<a href="#">page 67</a>
	PD	DIN-style, 12 x 1.5, M24 x 1.5, M18 x 1.5	Contains one single piece assembly; also known as DIN-style extension		<a href="#">page 67</a>
	PE	DIN-style, 12 x 1.5, M24 x 1.5, M20 x 1.5			<a href="#">page 67</a>
	PH	DIN-style, 12 x 1.5, M24 x 1.5, M24 x 1.5			<a href="#">page 67</a>
	PK	DIN-style, 12 x 1.5, M24 x 1.5, G½-in. (BSPF)			<a href="#">page 67</a>
	PQ	DIN Style, 15 x 3, M24 x 1.5, M18 x 1.5			<a href="#">page 67</a>
	PT	DIN-style, 15 x 3, M24 x 1.5, M24 x 1.5			<a href="#">page 67</a>
	TC	DIN-style, 12 x 1.5, M24 x 1.5, ½-in. NPT			<a href="#">page 67</a>
	TD	DIN Style, 12 x 1.5, M24 x 1.5, ¾-in. NPT			<a href="#">page 67</a>
	TH	DIN-style, 12 x 1.5, M24 x 1.5, R ½-in. (BSPT)			<a href="#">page 67</a>
	TN	DIN Style, 15 x 3, M24 x 1.5, ½-in. NPT			<a href="#">page 67</a>

### Extension length (E)

Code	Description	Ref. page
★	Exxx xx.x inches, 2.5 to 20 inches in ½-in. increments (when ordered with Dimension units code E)	<a href="#">page 68</a>
★	Exxx xxx mm, 65 to 500 mm in 5 mm increments (when ordered with Dimension units code M)	<a href="#">page 68</a>

### Lead wire extension: Wire type

Code	Description	Details	Image	Ref. page
LA	Twisted lead wire extension	Allows addition of length to standard sensor wires.		<a href="#">page 70</a>

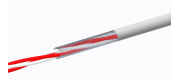
Code	Description	Details	Image	Ref. page
LB	Shielded, PTFE wrapped cable lead wire extension	Standard sensor wires are braided to add rigidity, strength, and robustness. They are wrapped in PTFE as a chemical shield for added wire protection.		<a href="#">page 70</a>

**Lead wire extension: Wire length (T)**

Code	Description	Ref. page
0018	18-in. (1.5 ft.) (when ordered with dimension units option "E")	<a href="#">page 70</a>
0036	36-in. (3.0 ft.) (when ordered with dimension units option "E")	<a href="#">page 70</a>
0072	72-in. (6.0 ft.) (when ordered with dimension units option "E")	<a href="#">page 70</a>
0144	144-in. (12.0 ft.) (when ordered with dimension units option "E")	<a href="#">page 70</a>
0288	288-in. (24 ft.) (when ordered with dimension units option "E")	<a href="#">page 70</a>
0600	600-in. (50 ft.) (when ordered with dimension units option "E")	<a href="#">page 70</a>
0900	900-in. (75 ft.) (when ordered with dimension units option "E")	<a href="#">page 70</a>
1200	1200-in. (100 ft.) (when ordered with dimension units option "E")	<a href="#">page 70</a>
xxxx	xxxx-in., 12 to 3600 inches in 1 inch increments (when ordered with dimension units option "E") Example of an 18-in. wire length: 0018	<a href="#">page 70</a>
xxxx	xxxx cm, 30 to 9144 cm in 1 cm increments (when ordered with dimension units option "M") Example of a 50 cm wire length: 0050	<a href="#">page 70</a>

**Lead wire extension: Armor type**

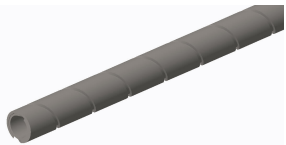
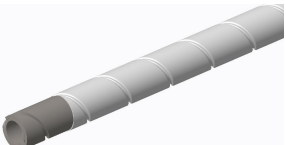
Code	Description	Details	Image	Ref. page
AN	Armored cable lead wire extension	Bare armored cable around wires to provide mechanical protection. There is no coating on the wires. Maximum length allowed is 1200 in. (3048 cm).		<a href="#">page 70</a>
AC	PVC-coated armored cable lead wire extension	Armored cable around wires to provide mechanical protection. The armored cable is coated with Polyvinyl Chloride (PVC) coating. Maximum length allowed is 1200 in. (3048 cm).		<a href="#">page 70</a>



Code		Description	Details	Image	Ref. page
	AP	PTFE-coated armored cable lead wired extension	Armored cable around wires to provide mechanical protection. The armored cable is coated with Polytetrafluoroethylene (PTFE) coating. Maximum length allowed is 1200 in. (3048 cm).		<a href="#">page 70</a>

**Lead wire extension: Cable glands**

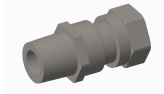
Code		Description	Image	Ref. page
	J1	½-in. NPT		<a href="#">page 71</a>
	J2	M20 x 1.5		<a href="#">page 71</a>

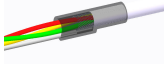

**Lead wire extension: Shielded cable drain wire**

Code		Description	Details	Image	Ref. page
	DW	Drain wire	Reduces resistance from ambient or electrical noise. It is only available with the shielded cable.		<a href="#">page 71</a>

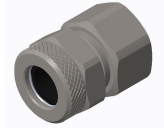
**Lead wire extension: Adapter-mounted cable gland**

Code		Description	Details	Image	Ref. page
	F1	Adapter-mounted cable gland, ½-in. NPT	Prevents process fluid from exiting a non sealed adapter (ex. Spring-loaded adapter).		<a href="#">page 71</a>



**Lead wire extension: Termination style**

Code		Description	Details	Image	Ref. page
	WB	Spade lugs	Terminals allow for ease of wiring.		<a href="#">page 72</a>
	WD	Bootlace ferrules	Ferrules provide ease in wiring and give better electrical contact where needed.		<a href="#">page 72</a>

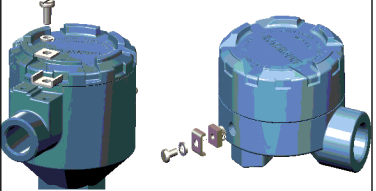
**Ground screw**

Code		Description	Details	Image	Ref. page
★	G1	External ground screw	Allows for grounding of wires to the connection head		<a href="#">page 75</a>

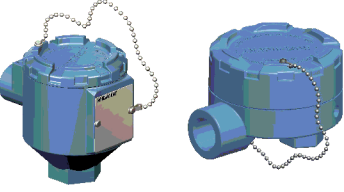
**Cover chain**

Code		Description	Details	Image	Ref. page
★	G3	Cover chain	Keeps the cover connected to the connection head when disassembled; not available with display covers		<a href="#">page 76</a>
★	G6	Extension ring	Aluminium Extension Ring for Dua Transmitter Mounting		<a href="#">page 76</a>

**Terminal block**

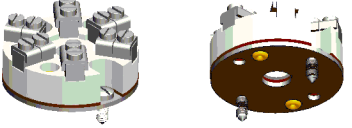
Code		Description	Details	Images	Ref. page
★	TB	Terminal block	Available if wire termination in a connection head is required		<a href="#">page 78</a>

**Low temperature housing**

Code		Description	Ref. page
★	LT	Low temperature connection head option down to -60 °F (-51 °C)	<a href="#">page 78</a>

Code		Description	Ref. page
	BR	-76 °F (-60 °C) cold temperature operation	<a href="#">page 78</a>

### Transmitter assembled to sensor

Code		Description	Details	Ref. page
★	XA	Process-ready assembly of transmitter and sensor	Ensures sensor is threaded into connection head with transmitter and torqued for process-ready installation; sensor is wired to the transmitter	<a href="#">page 78</a>
★	XC	Hand-tight assembly of transmitter and sensor	Ensures sensor is threaded into connection head with transmitter but only hand tightened; manual wiring is required	<a href="#">page 78</a>

### Thermowell assembled to sensor

Code		Description	Details	Ref. page
★	XW	Process-ready assembly of sensor and thermowell	Ensures sensor is threaded into thermowell and torqued for process-ready installation	<a href="#">page 79</a>
★	XT	Hand-tight assembly of sensor and thermowell	Ensures sensor is threaded into thermowell but only hand tightened	<a href="#">page 79</a>

### Extended product warranty

Code		Description	Details	Ref. page
★	WR3	3-year limited warranty	This warranty option is to extend your manufacturers warranty to three or five years for manufacturer related defects	<a href="#">page 79</a>
★	WR5	5-year limited warranty		<a href="#">page 79</a>

# Ordering information detail

## Sensor type

Back to [RTD ordering information](#).

### RTD

RTDs are based on the principle that the electrical resistance of a metal increases as temperature increases – a phenomenon known as thermal resistivity. Thus, a temperature measurement can be inferred by measuring the resistance of the RTD element.

RTDs are constructed of a resistive material with leads attached and usually placed into a protective sheath (see [Sheath material](#) for details). The resistive material can be a variety of materials. Emerson however, standardizes on platinum materials for all RTDs because of its high accuracy, excellent repeatability, and exceptional linearity over a wide temperature range. Platinum RTDs also exhibit a large resistance change per degree of temperature change.

The relationship between the resistance change of an RTD vs. temperature is called its Temperature Coefficient of Resistance (TCR) and is often referred to as the RTD's alpha curve. Emerson's PT100 RTDs all have a standard alpha coefficient of  $\alpha = 0.00385$  which is the most popular option that is recognized nationally and internationally. Reference [Figure 2](#) for typical behavior of the resistance of a platinum RTD over a range of temperature.

**Figure 2: Resistance Change vs. Temperature for Platinum RTD (PT100)**

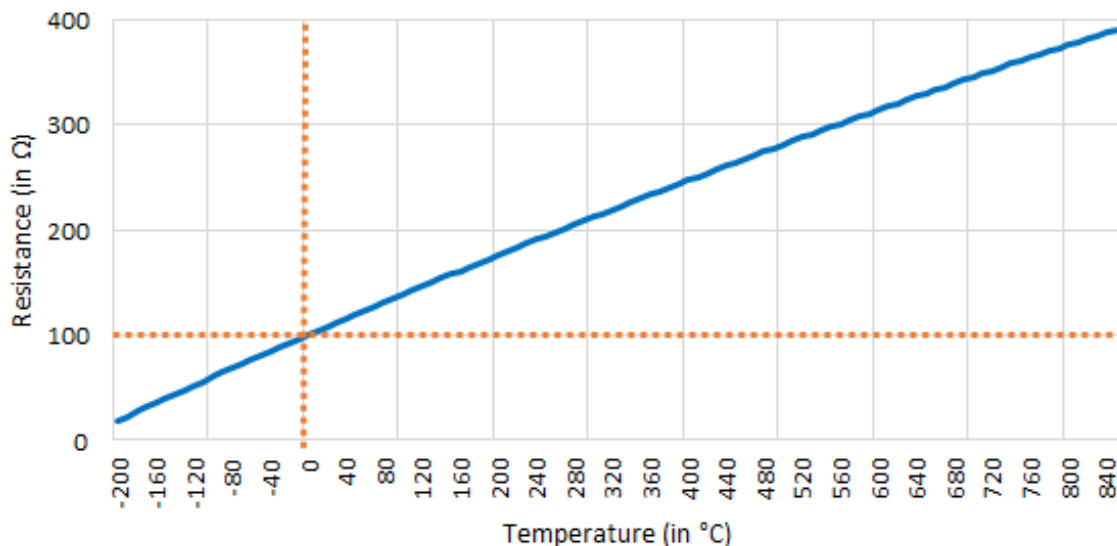

Emerson offers the two most common styles of RTD sensors: thin-film and wire-wound. Wire-wound RTDs are manufactured by winding the resistive wire in a helical shape supported in a ceramic sheath – hence the name wire-wound. Thin-film RTDs are manufactured with a thin resistive coating that is deposited on a flat, usually rectangular ceramic substrate.

Figure 3: RTD Elements

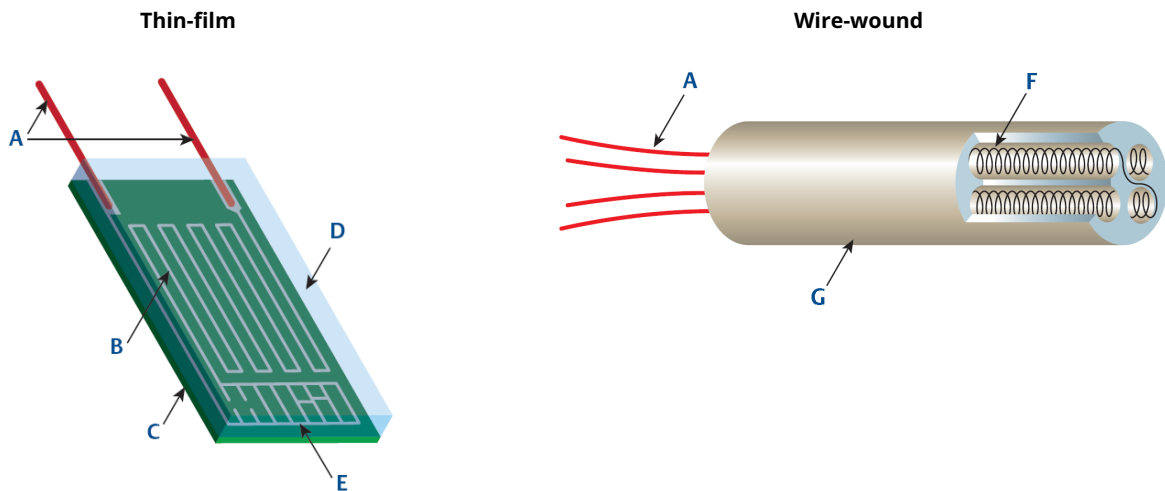

- A. Element leads
- B. Deposited platinum resistive pattern
- C. Ceramic substrate
- D. Glass encapsulation
- E. Resistance trim area
- F. Coiled high purity platinum sensing wire
- G. High purity ceramic insulation

**Thin-film RTD (RT, RH)**

Thin-film elements are generally better in vibration and physical shock. With a platinum construction (PT100) and a temperature coefficient  $\alpha = 0.00385$ , these elements can be rated between  $-76$  to  $1112$  °F ( $-60$  to  $600$  °C).

**Wire-wound RTD (RW)**

When a lower temperature range is required for an RTD, the wire-wound element is a better choice. The RW option code is for wire-wound RTDs which are for  $-321$  to  $1112$  °F ( $-196$  to  $600$  °C). Similar to the thin-film element, this element has a platinum construction (PT100) and an alpha value of  $\alpha = 0.00385$ . Because of its lower temperature range, this option should be chosen for low temperature applications (below  $-76$  °F [ $-60$  °C]).

**Table 3: RTD Comparison**

Option code	Element type	Temperature range	Good for	Accuracy
RT	Thin film	( $-58$ to $842$ °F) $-50$ to $450$ °C	Higher vibration and physical shock	Class A; Class B
RW	Wire wound	( $-321$ to $1112$ °F) $-196$ to $600$ °C	Higher accuracy and low temperature applications	Class A; Class B
RH	High temperature thin film	( $-76$ to $1112$ °F) $-60$ to $600$ °C	Higher temperature applications, resistance to vibration, and physical shock	Class B

Back to [Thermocouple ordering information](#).

**Thermocouple**

A thermocouple (T/C) is a closed-circuit thermoelectric temperature sensing device consisting of two wires of dissimilar metals joined at both ends. A current is created when the temperature at one end or junction differs from the temperature at the other end. This phenomenon is known as the Seebeck effect, which is the basis for thermocouple temperature measurements.

One end is referred to as the hot junction whereas the other end is referred to as the cold junction. The hot junction measuring element is placed inside a sensor sheath and exposed to the process. The cold junction, or the reference junction, is the termination point outside of the process where the temperature is known and where the voltage is being measured (e.g. in a transmitter, control system input card, or other signal conditioner).

According to the Seebeck effect, a voltage measured at the cold junction is proportional to the difference in temperature between the hot junction and the cold junction. This voltage may be referred to as the Seebeck voltage, thermoelectric voltage, or thermoelectric EMF. As the temperature rises at the hot junction, the observed voltage at the cold junction also increases non-linearly with the rising temperature. The linearity of the temperature-voltage relationship depends on the combination of metals used to make the T/C.

There are many types of T/C that use various metal combinations. These combinations have different output characteristics that define the applicable temperature range it can measure and the corresponding voltage output. The higher the magnitude of the voltage output the higher the measurement resolution, which increases repeatability and accuracy. There are trade-offs between measurement resolutions and temperature ranges which suits individual T/C types to specific ranges and applications. Refer to [Figure 4](#) for different thermocouple behavior over a range of temperatures.

**Figure 4: Thermocouple Temperature Ranges**



Emerson offers a variety of thermocouples: Type E, Type J, Type K, Type N, and Type T.

**Table 4: Thermocouple Types**

Option code	Element type	Metals	Temperature range	Good for
TE	Type E	Chromel-constantan	-40 to 1,500 °F (-40 to 816 °C)	Medium temperature ranges continuously oxidizing or inert atmospheres.
TJ	Type J	Iron-constantan	-40 to 1,400 °F (-40 to 760 °C)	Medium temperature ranges
TK	Type K	Chromel-Alumel	-40 to 2,192 °F (-40 to 1,200 °C)	High temperature ranges

**Table 4: Thermocouple Types (continued)**

Option code	Element type	Metals	Temperature range	Good for
TN	Type N	Nicrosil-Nisil	-40 to 2,192 °F (-40 to 1,200 °C)	High temperature ranges with higher thermoelectric stability than Type K
TT	Type T	Copper-constantan	-321 to 698 °F (-196 to 370 °C)	Low (cryogenic) temperature ranges

**Type E (TE)**

**Figure 5: Type E Thermocouple Colors**

**ASTM color codes**



**IEC color codes**



Constructed of Chromel and constantan, Type E thermocouples have a potential temperature range of -40 to 1500 °F (-40 to 816 °C), and a sensitivity of about 68µV/°C. It also has a tendency to drift more than the other types. It is recommended for continuously oxidizing or inert atmospheres. Its limits of error have not been established for use below zero.

**Type J (TJ)**

**Figure 6: Type J Thermocouple Colors**

**ASTM color codes**



**IEC color codes**



Constructed of iron and constantan, Type J thermocouples have a potential temperature range of -40 to 1400 °F (-40 to 760 °C), and a sensitivity of about 50 µV/°C. Type J thermocouples become brittle below 32 °F (0 °C) and are suitable for use in vacuum, reducing, or inert atmospheres. These thermocouples will have a reduced life if used in an oxidizing atmosphere.

**Type K (TK)**

**Figure 7: Type K Thermocouple Colors**

**ASTM color codes**



**IEC color codes**



Constructed of Chromel and Alumel materials, Type K thermocouples are one of the most common general purpose thermocouples, have a potential temperature range of -40 to 2192 °F (-40 to 1200 °C), and a sensitivity of approximately 41  $\mu\text{V}/^\circ\text{C}$ . Type K thermocouples are relatively linear and may be used in continuously oxidizing or neutral atmospheres, and are typically used above 1000 °F (538 °C).

**Type N (TN)**

**Figure 8: Type N Thermocouple Colors**

**ASTM color codes**



**IEC color codes**



Constructed of Nicrosil and Nisil, Type N thermocouples have a potential temperature range of -40 to 2192 °F (-40 to 1,200 °C), and a sensitivity of about 39  $\mu\text{V}/^\circ\text{C}$ . Some studies have shown that, in oxidizing atmospheres, the thermoelectric stability of the type N thermocouple is about the same as that of the noble-metal thermocouples of ANSI types R and S up to about 1200 °C (2192 °F) Type N thermocouples should not be placed in vacuums or reducing or alternating reducing/ oxidizing atmospheres.

**Type T (TT)**

**Figure 9: Type T Thermocouple Colors**

**ASTM color codes**



**IEC color codes**



Constructed of copper and constantan, Type T thermocouples have a potential temperature range of -321 to 698 °F (-196 to 370 °C) and a sensitivity of 38  $\mu\text{V}/^\circ\text{C}$ . Type T thermocouples demonstrate a good linearity and can be used in oxidizing, reducing or inert atmospheres, as well as in a vacuum. These thermocouples exhibit a high resistance to moisture corrosion, and are typically used in very low (cryogenic) to medium temperature ranges.



## Sheath material

Back to [RTD ordering information](#).

(SM)

For RTDs, Emerson offers a protective sheath made of 316 SST. This material has an maximum operating temperature limit of 1650 °F (900 °C).

Back to [Thermocouple ordering information](#).

(SM)

For Type E, J, and T thermocouples, Emerson offers a protective sheath made of 321 SST. This material is a stainless steel stabilized by adding titanium. This gives it excellent resistance to intergranular corrosion after exposure to high temperatures (above 800 °F [427 °C]). Material 321 has a maximum operating temperature limit of 1500 °F (816 °C). The operating temperature range for the sensor element will constrain this limit. See [Table 3](#) and [Table 4](#) for the temperature range of the different sensor element types. This material is only available for Type E, J, and T thermocouples.

(AK)

For Type K and N thermocouples, Emerson offers a protective sheath made of Alloy 600. This material is a nickel-chromium alloy with good oxidation resistance at higher temperatures. Alloy 600 is designed for use in the temperature range of -40 to 2192 °F (-40 to 1200 °C). The operating temperature range for the sensor element will be constrained by this limit. This material is only available for Type K and N thermocouples.

## Sensor accuracy

Back to [RTD ordering information](#).

Back to [Thermocouple ordering information](#).

(A1, B1)

The thin-film option code RH is available in Class B accuracy only, whereas the thin-film option code RT is available in both Class A and Class B accuracy.

The wire-wound option code RW is intended for applications that require high accuracy and/or subjected to low temperatures. Option code RW is available with Class A accuracy over -148 to 842 °F (-100 to 450 °C).

[Table 5](#) shows the interchangeability of RTD sensors. It explains the tolerance for Class A and Class B accuracy RTDs over a specific temperature range. The performance of the option codes RT, RH, and RW sensors conform to the standard set by IEC 60751. [Figure 10](#) is a graphical representation that demonstrates the Class A and Class B accuracy curve over temperature per IEC 60751. For maximum system accuracy, Emerson can provide sensor calibration and optional sensor-to-transmitter matching obtainable through the use of Callendar-Van Dusen constants. See [Calibration](#) for additional calibration offering.

**Table 5: Interchangeability Error for RTD per IEC 60751**

°C (°F)	Tolerancer in °C (°F)				
	Class B for RTD Model Option RT	Class A for RTD Model Option RT	Class B for RTD Model Option RW	Class A for RTD Model Option RW	Class B for RTD Model Option RH
-196 (-321)	N/A	N/A	±1.28 (2.30)	N/A	N/A
-100 (-148)	N/A	N/A	±0.8 (1.44)	±0.35 (0.63)	N/A
-50 (-58)	±0.55 (0.99)	N/A	±0.55 (0.99)	±0.25 (0.45)	±0.55 (0.99)
0 (32)	±0.3 (0.54)	±0.15 (0.27)	±0.3 (0.54)	±0.15 (0.27)	±0.3 (0.54)
100 (212)	±0.8 (1.44)	±0.35 (0.63)	±0.8 (1.44)	±0.35 (0.63)	±0.8 (1.44)
200 (392)	±1.3 (2.34)	±0.55 (0.99)	±1.3 (2.34)	±0.55 (0.99)	±1.3 (2.34)
300 (572)	±1.8 (3.24)	±0.75 (1.35)	±1.8 (3.24)	±0.75 (1.35)	±1.8 (3.24)
450 (842)	±2.55 (4.59)	N/A	±2.55 (4.59)	±1.05 (1.89)	±2.55 (4.59)
500 (932)	N/A	N/A	±2.8 (5.04)	N/A	±2.8 (5.04)
600 (1112)	N/A	N/A	±3.3 (5.94)	N/A	±3.3 (5.94)

**Figure 10: Sensor Accuracy Curve**

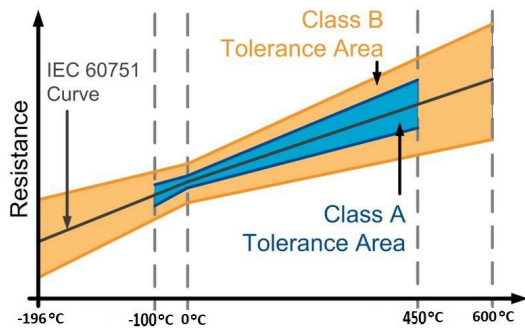

**(T1, T2, SP, ST)**

Similar to RTDs, thermocouples also can have tolerances as defined by national standards. According to IEC 60584, thermocouples can have a narrower tolerance (or higher accuracy) of Class 1. Class 1 thermocouples are manufactured with higher grade wire, which increases their accuracy reading. Class 2, on the other hand, has a wider accuracy error margin since they are manufactured with standard thermocouple grade wires.

Emerson also provides thermocouples that meet tolerances per ASTM E230 standards. Special Tolerances are approximately half of accuracy error margin than Standard Tolerances since they are made with higher grade wire.

**Number of elements**

Back to [RTD ordering information](#).

Back to [Thermocouple ordering information](#).

**(S3, S4, D3)**

For applications where a generic RTD temperature measurement is sufficient, select option S3 for a single, 3-wire measurement. For better results, select option S4 for a single, 4-wire measurement. For added measurement reassurance, select option D3 for a dual, 3-wire measurement.

Since the lead wires are part of the RTD circuit, the lead wire resistance needs to be compensated for to achieve the best accuracy. This becomes especially critical in applications where long sensor and/or lead wires are used. Emerson provides two lead wire configurations that are commonly available: 3-wire and 4-wire.

In a 4-wire configuration, the lead wire resistance is inconsequential to the measurement. It uses a measurement technique where a very small constant current of about 150  $\mu\text{A}$  is applied to the sensor through two leads and the voltage developed across the sensor is measured over the other two wires with a high-impedance and high resolution measuring circuit. In accordance with Ohm's Law the high impedance virtually eliminates any current flow in the voltage measurement leads and therefore the resistance of the leads is not a factor.

In a 3-wire configuration, compensation is accomplished using a third wire with the assumption that it will be the same resistance as the other two wires and the same compensation is applied to all three wires.

Lead wire configurations can be programmed in Emerson's Rosemount Temperature Transmitters since they are capable of compensating for the various configurations.

All of the available lead wire configurations conform to IEC 60751. As a result, the wire colors for the sensor match what is defined by the standard.

A 4-wire sensor can also be used in a 2- or 3- wire configuration. To properly wire the 4-wire RTD for use in a 2-, 3-, or 4-wire configuration, refer to the Rosemount 214C [Quick Start Guide](#).

**Figure 11: RTD Lead Wire Configurations**

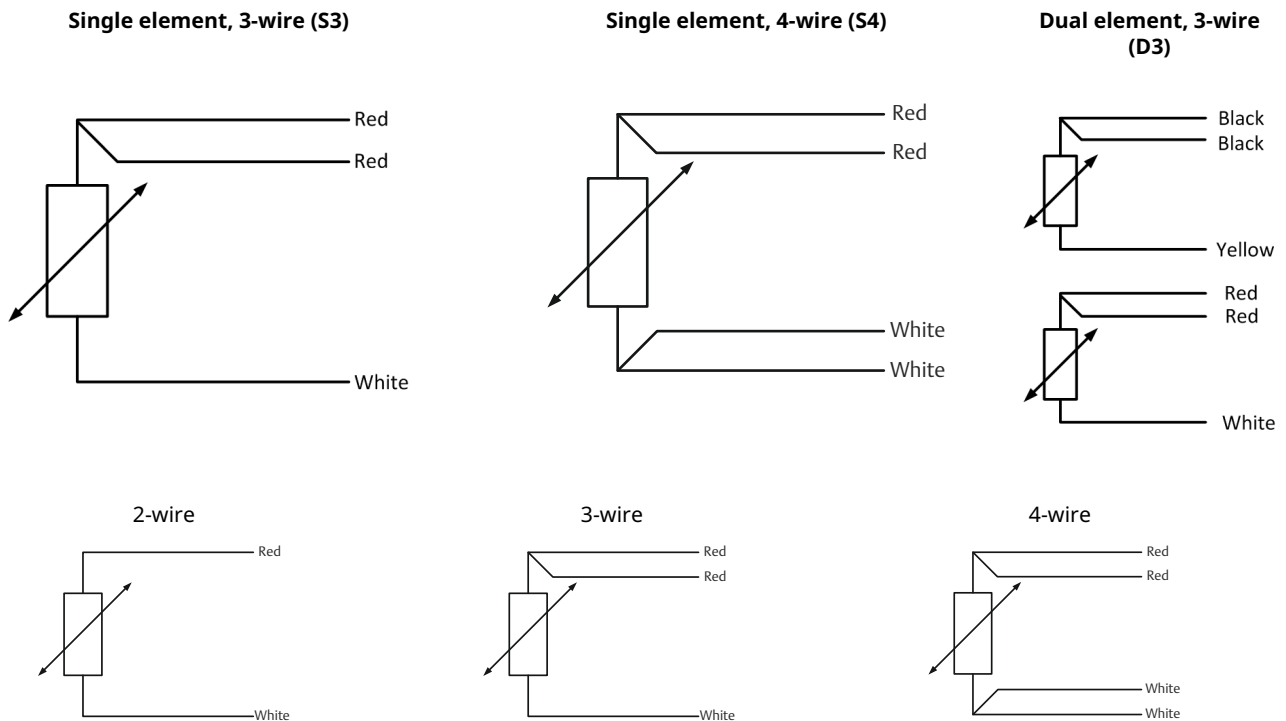

**(SG, SU, DG, DU)**

For generic thermocouple measurements, select option SG for a single, grounded junction thermocouple measurement. This grounded configuration provides contact to the sheath for faster response time; however, this is more susceptible to induced noise from ground loops. This can be avoided by selecting option SU for single, ungrounded thermocouple configuration. This particular type provides a more accurate reading than a single, grounded thermocouple, but with a slower response time due to its isolation.

For added redundancy in the temperature measurement, select option DG for dual, grounded, unisolated configuration; or option DU for dual, ungrounded, isolated sensor wire configuration. See [Figure 12](#) for all available configurations.

**Figure 12: Thermocouple Lead Wire Configurations**

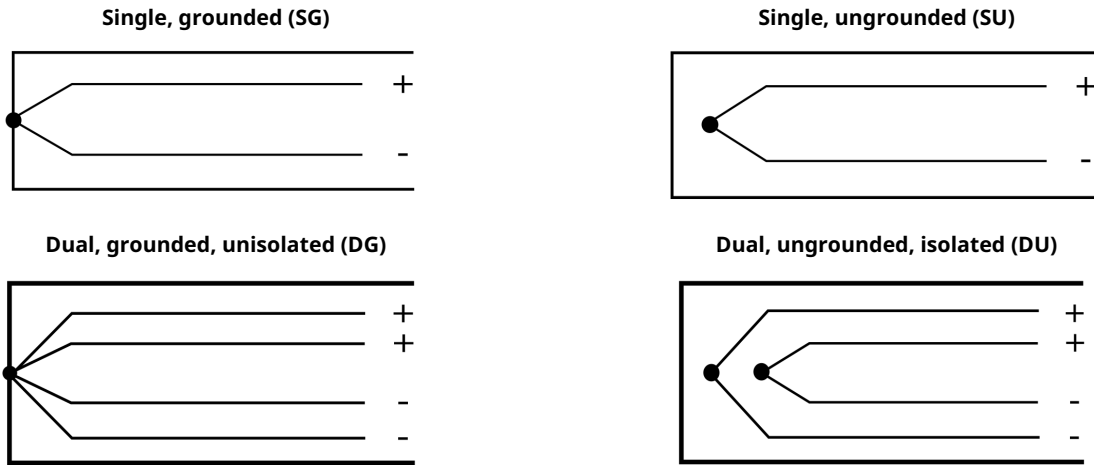

## Dimension units

Back to [RTD ordering information](#).

Back to [Thermocouple ordering information](#).

These dimensional units determine both the sensor insertion length and the extension length through the model.

### English/U.S. customary units (E)

If English/U.S. customary units is selected, then all lengths will be in inches.

### Metric (M)

If metric is selected, then all lengths will be in millimeters.

## Sensor insertion length

Back to [RTD ordering information](#).

Back to [Thermocouple ordering information](#).

Sensor insertion length can be ordered by specifying a four-digit option code. However, when ordering, the second decimal place is dropped off.

When ordering in inches, the length can be ordered in ¼-in. increments. Here are some examples:

- 120.25-in. = 1202
- 62.75-in. = 0627

When ordering in millimeters, the length can be ordered in 1 mm increments. Here are some examples:

- 34 mm = 0034
- 325 mm = 0325

## Determining the length (L) of a replacement spring-loaded sensor in existing installation

### To replace only the sensor

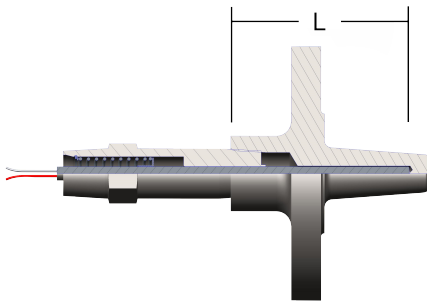

### Procedure

1. Remove the existing sensor from the installation.
2. Measure the sensor length with the spring in the relaxed state from the tip of the sensor to the thread engagement point of 0.5-in. (13 mm) into the adapter threads.
3. Subtract 0.25-in. (6 mm) from your measurement. The resulting length is (L). Use this length to specify the sensor insertion length in the ordering table.

### To replace the sensor and extension

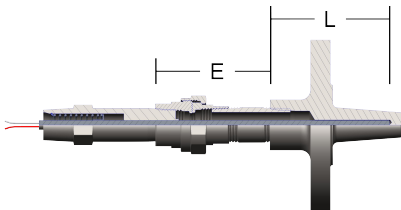

### Procedure

1. Remove the existing sensor and extension from the installed thermowell.
2. Measure the sensor length with the spring in the relaxed state from the tip of the sensor to the thread engagement point of 0.5-in. (13 mm) into the extension threads.
3. Subtract 0.25-in. (6 mm) from your measurement. The resulting length is (L). Use this length to specify the sensor insertion length in the ordering table.
4. Measure the extension length from thermowell connection to the adapter/fitting connection accounting for 0.5-in. (13 mm) thread engagement. The resulting length is (E). Use this length to specify the extension length in the ordering table (see [Extension length](#)).

### Note

Emerson standardizes on a spring compression of 0.5-in. (13 mm) for all spring loaded and compact spring loaded mounting styles for sensors. The thermowell tip thickness is assumed to be 0.25-in. (6 mm) and the sensors are built 0.25-in. (6 mm) longer than the ordered length to ensure contact to the thermowell tip.

To ensure sensor fits the Rosemount 114C Thermowell, refer to [Ensure sensor fits thermowell](#).

## Determining the length (X) of a replacement DIN style sensor in existing installation

To replace only the sensor

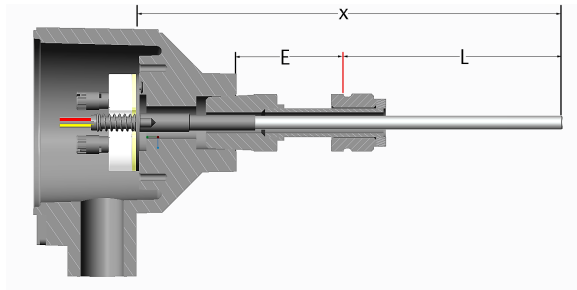

### Procedure

1. Remove the existing sensor from the installation.
2. Measure the sensor length from the tip of the sensor to the bottom of the DIN plate.
3. The resulting length is (X). Use this length to specify the sensor insertion length in the ordering table.

## Sensor mounting style

Back to [RTD ordering information](#).

Back to [Thermocouple ordering information](#).

Emerson offers a variety of mounting style options for every sensor. Depending on the application needs and constraints, a certain type of mounting style may be preferred. See description of each style and their dimensions below.

### Threaded style mounting adapters

The threaded style is a sensor with a threaded adapter to provide a connection to the process and connection head. The benefit of the threaded style is the ability to install it directly into a process or thermowell without any additional mounting fittings. Emerson currently offers two different threaded mounting styles: Spring loaded adapter and Compact spring loaded adapter.

#### Spring-loaded adapter (SL)

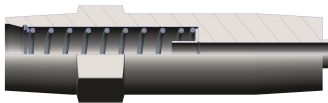

A spring located in the threaded adapter allows the sensor to travel, ensuring contact with the bottom of a thermowell. This helps ensure better sensor accuracy, improved sensor response time and aids in providing better performance while under vibration.

Figure 13: Dimensions

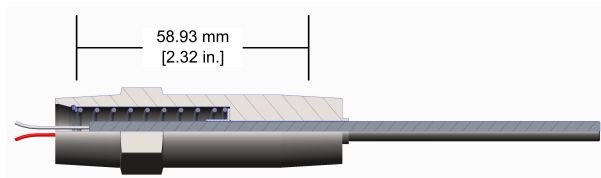

**Compact spring loaded adapter (SC)**

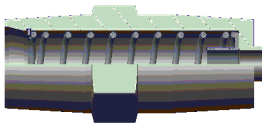

When space is limited, Emerson provides a compact spring loaded adapter. This adapter has a length of 29.21 mm (1.15-in.) as shown in [Figure 14](#). It is also an excellent option for when explosionproof approvals are not a concern yet continuous contact to the thermowell tip is required.

**Figure 14: Dimensions**

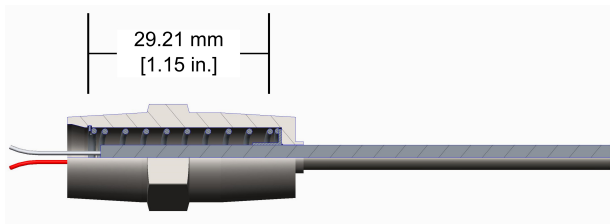

**Spring loaded adapter with thermowell contact indication (SW)**

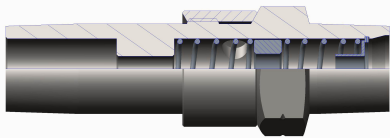

This spring loaded adapter contains a small opening on the side of the adapter giving this design an added advantage of a visual indication of the sensor contact to the tip of the thermowell. This design is slightly larger with a length of 66.04 mm (2.60-in.).

**Figure 15: Dimensions**

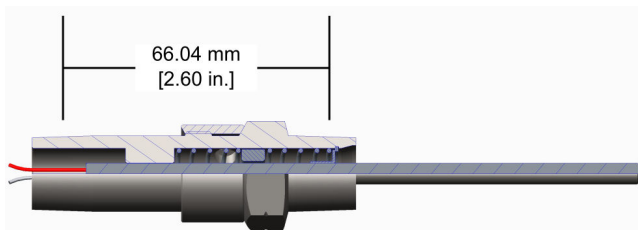



**Welded adapter (WA)**

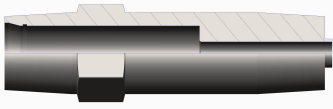

Unlike the spring loaded style, the welded adapter does not contain a spring in the design. Instead, the mounting adapter is welded to the body of the sensor that creates a seal when immersed directly into the process. This seal is rated for 3500 psi.

**Figure 16: Dimensions**

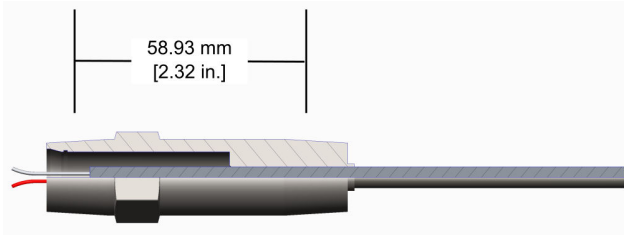

**Compact welded adapter (WC)**

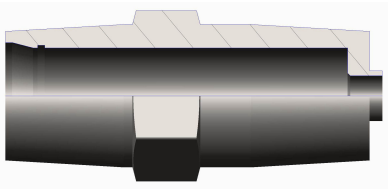

Similar size as the compact spring loaded adapter, the compact welded adapter does not contain a spring and the mounting adapter is instead welded to the body of the sensor. This adapter has a length of 29.21 mm (1.15-in.).

**Figure 17: Dimensions**

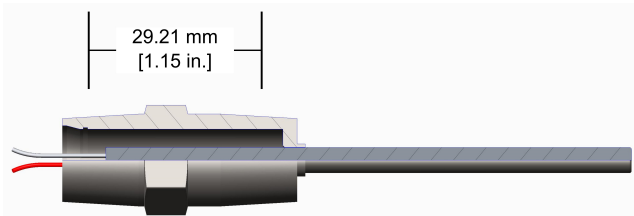

**Adjustable spring loaded fitting (SA)**

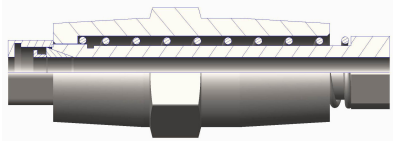

A spring located in the adjustable threaded compression fitting allows the sensor to travel ensuring contact to the bottom of a thermowell. As a result, this adjustable fitting allows for installation along the body of a sensor capsule that can be of any length.

**Figure 18: Dimensions**

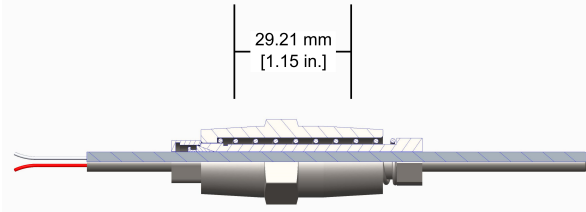

**Compression fittings (CA, CB, CC, CD)**

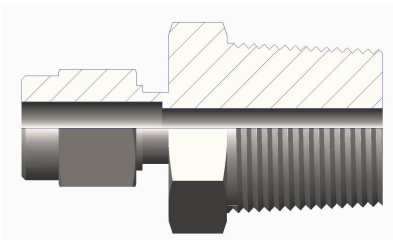

An adjustable fitting that allows for installation along the body of a sensor capsule. This limits the need to stock various lengths of sensors. Instead it only requires to insert the sensor in the process or thermowell, adjust the fitting to length and tighten it on to the sensor sheath; allowing for quick set temperature measurement points.

**DIN-style mounting (DF and DT)**



**DIN mounting plate with flying leads (DF)**

DIN-style mounting plate allows for assembly with head-mount temperature transmitters attached directly to the sensor. The flying lead configuration allows for the removal of the sensor and transmitter as one assembly.



**DIN mounting plate with terminal block (DT)**

DIN-style mounting plate with built-in terminal block allows for remote mounting and easy sensor assembly and replacement. Can be mounted together with transmitters using a BUZH connection head.

**Sensor only (SO)**



Sensor capsule without any fittings or adapters.

## 316SST Material options (M1, M2)

Back to [RTD ordering information](#).

Back to [Thermocouple ordering information](#).

The M1 option changes out the original 304SST wire on tag to a corrosion resistant 316SST wire on tag while the M2 option changes out the following components:

1. Wire on tag
2. Name plate
3. Adapter
4. Drive screws
5. Conduit cable glands
6. Cover chain (except AT1 and AT3)

---

### Note

The components listed above are replaced with corrosion resistant 316SST components.

---

# Product certifications

Rev 2.23

## European Directive information

A copy of the EU Declaration of Conformity can be found at the end of the Quick Start Guide. The most recent revision of the EU Declaration of Conformity can be found at [Emerson.com/Rosemount](https://www.emerson.com/Rosemount).

## Ordinary Location Certification

The Rosemount 214C has been examined and tested to determine that the design meets the basic electrical, mechanical, and fire protection requirements by a nationally recognized test laboratory (NRTL) as accredited by the Federal Occupational Safety and Health Administration (OSHA).

### Note

The terminal strip in the Aluminum with Terminal Strip (AT1 or AT3) connection head requires sensor lead wires to have a wire termination (Ex: Bootlace ferrule or spade lug).

## North America

The US National Electrical Code® (NEC) and the Canadian Electrical Code (CEC) permit the use of Division marked equipment in Zones and Zone marked equipment in Divisions. The markings must be suitable for the area classification, gas, and temperature class. This information is clearly defined in the respective codes.

## North America

### E5 USA Explosionproof (XP) and Dust-Ignitionproof (DIP)

**Certificate** 70044744

**Standards** FM 3600:2011, FM 3615:2006, UL 50E:2007, UL 61010-1:2010, ANSI/ISA 60529:2004

**Markings** XP CL I, DIV 1, GP B, C, D; DIP CL II, DIV 1, GP E, F, G; CL III; T6 (-50 °C ≤ T<sub>a</sub> ≤ +80 °C), T5 (-50 °C ≤ T<sub>a</sub> ≤ +95 °C); Seal not required; installed per Rosemount drawing 00214-1030; Type 4X<sup>†</sup> and IP 66/67; V<sub>max</sub> 35 Vdc, 750 mW<sub>max</sub>

#### Special Conditions for Safe Use (X):

1. Flameproof joints are not intended for repair.
2. Cable entries must be used which maintain the ingress protection of the enclosure. Unused cable entries must be filled with suitable blanking plugs.

### N5 USA Division 2 (NI)

**Certificate** 70044744

**Standards** FM 3600:2011, FM 3611:2004, UL 50E:2007, UL 61010-1:2010, ANSI/ISA 60529:2004

**Markings** NI CL I, DIV 2, GP A, B, C, D; T6 (-50 °C ≤ T<sub>a</sub> ≤ +80 °C), T5 (-50 °C ≤ T<sub>a</sub> ≤ +95 °C); installed per Rosemount drawing 00214-1030; Type 4X<sup>†</sup> and IP 66/67; V<sub>max</sub> 35 Vdc, 750 mW<sub>max</sub>

### E6 Canada Explosionproof (XP) and Dust-Ignitionproof (DIP)

**Certificate** 70044744

**Standards** CAN/CSA C22.2 No. 0:2010, CAN/CSA No. 25-1966 (R2000), CAN/CSA C22.2 No. 30-M1986 (R2012), CAN/CSA C22.2 No. 94-M1991 (R2011), CAN/CSA C22.2 No. 61010-1:2012

**Markings** XP CL I, DIV 1, GP B\*, C, D; DIP CL II, DIV 1, GP E, F, G; CL III; T6 (-50 °C ≤ T<sub>a</sub> ≤ +80 °C), T5 (-50 °C ≤ T<sub>a</sub> ≤ +95 °C); Seal not required; installed per Rosemount drawing 00214-1030; Type 4X<sup>†</sup> and IP 66/67; V<sub>max</sub> 35 Vdc, 750 mW<sub>max</sub>

**Special Conditions for Safe Use (X):**

1. Flameproof joints are not intended for repair.
2. Cable entries must be used which maintain the ingress protection of the enclosure. Unused cable entries must be filled with suitable blanking plugs.

**N6 Canada Division 2**

**Certificate** 70044744

**Standards** CAN/CSA C22.2 No. 0:2010, CAN/CSA C22.2 No. 94-M1991 (R2011), CAN/CSA No. 213-M1987 (R2013), CAN/CSA C22.2 No. 61010-1:2012

**Markings** CL I, DIV 2, GP A, B, C, D; T6; (-50 °C ≤ T<sub>a</sub> ≤ +80 °C), T5 (-50 °C ≤ T<sub>a</sub> ≤ +95 °C); installed per Rosemount drawing 00214-1030; Type 4X<sup>†</sup> and IP 66/67; V<sub>max</sub> 35 Vdc, 750 mW<sub>max</sub>

<sup>†</sup>Spring loaded indicator has reduced ingress and dust ratings. Spring loaded sensors must be installed in a thermowell to maintain dust and ingress ratings. Un-painted aluminum enclosures are Type 4 rated. \*Assembly is not Canada Explosionproof (E6) rated to Group B if the AT1 (Aluminum with Terminal Strip) connection head is used.

**Europe**

**E1 ATEX Flameproof**

**Certificate** DEKRA 19ATEX0076 X

**Standards** EN IEC 60079-0: 2018, EN 60079-1: 2014

**Markings** Ⓔ II 2 G Ex db IIC T6...T1 Gb, (-60 °C ≤ T<sub>a</sub> ≤ +80 °C)

**Special Conditions for Safe Use (X):**

1. Flameproof joints are not intended for repair.
2. Non-Standard Paint options may cause risk from electrostatic discharge. Avoid installations that cause electrostatic build-up on painted surfaces, and only clean the painted surfaces with a damp cloth. If paint is ordered through a special option code, contact the manufacturer for more information.
3. When provided on their own, the adapter style sensors must be assembled to a suitable Ex db enclosure with a free internal volume no greater than 550 cm<sup>3</sup>.
4. Guard DIN sensors against impacts greater than 4 J.

Process temperature range (°C) <sup>(1)</sup>	Ambient temperature range (°C) <sup>(1)</sup>	Temperature class
-60 °C to +80 °C	-60 °C to +80 °C	T6
-60 °C to +95 °C	-60 °C to +80 °C	T5
-60 °C to +130 °C	-60 °C to +80 °C	T4
-60 °C to +195 °C	-60 °C to +80 °C	T3
-60 °C to +290 °C	-60 °C to +80 °C	T2
-60 °C to +440 °C	-60 °C to +80 °C	T1

(1) *Min. process temperature and min. ambient temperature is limited to -50 °C for models with enclosure designation "AD1" or "SD1".*

### I1 ATEX Intrinsic Safety

**Certificate** Baseefa16ATEX0101X  
**Standards** Baseefa16ATEX0101X  
**Markings** Ⓢ II 1 G Ex ia IIC T5/T6 Ga (SEE CERTIFICATE FOR SCHEDULE)

Thermocouples; P <sub>i</sub> = 500 mW	T6 -60 °C ≤ T <sub>a</sub> ≤ +70 °C
RTDs; P <sub>i</sub> = 192 mW	T6 -60 °C ≤ T <sub>a</sub> ≤ +70 °C
RTDs; P <sub>i</sub> = 290 mW	T6 -60 °C ≤ T <sub>a</sub> ≤ +60 °C
	T5 -60 °C ≤ T <sub>a</sub> ≤ +70 °C

**Special Condition for Safe Use (X):**

The equipment must be installed in an enclosure which affords it a degree of ingress protection of at least IP20.

### N1 ATEX Zone 2

**Certificate** BAS00ATEX3145  
**Standards** EN 60079-0:2012+A11:2013, EN 60079-15:2010  
**Markings** Ⓢ II 3 G Ex nA IIC T5 Gc (-40 °C ≤ T<sub>a</sub> ≤ 70 °C)

### ND ATEX Dust Ignitionproof

**Certificate** DEKRA 19ATEX0076 X  
**Standards** EN IEC 60079-0:2018, EN 60079-31:2014  
**Markings** Ⓢ II 2 D Ex tb IIIC T130 °C Db, (-60 °C ≤ T<sub>a</sub> ≤ +80 °C)

**Special Conditions for Safe Use (X):**

1. Non-Standard Paint options may cause risk from electrostatic discharge. Avoid installations that cause electrostatic build-up on painted surfaces, and only clean the painted surfaces with a damp cloth. If paint is ordered through a special option code, contact the manufacturer for more information.
2. When provided on their own, the adapter style sensors must be assembled to a suitable Ex tb enclosure with a free internal volume no greater than 550 cm<sup>3</sup>.
3. The spring loaded adapter style sensors and DIN style sensors must be installed in a thermowell to maintain Ex tb protection.
4. The contact indicating adapter style sensor does not meet the requirements for type of protection “tb”.

Process temperature range (°C) <sup>(1)</sup>	Ambient temperature range (°C) <sup>(1)</sup>	Maximum surface temperature “T”
-60 °C to +100 °C	-60 °C to +80 °C	T130 °C

(1) Min. process temperature and min. ambient temperature is limited to -50 °C for models with enclosure designation “AD1” or “SD1”.

## International

### E7 IECEx Flameproof

**Certificate** IECEx DEK 19.0041X

**Standards** IEC 60079-0: 2017, IEC 60079-1: 2014  
**Markings** Ex db IIC T6...T1 Gb (-60 °C ≤ T<sub>a</sub> ≤ +80 °C)

**Special Conditions for Safe Use (X):**

1. Flameproof joints are not intended for repair.
2. Non-Standard Paint options may cause risk from electrostatic discharge. Avoid installations that cause electrostatic build-up on painted surfaces, and only clean the painted surfaces with a damp cloth. If paint is ordered through a special option code, contact the manufacturer for more information.
3. When provided on their own, the adapter style sensors must be assembled to a suitable Ex db enclosure with a free internal volume no greater than 550 cm<sup>3</sup>.
4. Guard DIN sensors against impacts greater than 4 J.

Process temperature range (°C) <sup>(1)</sup>	Ambient temperature range (°C) <sup>(1)</sup>	Temperature class
-60 °C to +80 °C	-60 °C to +80 °C	T6
-60 °C to +95 °C	-60 °C to +80 °C	T5
-60 °C to +130 °C	-60 °C to +80 °C	T4
-60 °C to +195 °C	-60 °C to +80 °C	T3
-60 °C to +290 °C	-60 °C to +80 °C	T2
-60 °C to +440 °C	-60 °C to +80 °C	T1

(1) Min. process temperature and min. ambient temperature is limited to -50 °C for models with enclosure designation "AD1" or "SD1".

**I7 IECEx Intrinsic Safety**

**Certificate** IECEx BAS 16.0077X  
**Standards** IECEx BAS 16.0077X  
**Markings** Ex ia IIC T5/T6 Ga (SEE CERTIFICATE FOR SCHEDULE)

Thermocouples; P <sub>i</sub> = 500 mW	T6 -60 °C ≤ T <sub>a</sub> ≤ +70 °C
RTDs; P <sub>i</sub> = 192 mW	T6 -60 °C ≤ T <sub>a</sub> ≤ +70 °C
RTDs; P <sub>i</sub> = 290 mW	T6 -60 °C ≤ T <sub>a</sub> ≤ +60 °C
	T5 -60 °C ≤ T <sub>a</sub> ≤ +70 °C

**Special Condition for Safe Use (X):**

The equipment must be installed in an enclosure which affords it a degree of ingress protection of at least IP20.

**N7 IECEx Zone 2**

**Certificate** IECEx BAS 07.0055  
**Standards** IEC 60079-0:2011, IEC 60079-15:2010  
**Markings** Ex nA IIC T5 Gc; T5 (-40 °C ≤ T<sub>a</sub> ≤ +70 °C)

**NK IECEx Dust Ignitionproof**

**Certificate** IECEx DEK 19.0041X

**Standards** IEC 60079-0:2017 and IEC 60079-31:2013  
**Markings** Ex tb IIIC T130 °C Db, (-60 °C ≤ T<sub>a</sub> ≤ +80 °C)

**Special Conditions for Safe Use (X):**

1. Non-Standard Paint options may cause risk from electrostatic discharge. Avoid installations that cause electrostatic build-up on painted surfaces, and only clean the painted surfaces with a damp cloth. If paint is ordered through a special option code, contact the manufacturer for more information.
2. When provided on their own, the adapter style sensors must be assembled to a suitable Ex tb enclosure with a free internal volume no greater than 550 cm<sup>3</sup>.
3. The spring loaded adapter style sensors and DIN style sensors must be installed in a thermowell to maintain Ex tb protection. The contact indicating adapter style sensor does not meet the requirements for type of protection "tb".

Process temperature range (°C) <sup>(1)</sup>	Ambient temperature range (°C) <sup>(1)</sup>	Maximum surface temperature "T"
-60 °C to +100 °C	-60 °C to +80 °C	T130 °C

(1) Min. process temperature and min. ambient temperature is limited to -50 °C for models with enclosure designation "AD1" or "SD1".

## Brazil

### E2 Brazil Flameproof & Dust

**Certificate** UL-BR 21.1296X  
**Standards** ABNT NBR IEC 60079-0:2020, ABNT NBR IEC 60079-1:2016, ABNT NBR IEC 60079-31:2014  
**Markings** Ex db IIC T6...T1 Gb; T6...T1 (-60 °C ≤ T<sub>a</sub> ≤ +80°C), Ex tb IIIC T130°C Db ; (-60 °C ≤ T<sub>a</sub> ≤ +80 °C)

**Special Conditions for Safe Use (X):**

1. Flameproof joints are not intended for repair.
2. Non-Standard Paint options may cause risk from electrostatic discharge. Avoid installations that cause electrostatic build-up on painted surfaces, and only clean the painted surfaces with a damp cloth. If paint is ordered through a special option code, contact the manufacturer for more information.
3. When provided on their own, the adapter style sensors must be assembled to a suitable Ex db or Ex tb enclosure with a free internal volume no greater than 550 cm<sup>3</sup>.
4. The spring loaded adapter style sensors and DIN style sensors must be installed in a thermowell to maintain Ex tb protection.
5. The contact indicating adapter style sensor does not meet the requirements for type of protection "tb".
6. Guard DIN sensors against impacts greater than 4j.

Process temperature range (°C) <sup>1</sup>	Ambient temperture Range (°C) <sup>1</sup>	Temperature class / maximum surface temperature "T" <sup>1</sup>
-60 °C to +80 °C	-60 °C to +80 °C	T6
-60 °C to +95 °C	-60 °C to +80 °C	T5
-60 °C to +130 °C	-60 °C to +80 °C	T4
-60 °C to +195 °C	-60 °C to +80 °C	T3
-60 °C to +290 °C	-60 °C to +80 °C	T2



Process temperature range (°C) <sup>1</sup>	Ambient temperature Range (°C) <sup>1</sup>	Temperature class / maximum surface temperature "T" <sup>1</sup>
-60 °C to +440 °C	-60 °C to +80 °C	T1
-60 °C to +100 °C	-60 °C to +80 °C	T130 °C

<sup>1</sup>Min. process temperature and min. ambient temperature is limited to -50 °C for models with enclosure designation "AD1" or "SD1".

## I2 Brazil Intrinsic Safety

**Certificate** UL-BR 18.0257X

**Standards** ABNT NBR IEC 60079-0:2013, ABNT NBR IEC 60079-11:2013

**Markings** Ex ia IIC T6...T5 Ga Thermocouples: P<sub>i</sub> = 500 mW, T6 (-60 °C ≤ T<sub>a</sub> ≤ +70 °C) RTDs: P<sub>i</sub> = 192 mW, T6 (-60 °C ≤ T<sub>a</sub> ≤ +70 °C) P<sub>i</sub> = 290 mW, T6 (-60 °C ≤ T<sub>a</sub> ≤ +60 °C), T5 (-60 °C ≤ T<sub>a</sub> ≤ +70 °C)

### Special Condition for Safe Use (X):

The equipment must be installed in an enclosure which affords it a degree of ingress protection of at least IP20.

## China

### E3 China Flameproof

**Certificate** GYJ22.1915X (CCC 认证)

**Standards** GB/T 3836.1-2021, GB/T 3836.2-2021, GB/T 3836.31-2021

**Markings** Ex db IIC T6...T1 Gb, Ex tb IIIC T130 °C Db

\*Dust Ignitionproof approvals/markings are only available through the K3 option code.

产品安全使用特殊条件

证书编号后缀“X”表明产品具有安全使用特殊条件：

1. 涉及隔爆接合面的维修须联系产品制造商。
2. 传感器必须配备内部自由空间不超过 550cm<sup>3</sup> 的 Ex db 或 Ex tb 型外壳。
3. Spring loaded 型和 DIN 型传感器需要安装于套管内以实现 Ex tb 防爆型式。
4. Contact indicating adapter 型传感器不符合 Ex tb 防爆型式。
5. DIN 型传感器需要防止 4 J 以上能量的冲击。
6. 产品温度组别和使用环境温度及过程温度之间的关系为：

过程温度	环境温度	温度组别
-60 °C ≤ T <sub>a</sub> ≤ +80 °C	-60 °C ≤ T <sub>a</sub> ≤ +80 °C	T6
-60 °C ≤ T <sub>a</sub> ≤ +95 °C	-60 °C ≤ T <sub>a</sub> ≤ +80 °C	T5
-60 °C ≤ T <sub>a</sub> ≤ +130 °C	-60 °C ≤ T <sub>a</sub> ≤ +80 °C	T4
-60 °C ≤ T <sub>a</sub> ≤ +195 °C	-60 °C ≤ T <sub>a</sub> ≤ +80 °C	T3
-60 °C ≤ T <sub>a</sub> ≤ +290 °C	-60 °C ≤ T <sub>a</sub> ≤ +80 °C	T2
-60 °C ≤ T <sub>a</sub> ≤ +440 °C	-60 °C ≤ T <sub>a</sub> ≤ +80 °C	T1
-60 °C ≤ T <sub>a</sub> ≤ +100 °C	-60 °C ≤ T <sub>a</sub> ≤ +80 °C	T130 °C

注：选择 AD1、SD1 外壳时环境温度下限为-50 °C。

#### ■ 产品使用注意事项

1. 产品外壳设有接地端子，用户在使用时应可靠接地。
2. 安装现场应不存在对产品外壳有腐蚀作用的有害气体。
3. 现场安装时，电缆引入口须选用经国家指定的防爆检验机构检验认可、具有 Ex db II C Gb、Ex tb III C Db 防爆等级的电缆引入装置或堵封件，冗余电缆引入口须用堵封件有效密封。
4. 用于爆炸性气体环境中，现场安装、使用和维护必须严格遵守“断电后开盖！”的警告语。
5. 用于爆炸性粉尘环境中，产品外壳表面需保持清洁，以防粉尘堆积，但严禁用压缩空气吹扫。
6. 用户不得自行更换该产品的零部件，应会同产品制造商共同解决运行中出现的故障，以杜绝损坏现象的发生。
7. 产品的安装、使用和维护应同时遵守产品使用说明书、GB/T3836.13-2021“爆炸性环境 第 13 部分：设备的修理、检修、修复和改造”、GB/T3836.15-2017“爆炸性环境 第 15 部分：电气装置的设计、选型和安装”、GB/T3836.16-2017“爆炸性环境 第 16 部分：电气装置的检查与维护”、GB50257-2014“电气装置安装工程爆炸和火灾危险环境电力装置施工及验收规范”和 GB15577-2018“粉尘防爆安全规程”的有关规定。

### I3 China Intrinsic Safety

<b>Certificate</b>	GYJ22.3551X (CCC 认证)
<b>Standards</b>	GB/T 3836.1-2021, GB/T 3836.4-2021, GB 3836.20-2010
<b>Markings</b>	Ex ia IIC T6...T5 Ga

#### 产品安全使用特殊条件

证书编号后缀“X”表明产品具有安全使用特殊条件：产品必须安装于具有 IP20 外壳防护等级的外壳内方可使用。

#### 产品使用注意事项

1. 产品使用环境温度和温度组别的关系为：

传感器类型	最大输入功率 $P_i$ (mW)	温度组别	使用环境温度
热电偶	500	T6	-60 °C ~ +70 °C
RTD	192	T6	-60 °C ~ +70 °C
RTD	290	T6	-60 °C ~ +60 °C
		T5	-60 °C ~ +70 °C

2. 本安电气参数：

热电偶：

最高输入电压	最大输入电流	最大输入功率	最大内部等效参数	
$U_i$ (V)	$I_i$ (mA)	$P_i$ (mW)	$C_i$ (pF)	$L_i$ (nH)
60	100	500	75	600

最高输出电压 $U_o$ (V)	最大输出电流 $I_o$ (mA)	最大输出功率 $P_o$ (mW)
0.1	50	25

RTD:

最高输入电压	最大输入电流	最大输入功率	最大内部等效参数	
$U_i$ (V)	$I_i$ (mA)	$P_i$ (mW)	$C_i$ (pF)	$L_i$ (nH)
60	100	192/290	75	600

3. 该产品必须与已通过防爆认证的关联设备配套共同组成本安防爆系统方可使用于爆炸性气体环境。其系统接线必须同时遵守本产品 and 所配关联设备的使用说明书要求，接线端子不得接错。
4. 用户不得自行更换该产品的零部件，应会同产品制造商共同解决运行中出现的故障，以杜绝损坏现象的发生。
5. 产品的安装、使用和维护应同时遵守产品使用说明书、GB/T3836.13-2021 “爆炸性环境 第 13 部分：设备的修理、检修、修复和改造”、GB/T3836.15-2017 “爆炸性环境 第 15 部分：电气装置的设计、选型和安装”、GB/T3836.16-2017 “爆炸性环境 第 16 部分：电气装置的检查与维护” 和 GB50257-2014 “电气装置安装工程爆炸和火灾危险环境电力装置施工及验收规范” 的有关规定。

## Japan

### E4 Japan Flameproof

<b>Certificate</b>	CML 21JPN1842X
<b>Markings</b>	Ex db IIC T6...T1 Gb, (-60 °C ≤ T <sub>a</sub> ≤ +80 °C)

#### Special Conditions for Safe Use (X):

1. Flameproof joints are not intended for repair.
2. Non-Standard Paint options may cause risk from electrostatic discharge. Avoid installations that cause electrostatic build-up on painted surfaces, and only clean the painted surfaces with a damp cloth. If paint is ordered through a special option code, contact the manufacturer for more information.
3. See instructions for relation between process temperature, ambient temperature and temperature class.

#### Additional Special Conditions for Safe Use (X) when "XA" designation is ordered:

1. When provided on their own, the adapter style sensors must be assembled to a suitable Ex db enclosure with a free internal volume no greater than 550 cm<sup>3</sup>.
2. Guard DIN sensors against impacts greater than 4 J.

Process temperature range (°C) <sup>(1)</sup>	Ambient temperature range (°C) <sup>(1)</sup>	Temperature class
-60 °C to +80 °C	-60 °C to +80 °C	T6
-60 °C to +95 °C	-60 °C to +80 °C	T5
-60 °C to +130 °C	-60 °C to +80 °C	T4
-60 °C to +195 °C	-60 °C to +80 °C	T3
-60 °C to +290 °C	-60 °C to +80 °C	T2
-60 °C to +440 °C	-60 °C to +80 °C	T1

(1) Min. process temperature and min. ambient temperature is limited to -50 °C for models with enclosure designation "AD1" or "SD1".

## Korea

### EP Korea Flameproof

**Certificate** 22-KA4BO-0073X

**Markings** Ex db IIC T6...T1 Gb, T6 ( $-60\text{ °C} \leq T_a \leq +70\text{ °C}$ ), T5...T1 ( $-60\text{ °C} \leq T_a \leq +80\text{ °C}$ ),

**Special Condition for Safe Use (X):**

Refer to certificate for Special Conditions for Safe Use.

### IP Korea Intrinsic Safety

**Certificate** 17-KA4BO-0304X

**Markings** Ex ia IIC T6/T5

**Special Condition for Safe Use (X):**

Refer to certificate for details regarding process and ambient temperature limits as well as Special Conditions for Safe Use.

### KP Korea Flameproof, Dust Ignitionproof, and Intrinsic Safety

**Certificate** 22-KA4BO-0074X in addition to the EP and IP certificate numbers

**Markings** Ex tb IIIC T130 °C Db, ( $-60\text{ °C} \leq T_a \leq +80\text{ °C}$ ) in addition to the markings for EP and IP

**Special Condition for Safe Use (X):**

Refer to certificate for details regarding process and ambient temperature limits as well as Special Conditions for Safe Use.

## Russia

### EM Technical Regulation Customs Union TR CU 012/2011 (EAC) Flameproof

**Markings** 1Ex db IIC T6...T1 Gb X, T6 ( $-55\text{ °C} \leq T_a \leq +80\text{ °C}$ ), T5 ( $-55\text{ °C} \leq T_a \leq +95\text{ °C}$ ), T4...T1 ( $-55\text{ °C} \leq T_a \leq +100\text{ °C}$ )

**Special Condition for Safe Use (X):**

Refer to certificate for Special Conditions for Safe Use.

### IM Technical Regulation Customs Union TR CU 012/2011 (EAC) Intrinsic Safety

**Markings** 0Ex ia IIC T5,T6 Ga X

**Special Condition for Safe Use (X):**

Refer to certificate for details regarding process and ambient temperature limits as well as Special Conditions for Safe Use.

## KM Technical Regulation Customs Union TR CU 012/2011 (EAC) Flameproof, Dust-Ignitionproof, and Intrinsic Safety

**Markings** Ex tb IIIC T130 °C Db X in addition to the markings above for EM and IM.

### Special Condition for Safe Use (X):

Refer to certificate for details regarding process and ambient temperature limits as well as Special Conditions for Safe Use.

## Combinations



<b>K1</b>	Combination of E1, I1, N1, and ND
<b>K3</b>	Combination of E3 and I3
<b>K7</b>	Combination of E7, I7, N7, and NK
<b>KA</b>	Combination of E1 and E6
<b>KB</b>	Combination of E5 and E6
<b>KC</b>	Combination of E1 and E5
<b>KD</b>	Combination of E1, E5, and E6
<b>KE</b>	Combination of E1, E5, E6, and E7
<b>KM</b>	Combination of EM and IM
<b>KN</b>	Combination of N1, N5, N6, and N7
<b>KP</b>	Combination of EP and IP



## Connection heads

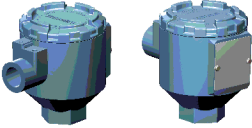

Back to [RTD ordering information](#).

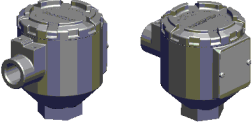
Back to [Thermocouple ordering information](#).

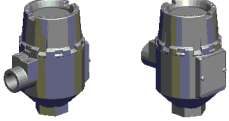
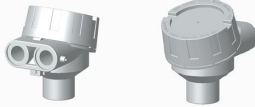
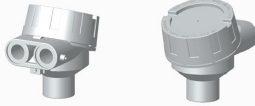
The connection heads provide high-level durability and mechanical protection for harsh environments. All connection heads are rated IP66/68 and NEMA® 4X.

Head description (code)	Corrosion resistance	Explosion proof design	Conduit options <sup>(1)</sup>	Conduit entries	Instrument connection <sup>(1)</sup>	Features	Recommendations
<b>Rosemount aluminum (AR1)</b> 	★★☆☆	Yes	½-in. NPT (C1); M20 (C2)	1	½-in. NPT (B1); M20 x 1.5 (B2); M24 x 1.5 (B3)	<ul style="list-style-type: none"> <li>Smallest explosion proof connection head</li> <li>Fits either DIN A or DIN B size transmitter</li> <li>Optional terminal block, stainless steel cover chain, external ground screw, or low temperature options also available</li> </ul>	Most popular connection head, used for many applications
<b>Rosemount aluminum with display cover (AR2)</b> 	★★☆☆	Yes	½-in. NPT (C1); M20 (C2)	1	½-in. NPT (B1); M20 x 1.5 (B2); M24 x 1.5 (B3)	<ul style="list-style-type: none"> <li>Allows LCD display use on the transmitter</li> <li>Allows you to see inside the connection head without removing cover</li> <li>Fits either DIN A or DIN B size transmitter</li> <li>Optional terminal block, external ground screw, or low temperature options also available</li> </ul>	Used with transmitters with displays
<b>Rosemount SST (SR1)</b> 	★★★☆☆	Yes	½-in. NPT (C1); M20 (C2)	1	½-in. NPT (B1); M20 x 1.5 (B2); M24 x 1.5 (B3)	<ul style="list-style-type: none"> <li>Smallest explosion proof stainless steel connection head</li> <li>Fits either DIN A or DIN B size transmitter</li> <li>Optional terminal block, stainless steel cover chain, external ground screw, or low temperature options also available</li> </ul>	Pick this option if an explosionproof connection head is required in a corrosive environment.

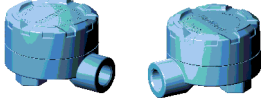
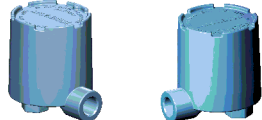
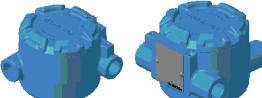
Head description (code)	Corrosion resistance	Explosion proof design	Conduit options <sup>(1)</sup>	Conduit entries	Instrument connection <sup>(1)</sup>	Features	Recommendations
<b>Rosemount SST with display cover (SR2)</b> 	★★★☆☆	Yes	½-in. NPT (C1); M20 (C2)	1	½-in. NPT (B1); M20 x 1.5 (B2); M24 x 1.5 (B3)	<ul style="list-style-type: none"> <li>■ Allows LCD display use on the transmitter</li> <li>■ Allows for seeing inside the connection head without removing cover</li> <li>■ Fits either DIN A or DIN B size transmitter</li> <li>■ Optional terminal block, external ground screw, or low temperature options also available</li> </ul>	<p>Use with transmitters with displays.</p> <p>Pick this option if an explosionproof connection head is required in a corrosive environment.</p>
<b>Dual entry aluminum (AD1)</b> 	★★☆☆☆	Yes	½-in. NPT (C1), M20 x 1.5 (C2), or ¾-in. NPT (C3)	2	½-in. NPT (B1), M20 x 1.5 (B2), or M24 x 1.5 (B3)	<ul style="list-style-type: none"> <li>■ Includes stainless steel cover chain, cover lock and external ground screw</li> <li>■ Fit DIN B size transmitters</li> <li>■ Optional terminal block also available</li> </ul>	<p>Pick this option if two conduit connections are required.</p>
<b>Dual entry SST (SD1)</b> 	★★★☆☆	Yes	½-in. NPT (C1), M20 x 1.5 (C2), or ¾-in. NPT (C3)	2	½-in. NPT (B1), M20 x 1.5 (B2), or M24 x 1.5 (B3)	<ul style="list-style-type: none"> <li>■ Includes stainless steel cover chain, cover lock, and external ground screw.</li> <li>■ Fit DIN B size transmitters.</li> <li>■ Optional terminal block also available.</li> </ul>	<p>Pick this option if an explosion proof connection head is required in a corrosive environment with two conduit connections.</p>
<b>BUZ aluminum (AF1)</b> 	★★☆☆☆	No	M20 x 1.5 (C2)	1	½-in. NPT (B1) or M24 x 1.5 (B4)	<ul style="list-style-type: none"> <li>■ Smallest connection head available.</li> <li>■ Fit DIN B size transmitters.</li> <li>■ External ground screw included.</li> <li>■ Optional terminal block also available.</li> </ul>	<p>Pick this style for use with flying lead style sensors with removal of the sensor and transmitter as one assembly.</p>
<b>BUZH aluminum (AF3)</b> 	★★☆☆☆	No	M20 x 1.5 (C2)	1	½-in. NPT (B1) or M24 x 1.5 (B4)	<ul style="list-style-type: none"> <li>■ Fit DIN B size transmitters.</li> <li>■ External ground screw included.</li> <li>■ Easy open cover</li> <li>■ Optional terminal block also available.</li> </ul>	<p>Pick this option for terminal block style sensors and transmitters to be mounted together or if two head mount style transmitters are needed.</p>

Head description (code)	Corrosion resistance	Explosion proof design	Conduit options <sup>(1)</sup>	Conduit entries	Instrument connection <sup>(1)</sup>	Features	Recommendations
<b>Aluminum with terminal strip (AT1)<sup>(2)</sup></b> 	★★☆☆	Yes	¾-in. NPT (C3)	1	½-in. NPT (B1)	<ul style="list-style-type: none"> <li>Big connection head that is easy to wire due to shallow terminal strip location.</li> <li>Optional stainless steel cover chain or external ground screw available.</li> </ul>	Pick this option if wire termination is required without the use of a transmitter.
<b>Aluminum with terminal strip and extended cover (AT3)</b> 	★★☆☆	No	¾-in. NPT (C3)	1	½-in. NPT (B1)	<ul style="list-style-type: none"> <li>Big connection head that is easy to wire due to shallow terminal strip location</li> <li>Extended cover provides additional space within the connection head for wires</li> <li>Optional stainless steel cover chain or external ground screw available</li> </ul>	Pick this option if wire termination is required without the use of a transmitter.
<b>Universal 3 entry aluminum junction box (AJ1)</b> 	★★☆☆	Yes	½-in. NPT or M20	2	½-in. NPT	<ul style="list-style-type: none"> <li>Two conduit connection penetrations</li> <li>Optional terminal block, external ground screw, and stainless steel cover chain available</li> </ul>	Pick this option if two conduit connections are required.
<b>Universal 3 entry aluminum junction box with display cover (AJ2)</b> 	★★☆☆	Yes	½-in. NPT or M20	2	½-in. NPT	<ul style="list-style-type: none"> <li>Two conduit connection penetrations</li> <li>Optional terminal block and external ground screw</li> </ul>	Pick this option if two conduit connections are required.

(1) Option codes for the conduit entry and instrument connection are denoted within the parentheses. The conduit entry is the threaded opening between the connection head and the input/output wires. The instrument connection is the threaded opening between the connection head and the sensors.

(2) This connection head with approval option E6 is subject to additional installation restrictions. Contact [Emerson.com/global](http://Emerson.com/global) for additional information.



## Conduit entry

Back to [RTD ordering information](#).

Back to [Thermocouple ordering information](#).

The conduit entry is the threaded opening on the side of the connection head, often connected to wiring conduit. It allows the input/output wires to pass into the connection head.

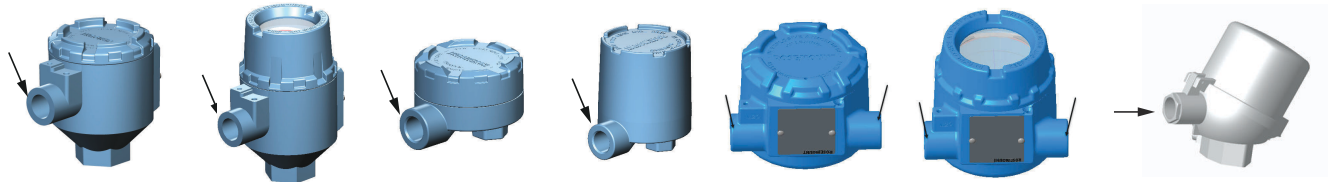

### ½-in. NPT (C1)

U.S. Standard connection thread with a ½-in. diameter

### M20 × 1.5 (C2)

Metric connection thread with a 20 mm diameter and a 1.5 mm fine pitch

### ¾-in. NPT (C3)

U.S. Standard connection thread with a ¾-in. diameter

## Instrument connection

Back to [RTD ordering information](#).

Back to [Thermocouple ordering information](#).

The instrument connection is the threaded opening between the connection head and sensors.

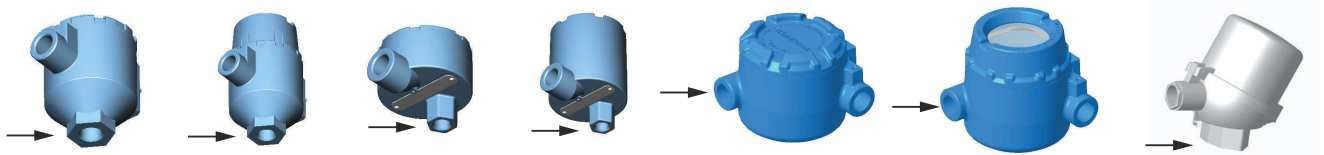

### ½-in. NPT (B1)

U.S. Standard connection thread with a ½-in. diameter

### M20 × 1.5 (B2)

DIN instrument standard connection with a 20 mm diameter

### M24 × 1.5 (B4)

DIN instrument standard connection with a 24 mm diameter



## Conduit cable glands

Back to [RTD ordering information](#).

Back to [Thermocouple ordering information](#).

Conduit cable glands are entry devices that allow for a cable or wires to pass to and from an enclosure while maintaining ingress protection rating. Proper installation of cable glands to the connection head is required to maintain hazardous location approvals and IP rating.

**Table 6: Conduit Cable Gland Specifications**

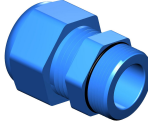
Ordering code	Description	Image	Material	Cable diameter range		IP rating
				For ½-in. NPT and M20	For ¾-in. NPT	
GN1	Ex d, standard cable diameter		Nickel plated brass or 316SST	6.5–12.0 mm (0.26–0.47-in.)	13.0–20.2 mm (0.51–0.80-in.)	IP66/68, NEMA 4X
GN2	Ex d, thin cable diameter			3.2–8.0 mm (0.13–0.32-in.)	10.0–14.3 mm (0.39–0.56-in.)	
GN6	EMV, standard cable diameter			5.0–13.0 mm (0.20–0.51-in.)	13.0–20.2 mm (0.51–0.80-in.)	
GP1	Ex e, standard cable diameter		Polyamide	6.5–12.0 mm (0.26–0.47-in.)	13.0–18.0 mm (0.51–0.71-in.)	
GP2	Ex e, thin cable diameter			5.0–9.0 mm (0.20–0.35-in.)	9.0–16.0 mm (0.35–0.63-in.)	

## Extension type

Back to [RTD ordering information](#).

Back to [Thermocouple ordering information](#).

Sensor assemblies can include extensions of various lengths to distance the transmitter from high process temperatures that may affect the transmitter electronics. Extensions can be a combination of unions, nipples, and/or couplings and can be connected to either a thermowell or the pipe for direct insertion assembly.

### Union style (UA)

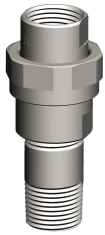

- Adjustable union for ease of orienting the connection head
- All threads will be ½-in. NPT

### Fixed style (FA)



- Lower cost extension type
- Fixed coupling which does not allow for orienting the connection head
- All threads will be ½-in. NPT

### DIN style (PD, PE, PH, PK, PQ, PT, TC, TD, TH, and TN)



- Single piece assembly
- Varied thread lengths as shown in [Table 7](#)

**Table 7: Thread Dimensions**

Code	Tube diameter by wall thickness	Instrument connection thread by thread pitch	Process connection thread by thread pitch
PD	12 x 1.5	M24 x 1.5	M18 x 1.5
PE	12 x 1.5	M24 x 1.5	M20 x 1.5
PH	12 x 1.5	M24 x 1.5	M24 x 1.5
PK	12 x 1.5	M24 x 1.5	G ½ (BSPF)
PQ	15 x 3	M24 x 1.5	M18 x 1.5
PT	15 x 3	M24 x 1.5	M24 x 1.5
TC	12 x 1.5	M24 x 1.5	½-in. NPT
TD	12 x 1.5	M24 x 1.5	¾-in. NPT
TH	12 x 1.5	M24 x 1.5	½-in. (BSPT)
TN	15 x 3	M24 x 1.5	½-in. NPT

## Extension length

Back to [RTD ordering information](#).

Back to [Thermocouple ordering information](#).

Each of the extension types are available in both English/U.S. customary or Metric units. Note the dimension units for each option will be the same as specified earlier in the ordering table (see [Dimension units](#)). When specifying the actual lengths, the following examples can be used.

English/U.S. customary units available from 2.5- to 20-in. (in ½-in. increments):

- 8.5-in. – E085
- 15-in. – E150

Metric available from 65 to 500 mm (in 5 mm increments):

- 80 mm – E080
- 485 mm – E485

### Specify an extension length from an “N” length

If “N” length is known, the adapter/fitting length needs to be subtracted to determine the extension length needed for the assembly.

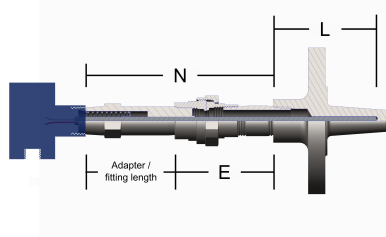

Mounting style	Adapter length <sup>(1)</sup>
SL	2.32 in. (58.93 mm )
SC	1.15 in. (29.21 mm)
SW	2.60 in. (66.04 mm)

Mounting style	Adapter length <sup>(1)</sup>
WA	2.32 in. (58.93 mm)
WC	1.15 in. (29.21 mm )
SA	1.15 in. (29.21 mm)

(1) Adapter sizes assume 1/2-in. thread engagement.

$E = N - (\text{adapter length})$

**Note**

Round the E length to the nearest 5 mm (1/4-in.).

**Selecting an extension**

Aside from ambient temperature variations, the heat from the process is transferred from the thermowell to the transmitter housing. If the process temperature is near or beyond specification limits, consider the use of additional thermowell lagging, an extension nipple, or a remote mounting configuration to isolate the transmitter from the excessive temperatures. Refer to [Figure 19](#) and the corresponding example to approximate an adequate extension length.

**Figure 19: Rosemount Temperature Transmitter Housing Temperature Rise versus Extension Length for a Test Installation**

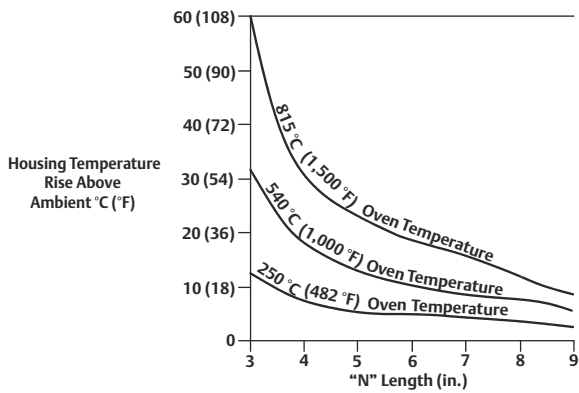

## Lead wire extensions

Back to [RTD ordering information](#).

Back to [Thermocouple ordering information](#).

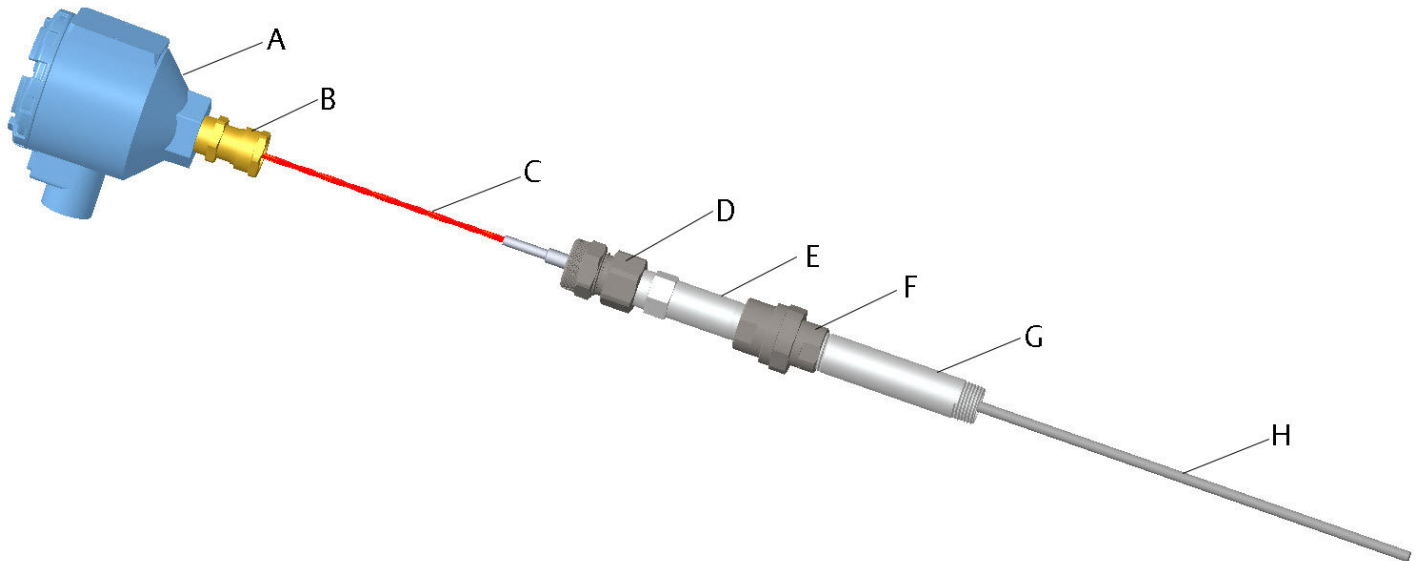

- A. Housing
- B. Lead wire extension cable gland
- C. Lead wire extension
- D. Adapter-mounted cable gland
- E. Mounting style
- F. Union
- G. Extension
- H. Sensor

### Lead wire extensions

Lead wire extensions allow sensors to be installed in processes that a standard sensor may not fit the needs. In hard to reach or elevated process, lead wire extensions enable the transmitter, local indicator and wiring terminations to be graded for easy access. In high temperature installations where ambient temperatures could exceed transmitter environment ratings, lead wire extensions allow the transmitter electronics to be situated further from the process heat sources.

The length (T) of the extension is calculated from the end of the metal sheath to the head mounting fitting. At the end of the length (T), wiring is added to the end to allow for wiring of the sensor. The length (T) is designated in the model string as a four-digit option code.

When ordering in inches, the length can be ordered in 1-in. increments. Here are some examples:

- 72-in. = 72
- 120-in. = 0120

When ordering in centimeters, the length can be ordered in 1 cm increments. Here are some examples:

- 100 cm = 0100
- 270 cm = 0270

The length (T) of the extension is calculated from the end of the metal sheath to the head mounting fitting. At the end of the length (T), wiring is added to the end to allow for wiring of the sensor.

**Lead wires**

RTD lead wires: -24 AWG wire, FEP insulated; color coded per IEC 60751.

Thermocouple lead wires: -24 AWG wire, FEP insulated; color coded per IEC 60584 or ASTM E230.

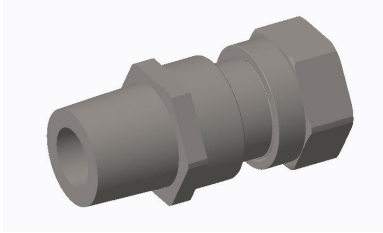
**Cable glands (J1, J2)**

Material: Nickel-plated brass or 316SST

½-in. NPT (J1) or M20 x 1.5 (J2) entries prevents process fluid from entering the assembly, attached to the instrument connection of the housing.

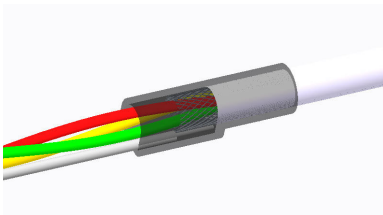
**Drain wire (DW)**

Reduces resistance from ambient or electrical noise.

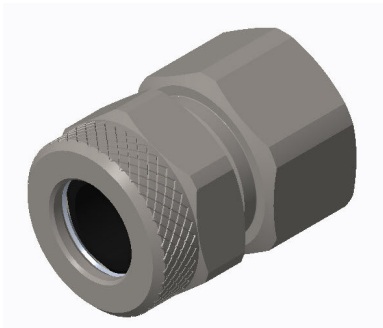
**Adapter-mounted cable gland (F1)**

Material: Zinc plated steel

½-in. NPT entry prevents process fluid from exiting a non-sealed adapter. Example: A spring-loaded adapter.

**Termination style**

**Spade lugs (WB)**

Terminals allow for ease of wiring.

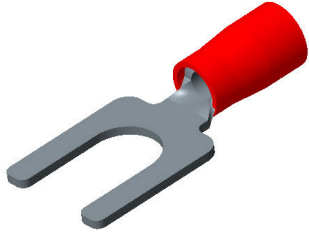

**Bootlace ferrules (WD)**

Ferrules provide ease in wiring and give better electrical contact where needed.

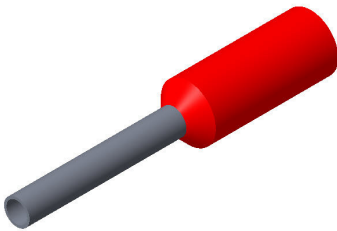

**IP 66/67/68**

Lead wire extension assemblies ordered with options LB, AC or AP options are IP 66/67/68 rated. Assemblies were tested according to IEC 60529.



## Calibration

Back to [RTD ordering information](#).

### Calibration options

Sensor calibration may be required for input to quality systems or for control system enhancement, based on the local regulation requirements for maintaining measurement accuracies. More frequently, it is used to improve the overall temperature measurement performance by matching the sensor to a temperature transmitter.

Sensor matching is available for RTD sensors used with Emerson temperature transmitters where the inherent stability and repeatability of the RTD technology is well established.

### X91Q4: Single point calibration

The X91Q4 option documents the sensor's resistance at a single specified point. A calibration certificate with the resistance value at this point is supplied. Before specifying the point, take careful note of the sensor's temperature limits.

---

#### Note

The X91Q4 option can be ordered and used in conjunction with the X8Q4, V20Q4 - V27Q4 options. However, when ordering in conjunction with other calibration option codes, only specify one instance of "Q4".

---

### Callendar-Van Dusen constants

Significant temperature measurement accuracy improvement can be attained using a temperature sensor that is matched to a temperature transmitter. This matching process entails teaching the temperature transmitter the relationship between resistance and temperature for a specific RTD sensor. This relationship, approximated by the Callendar-Van Dusen equation, is described as:

$R_t = R_0 + R_0\alpha[t - \delta(0.01t - 1)(0.01t) - \beta(0.01t - 1)(0.01t)^3]$ , where:

$R_t$  = resistance (ohms) at temperature  $t$  (°C)

$R_0$  = sensor-specific constant (resistance at  $t = 0$  °C)

$\alpha$  = sensor-specific constant

$\delta$  = sensor-specific constant

$\beta$  = sensor-specific constant (0 at  $t > 0$  °C, 0.11 at  $t < 0$  °C)

The exact values for  $R_0$ ,  $\alpha$ ,  $\delta$ ,  $\beta$ , – known as Callendar-Van Dusen (CVD) constants – are specific to each RTD sensor, and are established by testing each individual sensor at various temperatures.

The calibration temperature values using the CVD equation are divided into two major temperature areas: above 0 °C and below 0 °C. The calibration for the temperature range is obtained from the following formula:

$$R_t = R_0 \left\{ 1 + a \left[ t - d \left( \frac{t}{100} \right) \left( \frac{t}{100} - 1 \right) \right] \right\}$$

Note that this is a modification of the fourth-order CVD equation where  $b = 0$  for temperatures greater than 0 °C. Since this modified equation is a second-order equation, at least three distinct temperature values are needed in order to curve fit the behavior of the RTD. For the temperature range from 0 to 100 °C, only these two end points are used, and an approximation is made to render the constants.

Once the sensor-specific constants are entered, the transmitter uses them to generate a custom curve to best describe the relationship between resistance and temperature for the particular sensor and transmitter system. Matching a Rosemount 214C temperature sensor to an Emerson temperature transmitter typically results in a three- or four-fold improvement in temperature measurement accuracy for the measurement point. This substantial system accuracy improvement is realized as a result of the transmitter's ability to use the sensor's actual resistance-vs.-temperature curve instead of an ideal curve.

---

#### Note

An RTD ordered with the V option is shipped with CVD constants only; while resistance data for several temperature points is included, it does not include a full calibration table.

---

**V20Q4 - V27Q4: Calibration with A, B, C, and Callendar-Van Dusen constants to specific temperature ranges**

Rosemount 214C sensors can be ordered with an option (i.e. V20Q4...V27Q4), that provides Callendar-Van Dusen constants and are shipped with the sensor. When you order this option, the values of all four sensor-specific constants are physically attached to each sensor with a wire-on tag. Emerson temperature transmitters have a unique, built-in sensor matching capability. To use this capability, the four sensor-specific constants are programmed into the transmitter at the factory by ordering a C2 option on the transmitter, or easily entered and changed in the field using a Field Communicator or AMS Device Manager. When these values are entered into an Emerson temperature transmitter, the sensor and transmitter become matched.

For applications requiring the increased accuracy obtainable through a matched sensor and transmitter, order the appropriate "V" option. To ensure optimal performance, select a "V" option such that the sensor's range of actual operation is between the minimum and maximum calibration points.

Option Code	Temperature Range		Calibration Points	
	°F	°C	°F	°C
V20Q4	32 to 212	0 to 100	32	0
			212	100
V21Q4	32 to 392	0 to 200	32	0
			212	100
			392	200
V22Q4	32 to 842	0 to 450	32	0
			212	100
			842	450
V23Q4	32 to 1112	0 to 600	32	0
			212	100
			1112	600
V24Q4	-58 to 212	-50 to 100	-58	-50
			32	0
			212	100
V25Q4	-58 to 392	-50 to 200	-58	-50
			32	0
			212	100
			392	200
V26Q4	-58 to 842	-50 to 450	-58	-50
			32	0
			212	100
			842	450
V27Q4	-321 to 1112	-196 to 600	-321	-196
			32	0
			212	100
			1112	600

**Note**

The uncertainty of each measurement is ±0.1 °C for temperatures equal to or less than 100 °C and ±0.3 °C for temperatures greater than 100 °C.

**X8Q4: Calibration with A, B, C, and Callendar-Van Dusen constants to a custom specified temperature range**

When an RTD with the X8Q4 option is ordered, a temperature range over which the sensor is to be calibrated must be specified. Before specifying the range, take careful note of the sensor's temperature limits.

## MID Custody Transfer Calibration

**MID Measurement Instrument Directive (MD1, MD2, MD3)**

Rosemount 214C Temperature Sensor has been certified to meet the European Union Measurement Instrument Directive (MID) for custody transfer metering of liquids and gases. Choosing Rosemount temperature for a MID solution ensures that critical temperature measurement equipment will meet high expectations for unmatched system accuracy and reliability.

- MD1** Custody Transfer Calibration (-196 °C to 0 °C); only available with sensor type RW and sensor accuracy B1; 4-wire input required; only available on 3144P transmitter with D4 (custody transfer option); minimum sensor length 200 mm (7.75 in) required.
- MD2** Custody Transfer Calibration (-50 °C to 100 °C); only available with sensor type RT, RH or RW; 4 wire input required; only available on 3144P, 644, or 248 transmitters with D4 (custody transfer option); minimum sensor length 200 mm (7.75 in) required.
- MD3** Custody Transfer Calibration (50 °C to 200 °C); only available with sensor type RT, RH or RW; 4 wire input required; only available on 3144P with D4 (custody transfer option); minimum sensor length 210 mm (8.25 in) required.

## Calibration Certificate and Primary Verification Certificate

- QG** This is also referred to as the GOST Calibration Certificate because the GOST norm is the basis of the standard. The following actions were completed to get this certification.
  - Pattern Approval (a Russian GOST approval) on 214 base model
  - Calibration procedure and certificate provided for the base model
    - Validation requires calibration options with the QG option.  
Example: For sensors any V-option, X8 or X9
    - Certified lab worked directly with Russian authorities and issued resulting certificate

## Ground screw (G1)

Back to [RTD ordering information](#).

Back to [Thermocouple ordering information](#).

The external screw allows the users to ground wires to the connection head. Ground screw is 316 SST material.

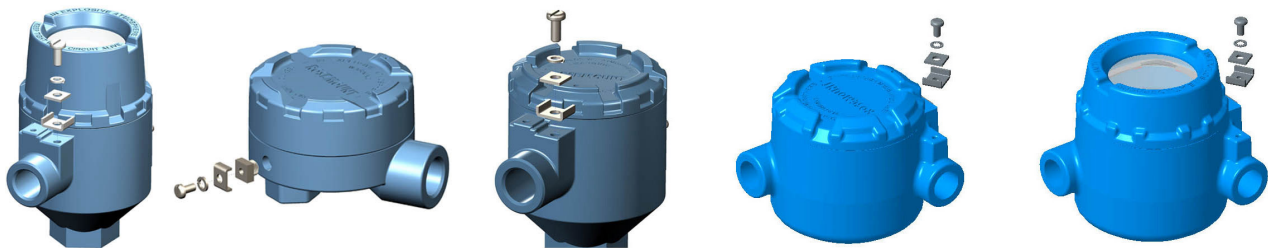

### Cover chain (G3)

Back to [RTD ordering information](#).

Back to [Thermocouple ordering information](#).

The cover chain keeps the cover connected to the connection head when disassembled. Cover chain is 304 SST material.



### Extension Ring (G6)

Back to [RTD ordering information](#).

Back to [Thermocouple ordering information](#).

This option allows the sensor to have an extension that allows the mounting of two transmitters in the sensor head.

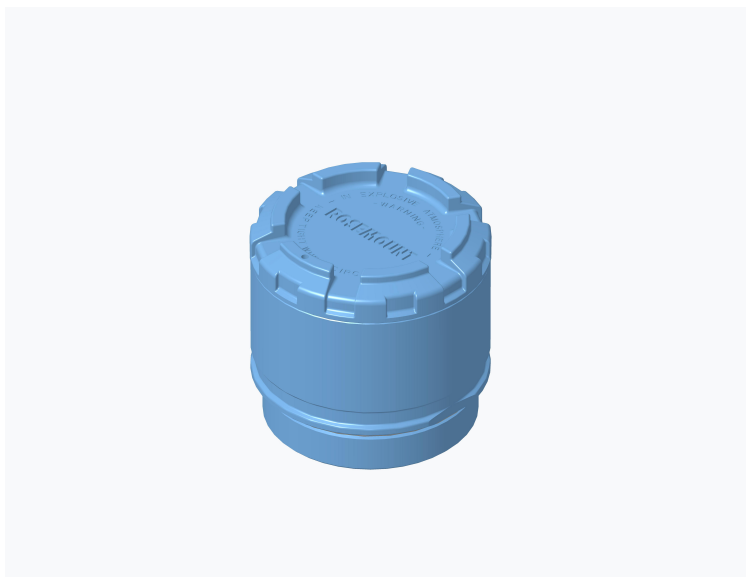



## Terminal block (TB)

Back to [Thermocouple ordering information](#).

The terminal block is installed in the connection head and the sensor lead wires are terminated to one side of the terminal block. Terminal blocks are typically used when mounting remote transmitters.



## Low temperature housing (LT, BR)

Back to [RTD ordering information](#).

Back to [Thermocouple ordering information](#).

Selecting one of these options allows the connection head to be compatible to lower temperatures.

<b>LT:</b>	-60 °F (-51 °C)
<b>BR:</b>	-76 °F (-60 °C)

## Transmitter assembled to sensor (XA, XC)

Back to [RTD ordering information](#)

Back to [Thermocouple ordering information](#)

### XA

This option is selected when a sensor is ordered with a transmitter. This option code ensures the sensor is threaded into the connection head and torqued for a process-ready installation, with the sensor wired to the terminal.

### XC

This option is selected when a sensor is ordered with a transmitter. This option code ensures the sensor is threaded into the connection head, but only hand tightened, and manual wiring of the sensor to the terminal is required.

---

### Note

XC code does not meet hazardous location approval requirements. Refer to Rosemount 214C [Quick Start Guide](#) for proper installation.

---

## Thermowell assembled to sensor (XW, XT)

Back to [RTD ordering information](#).

Back to [Thermocouple ordering information](#).

### XW

This option is selected when a sensor is ordered with the Rosemount 114C Thermowell. It ensures the sensor is threaded into the thermowell and torqued for a process-ready installation.

### XT

This option is selected when a sensor is ordered with the Rosemount 114C Thermowell. It ensures the sensor is threaded into the thermowell, but only hand-tightened.

---

### Note

XT code does not meet hazardous location approval requirements. Refer to Rosemount 214C [Quick Start Guide](#) for proper installation.

---

## Extended product warranty (WR3, WR5)

Back to [RTD ordering information](#).

Back to [Thermocouple ordering information](#).

The extended product warranty options are available in three- or five-year coverage plans. In the model string, order option codes WR3 for a three-year extended warranty or WR5 for a five-year warranty. This coverage is an extension of the manufacturer's limited warranty and states that the goods manufactured or services provided by seller will be free from defects in materials or workmanship under normal use and care until the expiration of the applicable warranty period.

## Additional RTD specifications

---

### Note

All specifications in this section apply to all RTDs unless noted otherwise. All RTDs meet and/or exceed type and routine tests for sensors/thermometers per IEC 60751:2008.

---

## Insulation resistance

1000 M $\Omega$  minimum insulation resistance when measured at 500 VDC at room temperature.

## Insulation resistance at elevated temperature

Insulation resistance at elevated temperatures for sensor types RT, RH, and RW are tested and meet requirements according to IEC 60751:2008 6.5.1.

## Time response

Sensor response time tested in flowing water according to IEC 60751:2008 6.5.2.

Sensor type RT: T50 average = 8.5 seconds; T90 average = 22.9 seconds

Sensor type RH: T50 average = 9.15 seconds; T90 average = 24.1 seconds

Sensor type RW: T50 average = 9.0 seconds; T90 average = 24.4 seconds

## Stability

Stability at upper temperature limit tested and meets requirements according to IEC 60751:2008 6.5.3.

## Effects of temperature cycling

Effect of temperature cycling tested and meets requirements according to IEC 60751:2008 6.5.5.

## Hysteresis

Effect of hysteresis tested and meets requirements according to IEC 60751:2008 6.5.6.

## Self heating

Self-heating tested and meets requirements according to IEC 60751:2008 6.5.7.

## Process immersion

Minimum immersion depth tested according to IEC 60751:2008 6.5.8.

Sensor type RT, single: Minimum immersion depth = 30 mm

Sensor type RT, dual: Minimum immersion depth = 45 mm

Sensor type RH, single and dual: Minimum immersion depth = 40 mm

Sensor type RW, single and dual: Minimum immersion depth = 50 mm

## Vibration limits

Vibration tested according to IEC 60751:2008 6.6.4.

Sensor type RT and RH: Meets 3 g vibration between 20 and 500 Hz for 150 hours.

Sensor type RW: Meets 1 g vibration between 20 and 500 Hz for 150 hours.



## Functional specifications

<b>Power</b>	Overvoltage Category I
<b>Environmental</b>	Pollution Degree 4

## Additional thermocouple specifications

### Note

All specifications in this section apply to all thermocouple types unless noted otherwise. All thermocouples meet and/or exceed type and routine tests for sensors/thermometers per IEC 61515:2016.

## Insulation resistance

1000 M $\Omega$  minimum insulation resistance when measured at 500 VDC at room temperature.

## Time response

Sensor response time tested in flowing water according to IEC 61515:2016 5.3.2.8.

Grounded: T50 average = 1.9 seconds; T90 average = 4.0 seconds

Ungrounded: T50 average = 2.8 seconds; T90 average = 7.3 seconds

## Process immersion

Minimum immersion depth tested according to IEC 60751:2008 6.5.8.

Grounded thermocouples: Minimum immersion depth = 5 mm

Ungrounded thermocouples: Minimum immersion depth = 10 mm

## Continuity

Electrical continuity and polarity are tested and meet requirements according to IEC 61515:2016 5.3.2.

## Functional specifications

<b>Power</b>	Overvoltage Category I
<b>Environmental</b>	Pollution Degree 4





For more information: [Emerson.com/global](https://emerson.com/global)

©2024 Emerson. All rights reserved.

Emerson Terms and Conditions of Sale are available upon request. The Emerson logo is a trademark and service mark of Emerson Electric Co. Rosemount is a mark of one of the Emerson family of companies. All other marks are the property of their respective owners.

**ROSEMOUNT™**

