

Rosemount™ 2410 Tank Hub

for tank gauging systems



Handles communication between tank devices and the control room

- Save installation cost with the bus-powered intrinsically safe 2-wire Tankbus
- Calculate average temperature, observed density, and strapping table based volume
- Simplify start-up with tank device auto-configuration
- Many communication possibilities, including Modbus®, IEC 62591 (*WirelessHART*®), and emulation of other vendors' protocols
- Two configurable alarm output relays
- Certified SIL 2 or SIL 3 (relay or analog output)

Rosemount 2410 Tank Hub for single or multiple tanks

Efficient communication between tanks and control room

Rosemount 2410 handles communication between the field devices and the control room. It also provides IEC 61508 certified SIL 2 and SIL 3 overfill prevention alarm outputs for the Rosemount Tank Gauging System. The device is available in three versions, for single tanks, multiple tanks, and functional safety/SIS applications (SIL 2 single tank).

Figure 1: Tank Gauging System Overview

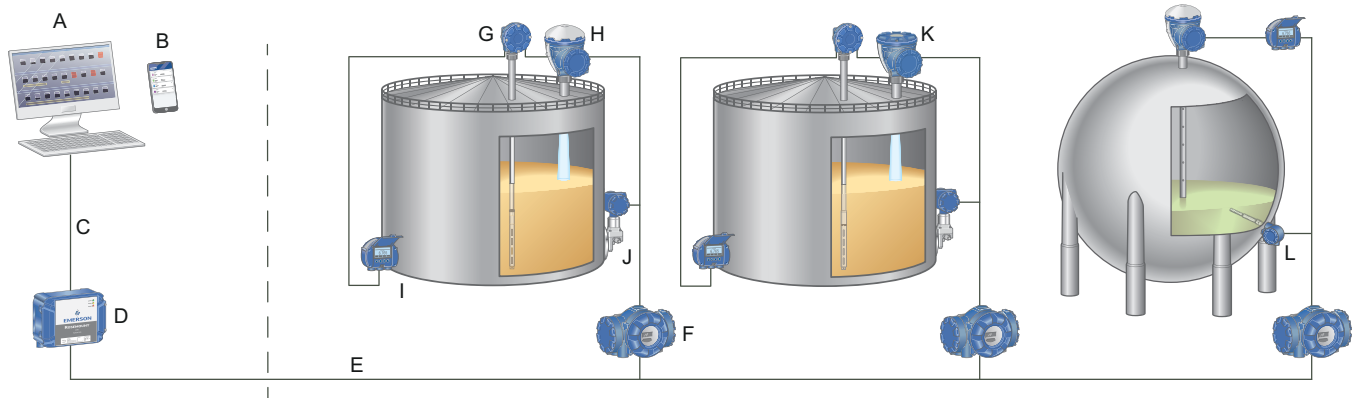

- A. Rosemount TankMaster Inventory Management
- B. Rosemount TankMaster Mobile Inventory Management
- C. Modbus® RTU/TCP
- D. Rosemount 2460 System Hub
- E. Tankbus
- F. Rosemount 2410 Tank Hub
- G. Rosemount 2240S Multi-input Temperature Transmitter with Rosemount 765 Multiple Spot Temperature and Water Level Sensor
- H. Rosemount 5900S Radar Level Gauge
- I. Rosemount 2230 Graphical Field Display
- J. Rosemount 3051S Pressure Transmitter
- K. Rosemount 5900C Radar Level Gauge
- L. Rosemount 644 Temperature Transmitter with Rosemount 65, 114C, or 214C Single Point Temperature Sensor

Contents

| | |
|--|----|
| Rosemount 2410 Tank Hub for single or multiple tanks..... | 2 |
| Ordering information..... | 7 |
| Specifications..... | 21 |
| Specifications for Emerson Wireless 775 THUM Adapter Assembly..... | 36 |
| Product certifications..... | 38 |
| Product certifications for Emerson 775 THUM Adapter..... | 54 |
| Dimensional drawings..... | 59 |

Tankbus communication

The Rosemount 2410 Tank Hub communicates with and powers the devices on one or several tanks via the Tankbus.

The Tankbus complies with Fieldbus Intrinsically Safe Concept (FISCO) FOUNDATION™ Fieldbus.

By using FISCO, there is no need to take entity parameters into consideration. It makes it easy to connect devices.

In addition, the available power from a FISCO power supply is higher compared to a conventional entity power supply. This enables the connection of more devices on the Tankbus.

Auto-configure tank devices

The Rosemount 2410 supports the auto-configuration of the Tankbus devices within the Rosemount Tank Gauging System. It acts as a FOUNDATION Fieldbus master on the Tankbus, which means it identifies and auto-addresses field devices in the network, manages communication, and supervises the status of all connected devices. It also includes extensive built-in diagnostics.

Data handling and calculation

Rosemount 2410 collects measurement values such as level, temperature, and pressure.

It calculates average temperature, observed density, and strapping table based volume.

Such data can be presented on the optional integrated back-lit display, a separate Rosemount 2230 Graphical Field Display, and can be sent to a host system.

Improve data security

All tank hubs have a software write-protection function.

In addition, the Rosemount 2410 with display option is equipped with a hardware write-protection switch.

Control room communication

Rosemount 2410 has slots for two independent communication boards (primary and secondary fieldbus) for TRL2 Modbus, RS485 Modbus, emulation, and wireless communication.

Power supply with built-in cable terminator

Rosemount 2410 supplies power to the units on the Tankbus.

It is equipped with an integrated FISCO-certified IS barrier, has power conditioner functionality, and built-in electronics for bus termination. A terminator at each end of the Tankbus ensures that the fieldbus network has proper signal levels.

All these features enable the easy setup of the Rosemount Tank Gauging System.

Analog input/output

The Rosemount 2410 Tank Hub can be ordered with:

- An analog input
- An analog output for connection to a host system
- The analog output is available as certified SIL 2 for overfill prevention or dry-run protection. Suitable for connection to an automatic overfill prevention system.

Emulate gauges from other vendors

Rosemount 2410 enables replacement of old mechanical/servo gauges with modern Rosemount devices.

When an old gauge from another vendor is replaced with a tank hub connected to a Rosemount field device, the tank hub will act just like the replaced gauge.

By using the other vendor's field and control room communication protocol together with modern Rosemount tank gauging devices, the legacy system can be modernized step-by-step. The legacy system can be upgraded while tanks are in operation, and the existing wiring can be re-used.

Figure 2: Emulation

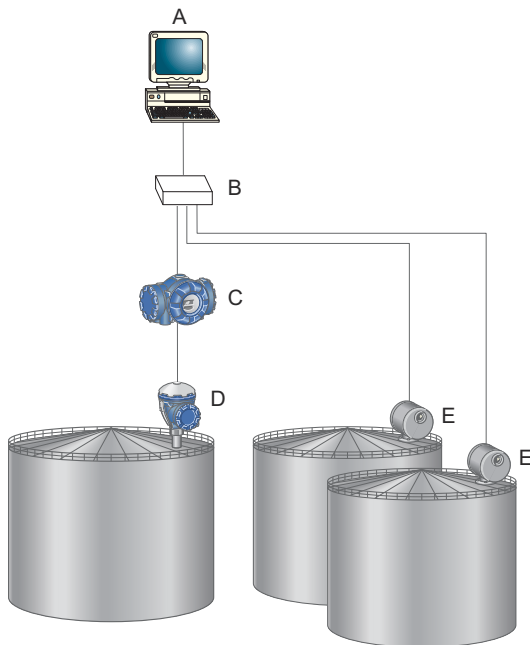

- A. Existing host system from other vendor
- B. Existing data polling unit
- C. Rosemount 2410 Tank Hub
- D. Rosemount 5900S Radar Level Gauge
- E. Gauges from other vendor in an existing system

Rosemount 2410 and Rosemount 5900S replacing a servo gauge in a system from another vendor. Rosemount devices are seamlessly integrated into the existing system.

Output relay functionality

Rosemount 2410 can be equipped with two solid-state relays that can be configured to be controlled by level, temperature, and water level. The output is normally connected to an external system for alarm indication or process control.

These relays are user-configurable for normally open or closed operation. They can be either certified SIL 2, and used for overfill prevention via an emergency shutdown system (ESD), or non-SIL.

A third separate relay dedicated for SIL 3 overfill functionality can also be included. This relay is activated both if the alarm level is reached and/or if a device malfunction occurs. It operates in a normally closed mode, and the output can be connected to an ESD system.

Rosemount 2410:SIS Tank Hub for SIS applications (SIL 2)

The Rosemount 2410:SIS Tank Hub (Tankbus: number of tanks option code F) is designed for functional safety/SIS applications (SIL 2 single tank):

- Supports one Rosemount 5900 SIL 2 safety level device for overfill or dry-run protection.
- Typically used in combination with Rosemount 2410 single tank hub for an independent SIL certified protection layer.

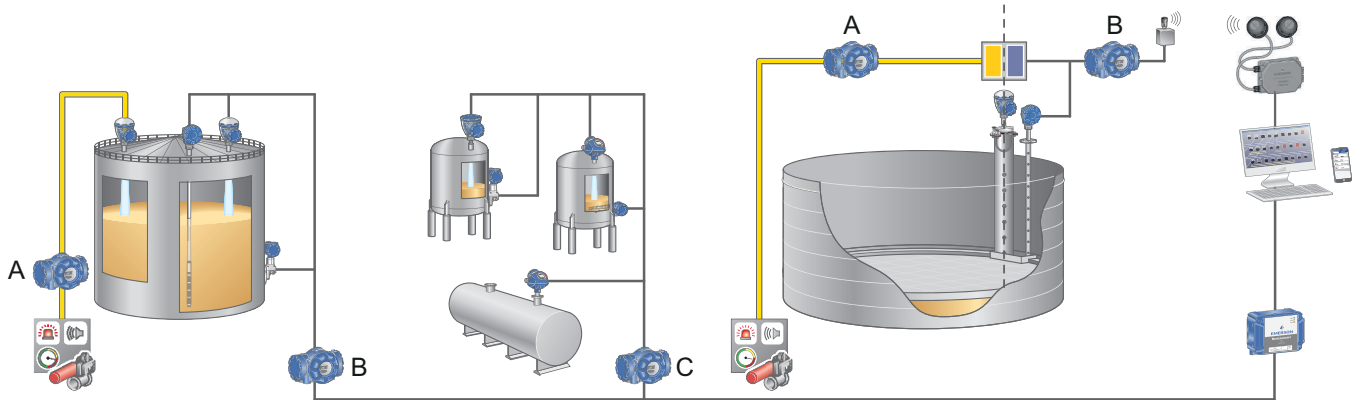

- A. Rosemount 2410:SIS Tank Hub
- B. Rosemount 2410 Tank Hub for single tanks
- C. Rosemount 2410 Tank Hub for multiple tanks

Wireless communication

The Emerson Wireless 775 THUM™ Adapter acts as a wireless data link between the tank hub and an Emerson Wireless Gateway in a WirelessHART® field network. Available tank data such as level, temperature, etc. are transmitted via the wireless THUM Adapter.

Figure 3 shows the Rosemount 2410 Tank Hub connected to an Emerson Wireless 775 THUM Adapter assembly with integrated junction box.

Figure 3: Wireless Communication



Access information when you need it with asset tags

Newly shipped devices include a unique QR code asset tag that enables you to access serialized information directly from the device. With this capability, you can:

- Access device drawings, diagrams, technical documentation, and troubleshooting information in your MyEmerson account
- Improve mean time to repair and maintain efficiency
- Ensure confidence that you have located the correct device
- Eliminate the time-consuming process of locating and transcribing nameplates to view asset information

Ordering information

Model codes

Model codes contain the details related to each product. Exact model codes will vary; an example of a typical model code is shown in [Figure 4](#).

Figure 4: Model Code Example

| | |
|----------------------------|--------------|
| <u>2410SFR0321PSE1RA1P</u> | <u>WR3ST</u> |
| 1 | 2 |

1. Required model components (choices available on most)
2. Additional options (variety of features and functions that may be added to products)

Rosemount 2410 Tank Hub



The Rosemount 2410 handles data communication between field devices and the control room, and is available in two versions for single or multiple tanks. Control room communication options include Modbus®, IEC 62591 (*WirelessHART®* protocol) and emulation of other vendors' protocols. The tank hub also feeds power to Rosemount field devices on the FISCO compliant intrinsically safe Tankbus.

[VIEW PRODUCT >](#)

Required model components

Model

| Code | Description |
|------|-------------|
| 2410 | Tank Hub |

Tankbus: number of tanks

| Code | Description |
|------------------|---|
| S ⁽¹⁾ | Single tank |
| M ⁽²⁾ | Multiple tanks (up to ten level devices per tank hub) |

(1) Supports one Rosemount 5900S 2-in-1 gauge or up to two Rosemount 5900 standard gauges.

(2) Up to five Rosemount 5300, up to 10 Rosemount 5408 per tank hub.

Tankbus: power and communication

| Code | Description |
|------|--|
| F | Intrinsically safe FOUNDATION™ Fieldbus (IEC 61158) power supply |

Primary fieldbus

| Code | Description |
|------------------|---|
| R | TRL2 Modbus |
| 4 | RS485 Modbus |
| E | Enraf® Bi-phase Mark GPU |
| H ⁽¹⁾ | Whessoe WM 550/660 (digital current loop) |
| G ⁽¹⁾ | GPE 31422/31423 (digital current loop) |
| U ⁽¹⁾ | Sakura (MDP/V1) |
| T ⁽¹⁾ | Tokyo Keiso |
| B ⁽¹⁾ | Analog output 4-20 mA/HART®, passive (non-IS) |
| 7 ⁽¹⁾ | Analog input 4-20 mA/HART®, passive (non-IS) |

(1) Requires Secondary fieldbus code W.

Secondary fieldbus

| Code | Description |
|---------------------|--|
| R ⁽¹⁾ | TRL2 Modbus |
| E ⁽¹⁾ | Enraf® Bi-phase Mark GPU |
| W ⁽²⁾⁽³⁾ | WirelessHART® (IEC 62591) connectivity (IS) |
| L ⁽¹⁾ | L&J Tankway Slave 1500 XL/MCG 2000 |
| V ⁽¹⁾ | Varec® Mark/Space GT 1800/1900 |
| H ⁽¹⁾ | Whesoe WM 550/660 (digital current loop) |
| G ⁽¹⁾ | GPE 31422/31423 (digital current loop) |
| U ⁽¹⁾ | Sakura (MDP/V1) |
| T ⁽¹⁾ | Tokyo Keiso |
| C ⁽³⁾⁽⁴⁾ | Analog output 4-20 mA/HART, active (IS) |
| A ⁽³⁾⁽⁴⁾ | Analog output 4-20 mA/HART, active (non-IS) |
| D ⁽⁴⁾ | Analog output 4-20 mA/HART, passive (IS) |
| B ⁽⁴⁾ | Analog output 4-20 mA/HART, passive (non-IS) |
| 8 ⁽³⁾⁽⁴⁾ | Analog input 4-20 mA/HART, active (IS) |
| 6 ⁽³⁾⁽⁴⁾ | Analog input 4-20 mA/HART, active (non-IS) |
| 9 ⁽⁴⁾ | Analog input 4-20 mA/HART, passive (IS) |
| 7 ⁽⁴⁾ | Analog input 4-20 mA/HART, passive (non-IS) |
| 0 ⁽⁴⁾ | None |
| F ⁽⁴⁾ | None, ready for upgrade of secondary bus |

(1) Requires Primary fieldbus code R or 4.

(2) Requires a separate Emerson Wireless 775 THUM Adapter (not included, to be ordered as a separate item).

(3) Power-supply integrated. Maximum Tankbus current reduced to 200 mA.

(4) Requires Primary fieldbus code R, 4 or E.

Safety certification (SIS)

| Code | Description |
|------------------------|---|
| 3 ⁽¹⁾⁽²⁾ | Certified IEC 61508 SIL 3 (Using relay 1xSPST, solid-state. Certification is valid only when connected to a safety-certified Rosemount 5900 according to reference manual). |
| S ⁽²⁾⁽³⁾ | Certified IEC 61508 SIL 2 (using analog or relay output) |
| F ⁽²⁾⁽³⁾⁽⁴⁾ | None, ready for upgrade of safety certification (SIS) |
| 0 | None |

(1) Requires Secondary fieldbus code 0, or Secondary fieldbus code W, C, D, 8, 9, and Primary fieldbus code 4.

(2) Requires Number of tanks code S.

(3) Requires Relay output code 2 or 1, or Primary fieldbus Code B, or Secondary fieldbus code A, B, C or D for SIL 2 (Safety certification code S).

(4) Requires Secondary fieldbus code 0 or F for SIL3 (Safety certification code 3).

Relay output

| Code | Description |
|------|---|
| 2 | 2xSPST, solid-state |
| 1 | 1xSPST, solid-state |
| F | None, ready for upgrade of relay output |
| 0 | None |

Integral display

| Code | Description |
|------|-------------|
| 1 | LCD |
| 0 | None |

Power supply

| Code | Description |
|------|---|
| P | Extended input range: 48-240 Vac at 50/60 Hz, and 24-48 Vdc |

Firmware

| Code | Description |
|------|-------------|
| S | Standard |

Hazardous location certification

| Code | Description |
|-------------------|--|
| E1 | ATEX Flameproof |
| E7 | IECEX Flameproof |
| E5 | FM-US Explosion-proof |
| E6 | FM-Canada Explosion-proof |
| E4 | Japan Flameproof |
| E2 | INMETRO Flameproof (Brazil) |
| EP ⁽¹⁾ | KC Flameproof (South Korea) |
| EW | CCOE/PESO Flameproof Certification (India) |
| EM | Technical Regulations Customs Union (EAC) Flameproof |
| NA | No hazardous location certification |

(1) Requires Custody transfer type approval code R or O.

Custody transfer type approval

Requires a Rosemount 5900S Radar Level Gauge with corresponding Custody transfer type approval.

| Code | Description |
|------------------|---|
| R | OIML R85 E 2008 performance certification |
| A | CMI (Czech Republic W&M approval) |
| B | NMI (Australia) |
| C | PTB (German W&M approval) |
| E | TJA (Estonia W&M approval) |
| G | GUM (Poland) |
| I | Ministero (Italy) |
| K ⁽¹⁾ | GOST (Kazakhstan) |
| L | LNE (France) |
| M | BMS (Belgium W&M) |
| N | NMi (the Netherlands W&M approval) |
| O | ONML (Algeria) |
| Q | IPQ (Portugal) |
| S ⁽¹⁾ | GOST (Russia) |
| T | ANM (Tunisia) |
| W | METAS (Switzerland W&M approval) |
| Y | Justervesenet (Norway W&M approval) |
| 0 | None |

(1) Requires Hazardous location certification code E1.

Housing

| Code | Description |
|------|---|
| A | Aluminum (polyurethane-covered), IP 66/67 |

Cable/conduit connections

| Code | Description | Includes |
|------------------|---|---|
| 1 | ½-14 NPT and ¾-14 NPT, female thread | <ul style="list-style-type: none"> ■ 1 pcs ½-14 NPT plug ■ 2 pcs ¾-14 NPT plugs |
| 2 | M20 x 1.5 and M25 x 1.5 adapters, female thread | <ul style="list-style-type: none"> ■ 1 pcs ½-14 NPT plug ■ 2 pcs ¾-14 NPT plugs ■ 4 pcs ½-14 NPT->M20 x 1.5 adapters ■ 2 pcs ¾-14 NPT->M25 x 1.5 adapters |
| G ⁽¹⁾ | Metal cable glands (½-14 and ¾-14 NPT) | <ul style="list-style-type: none"> ■ 1 pcs ½-14 NPT plug ■ 2 pcs ¾-14 NPT plugs ■ 4 pcs ¾-14 NPT cable glands ■ 2 pcs ½-14 NPT cable glands |
| E | eurofast® male connector | <ul style="list-style-type: none"> ■ 1 pcs male connector |
| M | minifast® male connector | <ul style="list-style-type: none"> ■ 1 pcs ½-14 NPT plug ■ 2 pcs ¾-14 NPT plugs |

(1) Minimum temperature -20 °C (-4 °F). ATEX/IECEX Ex e approved.

Mechanical installation

| Code | Description |
|------|---|
| W | Mounting kit for wall installation |
| P | Mounting kit for both wall and pipe installation (1-2-in. vertical or horizontal pipes) |

Additional options**Safety certificate**

Requires Safety certification (SIS) code S or 3.

| Code | Description |
|------|--------------------------------------|
| QT | IEC 61508 certificate and FMEDA data |

Overfill protection approval

Requires Safety certification (SIS) code 3, or Relay output code 1 or 2.

| Code | Description |
|------|---|
| U1 | TÜV/DIBt WHG approval for overfill protection |
| U2 | SVTI approval for overfill protection (Switzerland) |

Tag plate

| Code | Description |
|------|--|
| ST | Engraved SST tag plate (tag shall be submitted with order) |

Extended product warranty

Rosemount extended warranties have a limited warranty of three or five years from date of shipment.

| Code | Description |
|-------------|-------------------------|
| WR3 | 3-year limited warranty |
| WR5 | 5-year limited warranty |

Rosemount 2410:SIS Tank Hub



The Rosemount 2410:SIS Tank Hub (Tankbus: number of tanks option code F) is designed for functional safety/SIS applications (SIL 2 single tank).

[VIEW PRODUCT >](#)

Required model components

Model

| Code | Description |
|------|-------------|
| 2410 | Tank Hub |

Tankbus: number of tanks

| Code | Description |
|------------------|--|
| F ⁽¹⁾ | Functional safety / SIS applications (SIL 2 single tank) |

⁽¹⁾ Supports one Safety Certified Rosemount 5900 level gauge.

Tankbus: power and communication

| Code | Description |
|------|--|
| F | Intrinsically safe FOUNDATION™ Fieldbus (IEC 61158) power supply |

Primary fieldbus

| Code | Description |
|------------------|---|
| R | TRL2 Modbus |
| 4 | RS485 Modbus |
| B ⁽¹⁾ | Analog output 4-20 mA/HART®, passive (non-IS) |

⁽¹⁾ Requires Secondary fieldbus code W.

Secondary fieldbus

| Code | Description |
|---------------------|--|
| R ⁽¹⁾ | TRL2 Modbus |
| W ⁽²⁾⁽³⁾ | WirelessHART® (IEC 62591) connectivity (IS) |
| C ⁽¹⁾⁽³⁾ | Analog output 4-20 mA/HART, active (IS) |
| A ⁽¹⁾⁽³⁾ | Analog output 4-20 mA/HART, active (non-IS) |
| D ⁽¹⁾ | Analog output 4-20 mA/HART, passive (IS) |
| B ⁽¹⁾ | Analog output 4-20 mA/HART, passive (non-IS) |

| Code | Description |
|------------------|--|
| 0 ⁽¹⁾ | None |
| F ⁽¹⁾ | None, ready for upgrade of secondary bus |

(1) Requires Primary fieldbus code R or 4.

(2) Requires a separate Emerson Wireless 775 THUM Adapter (not included, to be ordered as a separate item).

(3) Power-supply integrated. Maximum Tankbus current reduced to 200 mA.

Safety certification (SIS)

| Code | Description |
|------------------|--|
| S ⁽¹⁾ | Certified IEC 61508 SIL 2 (using analog or relay output) |

(1) Requires Relay output code 2 or 1, or Primary fieldbus Code B, or Secondary fieldbus code A, B, C or D for SIL 2 (Safety certification code S).

Relay output

| Code | Description |
|------|---|
| 2 | 2xSPST, solid-state |
| 1 | 1xSPST, solid-state |
| F | None, ready for upgrade of relay output |
| 0 | None |

Integral display

| Code | Description |
|------|-------------|
| 1 | LCD |
| 0 | None |

Power supply

| Code | Description |
|------|---|
| P | Extended input range: 48-240 Vac at 50/60 Hz, and 24-48 Vdc |

Firmware

| Code | Description |
|------|-------------|
| S | Standard |

Hazardous location certification

| Code | Description |
|------|---------------------------|
| E1 | ATEX Flameproof |
| E7 | IECEx Flameproof |
| E5 | FM-US Explosion-proof |
| E6 | FM-Canada Explosion-proof |
| E4 | Japan Flameproof |

| Code | Description |
|-------------------|--|
| E2 | INMETRO Flameproof (Brazil) |
| EP ⁽¹⁾ | KC Flameproof (South Korea) |
| EW | CCOE/PESO Flameproof Certification (India) |
| EM | Technical Regulations Customs Union (EAC) Flameproof |
| NA | No hazardous location certification |

(1) Requires Custody transfer type approval code 0.

Custody transfer type approval

Requires a Rosemount 5900S Radar Level Gauge with corresponding Custody transfer type approval.

| Code | Description |
|------|-------------|
| 0 | None |

Housing

| Code | Description |
|------|---|
| A | Aluminum (polyurethane-covered), IP 66/67 |

Cable/conduit connections

| Code | Description | Includes |
|------------------|---|---|
| 1 | ½-14 NPT and ¾-14 NPT, female thread | <ul style="list-style-type: none"> ■ 1 pcs ½-14 NPT plug ■ 2 pcs ¾-14 NPT plugs |
| 2 | M20 x 1.5 and M25 x 1.5 adapters, female thread | <ul style="list-style-type: none"> ■ 1 pcs ½-14 NPT plug ■ 2 pcs ¾-14 NPT plugs ■ 4 pcs ½-14 NPT->M20 x 1.5 adapters ■ 2 pcs ¾-14 NPT->M25 x 1.5 adapters |
| G ⁽¹⁾ | Metal cable glands (½-14 and ¾-14 NPT) | <ul style="list-style-type: none"> ■ 1 pcs ½-14 NPT plug ■ 2 pcs ¾-14 NPT plugs ■ 4 pcs ¾-14 NPT cable glands ■ 2 pcs ½-14 NPT cable glands |
| E | eurofast [®] male connector | <ul style="list-style-type: none"> ■ 1 pcs male connector |
| M | minifast [®] male connector | <ul style="list-style-type: none"> ■ 1 pcs ½-14 NPT plug ■ 2 pcs ¾-14 NPT plugs |

(1) Minimum temperature -20 °C (-4 °F). ATEX/IECEX Ex e approved.

Mechanical installation

| Code | Description |
|------|---|
| W | Mounting kit for wall installation |
| P | Mounting kit for both wall and pipe installation (1-2-in. vertical or horizontal pipes) |

Additional options

Safety certificate

Requires Safety certification (SIS) code S.

| Code | Description |
|------|--------------------------------------|
| QT | IEC 61508 certificate and FMEDA data |

Overfill protection approval

Requires Relay output code 1 or 2.

| Code | Description |
|------|---|
| U1 | TÜV/DIBt WHG approval for overfill protection |
| U2 | SVTI approval for overfill protection (Switzerland) |

Tag plate

| Code | Description |
|------|--|
| ST | Engraved SST tag plate (tag shall be submitted with order) |

Extended product warranty

Rosemount extended warranties have a limited warranty of three or five years from date of shipment.

| Code | Description |
|------|-------------------------|
| WR3 | 3-year limited warranty |
| WR5 | 5-year limited warranty |

Emerson Wireless 775 THUM Adapter Assembly



- Add wireless access to any measurement point
- Wireless output protected by industry leading security
- Gain access to additional information such as diagnostics or multivariable data

VIEW PRODUCT >

Required model components

Model

Requires THUM Connection Box.

| Code | Description |
|-------|---|
| 775TG | Wireless 775 THUM Adapter Assembly Tank Gauging |

Output

| Code | Description |
|------|-------------|
| X | Wireless |

Housing

| Code | Description |
|------|-------------|
| D | Aluminum |

Mounting connection

| Code | Description |
|------|---------------------|
| 2 | M20 Conduit adapter |

Input protocol

| Code | Description |
|------|-------------|
| 1 | HART® data |

Certification

| Code | Description |
|------|-----------------------|
| NA | No approval |
| I1 | ATEX Intrinsic Safety |

| Code | Description |
|------|--|
| I2 | Brazil (INMETRO) Intrinsic Safety |
| I3 | China (NEPSI) Intrinsic Safety |
| I4 | Japan (CML) Intrinsically Safe |
| I5 | USA (FM) Intrinsically Safe, Non-incendive |
| I6 | Canada (CSA) Intrinsically Safe |
| I7 | IECEX Intrinsically Safe |
| N1 | ATEX Type n |
| N2 | Brazil (INMETRO) Type n |
| N7 | IECEX Type n |
| IP | Korea (KOSHA) Intrinsic Safety |
| IW | India (CCOE) Intrinsic Safety |
| IM | Technical Regulations Customs Union (EAC) Intrinsic Safety |

Wireless transmit rate, operating frequency, and protocol

| Code | Description |
|------|---|
| WA3 | User-configurable update rate, 2.4 GHz DSSS, IEC 62591 (<i>WirelessHART</i> ®) |

Wireless antenna and SmartPower™ solutions

| Code | Description |
|------|--|
| WK9 | Long range, integral antenna, power scavenging |

Assemble to options

| Code | Description |
|------------------|---------------|
| T ⁽¹⁾ | 2410 Tank Hub |

(1) Factory mounted 220 Ω 4W loop resistor.

Cable/conduit connection

| Code | Description |
|------------------|--------------------------------|
| 0 | None (M20 x 1.5 female thread) |
| J ⁽¹⁾ | Metal cable gland |
| F | ½ NPT adapter (female thread) |

(1) Minimum temperature -20 °C (-4 °F) ATEX/IECEX.

Additional options

Printed tag

| Code | Description |
|-------------------|-------------------------------------|
| PT ⁽¹⁾ | Printed tag for unit identification |

(1) *Maximum 15 characters. Place tag information in order.*

Specifications

General specifications

Material selection

Emerson provides a variety of Rosemount products with various product options and configurations including materials of construction that can be expected to perform well in a wide range of applications. The Rosemount product information presented is intended as a guide for the purchaser to make an appropriate selection for the application. It is the purchaser's sole responsibility to make a careful analysis of all process parameters (such as all chemical components, temperature, pressure, flow rate, abrasives, contaminants, etc.), when specifying product, materials, options, and components for the particular application. Emerson is not in a position to evaluate or guarantee the compatibility of the process fluid or other process parameters with the product, options, configuration or materials of construction selected.

Single tank version

For a Rosemount 5900 system configuration when used in BPCS and safety instrumented systems:

- Supports one Rosemount 5900S 2-in-1 gauge or up to two Rosemount 5900 standard gauges
- Total Observed Volume (TOV) and API corrected Net Standard Volume (NSV) calculation with 100-point strapping table

Multiple tank version

For a Rosemount 5300/5408/5900 system configuration:

- The software supports 16 field devices and 10 tanks per tank hub
- Maximum five type Rosemount 5300 gauges per tank hub

The actual number of tanks/instruments a tank hub supports depends on the configuration, which types of units are connected and how many:

- Hybrid calculations (mass and density) for up to three tanks
- Total Observed Volume (TOV) and API corrected Net Standard Volume (NSV) calculation with 100-point strapping table for one tank

For more information, see [Table 5](#).

Functional safety/SIS applications (SIL 2 single tank) version

The Rosemount 2410:SIS Tank Hub is included in a Rosemount 5900 system configuration when used in safety instrumented systems:

- Supports one Rosemount 5900 SIL 2 safety level device for overfill or dry-run protection
- SIL 2 certified outputs (Relays and Analog Output)
- Data is limited to Tank Position 1: Level, Ullage, Level Rate, Signal Strength, Tank Height, Vapor Temp (Temp 1), and Vapor Pressure
- Typically used in combination with Rosemount 2410 single tank hub for an independent SIL certified protection layer

Supported Rosemount field devices

Level

Rosemount 5900 Radar Level Gauge⁽¹⁾, Rosemount 5408 Level Transmitter, Rosemount 5300 Level Transmitter, and Rosemount 5400 Level Transmitter

Temperature

Rosemount 2240S Multi-input Temperature Transmitter, Rosemount 644 Temperature Transmitter, Rosemount 848T Temperature Transmitter, and Rosemount 3144P Temperature Transmitter

Display

Rosemount 2230 Graphical Field Display and Rosemount 752 FOUNDATION™ Fieldbus Remote Indicator

Pressure

Rosemount 3051 Pressure Transmitter, Rosemount 2051 Pressure Transmitter, Rosemount 3151 Pressure Transmitter, and Rosemount 3051SMV MultiVariable Mass Flow Transmitter

Logic input and output

Rosemount 848L Logic Transmitter with FOUNDATION Fieldbus

Density

Micro Motion™ FDM Fork Density Meter via Micro Motion 2700 Field and Integral-Mount Transmitter

Supported field devices from other vendors**Temperature**

Foxboro® RTT15-F Temperature Transmitter, PR electronics 6350 FOUNDATION™ Fieldbus Transmitter, PR electronics 5350 FOUNDATION Fieldbus Transmitter, Siemens SITRANS TH400, and WIKA T53 Fieldbus Temperature Transmitter

Pressure

Honeywell® SmartLine ST700 Pressure Transmitter, Honeywell SmartLine ST800 Pressure Transmitter, Yokogawa® EJA Series Differential Pressure Transmitter, and Yokogawa EJX430A Gauge Pressure Transmitter

Start-up time

Less than 30 s

(1) One Rosemount 5900S with a 2-in-1 solution or maximum two standard Rosemount 5900 gauges installed on separate tanks can be connected to one tank hub.

Communication/display/configuration specifications

Tankbus

The intrinsically safe side of the Rosemount 2410 connects to the Tankbus, which communicates with the field devices on the tank using FOUNDATION™ Fieldbus.

Fieldbus

Rosemount 2410 communicates with a Rosemount 2460 System Hub, Rosemount TankMaster, or a host via the supported communication protocols for the primary and secondary fieldbus.

| | |
|----------------------------|---|
| Primary fieldbus: | TRL2 Modbus, RS485 Modbus, Analog output/input 4-20 mA/HART, Enraf® Bi-phase Mark GPU, Whessoe WM 550/660 (digital current loop), GPE 31422/31423 (digital current loop), Sakura MDP/V1, or Tokyo Keiso. |
| Secondary fieldbus: | TRL2 Modbus, Analog output/input 4-20 mA/HART, <i>WirelessHART</i> ®, Enraf Bi-phase Mark GPU, L&J Tankway 1500 XL/MCG 2000, Varec® Mark/Space GT 1800/1900, Whessoe WM 550/660 (digital current loop), GPE 31422/31423 (digital current loop), Sakura MDP/V1 or Tokyo Keiso. |

For combination guidance, see [Table 1](#), [Table 2](#), and [Table 3](#).

Relay outputs

| | |
|--|---|
| SIL 3 relay output: | One certified SIL 3 relay is available for overfill prevention. This non-intrinsically safe solid state relay is closed/energized during normal operation. Maximum voltage and current: 260 Vac/Vdc, 80 mA single pole |
| Relay outputs (SIL 2 or non-SIL): | Maximum two relays, controlled by 10 independent virtual relay functions, which can be configured for different tanks and process variables. The two non-intrinsically safe solid state relays are user configurable for normally energized or de-energized operation. Maximum voltage and current: 350 Vac/Vdc, 80 mA single pole |

For combination guidance, see [Table 1](#), [Table 2](#), and [Table 3](#).

Analog input/output

The tank hub supports analog output and input 4-20 mA/HART, active or passive, IS or non-IS. The analog output is available as certified SIL 2.

Analog input

Maximum number of input channels: 1

Input Current range: 0-23 mA

Configurable Min and Max alarm limits.

For IS parameters, see [Product certifications](#).

External Supply Voltage:

- Passive Non-IS: 7.2 - 35 Vdc
- Passive IS: 8.7 – 30 Vdc

Maximum Output Voltage (open loop):

- Active Non-IS: 24 Vdc
- Active IS: 23 Vdc

HART master:

- Maximum 5 HART Slave Devices (Passive)
- Maximum 3 HART Slave Devices (Active)

Figure 5: Loop Resistance: Passive Non-IS Analog Input

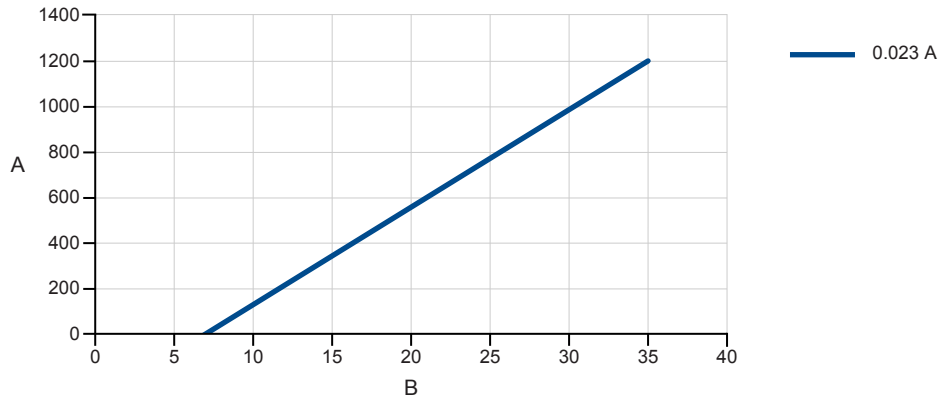

- A. Loop resistance [Ω]
- B. External power supply voltage [V]

Max Loop Resistance⁽²⁾ @ 23 mA = 43.4 * (External Power Supply Voltage - 7.2) [Ω]

Figure 6: Loop Resistance: Passive IS Analog Input

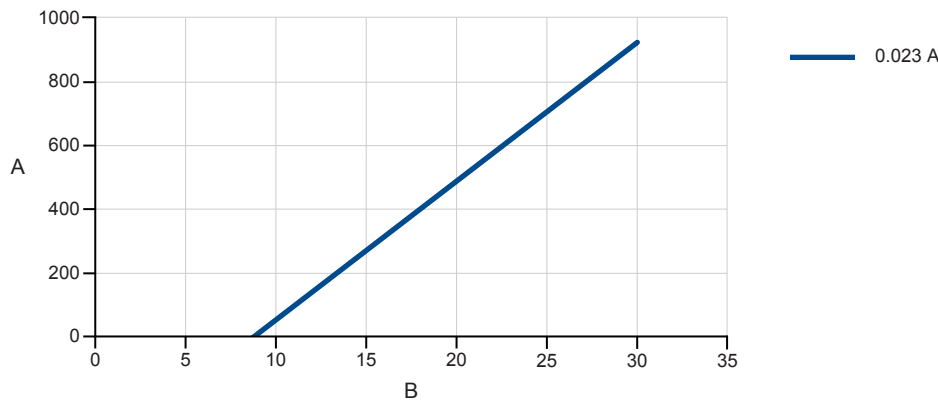

- A. Loop resistance [Ω]
- B. External power supply voltage [V]

Max Loop Resistance⁽²⁾ @ 23 mA = 43.4 * (External Power Supply Voltage - 8.7) [Ω]

(2) Any sense resistance must be subtracted from calculated max loop resistance to receive the maximum cable resistance.

Figure 7: Loop Resistance: Active Non-IS Analog Input

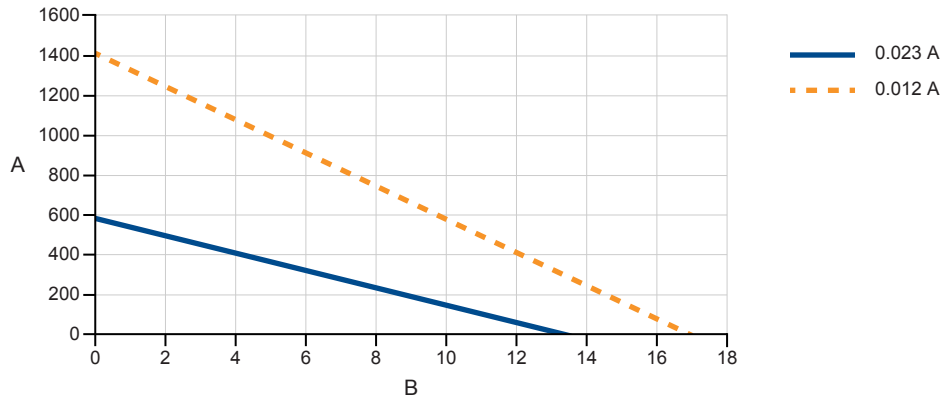

- A. Loop resistance [Ω]
- B. Lift-off voltage [V]

Max Loop Resistance⁽²⁾ = (20.9 – Lift-off Voltage)/Max Loop Current – 330 [Ω]

Figure 8: Loop Resistance: Active IS Analog Input

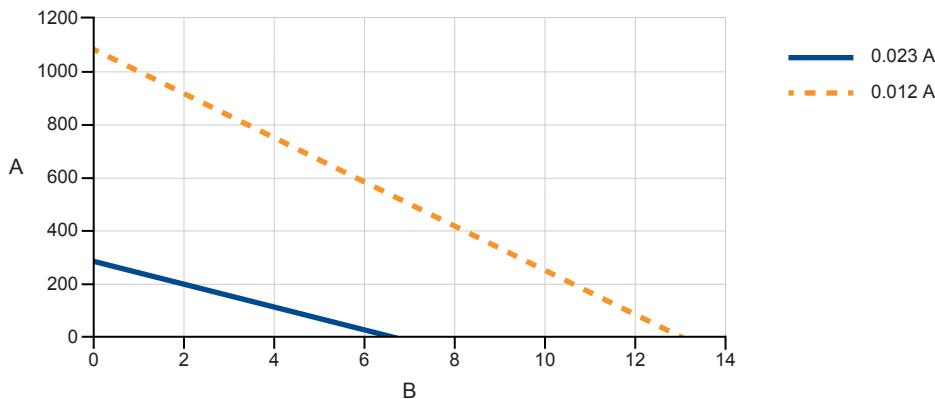

- A. Loop resistance [Ω]
- B. Lift-off voltage [V]

Max Loop Resistance⁽²⁾ = (20.1 – Lift-off Voltage)/Max Loop Current – 590 [Ω]

Analog output

Maximum number of output channels: 1

Output range: 3.5-23 mA

Software configurable High and Low Alarm Limits.

Separate software configurable alarms for process and hardware failures.

Low voltage and invalid loop current detection.

SIL 2 capable.

External Supply Voltage:

- Passive Non-IS: 8.0 - 35 Vdc
- Passive IS: 9.4 – 30 Vdc

Maximum Output Voltage (open loop):

- Active Non-IS: 24 Vdc
- Active IS: 23 Vdc

Figure 9: Loop Resistance: Passive Non-IS Analog Output

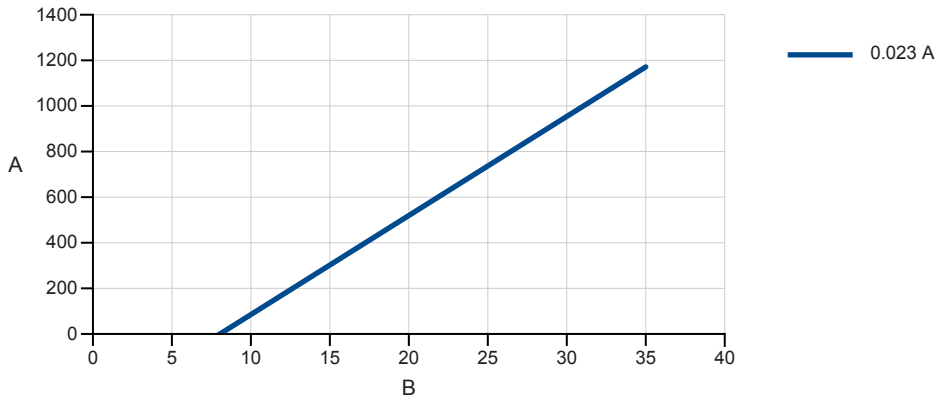

- A. Loop resistance [Ω]
- B. External power supply voltage [V]

Max Loop Resistance⁽²⁾ @ 23 mA = 43.4 * (External Power Supply Voltage – 8) [Ω]

Figure 10: Loop Resistance: Passive IS Analog Output

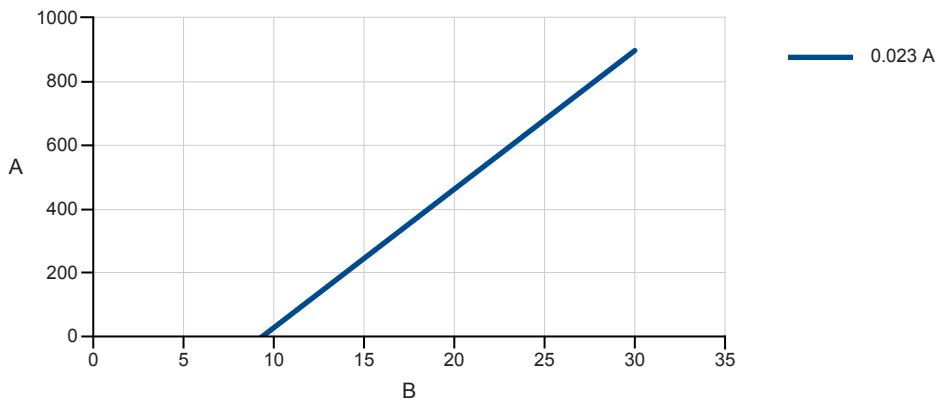

- A. Loop resistance [Ω]
- B. External power supply voltage [V]

Max Loop Resistance⁽²⁾ @ 23 mA = 43.4 * (External Power Supply Voltage – 9.4) [Ω]

Figure 11: Loop Resistance: Active Non-IS Analog Output

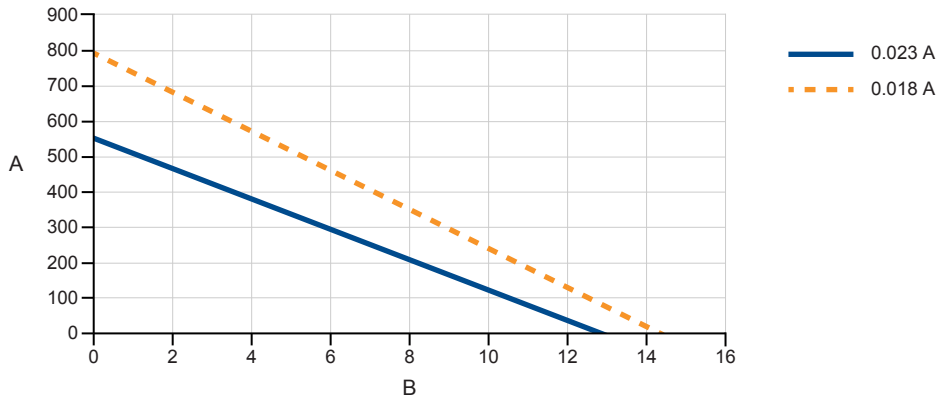

- A. Loop resistance [Ω]
- B. Lift-off voltage [V]

Max Loop Resistance⁽²⁾ = (20.3 – Lift-off Voltage)/Max Loop Current – 330 [Ω]

Figure 12: Loop Resistance: Active IS Analog Output

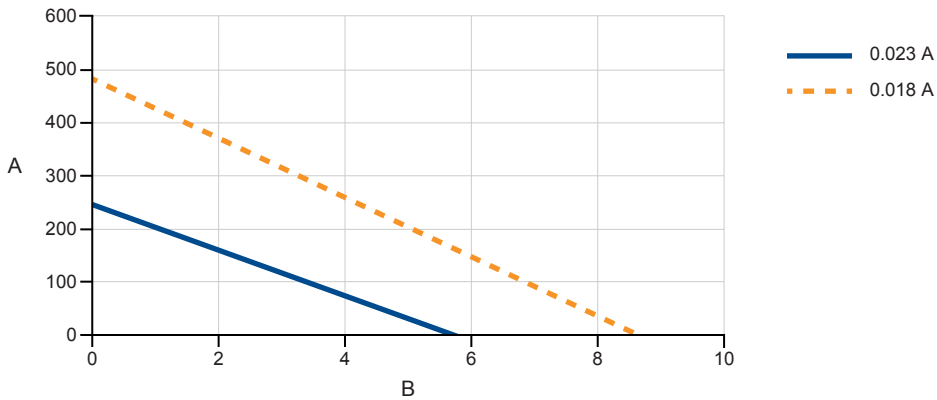

- A. Loop resistance [Ω]
- B. Lift-off voltage [V]

Max Loop Resistance⁽²⁾ = (19.5 – Lift-off Voltage)/Max Loop Current – 600 [Ω]

Fieldbus combinations

Table 1: Fieldbus Combination Matrix (Non-SIL)

| | | Primary Fieldbus options | | | | | |
|---|------|--------------------------|-------|-------|---|-----------------------------------|----------------------------------|
| | | TRL2 | RS485 | Enraf | Whessoe, GPE, Sakura, Tokyo Keiso | Analog out passive (non-IS) | Analog In passive (non-IS) |
| Secondary Fieldbus options | Code | R | 4 | E | H, G, U, T | B | 7 |
| TRL2 | R | Yes | Yes | No | No | No | No |
| Enraf | E | Yes | Yes | No | No | No | No |
| WirelessHART® | W | Yes | Yes | Yes | Yes | Yes | Yes |
| L&J Tankway 1500 XL/MCG 2000 | L | Yes | Yes | No | No | No | No |
| Varec Mark/Space GT 1800/1900 | V | Yes | Yes | No | No | No | No |
| Whessoe WM 550/660 (digital current loop) | H | Yes | Yes | No | No | No | No |
| GPE 31422/31423 (digital current loop) | G | Yes | Yes | No | No | No | No |
| Sakura MDP/V1 | U | Yes | Yes | No | No | No | No |
| Tokyo Keiso | T | Yes | Yes | No | No | No | No |
| Analog out active (IS) | C | Yes | Yes | Yes | No | No | No |
| Analog out active (non-IS) | A | Yes | Yes | Yes | No | No | No |
| Analog out passive (IS) | D | Yes | Yes | Yes | No | No | No |
| Analog out passive (non-IS) | B | Yes | Yes | Yes | No | No | No |
| Analog in active (IS) | 8 | Yes | Yes | Yes | No | No | No |
| Analog in active (non-IS) | 6 | Yes | Yes | Yes | No | No | No |
| Analog in passive (IS) | 9 | Yes | Yes | Yes | No | No | No |
| Analog in passive (non-IS) | 7 | Yes | Yes | Yes | No | No | No |
| None | 0 | Yes | Yes | Yes | No | No | No |
| Ready for upgrade | F | Yes | Yes | Yes | No | No | No |

Yes = Primary Fieldbus and Secondary Fieldbus can be combined

No = Combination not possible

Table 2: Fieldbus Combination Matrix (SIL)

| | | Primary Fieldbus options | | | | | |
|--|------|-----------------------------------|-----------------------------------|-----------------------------------|---|------------------------------------|----------------------------------|
| | | TRL2 | RS485 | Enraf | Whessoe, GPE, Sakura, Tokyo Keiso | Analog out passive (non-IS) | Analog In passive (non-IS) |
| Secondary Fieldbus options | Code | R | 4 | E | H, G, U, T | B | 7 |
| TRL2 | R | SIL 2 (relay) | SIL 2 (relay) | No | No | No | No |
| Enraf | E | SIL 2 (relay) | SIL 2 (relay) | No | No | No | No |
| WirelessHART | W | SIL 2 (relay) | SIL 2 (relay) or SIL 3 (relay) | SIL 2 (relay) | SIL 2 (relay) | SIL 2 (4-20 mA and/or relay) | SIL 2 (relay) |
| L&J Tankway 1500 XL/MCG 2000 | L | SIL 2 (relay) | SIL 2 (relay) | No | No | No | No |
| Varec Mark/Space GT 1800/1900 | V | SIL 2 (relay) | SIL 2 (relay) | No | No | No | No |
| Whessoe WM 550/660 (digital current loop) | H | SIL 2 (relay) | SIL 2 (relay) | No | No | No | No |
| GPE 31422/31423 (digital current loop) | G | SIL 2 (relay) | SIL 2 (relay) | No | No | No | No |
| Sakura MDP/V1 | U | SIL 2 (relay) | SIL 2 (relay) | No | No | No | No |
| Tokyo Keiso | T | SIL 2 (relay) | SIL 2 (relay) | No | No | No | No |
| Analog out active (IS) | C | SIL 2 (4-20 mA and/or relay) | SIL 2 (relay) or SIL 3 (relay) | SIL 2 (4-20 mA and/or relay) | No | No | No |
| Analog out active (non- IS) | A | SIL 2 (4-20 mA and/or relay) | SIL 2 (4-20 mA and/or relay) | SIL 2 (4-20 mA and/or relay) | No | No | No |
| Analog out passive (IS) | D | SIL 2 (4-20 mA and/or relay) | SIL 2 (relay) or SIL 3 (relay) | SIL 2 (4-20 mA and/or relay) | No | No | No |
| Analog out passive (non- IS) | B | SIL 2 (4-20 mA and/or relay) | SIL 2 (4-20 mA and/or relay) | SIL 2 (4-20 mA and/or relay) | No | No | No |
| Analog in active (IS) | 8 | SIL 2 (relay) | SIL 2 (relay) or SIL 3 (relay) | SIL 2 (relay) | No | No | No |
| Analog in active (non-IS) | 6 | SIL 2 (relay) | SIL 2 (relay) | SIL 2 (relay) | No | No | No |
| Analog in passive (IS) | 9 | SIL 2 (relay) | SIL 2 (relay) or SIL 3 (relay) | SIL 2 (relay) | No | No | No |
| Analog in passive (non- IS) | 7 | SIL 2 (relay) | SIL 2 (relay) | SIL 2 (relay) | No | No | No |
| None | 0 | SIL 2 (relay) or SIL 3 (relay) | SIL 2 (relay) or SIL 3 (relay) | SIL 2 (relay) or SIL 3 (relay) | No | No | No |
| Ready for upgrade | F | SIL 2 (4-20 mA and/or relay) | SIL 2 (4-20 mA and/or relay) | SIL 2 (4-20 mA and/or relay) | No | No | No |

SIL = Primary Fieldbus and Secondary Fieldbus can be combined with SIL

No = Combination not possible

Table 3: Fieldbus Combination Matrix (Rosemount 2410:SIS)

| | | Primary Fieldbus options | | |
|-----------------------------|------|------------------------------|--------------------------------|------------------------------|
| | | TRL2 | RS485 | Analog out passive (non-IS) |
| Secondary Fieldbus options | Code | R | 4 | B |
| TRL2 | R | SIL 2 (relay) | SIL 2 (relay) | No |
| WirelessHART | W | SIL 2 (relay) | SIL 2 (relay) | SIL 2 (4-20 mA and/or relay) |
| Analog out active (IS) | C | SIL 2 (4-20 mA and/or relay) | SIL 2 (4-20 mA and/or relay) | No |
| Analog out active (non-IS) | A | SIL 2 (4-20 mA and/or relay) | SIL 2 (4-20 mA and/or relay) | No |
| Analog out passive (IS) | D | SIL 2 (4-20 mA and/or relay) | SIL 2 (relay) or SIL 3 (relay) | No |
| Analog out passive (non-IS) | B | SIL 2 (4-20 mA and/or relay) | SIL 2 (4-20 mA and/or relay) | No |
| None | 0 | SIL 2 (relay) | SIL 2 (relay) | No |
| Ready for upgrade | F | SIL 2 (4-20 mA and/or relay) | SIL 2 (4-20 mA and/or relay) | No |

SIL = Primary Fieldbus and Secondary Fieldbus can be combined with SIL

No = Combination not possible

Integral display output variables

The integral digital read-out display can toggle between:

- Level
- Level rate
- Ullage
- Signal strength
- Volume (TOV)
- Liquid average temperature
- 1-16 spot temperature
- Vapor average temperature
- Ambient temperature
- Free water level
- Vapor pressure
- Liquid pressure
- Air pressure
- Observed density
- Reference density
- Flow rate

Display output units

| | |
|---|--|
| Level, free water level, and ullage: | meter, millimeter, feet, or imperial 1/16 |
| Level rate: | meter/second, meter/hour, feet/second, or feet/hour |
| Flow rate: | meter ³ /hour, liter/minute, barrel/hour, or US gallon/hour |
| Total Observed Volume (TOV): | meter ³ , liters, barrel, or US gallon |
| Temperature: | °F, °C, or °K |
| Pressure: | psi, psiA, psiG, bar, barA or barG, atm, Pa, or kPa |
| Density: | kg/m ³ , °API, or 60/60DegF |
| Signal strength: | mV |

Density, mass, and more volume parameters are calculated in Rosemount TankMaster (GOV, GSV, NSV, WIA/WIV).

Configuration tools

Rosemount TankMaster

Autoconfiguration support

Yes (Tankbus addressing)

Electrical specifications

Power supply (nominal values)

24-48 Vdc (-15% to +10%) 48-240 Vac (-15% to +10%), 50/60 Hz

Power consumption

Max. 20 W depending on configuration.

Recommended Miniature Circuit Breaker (MCB): 2A slow

Tankbus cabling

0.5-1.5 mm² (AWG 22-16), twisted shielded pairs. Recommended cabling is shielded twisted pairs, 0.75 mm² (AWG 18). Tankbus cabling must fulfill FISCO cable and installation requirements, and must also be approved for use at minimum 85 °C (185 °F).

FISCO (Fieldbus Intrinsically Safe Concept)

The following cable characteristics are specified for FISCO:

Table 4: FISCO Cable Parameters

| Parameter ⁽¹⁾ | Value |
|---|---|
| Loop resistance | 15 Ω/km to 150 Ω/km |
| Loop inductance | 0.4 mH/km to 1 mH/km |
| Capacitance | 45 nF/km to 200 nF/km |
| Maximum length of each spur ⁽²⁾ cable | 60 m in apparatus class IIC and IIB |
| Maximum cable length including trunk ⁽³⁾ and spurs | 1000 m in apparatus class IIC and 1900 m in apparatus class IIB |

(1) For further information see requirements of the IEC 61158-2 standard.

(2) A spur is an unterminated part of the network.

(3) A trunk is the longest cable path between two devices on the fieldbus network, and is the part of the network which has terminations at both ends. In the Rosemount Tank Gauging system, a trunk is typically located between the Rosemount 2410 Tank Hub and a segment coupler or the last device in a daisy-chain configuration.

Power budget

Table 5: Power Consumption for Various Rosemount Tank Gauging Devices

| Field device | Power consumption |
|---|--|
| Rosemount 5900S Radar Level Gauge | 50 mA |
| Rosemount 5900C Radar Level Gauge | 50 mA |
| Rosemount 5900S Radar Level Gauge, 2-in-1 solution | 100 mA |
| Rosemount 5300 Level Transmitter | 21 mA |
| Rosemount 5408 Level Transmitter | 21 mA |
| Rosemount 2230 Graphical Field Display | 30 mA |
| Rosemount 2240S Multi-input Temperature Transmitter | 30 mA including 565, 566 and 765 temperature sensors |
| Rosemount 644 Temperature Transmitter | 12 mA |
| Rosemount 3051S, and Rosemount 2051 Pressure Transmitters | 18 mA |

Allowed cabling distances

Figure 13: Cable Distances

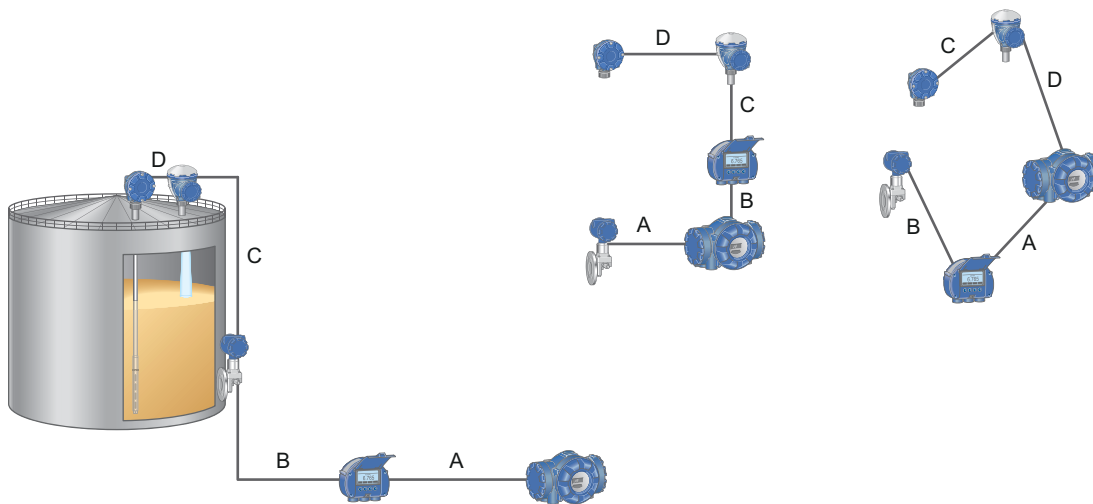

The total cable distance A+B+C+D must not exceed the values given in [Table 6](#).

Table 6: Allowed Cabling Distances for Different System Configurations

| Cable diameter | Loop resistance | Maximum cabling distance from power source to all devices on the tank | | |
|--------------------------------|-----------------|---|--|---|
| | | With maximum power usage of 250 mA Distance in m (ft) | With typical power usage of 128 mA for 5900S, 2240S, 2230, 3051S Distance in m (ft) | With typical power usage of 178 mA for 5900S 2-in-1, 2240S, 2230, 3051S Distance in m (ft) |
| 20 AWG (0.5 mm ²) | 66 Ω/km | 212 (695) | 414 (1358) | 298 (978) |
| 18 AWG (0.75 mm ²) | 42 Ω/km | 333 (1092) | 651 (2136) | 468 (1535) |
| 17 AWG (1.0 mm ²) | 33 Ω/km | 424 (1391) | 829 (2720) | 596 (1955) |
| 16 AWG (1.5 mm ²) | 26 Ω/km | 538 (1765) | 1000 (3281) | 756 (2480) |

The typical cabling distance from the tank hub toward the control room is up to 4 km (2.5 miles) depending on which protocol is used.

Power and relay cabling

0.5-2.5 mm² (AWG 22-14), twisted shielded pairs

Maximum Tankbus cable lengths

Depends on the cable. For details, see the Rosemount Tank Gauging [System Data Sheet](#).

Built-in Tankbus terminator

The Rosemount 2410 Tank Hub has a built-in tank bus terminator, which can be disconnected if required.

Mechanical specifications

Housing material

Polyurethane-covered die-cast aluminum

Cable entry (connection/glands)

Non-IS side: Two ½ - 14 NPT and Two ¾ - 14 NPT entries for cable glands or conduits

IS side: Two ½ - 14 NPT entries for cable glands or conduits

Three metal plugs to seal any unused ports are included in the delivery

Optional:

- M20 x 1.5 and M25 x 1.5 conduit/cable adapter
- Cable glands in metal (½ - 14 NPT and ¾ - 14 NPT)
- 4-pin male eurofast connector or A size Mini 4-pin male minifast connector

Installation

Can be installed on a 33.4-60.3 mm (1-2 in.) diameter pipe or wall, at ground level close to the tank or on top of the tank using existing cabling.

Weight

4.7 kg (10.4 lbs)

Environmental specifications

Temperature limits

Ambient temperature

-40 to 70 °C (-40 to 158 °F). Minimum start-up temperature is -50 °C (-58 °F).

With LCD display: -25 to 70 °C (-13 to 158 °F)

Storage temperature

-50 to 85 °C (-58 to 185 °F)

With LCD display: -40 to 85 °C (-40 to 185 °F)

Humidity

0 - 100% relative humidity

Ingress protection

IP 66 and IP 67 (NEMA® 4X)

Metrology sealing possibility

Yes

Write-protect switch

Yes (hardware and software write-protection)

Transient/built-in lightning protection

In accordance with IEC 61000-4-5, level 4 kV line to ground. Compliant with IEEE 587 category B transient protection and IEEE 472 surge protection.

Specifications for Emerson Wireless 775 THUM Adapter Assembly

Note

For more information, see the Emerson Wireless 775 THUM Adapter [Product Data Sheet](#).

General specifications

The THUM Adapter allows *WirelessHART*[®] communication according to the IEC 62591 standard between the Rosemount 2410 Tank Hub and the Emerson Wireless Gateway. The THUM is integrated with a connection box.

Transmission range

Application dependent. Consult factory

Communication specifications

Communication protocol

IEC 62591 (*WirelessHART*[®])

Radio characteristics

- Standard IEEE 802.15.4 radio
- 2.4 GHz ISM band sliced into 16 radio-channels
- Continually “hop” across channels to avoid interference and increase reliability
- Direct sequence spread spectrum (DSSS) delivers high reliability in challenging radio environment

Update rate

User selectable, eight seconds to 60 minutes

Electrical specifications

Power supply

Powered by Rosemount 2410 Tank Hub

Output cabling

Shielded twisted pair wiring, 0.5-2.5 mm² (AWG 22-14)

Maximum cable length depends on cable characteristics.

Mechanical specifications

Materials of construction

Housing/enclosure

Polyurethane painted, low-copper aluminum housing

Antenna

Polybutadine terephthalate (PBT)/polycarbonate (PC) integrated omnidirectional antenna

Cable entry (connection/glands)

One M20 x 1.5 entry for cable gland or conduit adapter

Optional:

- Metal cable gland M20 x 1.5
- ½ NPT adapter (female thread)

Installation

The THUM Adapter can be installed on a vertical or horizontal 1- to 2-in. pipe, away from the tank hub at the best possible tank roof position. It should be installed approximately 2 m (6 ft) or more from any large structure or conductive surface.

Weight

Connection box and THUM Adapter: 2.0 kg (4.4 lbs.)

Environmental specifications

Temperature limits

Ambient temperature

-40 to 85 °C (-40 to 185 °F)

Storage temperature

-40 to 85 °C (-40 to 185 °F)

Humidity limits

0 - 100% relative humidity

Ingress protection

IP 66 and NEMA 4X

Product certifications

Rev 3.8

For more information on product certificates, refer to the Rosemount 2410 [Reference Manual](#).

European directive information

The most recent revision of the EU Declaration of Conformity can be found at [Emerson.com/Rosemount](https://emerson.com/rosemount).

Ordinary location certification

As standard, the transmitter has been examined and tested to determine that the design meets the basic electrical, mechanical, and fire protection requirements by a nationally recognized test laboratory (NRTL) as accredited by the Federal Occupational Safety and Health Administration (OSHA).

Installing equipment in North America

The US National Electrical Code® (NEC) and the Canadian Electrical Code (CEC) permit the use of Division marked equipment in Zones and Zone marked equipment in Divisions. The markings must be suitable for the area classification, gas, and temperature class. This information is clearly defined in the respective codes.

North America

E5 USA Explosion-proof

| | |
|-------------------------------------|--|
| Certificate | FM16US0123X |
| Standards | FM Class 3600:2018, FM Class 3610:2018, FM Class 3615:2018, FM Class 3810:2005, NEMA 250-2003, ANSI/IEC 60529:2004, ANSI/UL 60079-0:2019, ANSI/UL 60079-7:2017, ANSI/UL 60079-11:2014, ANSI/UL 61010-1:2004 |
| Markings FISCO | For b = Tank Bus (Fieldbus - Power and Communication): F and when d = Secondary Communication Bus (Non-IS): R, E, 5, K, L, V, H, G, A, U, T, B, 6, 7, 0, or F: FISCO POWER SUPPLY XP CL 1, DIV 1 GPS C, D & Associated Apparatus providing IS circuit to CL I, DIV 1, GPS C & D; DIP CL II/III, DIV. 1, GP E, F & G; CL I, ZONE 1 AEx db eb [ib] IIB Gb Amb. Temp. Limits -50 °C to +70 °C Temp. Class T4 SEE CONTROL DRAWING D9240040-901 ENCL. TYPE 4X, IP66, IP67. |
| Markings FISCO HART active | When b = Tank Bus (Fieldbus - Power and Communication): F and when d = Secondary Communication Bus (HART®/4-20mA Active IS Input/Output): W, C or 8: FISCO POWER SUPPLY XP CL 1, DIV 1 GPS C, D & Associated Apparatus providing IS circuit to CL I, DIV 1, GPS C & D; DIP CL II/III, DIV. 1, GP E, F & G; CL I, ZONE 1 AEx db eb [ib] IIB Gb ENTITY IS I/O ACTIVE: XP CL 1, DIV 1 GPS C, D & Associated Apparatus providing IS circuit to CL 1, DIV 1, GPS C & D ACTIVE: CL I, ZONE 0 AEx db eb [ia IIC Ga] IIB Gb Amb. Temp. Limits -50 °C to +70 °C Temp. Class T4 SEE CONTROL DRAWING D9240040-901 Type 4X; IP66/67. |
| Markings FISCO HART passive | When b = Tank Bus (Fieldbus - Power and Communication): F and when d = Secondary Communication Bus (HART®/4-20mA Passive IS Input/Output): D or 9. FISCO POWER SUPPLY XP CL 1, DIV 1 GPS C, D & Associated Apparatus providing IS circuit to CL I, DIV 1, GPS C & D; DIP CL II/III, DIV. 1, GP E, F & G; CL I, ZONE 1 AEx db eb [ib] IIB Gb ENTITY IS I/O PASSIVE: CL I, ZONE 1 AEx db eb [ib] IIB Gb Amb. Temp. Limits -50 °C to +70 °C Temp. Class T4 SEE CONTROL DRAWING D9240040-901 Type 4X; IP66/67. |
| Markings Entity | When b = Tank Bus (Fieldbus - Power and Communication): E and when d = Secondary Communication Bus (Non-IS): R, E, 5, K, L, V, H, G, A, U, T, B, 6, 7, 0, or F: ENTITY IS POWER SUPPLY XP CL I, DIV 1 GPS C, D & Associated Apparatus providing IS circuit to CL I, DIV 1, GPS C & D; DIP CL II/III, DIV. 1, GP E, F & G; CL I, ZONE 1 AEx db eb [ib] IIB Gb ENTITY Uo: 15.0 V, Io: 200 mA, Po: 3.0 W Co: 1.9 µF, Lo: 143 µH Amb. Temp. Limits -50 °C to +70 °C Temp. Class T4 SEE CONTROL DRAWING D7000002-611 Type 4X; IP66/67. |
| Markings Entity HART active | When b = Tank Bus (Fieldbus - Power and Communication): E and when d = Secondary Communication Bus (HART®/4-20mA Active IS Input/Output): W, C or 8. ENTITY IS POWER SUPPLY XP CL I, DIV 1 GPS C, D & Associated Apparatus providing IS circuit to CL I, DIV 1, GPS C & D; DIP CL II/III, DIV. 1, GP E, F & G; CL I, ZONE 1 AEx db eb [ib] IIB Gb ENTITY IS I/O ACTIVE: XP CL I, DIV 1 GPS C, D & Associated Apparatus providing IS circuit to CL I, DIV 1, GPS C & D ACTIVE: CL I, ZONE 0 AEx db eb [ia IIC Ga] IIB Gb Amb. Temp. Limits -50 °C to +70 °C Temp. Class T4 SEE CONTROL DRAWING D7000002-611 Type 4X; IP66/67. |
| Markings Entity HART passive | When b = Tank Bus (Fieldbus - Power and Communication): E and when d = Secondary Communication Bus (HART®/4-20mA Passive IS Input/Output): D or 9: ENTITY IS POWER SUPPLY XP CL I, DIV 1 GPS C, D & Associated Apparatus providing IS circuit to CL I, DIV 1, GPS C & D; DIP CL II/III, DIV. 1, GP E, F & G; CL I, ZONE 1 AEx db eb [ib] IIB Gb ENTITY IS I/O PASSIVE: CL I, ZONE 1 AEx db eb [ib] IIB Gb Amb. Temp. Limits -50 °C to +70 °C Temp. Class T4 SEE CONTROL DRAWING D7000002-611 Type 4X; IP66/67. |

Specific Conditions of Use (X):

1. The flamepaths of the equipment are not intended to be repaired. Consult the manufacturer if repair of the flamepath joints is necessary.

| Ex marking | Comm. Bus | Uo V | Io mA | Po W | Co μF | Lo mH | Group |
|--------------------------------|--------------------|---------|----------|---------|----------|----------|-------|
| Ex db eb [ib] IIB T4 Gb | FISCO | 15 | 354 | 5.32 | - | - | IIB |
| Ex db eb [ia IIC Ga] IIB T4 Gb | HART/4-20mA Active | 23.1 | 95.3 | 0.55 | 0.14 | 3.9 | IIC |
| | | | | | 1.0 | 15 | IIB |
| | | | | | 3.67 | 33 | IIA |
| Ex db eb [ib] IIB T4 Gb | Fieldbus | 15 | 200 | 3 | 1.99 | 143 μH | IIB |

| Ex marking | Comm. Bus | Ui V | Ii mA | Pi W | Ci μF | Li mH | Group |
|-----------------------|---------------------|---------|----------|---------|----------|----------|-------|
| Ex db eb ib IIB T4 Gb | HART/4-20mA Passive | 30 | 300 | 1 | 0 | 0 | IIB |

E6 Canada Explosion-proof

| | |
|-------------------------------------|---|
| Certificate | FM16CA0068X |
| Standards | CSA C22.2 No 0.4:2017 CSA C22.2 No. 0.5:2016 CSA C22.2 No. 30:2020 CSA C22.2 No. 94-M91:1991 (Reaffirmed 2011) CSA C22.2 No. 1010.1:2004 (Reaffirmed 2009) CAN/CSA 60079-0:2019 CAN/CSA 60079-1:2016 CSA C22.2 60079-7:2016 CAN/CSA 60079-11:2014 CSA C22.2 No. 60529:2016 |
| Markings FISCO | For b = Tank Bus (Fieldbus - Power and Communication): F and when d = Secondary Communication Bus (Non-IS): R, E, 5, K, L, V, H, G, A, U, T, B, 6, 7, 0, or F: FISCO POWER SUPPLY XP CL 1, DIV 1 GPS C, D & Associated Apparatus providing IS circuit to CL I, DIV 1, GPS C & D; DIP CL II/III, DIV. 1, GP E, F & G; CL I, ZONE 1 Ex db eb [ib] IIB Gb Amb. Temp. Limits -50 °C to +70 °C Temp. Class T4 SEE CONTROL DRAWING D9240040-901 Type 4X; IP66/67 |
| Markings FISCO HART active | When b = Tank Bus (Fieldbus - Power and Communication): F and when d = Secondary Communication Bus (HART®/4-20mA Active IS Input/Output): W, C or 8: FISCO POWER SUPPLY XP CL 1, DIV 1 GPS C, D & Associated Apparatus providing IS circuit to CL I, DIV 1, GPS C & D; DIP CL II/III, DIV. 1, GP E, F & G; CL I, ZONE 1 Ex db eb [ib] IIB Gb ENTITY IS I/O ACTIVE: XP CL 1, DIV 1 GPS C, D & Associated Apparatus providing IS circuit to CL 1, DIV 1, GPS C & D ACTIVE: CL I, ZONE 0 Ex db eb [ia IIC Ga] IIB Gb Amb. Temp. Limits -50 °C to +70 °C Temp. When b = Tank Bus (Fieldbus - Power and Communication): F and when d = Secondary Communication Bus (HART®/4-20mA Passive IS Input/Output): D or 9. Class T4 SEE CONTROL DRAWING D9240040-901 Type 4X; IP66/67 |
| Markings FISCO HART passive | When b = Tank Bus (Fieldbus - Power and Communication): F and when d = Secondary Communication Bus (HART®/4-20mA Passive IS Input/Output): D or 9: FISCO POWER SUPPLY XP CL 1, DIV 1 GPS C, D & Associated Apparatus providing IS circuit to CL I, DIV 1, GPS C & D; DIP CL II/III, DIV. 1, GP E, F & G; CL I, ZONE 1 Ex db eb [ib] IIB Gb ENTITY IS I/O PASSIVE: CL I, ZONE 1 Ex db eb ib IIB Gb Amb. Temp. Limits -50 °C to +70 °C Temp. Class T4 SEE CONTROL DRAWING D9240040-901 Type 4X; IP66/67 |
| Markings Entity | When b = Tank Bus (Fieldbus - Power and Communication): E and when d = Secondary Communication Bus (Non-IS): R, E, 5, K, L, V, H, G, A, U, T, B, 6, 7, 0, or F: ENTITY IS POWER SUPPLY XP CL I, DIV 1 GPS C, D & Associated Apparatus providing IS circuit to CL I, DIV 1, GPS C & D; DIP CL II/III, DIV. 1, GP E, F & G; CL I, ZONE 1 Ex db eb [ib] IIB Gb Amb. Temp. Limits -50 °C to +70 °C Temp. Class T4 SEE CONTROL DRAWING D7000002-611 Type 4X; IP66/67 |
| Markings Entity HART active | When b = Tank Bus (Fieldbus - Power and Communication): E and when d = Secondary Communication Bus (HART®/4-20mA Active IS Input/Output): W, C or 8: ENTITY IS POWER SUPPLY XP CL I, DIV 1 GPS C, D & Associated Apparatus providing IS circuit to CL I, DIV 1, GPS C & D; DIP CL II/III, DIV. 1, GP E, F & G; CL I, ZONE 1 Ex db eb [ib] IIB Gb ENTITY IS I/O ACTIVE: XP CL I, DIV 1 GPS C, D & Associated Apparatus providing IS circuit to CL I, DIV 1, GPS C & D ACTIVE: CL I, ZONE 0 Ex db eb [ia IIC Ga] IIB Gb Amb. Temp. Limits -50 °C to +70 °C Temp. Class T4 SEE CONTROL DRAWING D7000002-611 Type 4X; IP66/67 |
| Markings Entity HART passive | When b = Tank Bus (Fieldbus - Power and Communication): E and when d = Secondary Communication Bus (HART®/4-20mA Passive IS Input/Output): D or 9: ENTITY IS POWER SUPPLY XP CL I, DIV 1 GPS C, D & Associated Apparatus providing IS circuit to CL I, DIV 1, GPS C & D; DIP CL II/III, DIV. 1, GP E, F & G; CL I, ZONE 1 Ex db eb [ib] IIB Gb ENTITY IS I/O PASSIVE: CL I, ZONE 1 Ex db eb ib IIB Gb Amb. Temp. Limits -50 °C to +70 °C Temp. Class T4 SEE CONTROL DRAWING D7000002-611 Type 4X; IP66/67 |

Specific Conditions of Use (X):

1. The flamepaths of the equipment are not intended to be repaired. Consult the manufacturer if repair of the flamepath joints is necessary.

| Ex marking | Comm. Bus | Uo V | Io mA | Po W | Co μF | Lo mH | Group |
|--------------------------------|--------------------|---------|----------|---------|----------|----------|-------|
| Ex db eb [ib] IIB T4 Gb | FISCO | 15 | 354 | 5.32 | - | - | IIB |
| Ex db eb [ia IIC Ga] IIB T4 Gb | HART/4-20mA Active | 23.1 | 95.3 | 0.55 | 0.14 | 3.9 | IIC |
| | | | | | 1.0 | 15 | IIB |
| | | | | | 3.67 | 33 | IIA |
| Ex db eb [ib] IIB T4 Gb | Fieldbus | 15 | 200 | 3 | 1.99 | 143 μH | IIB |

| Ex marking | Comm. Bus | Ui V | Ii mA | Pi W | Ci μF | Li mH | Group |
|-----------------------|---------------------|---------|----------|---------|----------|----------|-------|
| Ex db eb ib IIB T4 Gb | HART/4-20mA Passive | 30 | 300 | 1 | 0 | 0 | IIB |

Europe

E1 ATEX Flame-proof

Certificate FM10ATEX0012X

Standards EN IEC 60079-0:2018, EN 60079 - 1:2014, EN IEC 60079 - 7:2015 + A1:2018, EN 60079 - 11:2012, EN 60529:1992 + A1:2013 + A2:2013

Markings:  TANK HUB
 II 2(2) G Ex db eb [ib] IIB T4 Gb Ta = -50 °C to 70 °C; IP66, IP67
 TANK HUB (with Active Modem HART Board)
 II 2(2) G Ex db eb [ib] IIB T4 Gb Ta = -50 °C to +70 °C, IP66 / IP6
 II 2(1) G Ex db eb [ia IIC Ga] IIB T4 Gb Ta = -50 °C to 70 °C; IP66, IP67
 TANK HUB (with Passive Modem HART Board)
 II 2(2) G Ex db eb [ib] IIB T4 Gb Ta = -50 °C to +70 °C, IP66 / IP67
 II 2 G Ex db eb ib IIB T4 Gb Ta = -50 °C to 70 °C; IP66, IP67

Specific Conditions of Use (X):

1. The flamepaths of the equipment are not intended to be repaired. Consult the manufacturer if repair of the flamepath joints is necessary.

| Ex marking | Comm. Bus | Uo V | Io mA | Po W | Co µF | Lo mH | Group |
|--------------------------------|--------------------|---------|----------|---------|----------|----------|-------|
| Ex db eb [ib] IIB T4 Gb | FISCO | 15 | 354 | 5.32 | - | - | IIB |
| Ex db eb [ia IIC Ga] IIB T4 Gb | HART/4-20mA Active | 23.1 | 95.3 | 0.55 | 0.14 | 3.9 | IIC |
| | | | | | 1.0 | 15 | IIB |
| | | | | | 3.67 | 33 | IIA |
| Ex db eb [ib] IIB T4 Gb | Fieldbus | 15 | 200 | 3 | 1.99 | 143 µH | IIB |

| Ex marking | Comm. Bus | Ui V | Ii mA | Pi W | Ci µF | Li mH | Group |
|-----------------------|---------------------|---------|----------|---------|----------|----------|-------|
| Ex db eb ib IIB T4 Gb | HART/4-20mA Passive | 30 | 300 | 1 | 0 | 0 | IIB |

International

E7 IECEx Flame-proof

| | |
|--------------------|--|
| Certificate | IECEX FMG 10.0005X |
| Standards | IEC 60079-0:2017 IEC 60079-1:2014 IEC 60079-7:2015 + A1:2017 IEC 60079-11:2011 |
| Markings | Ex db eb [ib] IIB T4 Gb Ta = -50 °C to 70 °C; FISCO or Ex db eb [ib] IIB T4 Gb Ta = -50 °C to 70 °C; FISCO and Ex db eb [ia IIC Ga] IIB T4 Gb Ta = -50 °C to 70 °C Entity or Ex db eb [ib] IIB T4 Gb Ta = -50 °C to 70 °C; FISCO and Ex db eb ib IIB T4 Gb Ta = -50 °C to 70 °C Entity or Ex db eb ib IIB T4 Gb Ta = -50 °C to 70 °C Entity or Ex db eb ib IIB T4 Gb Ta = -50 °C to 70 °C Entity and Ex db eb [ia IIC Ga] IIB T4 Gb Ta = -50 °C to 70 °C Entity or Ex db eb [ib] IIB T4 Gb Ta = -50 °C to 70 °C Entity and Ex db eb ib IIB T4 Gb Ta = -50 °C to 70 °C Entity IP66; IP67 |

Specific Conditions of Use (X):

1. The flamepaths of the equipment are not intended to be repaired. Consult the manufacturer if repair of the flamepath joints is necessary.

| Ex marking | Comm. Bus | Uo V | Io mA | Po W | Co μF | Lo mH | Group |
|--------------------------------|--------------------|---------|----------|---------|----------|----------|-------|
| Ex db eb [ib] IIB T4 Gb | FISCO | 15 | 354 | 5.32 | - | - | IIB |
| Ex db eb [ia IIC Ga] IIB T4 Gb | HART/4-20mA Active | 23.1 | 95.3 | 0.55 | 0.14 | 3.9 | IIC |
| | | | | | 1.0 | 15 | IIB |
| | | | | | 3.67 | 33 | IIA |
| Ex db eb [ib] IIB T4 Gb | Fieldbus | 15 | 200 | 3 | 1.99 | 143 μH | IIB |

| Ex marking | Comm. Bus | Ui V | Ii mA | Pi W | Ci μF | Li mH | Group |
|-----------------------|---------------------|---------|----------|---------|----------|----------|-------|
| Ex db eb ib IIB T4 Gb | HART/4-20mA Passive | 30 | 300 | 1 | 0 | 0 | IIB |

Brazil

E2 INMETRO Flame-proof

| | |
|--------------------|---|
| Certificate | UL-BR 17.1017X |
| Standards | ABNT NBR IEC 60079-0:2013, ABNT NBR IEC 60079-1:2016, ABNT NBR IEC 60079-7:2018, ABNT NBR IEC 60079-11:2013 |
| Markings | Ex db eb [ib] IIB T4 Gb Ex db eb [ia IIC] IIB T4 Gb Ex db eb ib IIB T4 Gb Tamb= -50 °C a +70 °C IP66/IP67 |

| Ex marking | Comm. Bus | Uo V | Io mA | Po W | Co μF | Lo mH | Group |
|-----------------------------|--------------------|---------|----------|---------|----------|----------|-------|
| Ex db eb [ib] IIB T4 Gb | FISCO | 15 | 354 | 5.32 | - | - | IIB |
| Ex db eb [ia IIC] IIB T4 Gb | HART/4-20mA Active | 23.1 | 95.3 | 0.55 | 0.14 | 3.9 | IIC |
| | | | | | 1.0 | 15 | IIB |
| | | | | | 3.67 | 33 | IIA |
| Ex db eb [ib] IIB T4 Gb | Fieldbus | 15 | 200 | 3 | 1.99 | 143 μH | IIB |

| Ex marking | Comm. Bus | Ui V | Ii mA | Pi W | Ci μF | Li mH | Group |
|-----------------------|---------------------|---------|----------|---------|----------|----------|-------|
| Ex db eb ib IIB T4 Gb | HART/4-20mA Passive | 30 | 300 | 1 | 0 | 0 | IIB |

Specific Conditions of Use for Ex Equipment or Schedule of Limitations For Ex Components (X):

See certificate

China

E3 NEPSI Flame-proof

| | |
|--------------------|--|
| Certificate | GYJ20.1392X (CCC) |
| Standards | GB 3836.1 – 2010, GB 3836.2 – 2010, GB 3836.3 – 2010, GB 3836.4 – 2010, GB 3836.20 – 2010 |
| Markings | Ex d e [ib] IIB T4 Gb; Ex d e [ib] IIB T4 Gb; Ex d e [ia IIC Ga] IIB T4 Gb; Ex d e [ib] IIB T4 Gb; Ex d e ib IIB T4 Gb |

| Ex marking | Comm. Bus | Uo V | Io mA | Po W | Co μF | Lo mH | Group |
|-----------------------------|--------------------|---------|----------|---------|----------|----------|-------|
| Ex db eb [ib] IIB T4 Gb | FISCO | 15 | 354 | 5.32 | - | - | IIB |
| Ex db eb [ia IIC] IIB T4 Gb | HART/4-20mA Active | 23.1 | 95.3 | 0.55 | 0.14 | 3.9 | IIC |
| | | | | | 1.0 | 15 | IIB |
| | | | | | 3.67 | 33 | IIA |
| Ex db eb [ib] IIB T4 Gb | Fieldbus | 15 | 200 | 3 | 1.99 | 143 μH | IIB |

| Ex marking | Comm. Bus | Ui V | Ii mA | Pi W | Ci μF | Li mH | Group |
|-----------------------|---------------------|---------|----------|---------|----------|----------|-------|
| Ex db eb ib IIB T4 Gb | HART/4-20mA Passive | 30 | 300 | 1 | 0 | 0 | IIB |

Specific Conditions of Use (X):

See certificate

Technical Regulations Customs Union (EAC)

EM EAC Flame-proof

| | |
|--------------------|--|
| Certificate | RU C-SE.AA87.B.00345 |
| Markings | 1Ex d e [ib] IIB T4 Gb 1Ex d e [ia IIC Ga] IIB T4 Gb 1Ex d e IIB T4 Gb Tamb= -50 °C a +70 °C IP66/IP67 |

| Ex marking | Comm. Bus | Uo V | Io mA | Po W | Co μ F | Lo mH | Group |
|-----------------------------|--------------------|---------|----------|---------|---------------|-------------|-------|
| Ex db eb [ib] IIB T4 Gb | FISCO | 15 | 354 | 5.32 | - | - | IIB |
| Ex db eb [ia IIC] IIB T4 Gb | HART/4-20mA Active | 23.1 | 95.3 | 0.55 | 0.14 | 3.9 | IIC |
| | | | | | 1.0 | 15 | IIB |
| | | | | | 3.67 | 33 | IIA |
| Ex db eb [ib] IIB T4 Gb | Fieldbus | 15 | 200 | 3 | 1.99 | 143 μ H | IIB |

| Ex marking | Comm. Bus | Ui V | Ii mA | Pi W | Ci μ F | Li mH | Group |
|-----------------------|---------------------|---------|----------|---------|---------------|----------|-------|
| Ex db eb ib IIB T4 Gb | HART/4-20mA Passive | 30 | 300 | 1 | 0 | 0 | IIB |

Japan

E4 Japan Flame-proof

Certificate CML 17JPN2086X

Markings TANK HUB

II 2(2) G Ex db eb [ib] IIB T4 Gb Ta = -20 °C to +60 °C; IP66, IP67

TANK HUB (with Active Modem HART Board)

II 2(2) G Ex db eb [ib] IIB T4 Gb Ta = -20 °C to +60 °C, IP66 / IP6

II 2(1) G Ex db eb [ia IIC Ga] IIB T4 Gb Ta = -20 °C to +70 °C; IP66, IP67

TANK HUB (with Passive Modem HART Board)

II 2(2) G Ex db eb [ib] IIB T4 Gb Ta = -20 °C to +60 °C, IP66 / IP67

II 2 G Ex db eb ib IIB T4 Gb Ta = -20 °C to +60 °C; IP66, IP67

| Ex marking | Comm. Bus | Uo V | Io mA | Po W | Co μF | Lo mH | Group |
|--------------------------------|--------------------|---------|----------|---------|----------|----------|-------|
| Ex db eb [ib] IIB T4 Gb | FISCO | 15 | 354 | 5.32 | - | - | IIB |
| Ex db eb [ia IIC Ga] IIB T4 Gb | HART/4-20mA Active | 23.1 | 95.3 | 0.55 | 0.14 | 3.9 | IIC |
| | | | | | 1.0 | 15 | IIB |
| | | | | | 3.67 | 33 | IIA |
| Ex db eb [ib] IIB T4 Gb | Fieldbus | 15 | 200 | 3 | 1.99 | 143 μH | IIB |

| Ex marking | Comm. Bus | Ui V | Ii mA | Pi W | Ci μF | Li mH | Group |
|-----------------------|---------------------|---------|----------|---------|----------|----------|-------|
| Ex db eb ib IIB T4 Gb | HART/4-20mA Passive | 30 | 300 | 1 | 0 | 0 | IIB |

Specific Conditions of Use (X):

See certificate

Republic of Korea

EP Korea Flame-proof

Certificate 13-KB4BO-0458X, 13-KB4BO-0459X, 13-KB4BO-0460X

Markings Ex d e [ib] IIB T4
 Ex d e [ib] IIB T4, Ex d e [ia IIC] IIB T4
 Ex d e [ib] IIB T4, Ex d e ib IIB T4
 (-50 °C ≤ Ta ≤ +70 °C)

| Ex marking | Comm. Bus | Uo V | Io mA | Po W | Co μF | Lo mH | Group |
|-----------------------------|--------------------|---------|----------|---------|----------|----------|-------|
| Ex db eb [ib] IIB T4 Gb | FISCO | 15 | 354 | 5.32 | - | - | IIB |
| Ex db eb [ia IIC] IIB T4 Gb | HART/4-20mA Active | 23.1 | 95.3 | 0.55 | 0.14 | 3.9 | IIC |
| | | | | | 1.0 | 15 | IIB |
| | | | | | 3.67 | 33 | IIA |
| Ex db eb [ib] IIB T4 Gb | Fieldbus | 15 | 200 | 3 | 1.99 | 143 μH | IIB |

| Ex marking | Comm. Bus | Ui V | Ii mA | Pi W | Ci μF | Li mH | Group |
|-----------------------|---------------------|---------|----------|---------|----------|----------|-------|
| Ex db eb ib IIB T4 Gb | HART/4-20mA Passive | 30 | 300 | 1 | 0 | 0 | IIB |

India

EW CCOE Flame-proof

Certificate P380588/1

Markings Ex d e [ib] IIB T4 Gb
Ex d e [ia IIC Ga] IIB T4 Gb
Ex d e ib IIB T4 Gb

| Ex marking | Comm. Bus | Uo V | Io mA | Po W | Co μ F | Lo mH | Group |
|-----------------------------|--------------------|---------|----------|---------|---------------|-------------|-------|
| Ex db eb [ib] IIB T4 Gb | FISCO | 15 | 354 | 5.32 | - | - | IIB |
| Ex db eb [ia IIC] IIB T4 Gb | HART/4-20mA Active | 23.1 | 95.3 | 0.55 | 0.14 | 3.9 | IIC |
| | | | | | 1.0 | 15 | IIB |
| | | | | | 3.67 | 33 | IIA |
| Ex db eb [ib] IIB T4 Gb | Fieldbus | 15 | 200 | 3 | 1.99 | 143 μ H | IIB |

| Ex marking | Comm. Bus | Ui V | Ii mA | Pi W | Ci μ F | Li mH | Group |
|-----------------------|---------------------|---------|----------|---------|---------------|----------|-------|
| Ex db eb ib IIB T4 Gb | HART/4-20mA Passive | 30 | 300 | 1 | 0 | 0 | IIB |

United Arab Emirates

Flame-proof

Certificate 20-11-28736/Q20-11-001012

**Markings,
ratings,
conditions:** Same as IECEx (E7)

Additional certifications

Safety Certification (SIS)

3 Functional Safety

| | |
|--------------------|---|
| Certificate | ROS 1312032 C001 SIL 3 2-in-1 (1oo2) option (SIS-relays) |
| Standards | IEC 61508:2010 Parts 1-7 |

S Functional Safety

| | |
|--------------------|--|
| Certificate | ROS 1312032 C004 SIL 2 1-in-1 (1oo1) option, with 4-20mA or K1/K2 relay |
| Standards | IEC 61508:2010 Parts 1-7 |
| Certificate | ROS 1312032 C005 SIL 2 2-in-1 (1oo1) option, with 4-20mA or K1/K2 relay |
| Standards | IEC 61508:2010 Parts 1-7 |

Conduit plugs and adapters

IECEX Flameproof and Increased Safety

| | |
|--------------------|--|
| Certificate | IECEX UL 18.0016X |
| Standards | IEC 60079-0:2011, IEC 60079-1:2014-06, IEC 60079-7:2015, IEC 60079-31:2013 |
| Markings | Ex db eb IIC Gb Ex ta IIIC Da |

ATEX Flameproof and Increased Safety

| | |
|--------------------|---|
| Certificate | DEMKO 18ATEX1986X |
| Standards | EN60079-0:2012+A11:2013, EN60079-1:2014, IEC60079-7:2015, EN 60079-31:2014 |
| Markings |  II 2 G Ex db eb IIC Gb II 1 D Ex ta IIIC Da |

Table 7: Conduit Plug Thread Sizes

| Thread | Identification mark |
|------------|---------------------|
| M20 x 1.5 | M20 |
| ½ - 14 NPT | ½ NPT |

Table 8: Thread Adapter Thread Sizes

| Male thread | Identification mark |
|----------------|---------------------|
| M20 x 1.5 – 6g | M20 |
| ½ - 14 NPT | ½ - 14 NPT |
| Female thread | Identification mark |
| M20 x 1.5 – 6H | M20 |
| ½ - 14 NPT | ½ - 14 NPT |

Special Conditions for Safe Use (X):

1. The blanking plug shall not be used with an adapter.
2. Only one adapter shall be used with any single cable entry on the associated equipment.
3. It is the end user's responsibility to ensure that the ingress protection rating is maintained at the interface of the equipment and the blanking element/adapter.
4. Suitability of the temperature of the devices is to be determined during end-use with suitability rated equipment.

Product certifications for Emerson 775 THUM Adapter

Extract from Emerson 775 THUM Adapter Product Certifications Rev 2.7

For more information, see the Emerson Wireless 775 THUM Adapter [Product Data Sheet](#).

European directive information

A copy of the EU Declaration of Conformity can be found at the end of the Quick Start Guide. The most recent revision of the EU Declaration of Conformity can be found at Emerson.com/Rosemount.

Ordinary location certification from FM Approvals

As standard, the transmitter has been examined and tested to determine that the design meets the basic electrical, mechanical, and fire protection requirements by FM Approvals, a nationally recognized test laboratory (NRTL) as accredited by the Federal Occupational Safety and Health Administration (OSHA).

Telecommunication compliance (for wireless products only)

All wireless devices require certification to ensure that they adhere to regulations regarding the use of the RF spectrum. Nearly every country requires this type of product certification.

Emerson is working with governmental agencies around the world to supply fully compliant products and remove the risk of violating country directives or laws governing wireless device usage.

FCC and IC (for wireless products only)

This device complies with Part 15 of the FCC Rules. Operation is subject to the following conditions: This device may not cause harmful interference. This device must accept any interference received, including interference that may cause undesired operation. This device must be installed to ensure a minimum antenna separation distance of 20 cm from all persons.

Installing equipment in North America

The US National Electrical Code® (NEC) and the Canadian Electrical Code (CEC) permit the use of Division marked equipment in Zones and Zone marked equipment in Divisions. The markings must be suitable for the area classification, gas, and temperature class. This information is clearly defined in the respective codes.

USA

15 USA Intrinsically Safe (IS) and Non-incendive

| | |
|--------------------|--|
| Certificate | 3036224 |
| Standards | FM Class 3600 - 1998, FM Class 3610 - 2007, FM Class 3611 - 2004, FM Class 3810 - 2005, NEMA 250 - 2003, IEC 60529 - 2004 |
| Markings | IS CL I, DIV 1, GP A, B, C, D; CL II, DIV 1, GP E, F, G; Class III; Class 1, Zone 0, AEx ia IIC T4; NI CL I, DIV 2, GP A, B, C, D T4; T4(-50 °C ≤ T _a ≤ +70 °C) when connected per Rosemount drawing 00775-0010; Type 4X/IP66 |

Canada

I6 Canada Intrinsically Safe

| | |
|--------------------|--|
| Certificate | 2174201 |
| Standards | CAN/CSA C22.2 No. 0-M91 (R2001), CAN/CSA C22.2 No. 94-M91 (R2001), CSA Std C22.2 No. 142-M1987, CAN/CSA C22.2 No.157-92, CSA Std C22.2 No. 213-M1987, C22.2 No. 60529 |
| Markings | Intrinsically Safe Class I, Division 1, Groups A, B, C, D T3C; Suitable for use in Class I, Division 2, Groups A, B, C, D T3C; T3C(-50 °C ≤ T _a ≤ +70 °C) when installed per Rosemount drawing 00775-0012; Type 4X/IP66 |

Europe

I1 ATEX Intrinsic Safety

| | |
|--------------------|---|
| Certificate | Baseefa09ATEX0125X |
| Standards | IEC 60079-0:2011; EN60079-11:2012; |
| Markings | ⊕ II 1G Ex ia IIC T4 Ga, T4(-50 °C ≤ T _a ≤ +70 °C) |

Special Conditions for Safe Use (X):

1. The surface resistivity of the antenna is greater than 1GΩ. To avoid electrostatic charge build-up, it must not be rubbed or cleaned with solvents or dry cloth.
2. The Rosemount 775 enclosure may be made of aluminum alloy and given a protective polyurethane paint finish; however, care should be taken to protect it from impact or abrasion if located in zone 0.

N1 ATEX Type n

| | |
|--------------------|--|
| Certificate | Baseefa09ATEX0131 |
| Standards | IEC 60079-0:2012 + A11:2013, EN 60079-15:2010; |
| Markings | ⊕ II 3G Ex nA IIC T4 Gc, T4(-50 °C ≤ T _a ≤ +70 °C) IP66 |

International

I7 IECEx Intrinsic Safety

| | |
|--------------------|--|
| Certificate | IECEx BAS 09.0050X |
| Standards | IEC 60079-0:2011, IEC 60079-11:2011 |
| Markings | Ex ia IIC T4 Ga, T4(-50 °C ≤ T _a ≤ +70 °C) IP66 |

Special Conditions for Safe Use (X):

1. The surface resistivity of the antenna is greater than 1 GΩ. To avoid electrostatic charge build-up, it must not be rubbed or cleaned with solvents or dry cloth.
2. The Rosemount 775 enclosure may be made of aluminum alloy and given a protective polyurethane paint finish; however, care should be taken to protect it from impact or abrasion if located in zone 0.

N7 IECEx Type n

| | |
|--------------------|--|
| Certificate | IECEX BAS 09.0058 |
| Standards | IEC 60079-0:2011, IEC 60079-15:2010; |
| Markings | Ex nA IIC T4 Gc, T4(-50 °C ≤ T _a ≤ +70 °C) IP66 |

Brazil

I2 INMETRO Intrinsic Safety

| | |
|--------------------|--|
| Certificate | UL-BR 15.0089X |
| Standards | ABNT NBR IEC 60079-0:2013, ABNT NBR IEC 60079-11:2013 |
| Markings | Ex ia IIC T4 Ga (-50 °C ≤ T _a ≤ +70 °C), IP66 |

Special Conditions for Safe Use (X):

1. The surface resistivity of the antenna is greater than 1 GΩ. To avoid electrostatic charge build-up, it must not be rubbed or cleaned with solvents or dry cloth.
2. The enclosure may be made of aluminum alloy and given a protective polyurethane paint finish; special care must be taken to minimize the risk of impact or friction of the housing which can cause the generation of sparks.

N2 INMETRO Type n

| | |
|--------------------|--|
| Certificate | UL-BR 15.0027 |
| Standards | ABNT NBR IEC 60079-0:2008 + Errata 1:2011, IEC 60079-15:2012 |
| Markings | Ex nA IIC T4 Gc (-50 °C ≤ T _a ≤ +70 °C) IP66 |

China

I3 NEPSI 本质安全

| | |
|-------------|--|
| 证书 | GYJ20.1388X (CCC 认证) |
| 所用标准 | GB3836.1 – 2010, GB3836.4 – 2010, GB3836.20-2010 |
| 标志 | Ex ia IIC T4 Ga, -50 ~ +70 °C |

特殊使用条件(X):

1. 产品外壳含有轻金属，用于 0 区时需注意防止由于冲击或摩擦产生的点燃危险。
2. 产品天线部分表面电阻大于 1GΩ，使用时须防止产生静电火花，只能用湿布清理。

使用注意事项

1. 产品使用环境温度为：-50 ~ +70 °C
2. 本安电气参数：

| 最高输入电压 U_i (V) | 最大输入电流 I_i (mA) | 最大输入功率 P_i (W) | 最大内部等效参数 | |
|------------------|-------------------|------------------|------------|------------|
| | | | C_i (nF) | L_i (mH) |
| 30 | 200 | 1 | 0 | 0 |

3. 该产品必须与已通过防爆认证的关联设备配套共同组成本防爆系统方可使用于爆炸性气体环境。其系统接线必须同时遵守本产品和所配关联设备的使用说明书要求，接线端子不得接错。
4. 用户不得自行更换该产品的零部件，应会同产品制造商共同解决运行中出现的故障，以杜绝损坏现象的发生。
5. 产品的安装、使用和维护应同时遵守产品使用说明书、GB3836.13-2013“爆炸性环境 第 13 部分：设备的修理、检修、修复和改造”、GB/T3836.15-2017“爆炸性环境 第 15 部分：电气装置的设计、选型和安装”、GB/T3836.16-2017“爆炸性环境 第 16 部分：电气装置的检查与维护”、GB/T 3836.18-2017“爆炸性环境 第 18 部分：本质安全电气系统”、GB50257-2014“电气装置安装工程爆炸和火灾危险环境电力装置施工及验收规范”的有关规定。

Japan

I4 CML Intrinsically Safe

Certificate CML19JPN2107X

Markings Ex ia IIC T4 Ga, -50 °C~ +70 °C

Special Conditions for Safe Use (X):

1. See certificate for special conditions.

EAC - Belarus, Kazakhstan, Russia

IM Technical Regulation Customs Union (EAC) Intrinsic Safety

Certificate TC RU C-US.AA87.B.00993

Markings 0Ex ia IIC T4 Ga X; T4 (-50 °C ≤ T_a ≤ +70 °C) IP66

Special Conditions for Safe Use (X):

1. See certificate for special conditions.

Republic of Korea

IP Korea (KOSHA) Intrinsic Safety

Certificate 10-KB4BO-0010X

Markings Ex ia IIC T4

Special Conditions for Safe Use (X):

1. See certificate for special conditions.

India

IW India (CCOE) Intrinsic Safety

Certificates A/P/HQ/MH/104/4259(P366317)

Markings Ex ia IIC T4

Dimensional drawings

Figure 14: Rosemount 2410 Tank Hub Dimensions

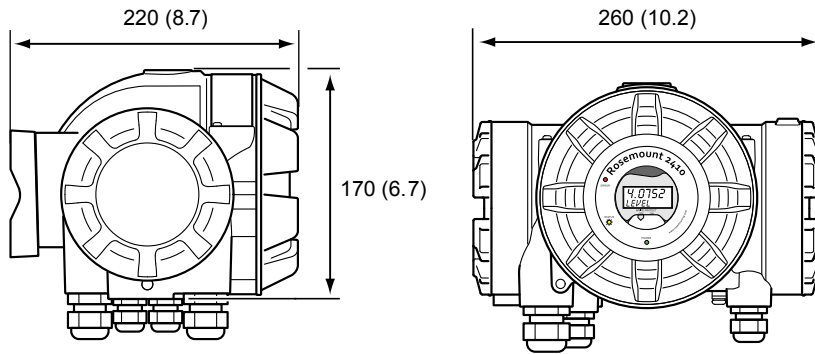

Dimensions are in millimeters (inches).

Figure 15: Rosemount 2410 Tank Hub Mounting

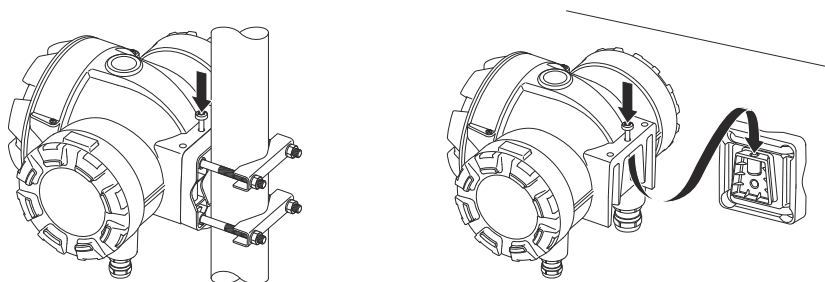

Rosemount 2410 can be mounted on a wall or a pipe with 33.4-60.3 mm (1-2 in.) diameter.

Figure 16: Emerson Wireless 775 THUM Adapter Assembly Dimensions

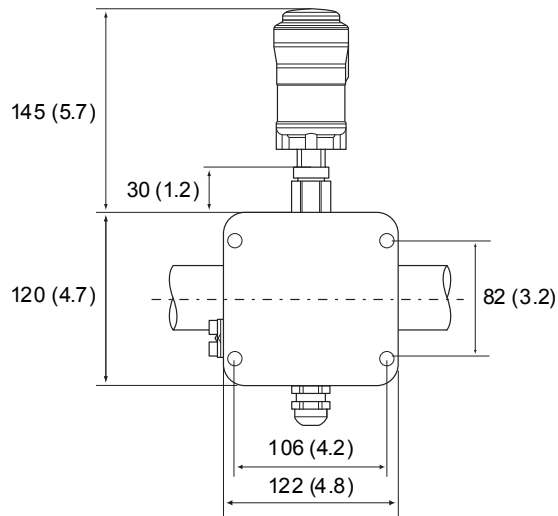

Dimensions are in millimeters (inches).

Figure 17: Emerson Wireless 775 THUM Adapter Assembly Mounting

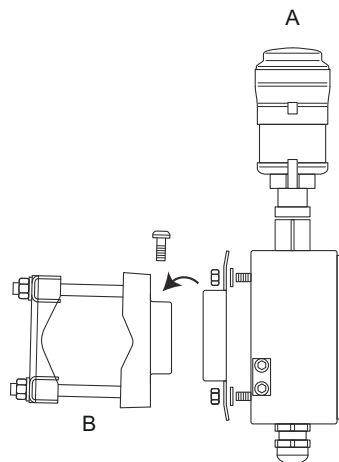

- A. Vertical orientation of THUM Adapter
- B. Mounting kit for vertical or horizontal installation; fits 33.4-60.3 mm (1-2 in.) pipe diameter

For more information: www.emerson.com

©2021 Emerson. All rights reserved.

Emerson Terms and Conditions of Sale are available upon request. The Emerson logo is a trademark and service mark of Emerson Electric Co. Rosemount is a mark of one of the Emerson family of companies. All other marks are the property of their respective owners.

ROSEMOUNT™

