

Rosemount™ 214C Sensor



Contents

About this guide.....	3
Wiring diagram for RTDs.....	5
Wiring diagram for thermocouples.....	6
Additional RTD specifications.....	7
Additional thermocouple specifications.....	9
Product certifications.....	10
Declaration of Conformity.....	25
China RoHS.....	27

1 About this guide

This guide provides basic guidelines for Rosemount 214C Sensor models. If the sensor was ordered assembled to a temperature thermowell or transmitter, see the appropriate product literature for information on configuration and hazardous locations certifications.

1.1 Safety messages

NOTICE

Complications can arise when the sensors and the transmitters to which they are assembled are certified to compatible, but each has different approvals. Be aware of the following situations:

- If an I.S. approved Rosemount 214C Sensor is ordered with a housing, a transmitter enclosed in that housing may have a different I.S. approval rating. Refer to the transmitter IS certificate if applicable.
- If a sensor and transmitter have different certifications, or if either has more certifications than the other, installation must comply with the most restrictive requirements required by either component. This is especially (but not exclusively) relevant when combination approvals are ordered on either the sensor or transmitter. Review certifications on both the sensor and transmitter for installation requirements and ensure installation of the sensor/transmitter assembly complies with a single certification that is shared by both of these components and that meets the requirements of the application.

▲ WARNING

Explosion

Explosions could result in death or serious injury.

Installation of sensor in an explosive environment must be in accordance with appropriate local, national, and international standards, codes, and practices.

⚠ WARNING**Conduit/cable entries**

Unless marked, the conduit/cable entries in the housing use a ½-14 NPT thread form. Entries marked "M20" are M20 × 1.5 thread form. On devices with multiple conduit entries, all entries will have the same thread form. Only use plugs, adapters, glands, or conduit with a compatible thread form when closing these entries.

When installing in a hazardous location, use only appropriately listed or Ex certified plugs, glands, or adapters in cable/conduit entries.

Only use plugs, adapters, glands, or conduit with a compatible thread form when closing these entries.

Physical access

Unauthorized personnel may potentially cause significant damage to and/or misconfiguration of end users' equipment. This could be intentional or unintentional and needs to be protected against.

Physical security is an important part of any security program and fundamental in protecting your system. Restrict physical access by unauthorized personnel to protect end users' assets. This is true for all systems used within the facility.

⚠ CAUTION

Refer to Product Certification section of this Quick Start Guide documentation.

2 Wiring diagram for RTDs

Figure 2-1: RTD Lead Wire Configuration per IEC 60751 - Single Element

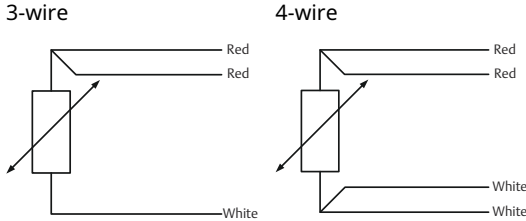

Note

To configure a single element, 4-wire RTD as a 3-wire system, connect only one white lead. Insulate or terminate the unused white lead in a manner that prevents shorting to the ground. To configure a single element, 4-wire RTD as a 2-wire system, connect matching colored wires first and then connect the paired wires to the terminal.

Figure 2-2: RTD Lead Wire Configuration per IEC 60751 - Dual Element

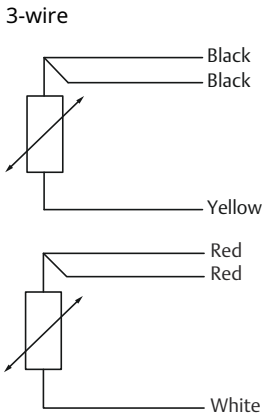

3 Wiring diagram for thermocouples

Figure 3-1: Thermocouple Lead Wire Configuration

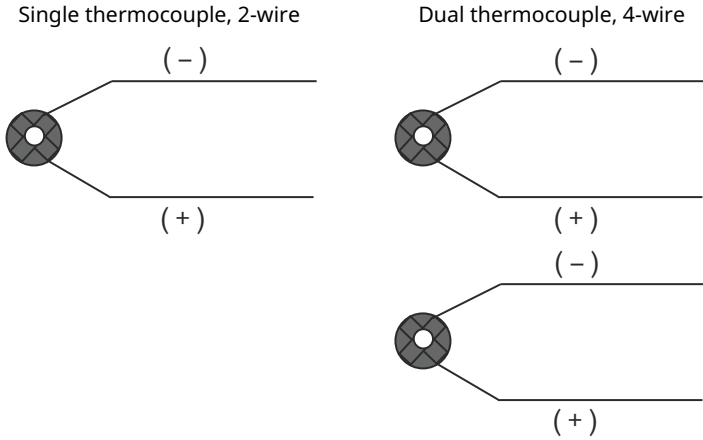

Table 3-1: Thermocouple Wire Color

Type	IEC 60584 Thermocouple		ASTM E230 Thermocouple	
	POS (+)	NEG (-)	POS (+)	NEG (-)
J	Black	White	White	Red
K	Green	White	Yellow	Red
T	Brown	White	Blue	Red

Note

Dual thermocouple sensors are shipped with one pair of the wires shrink-wrapped together.

4 Additional RTD specifications

Note

All specifications in this section apply to all RTDs unless noted otherwise. All RTDs meet and/or exceed type and routine tests for sensors/thermometers per IEC 60751:2008.

4.1 Insulation resistance

1000 M Ω minimum insulation resistance when measured at 500 VDC at room temperature.

4.2 Insulation resistance at elevated temperature

Insulation resistance at elevated temperatures for sensor types RT, RH, and RW are tested and meet requirements according to IEC 60751:2008 6.5.1.

4.3 Time response

Sensor response time tested in flowing water according to IEC 60751:2008 6.5.2.

Sensor type RT: T50 average = 8.5 seconds; T90 average = 22.9 seconds

Sensor type RH: T50 average = 9.15 seconds; T90 average = 24.1 seconds

Sensor type RW: T50 average = 9.0 seconds; T90 average = 24.4 seconds

4.4 Stability

Stability at upper temperature limit tested and meets requirements according to IEC 60751:2008 6.5.3.

4.5 Effects of temperature cycling

Effect of temperature cycling tested and meets requirements according to IEC 60751:2008 6.5.5.

4.6 Hysteresis

Effect of hysteresis tested and meets requirements according to IEC 60751:2008 6.5.6.

4.7 Self heating

Self-heating tested and meets requirements according to IEC 60751:2008 6.5.7.

4.8 Process immersion

Minimum immersion depth tested according to IEC 60751:2008 6.5.8.

Sensor type RT, single: Minimum immersion depth = 30 mm

Sensor type RT, dual: Minimum immersion depth = 45 mm

Sensor type RH, single and dual: Minimum immersion depth = 40 mm

Sensor type RW, single and dual: Minimum immersion depth = 50 mm

4.9 Vibration limits

Vibration tested according to IEC 60751:2008 6.6.4.

Sensor type RT or RH ordered with VR1: Meets 10 g vibration between 20 and 500 Hz for 150 hours.

Sensor type RT and RH: Meets 3 g vibration between 20 and 500 Hz for 150 hours.

Sensor type RW: Meets 1 g vibration between 20 and 500 Hz for 150 hours.

4.10 Functional specifications

Power	Overvoltage Category I
Environmental	Pollution Degree 4

5 Additional thermocouple specifications

Note

All specifications in this section apply to all thermocouple types unless noted otherwise. All thermocouples meet and/or exceed type and routine tests for sensors/thermometers per IEC 61515:2016.

5.1 Insulation resistance

1000 MΩ minimum insulation resistance when measured at 500 VDC at room temperature.

5.2 Time response

Sensor response time tested in flowing water according to IEC 61515:2016 5.3.2.8.

Grounded: T50 average = 1.9 seconds; T90 average = 4.0 seconds

Ungrounded: T50 average = 2.8 seconds; T90 average = 7.3 seconds

5.3 Process immersion

Minimum immersion depth tested according to IEC 60751:2008 6.5.8.

Grounded thermocouples: Minimum immersion depth = 5 mm

Ungrounded thermocouples: Minimum immersion depth = 10 mm

5.4 Continuity

Electrical continuity and polarity are tested and meet requirements according to IEC 61515:2016 5.3.2.

5.5 Functional specifications

Power	Overvoltage Category I
Environmental	Pollution Degree 4

6 Product certifications

Rev 2.16

European Directive information

A copy of the EU Declaration of Conformity can be found at the end of the Quick Start Guide. The most recent revision of the EU Declaration of Conformity can be found at [Emerson.com/Rosemount](https://www.emerson.com/Rosemount).

Ordinary Location Certification

The Rosemount 214C has been examined and tested to determine that the design meets the basic electrical, mechanical, and fire protection requirements by a nationally recognized test laboratory (NRTL) as accredited by the Federal Occupational Safety and Health Administration (OSHA).

Note

The terminal strip in the Aluminum with Terminal Strip (AT1 or AT3) connection head requires sensor lead wires to have a wire termination (Ex: Bootlace ferrule or spade lug).

North America

The US National Electrical Code® (NEC) and the Canadian Electrical Code (CEC) permit the use of Division marked equipment in Zones and Zone marked equipment in Divisions. The markings must be suitable for the area classification, gas, and temperature class. This information is clearly defined in the respective codes.

6.1 North America

6.1.1 E5 USA Explosionproof (XP) and Dust-Ignitionproof (DIP)

Certificate 70044744

Standards FM 3600:2011, FM 3615:2006, UL 50E:2007, UL 61010-1:2010, ANSI/ISA 60529:2004

Markings XP CL I, DIV 1, GP B, C, D; DIP CL II, DIV 1, GP E, F, G; CL III; T6 (-50 °C ≤ T_a ≤ +80 °C), T5 (-50 °C ≤ T_a ≤ +95 °C); Seal not required; installed per Rosemount drawing 00214-1030; Type 4X[†] and IP 66/67; V_{max} 35 VDC, 750 mW_{max}

Special Conditions for Safe Use (X):

1. Flameproof joints are not intended for repair.

2. Cable entries must be used which maintain the ingress protection of the enclosure. Unused cable entries must be filled with suitable blanking plugs.

6.1.2 N5 USA Division 2 (NI)

Certificate 70044744

Standards FM 3600:2011, FM 3611:2004, UL 50E:2007, UL 61010-1:2010, ANSI/ISA 60529:2004

Markings NI CL I, DIV 2, GP A, B, C, D; T6 ($-50\text{ °C} \leq T_a \leq +80\text{ °C}$), T5 ($-50\text{ °C} \leq T_a \leq +95\text{ °C}$); installed per Rosemount drawing 00214-1030; Type 4X[†] and IP 66/67; V_{\max} 35 VDC, 750 mW_{\max}

6.1.3 E6 Canada Explosionproof (XP) and Dust-Ignitionproof (DIP)

Certificate 70044744

Standards CAN/CSA C22.2 No. 0:2010, CAN/CSA No. 25-1966 (R2000), CAN/CSA C22.2 No. 30-M1986 (R2012), CAN/CSA C22.2 No. 94-M1991 (R2011), CAN/CSA C22.2 No. 61010-1:2012

Markings XP CL I, DIV 1, GP B*, C, D; DIP CL II, DIV 1, GP E, F, G; CL III; T6 ($-50\text{ °C} \leq T_a \leq +80\text{ °C}$), T5 ($-50\text{ °C} \leq T_a \leq +95\text{ °C}$); Seal not required; installed per Rosemount drawing 00214-1030; Type 4X[†] and IP 66/67; V_{\max} 35 VDC, 750 mW_{\max}

Special Conditions for Safe Use (X):

1. Flameproof joints are not intended for repair.
2. Cable entries must be used which maintain the ingress protection of the enclosure. Unused cable entries must be filled with suitable blanking plugs.

6.1.4 N6 Canada Division 2

Certificate 70044744

Standards CAN/CSA C22.2 No. 0:2010, CAN/CSA C22.2 No. 94-M1991 (R2011), CAN/CSA No. 213-M1987 (R2013), CAN/CSA C22.2 No. 61010-1:2012

Markings CL I, DIV 2, GP A, B, C, D; T6; ($-50\text{ °C} \leq T_a \leq +80\text{ °C}$), T5 ($-50\text{ °C} \leq T_a \leq +95\text{ °C}$); installed per Rosemount drawing 00214-1030; Type 4X[†] and IP 66/67; V_{\max} 35 VDC, 750 mW_{\max}

†Spring loaded indicator has reduced ingress and dust ratings. Spring loaded sensors must be installed in a thermowell to maintain dust and ingress ratings. Un-painted aluminum enclosures are Type 4 rated. *Assembly is not Canada Explosionproof (E6) rated to Group B if the AT1 (Aluminum with Terminal Strip) connection head is used.

6.2 Europe

6.2.1 E1 ATEX Flameproof

Certificate DEKRA 19ATEX0076 X

Standards EN IEC 60079-0: 2018, EN 60079-1: 2014

Markings  II 2 G Ex db IIC T6...T1 Gb, (-60 °C ≤ T_a ≤ +80 °C)

Special Conditions for Safe Use (X):

1. Flameproof joints are not intended for repair.
2. Non-Standard Paint options may cause risk from electrostatic discharge. Avoid installations that cause electrostatic build-up on painted surfaces, and only clean the painted surfaces with a damp cloth. If paint is ordered through a special option code, contact the manufacturer for more information.
3. When provided on their own, the adapter style sensors must be assembled to a suitable Ex db enclosure with a free internal volume no greater than 550 cm³.
4. Guard DIN sensors against impacts greater than 4 J.

Process temperature range (°C) ⁽¹⁾	Ambient temperature range (°C) ⁽¹⁾	Temperature class
-60 °C to +80 °C	-60 °C to +80 °C	T6
-60 °C to +95 °C	-60 °C to +80 °C	T5
-60 °C to +130 °C	-60 °C to +80 °C	T4
-60 °C to +195 °C	-60 °C to +80 °C	T3
-60 °C to +290 °C	-60 °C to +80 °C	T2
-60 °C to +440 °C	-60 °C to +80 °C	T1

(1) Min. process temperature and min. ambient temperature is limited to -50 °C for models with enclosure designation "AD1" or "SD1".

6.2.2 I1 ATEX Intrinsic Safety

Certificate Baseefa16ATEX0101X

Standards EN IEC 60079-0:2018, EN 60079-11:2012

Markings Ⓢ II 1 G Ex ia IIC T5/T6 Ga (SEE CERTIFICATE FOR SCHEDULE)

Thermocouples; P _i = 500 mW	T6 -60 °C ≤ T _a ≤ +70 °C
RTDs; P _i = 192 mW	T6 -60 °C ≤ T _a ≤ +70 °C
RTDs; P _i = 290 mW	T6 -60 °C ≤ T _a ≤ +60 °C
	T5 -60 °C ≤ T _a ≤ +70 °C

Special Condition for Safe Use (X):

The equipment must be installed in an enclosure which affords it a degree of ingress protection of at least IP20.

6.2.3 N1 ATEX Zone 2

Certificate BAS00ATEX3145

Standards EN 60079-0:2012+A11:2013, EN 60079-15:2010

Markings Ⓢ II 3 G Ex nA IIC T5 Gc (-40 °C ≤ T_a ≤ 70 °C)

6.2.4 ND ATEX Dust Ignitionproof

Certificate DEKRA 19ATEX0076 X

Standards EN IEC 60079-0:2018, EN 60079-31:2014

Markings Ⓢ II 2 D Ex tb IIIC T130 °C Db, (-60 °C ≤ T_a ≤ +80 °C)

Special Conditions for Safe Use (X):

1. Non-Standard Paint options may cause risk from electrostatic discharge. Avoid installations that cause electrostatic build-up on painted surfaces, and only clean the painted surfaces with a damp cloth. If paint is ordered through a special option code, contact the manufacturer for more information.
2. When provided on their own, the adapter style sensors must be assembled to a suitable Ex tb enclosure with a free internal volume no greater than 550 cm³.
3. The spring loaded adapter style sensors and DIN style sensors must be installed in a thermowell to maintain Ex tb protection.

4. The contact indicating adapter style sensor does not meet the requirements for type of protection "tb".

Process temperature range (°C) ⁽¹⁾	Ambient temperature range (°C) ⁽¹⁾	Maximum surface temperature "T"
-60 °C to +100 °C	-60 °C to +80 °C	T130 °C

(1) Min. process temperature and min. ambient temperature is limited to -50 °C for models with enclosure designation "AD1" or "SD1".

6.3 International

6.3.1 E7 IECEx Flameproof

Certificate IECEx DEK 19.0041X

Standards IEC 60079-0: 2017, IEC 60079-1: 2014

Markings Ex db IIC T6...T1 Gb (-60 °C ≤ T_a ≤ +80 °C)

Special Conditions for Safe Use (X):

1. Flameproof joints are not intended for repair.
2. Non-Standard Paint options may cause risk from electrostatic discharge. Avoid installations that cause electrostatic build-up on painted surfaces, and only clean the painted surfaces with a damp cloth. If paint is ordered through a special option code, contact the manufacturer for more information.
3. When provided on their own, the adapter style sensors must be assembled to a suitable Ex db enclosure with a free internal volume no greater than 550 cm³.
4. Guard DIN sensors against impacts greater than 4 J.

Process temperature range (°C) ⁽¹⁾	Ambient temperature range (°C) ⁽¹⁾	Temperature class
-60 °C to +80 °C	-60 °C to +80 °C	T6
-60 °C to +95 °C	-60 °C to +80 °C	T5
-60 °C to +130 °C	-60 °C to +80 °C	T4
-60 °C to +195 °C	-60 °C to +80 °C	T3
-60 °C to +290 °C	-60 °C to +80 °C	T2

-60 °C to +440 °C	-60 °C to +80 °C	T1
-------------------	------------------	----

(1) *Min. process temperature and min. ambient temperature is limited to -50 °C for models with enclosure designation “AD1” or “SD1”.*

6.3.2 I7 IECEx Intrinsic Safety

Certificate IECEx BAS 16.0077X

Standards IEC 60079-0:2017, IEC 60079-11:2011

Markings Ex ia IIC T5/T6 Ga (SEE CERTIFICATE FOR SCHEDULE)

Thermocouples; P _i = 500 mW	T6 -60 °C ≤ T _a ≤ +70 °C
RTDs; P _i = 192 mW	T6 -60 °C ≤ T _a ≤ +70 °C
RTDs; P _i = 290 mW	T6 -60 °C ≤ T _a ≤ +60 °C
	T5 -60 °C ≤ T _a ≤ +70 °C

Special Condition for Safe Use (X):

The equipment must be installed in an enclosure which affords it a degree of ingress protection of at least IP20.

6.3.3 N7 IECEx Zone 2

Certificate IECEx BAS 07.0055

Standards IEC 60079-0:2011, IEC 60079-15:2010

Markings Ex nA IIC T5 Gc; T5 (-40 °C ≤ T_a ≤ +70 °C)

6.3.4 NK IECEx Dust Ignitionproof

Certificate IECEx DEK 19.0041X

Standards IEC 60079-0:2017 and IEC 60079-31:2013

Markings Ex tb IIIC T130 °C Db, (-60 °C ≤ T_a ≤ +80 °C)

Special Conditions for Safe Use (X):

1. Non-Standard Paint options may cause risk from electrostatic discharge. Avoid installations that cause electrostatic build-up on painted surfaces, and only clean the painted surfaces with a damp cloth. If paint is ordered through a special option code, contact the manufacturer for more information.

2. When provided on their own, the adapter style sensors must be assembled to a suitable Ex tb enclosure with a free internal volume no greater than 550 cm³.
3. The spring loaded adapter style sensors and DIN style sensors must be installed in a thermowell to maintain Ex tb protection. The contact indicating adapter style sensor does not meet the requirements for type of protection "tb".

Process temperature range (°C) ⁽¹⁾	Ambient temperature range (°C) ⁽¹⁾	Maximum surface temperature "T"
-60 °C to +100 °C	-60 °C to +80 °C	T130 °C

(1) *Min. process temperature and min. ambient temperature is limited to -50 °C for models with enclosure designation "AD1" or "SD1".*

6.4 Brazil

6.4.1 E2 Brazil Flameproof & Dust

Certificate UL-BR 21.1296X

Standards ABNT NBR IEC 60079-0:2020, ABNT NBR IEC 60079-1:2016, ABNT NBR IEC 60079-31:2014

Markings Ex db IIC T6...T1 Gb; T6...T1 (-60 °C ≤ T_a ≤ +80°C), Ex tb IIIC T130°C Db ; (-60 °C ≤ T_a ≤ +80 °C)

Special Conditions for Safe Use (X):

1. Flameproof joints are not intended for repair.
2. Non-Standard Paint options may cause risk from electrostatic discharge.
Avoid installations that cause electrostatic build-up on painted surfaces, and only clean the painted surfaces with a damp cloth. If paint is ordered through a special option code, contact the manufacturer for more information.
3. When provided on their own, the adapter style sensors must be assembled to a suitable Ex db or Ex tb enclosure with a free internal volume no greater than 550 cm³.
4. The spring loaded adapter style sensors and DIN style sensors must be installed in a thermowell to maintain Ex tb protection.
5. The contact indicating adapter style sensor does not meet the requirements for type of protection "tb".

6. Guard DIN sensors against impacts greater than 4J.

Process temperature range (°C) ¹	Ambient temperature Range (°C) ¹	Temperature class / maximum surface temperature "T" ¹
-60 °C to +80 °C	-60 °C to +80 °C	T6
-60 °C to +95 °C	-60 °C to +80 °C	T5
-60 °C to +130 °C	-60 °C to +80 °C	T4
-60 °C to +195 °C	-60 °C to +80 °C	T3
-60 °C to +290 °C	-60 °C to +80 °C	T2
-60 °C to +440 °C	-60 °C to +80 °C	T1
-60 °C to +100 °C	-60 °C to +80 °C	T130 °C
¹ Min. process temperature and min. ambient temperature is limited to -50 °C for models with enclosure designation "AD1" or "SD1".		

6.4.2 I2 Brazil Intrinsic Safety

Certificate UL-BR 18.0257X

Standards ABNT NBR IEC 60079-0:2013, ABNT NBR IEC 60079-11:2013

Markings Ex ia IIC T6...T5 Ga Thermocouples: P_i = 500 mW, T6 (-60 °C ≤ T_a ≤ +70 °C) RTDs: P_i = 192 mW, T6 (-60 °C ≤ T_a ≤ +70 °C) P_i = 290 mW, T6 (-60 °C ≤ T_a ≤ +60 °C), T5 (-60 °C ≤ T_a ≤ +70 °C)

Special Condition for Safe Use (X):

The equipment must be installed in an enclosure which affords it a degree of ingress protection of at least IP20.

6.5 China

6.5.1 E3 China Flameproof

Certificate GYJ22.1915X (CCC 认证)

Standards GB/T 3836.1-2021, GB/T 3836.2-2021, GB/T 3836.31-2021

Markings Ex db IIC T6...T1 Gb, Ex tb IIIC T130 °C Db

*Dust Ignitionproof approvals/markings are only available through the K3 option code.

产品安全使用特殊条件

证书编号后缀“X”表明产品具有安全使用特殊条件：

1. 涉及隔爆接合面的维修须联系产品制造商。
2. 传感器必须配备内部自由空间不超过 550cm³ 的 Ex db 或 Ex tb 型外壳。
3. Spring loaded 型和 DIN 型传感器需要安装于套管内以实现 Ex tb 防爆型式。
4. Contact indicating adapter 型传感器不符合 Ex tb 防爆型式。
5. DIN 型传感器需要防止 4 J 以上能量的冲击。
6. 产品温度组别和使用环境温度及过程温度之间的关系为：

过程温度	环境温度	温度组别
$-60\text{ }^{\circ}\text{C} \leq T_a \leq +80\text{ }^{\circ}\text{C}$	$-60\text{ }^{\circ}\text{C} \leq T_a \leq +80\text{ }^{\circ}\text{C}$	T6
$-60\text{ }^{\circ}\text{C} \leq T_a \leq +95\text{ }^{\circ}\text{C}$	$-60\text{ }^{\circ}\text{C} \leq T_a \leq +80\text{ }^{\circ}\text{C}$	T5
$-60\text{ }^{\circ}\text{C} \leq T_a \leq +130\text{ }^{\circ}\text{C}$	$-60\text{ }^{\circ}\text{C} \leq T_a \leq +80\text{ }^{\circ}\text{C}$	T4
$-60\text{ }^{\circ}\text{C} \leq T_a \leq +195\text{ }^{\circ}\text{C}$	$-60\text{ }^{\circ}\text{C} \leq T_a \leq +80\text{ }^{\circ}\text{C}$	T3
$-60\text{ }^{\circ}\text{C} \leq T_a \leq +290\text{ }^{\circ}\text{C}$	$-60\text{ }^{\circ}\text{C} \leq T_a \leq +80\text{ }^{\circ}\text{C}$	T2
$-60\text{ }^{\circ}\text{C} \leq T_a \leq +440\text{ }^{\circ}\text{C}$	$-60\text{ }^{\circ}\text{C} \leq T_a \leq +80\text{ }^{\circ}\text{C}$	T1
$-60\text{ }^{\circ}\text{C} \leq T_a \leq +100\text{ }^{\circ}\text{C}$	$-60\text{ }^{\circ}\text{C} \leq T_a \leq +80\text{ }^{\circ}\text{C}$	T130 °C

注：选择 AD1、SD1 外壳时环境温度下限为-50 °C。

• 产品使用注意事项

1. 产品外壳设有接地端子，用户在使用时应可靠接地。
2. 安装现场应不存在对产品外壳有腐蚀作用的有害气体。
3. 现场安装时，电缆引入口须选用经国家指定的防爆检验机构检验认可、具有 Ex db II C Gb、Ex tb III C Db 防爆等级的电缆引入装置或堵封件，冗余电缆引入口须用堵封件有效密封。
4. 用于爆炸性气体环境中，现场安装、使用和维护必须严格遵守“断电后开盖！”的警告语。
5. 用于爆炸性粉尘环境中，产品外壳表面需保持清洁，以防粉尘堆积，但严禁用压缩空气吹扫。
6. 用户不得自行更换该产品的零部件，应会同产品制造商共同解决运行中出现的故障，以杜绝损坏现象的发生。
7. 产品的安装、使用和维护应同时遵守产品使用说明书、GB/T3836.13-2021“爆炸性环境 第 13 部分：设备的修理、检修、

修复和改造”、GB/T3836.15-2017“爆炸性环境 第 15 部分：电气装置的设计、选型和安装”、GB/T3836.16-2017“爆炸性环境 第 16 部分：电气装置的检查与维护”、GB50257-2014“电气装置安装工程爆炸和火灾危险环境电力装置施工及验收规范”和 GB15577-2018“粉尘防爆安全规程”的有关规定。

6.5.2 I3 China Intrinsic Safety

Certificate GYJ22.3551X (CCC 认证)

Standards GB/T 3836.1-2021, GB/T 3836.4-2021, GB 3836.20-2010

Markings Ex ia IIC T6…T5 Ga

产品安全使用特殊条件

证书编号后缀“X”表明产品具有安全使用特殊条件：产品必须安装于具有 IP20 外壳防护等级的外壳内方可使用。

产品使用注意事项

1. 产品使用环境温度和温度组别的关系为：

传感器类型	最大输入功率 P_i (mW)	温度组别	使用环境温度
热电偶	500	T6	-60 °C ~ +70 °C
RTD	192	T6	-60 °C ~ +70 °C
RTD	290	T6	-60 °C ~ +60 °C
		T5	-60 °C ~ +70 °C

2. 本安电气参数：

热电偶：

最高输入电压	最大输入电流	最大输入功率	最大内部等效参数	
U_i (V)	I_i (mA)	P_i (mW)	C_i (pF)	L_i (nH)
60	100	500	75	600

最高输出电压	最大输出电流	最大输出功率
U_o (V)	I_o (mA)	P_o (mW)
0.1	50	25

RTD:

最高输入电压	最大输入电流	最大输入功率	最大内部等效参数	
U_i (V)	I_i (mA)	P_i (mW)	C_i (pF)	L_i (nH)
60	100	192/290	75	600

3. 该产品必须与已通过防爆认证的关联设备配套共同组成本防爆系统方可使用于爆炸性气体环境。其系统接线必须同时遵守本产品 and 所配关联设备的使用说明书要求，接线端子不得接错。
4. 用户不得自行更换该产品的零部件，应会同产品制造商共同解决运行中出现的故障，以杜绝损坏现象的发生。
5. 产品的安装、使用和维护应同时遵守产品使用说明书、GB/T3836.13-2021“爆炸性环境 第 13 部分：设备的修理、检修、修复和改造”、GB/T3836.15-2017“爆炸性环境 第 15 部分：电气装置的设计、选型和安装”、GB/T3836.16-2017“爆炸性环境 第 16 部分：电气装置的检查与维护”和 GB50257-2014“电气装置安装工程爆炸和火灾危险环境电力装置施工及验收规范”的有关规定。

6.6 Japan

6.6.1 E4 Japan Flameproof

Certificate CML 21JPN1842X

Markings Ex db IIC T6...T1 Gb, (-60°C ≤ T_a ≤ +80 °C)

Special Conditions for Safe Use (X):

1. Flameproof joints are not intended for repair.
2. Non-Standard Paint options may cause risk from electrostatic discharge. Avoid installations that cause electrostatic build-up on painted surfaces, and only clean the painted surfaces with a damp cloth. If paint is ordered through a special option code, contact the manufacturer for more information.
3. See instructions for relation between process temperature, ambient temperature and temperature class.

Additional Special Conditions for Safe Use (X) when “XA” designation is ordered:

1. When provided on their own, the adapter style sensors must be assembled to a suitable Ex db enclosure with a free internal volume no greater than 550 cm³.
2. Guard DIN sensors against impacts greater than 4 J.

Process temperature range (°C) ⁽¹⁾	Ambient temperature range (°C) ⁽¹⁾	Temperature class
-60 °C to +80 °C	-60 °C to +80 °C	T6
-60 °C to +95 °C	-60 °C to +80 °C	T5
-60 °C to +130 °C	-60 °C to +80 °C	T4
-60 °C to +195 °C	-60 °C to +80 °C	T3
-60 °C to +290 °C	-60 °C to +80 °C	T2
-60 °C to +440 °C	-60 °C to +80 °C	T1

(1) *Min. process temperature and min. ambient temperature is limited to -50 °C for models with enclosure designation “AD1” or “SD1”.*

6.7 Korea

6.7.1 EP Korea Flameproof

Certificate 22-KA4BO-0073X

Markings Ex db IIC T6...T1 Gb, T6 (-60 °C ≤ T_a ≤ +70 °C), T5...T1 (-60 °C ≤ T_a ≤ +80 °C),

Special Condition for Safe Use (X):

Refer to certificate for Special Conditions for Safe Use.

6.7.2 IP Korea Intrinsic Safety

Certificate 17-KA4BO-0304X

Markings Ex ia IIC T6/T5

Special Condition for Safe Use (X):

Refer to certificate for details regarding process and ambient temperature limits as well as Special Conditions for Safe Use.

6.7.3 KP Korea Flameproof, Dust Ignitionproof, and Intrinsic Safety

Certificate 22-KA4BO-0074X in addition to the EP and IP certificate numbers

Markings Ex tb IIIC T130 °C Db, ($-60\text{ °C} \leq T_a \leq +80\text{ °C}$) in addition to the markings for EP and IP

Special Condition for Safe Use (X):

Refer to certificate for details regarding process and ambient temperature limits as well as Special Conditions for Safe Use.

6.8 Russia

6.8.1 EM Technical Regulation Customs Union TR CU 012/2011 (EAC) Flameproof

Markings 1Ex db IIC T6...T1 Gb X, T6 ($-55\text{ °C} \leq T_a \leq +80\text{ °C}$), T5 ($-55\text{ °C} \leq T_a \leq +95\text{ °C}$), T4...T1 ($-55\text{ °C} \leq T_a \leq +100\text{ °C}$)

Special Condition for Safe Use (X):

Refer to certificate for Special Conditions for Safe Use.

6.8.2 IM Technical Regulation Customs Union TR CU 012/2011 (EAC) Intrinsic Safety

Markings 0Ex ia IIC T5, T6 Ga X

Special Condition for Safe Use (X):

Refer to certificate for details regarding process and ambient temperature limits as well as Special Conditions for Safe Use.

6.8.3 KM Technical Regulation Customs Union TR CU 012/2011 (EAC) Flameproof, Dust-Ignitionproof, and Intrinsic Safety

Markings Ex tb IIIC T130 °C Db X in addition to the markings above for EM and IM.

Special Condition for Safe Use (X):

Refer to certificate for details regarding process and ambient temperature limits as well as Special Conditions for Safe Use.



6.9 Combinations



- K1** Combination of E1, I1, N1, and ND
- K3** Combination of E3 and I3
- K7** Combination of E7, I7, N7, and NK
- KA** Combination of E1 and E6
- KB** Combination of E5 and E6
- KC** Combination of E1 and E5
- KD** Combination of E1, E5, and E6
- KE** Combination of E1, E5, E6, and E7
- KM** Combination of EM and IM

KN Combination of N1, N5, N6, and N7

KP Combination of EP and IP

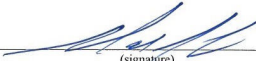
7 Declaration of Conformity

	<h2 style="margin: 0;">EU Declaration of Conformity</h2> <p style="margin: 0;">No: RMD 1109 Rev. G</p>	
<p>We,</p> <p style="margin-left: 40px;">Rosemount, Inc. 6021 Innovation Boulevard Shakopee, MN 55379-4676 USA</p> <p>declare under our sole responsibility that the product,</p> <p style="margin-left: 40px;">Rosemount™ 65, 85, 185, and 214C Temperature Sensors</p> <p>manufactured by,</p> <p style="margin-left: 40px;">Rosemount, Inc. 6021 Innovation Boulevard Shakopee, MN 55379-4676 USA</p> <p>to which this declaration relates, is in conformity with the provisions of the European Union Directives, including the latest amendments, as shown in the attached schedule.</p> <p>Assumption of conformity is based on the application of the harmonized standards and, when applicable or required, a European Union notified body certification, as shown in the attached schedule.</p>		
<div style="display: flex; justify-content: space-between; align-items: flex-end;"> <div style="width: 45%;">  <p style="text-align: center; margin-top: 5px;">(signature)</p> </div> <div style="width: 45%;"> <p style="text-align: center;">Vice President of Global Quality</p> <p style="text-align: center; margin-top: 5px;">(function)</p> </div> </div> <div style="display: flex; justify-content: space-between; align-items: flex-end; margin-top: 20px;"> <div style="width: 45%;"> <p style="text-align: center;">Mark Lee</p> <p style="text-align: center; margin-top: 5px;">(name)</p> </div> <div style="width: 45%;"> <p style="text-align: center;"><i>October 22, 2021</i></p> <p style="text-align: center; margin-top: 5px;">(date of issue)</p> </div> </div>		
<p>Page 1 of 2</p>		

	EU Declaration of Conformity No: RMD 1109 Rev. G	
ATEX Directive (2014/34/EU)		
DEKRA 19ATEX0076 X - Flameproof Certificate Equipment Group II Category 2 G (Ex db IIC T6...T1 Gb) Harmonized Standards: EN IEC 60079-0:2018, EN 60079-1:2014		
DEKRA 19ATEX0076 X - Dust Certificate Equipment Group II Category 2 D (Ex tb IIIC T130°C Db) Harmonized Standards: EN IEC 60079-0:2018, EN 60079-31:2014		
BAS00ATEX3145 - Type n Certificate Equipment Group II Category 3 G (Ex nA IIC T5 Ge) Harmonized Standards: EN 60079-0:2012+A11:2013 (a review against EN IEC 60079-0:2018, which is harmonized, shows no significant changes relevant to this equipment so EN 60079-0:2012+A11:2013 continues to represent "State of the Art"), EN 60079-15:2010		
Baseefa16ATEX0101X – Intrinsic Safety Certificate Equipment Group II Category 1 G (Ex ia IIC T5/T6 Ga) Harmonized Standards: EN IEC 60079-0:2018, EN 60079-11:2012		
<hr/>		
RoHS Directive (2011/65/EU) Harmonized Standard: EN 50581:2012		
<hr/>		
ATEX Notified Bodies for EC Type Examination Certificate		
Dekra Certification B.V. [Notified Body Number: 0344] Utrechtseweg 310 Postbus 5185 6802 ED Arnhem Netherlands		
SGS FIMKO OY [Notified Body Number: 0598] Takomotie 8 00380 HELSINKI Finland		
ATEX Notified Body for Quality Assurance		
SGS FIMKO OY [Notified Body Number: 0598] Takomotie 8 00380 HELSINKI Finland		
<hr/>		
Page 2 of 2		

8 China RoHS

斯蒙特品型号 214C
2/9/2021

含有China RoHS 管控物质超过最大浓度限值的部件型号列表 214C Temperature Sensor
List of 214C Temperature Sensor Parts with China RoHS Concentration above MCVs

部件名称 Part Name	有害物质 / Hazardous Substances					
	铅 Lead (Pb)	汞 Mercury (Hg)	镉 Cadmium (Cd)	六价铬 Hexavalent Chromium (Cr +6)	多溴联苯 Polybrominated biphenyls (PBB)	多溴联苯醚 Polybrominated diphenyl ethers (PBDE)
壳体组件 Housing Assembly	○	○	○	○	○	○
传感器组件 Sensor Assembly	○	○	○	○	○	○

本表格系依据SJ/T11364的规定而制作。

This table is proposed in accordance with the provision of SJ/T11364.

○: 意为该部件的所有均质材料中该有害物质的含量均低于GB/T 26572所规定的限量要求。

○: Indicate that said hazardous substance in all of the homogeneous materials for this part is below the limit requirement of GB/T 26572.

X: 意为在该部件所使用的的所有均质材料里，至少有一类均质材料中该有害物质的含量高于GB/T 26572所规定的限量要求。

X: Indicate that said hazardous substance contained in at least one of the homogeneous materials used for this part is above the limit requirement of GB/T 26572.

部件名称 Part Name	组装备件说明 Spare Parts Descriptions for Assemblies
壳体组件 Housing Assembly	电子外壳 Electrical Housing



Quick Start Guide
00825-0400-2654, Rev. DE
July 2023

For more information: [Emerson.com](https://www.emerson.com)

©2023 Emerson. All rights reserved.

Emerson Terms and Conditions of Sale are available upon request. The Emerson logo is a trademark and service mark of Emerson Electric Co. Rosemount is a mark of one of the Emerson family of companies. All other marks are the property of their respective owners.

ROSEMOUNT™

