

Rosemount™ 2535 Solids Level Switches

Vibrating Rod



Contents

Introduction..... 3

Mechanical installation.....8

Electrical installation..... 13

Configuration..... 19

Operation.....21

Maintenance..... 22

1 Introduction

The level switch detects the presence and absence of a process media at its installation point, and reports it as a switched electrical output.

Note

Other language versions of this Quick Start Guide can be found at [Emerson.com/Rosemount](https://emerson.com/Rosemount).

1.1 Safety messages

NOTICE

Read this manual before working with the product. For personal and system safety, and for optimum product performance, ensure you thoroughly understand the contents before installing, using, or maintaining this product.

For technical assistance, contacts are listed below:

Customer Central

Technical support, quoting, and order-related questions.

- United States - 1-800-999-9307 (7:00 am to 7:00 pm CST)
- Asia Pacific- 65 777 8211

North American Response Center

Equipment service needs.

- 1-800-654-7768 (24 hours a day — includes Canada)
- Outside of these areas, contact your local Emerson representative.

⚠ WARNING

Physical access

Unauthorized personnel may potentially cause significant damage to and/or misconfiguration of end users' equipment. This could be intentional or unintentional and needs to be protected against.

Physical security is an important part of any security program and fundamental to protecting your system. Restrict physical access by unauthorized personnel to protect end users' assets. This is true for all systems used within the facility.

⚠ WARNING

Failure to follow safe installation and servicing guidelines could result in death or serious injury.

- Ensure the level switch is installed by qualified personnel and in accordance with applicable code of practice.
- Use the level switch only as specified in this manual. Failure to do so may impair the protection provided by the level switch.

Explosions could result in death or serious injury.

- In explosion-proof/flameproof, increased-safety, and dust ignition-proof installations, do not remove the housing cover when power is applied to the level switch.
- The housing cover must be fully engaged to meet flameproof/explosion-proof requirements.

Electrical shock could cause death or serious injury.

- Avoid contact with the leads and terminals. High voltage that may be present on leads can cause electrical shock.
- Ensure the power to the level switch is off, and the lines to any other external power source are disconnected or not powered while wiring the level switch.
- Ensure the wiring is suitable for the electrical current and the insulation is suitable for the voltage, temperature, and environment.

Process leaks could result in death or serious injury.

- Ensure the level switch is handled carefully. If the process seal is damaged, gas or dust might escape from the silo (or other vessel)

Any substitution of non-recognized parts may jeopardize safety. Repair (e.g. substitution of components) may also jeopardize safety and is not allowed under any circumstances.

- Unauthorized changes to the product are strictly prohibited as they may unintentionally and unpredictably alter performance and jeopardize safety. Unauthorized changes that interfere with the integrity of the welds or flanges, such as making additional perforations, compromise product integrity and safety. Equipment ratings and certifications are no longer valid on any products that have been damaged or modified without the prior written permission of Emerson. Any continued use of product that has been damaged or modified without the written authorization is at the customer's sole risk and expense.

⚠ CAUTION

The products described in this document are NOT designed for nuclear-qualified applications.

- Using non-nuclear qualified products in applications that require nuclear-qualified hardware or products may cause inaccurate readings.
- For information on Rosemount nuclear-qualified products, contact your local Emerson Sales Representative.

Individuals who handle products exposed to a hazardous substance can avoid injury if they are informed of and understand the hazard.

- If the product being returned was exposed to a hazardous substance as defined by Occupational Safety and Health Administration (OSHA), a copy of the required Safety Data Sheet (SDS) for each hazardous substance identified must be included with the returned level switch.

1.2 Applications

A Rosemount™ 2535 Solids Level Switch is used for monitoring the level of bulk materials in all types of containers and silos.

The level switch can be used with all powdery and granulated bulk materials that have a density greater than 20 g/l (1.25 lb/ft³) and that do not show a strong tendency to form crusts or deposits.

Typical applications are:

- Building materials
 - Lime, extruded polystyrene foam (XPS), molding sand, etc.
- Food and beverage
 - Milk powder, flour, salt, etc.
- Plastics
 - Plastic granulates, etc.
- Timber
- Chemicals

The level switch has a threaded, flanged, or Tri Clamp process connection for mounting it onto a silo (or other vessel). You can mount it on a side wall of the silo, so that it is level with the filling limit to be monitored. Alternatively, if it has an extended length, mount it vertically on top of a silo to monitor the maximum filling limit.

The length of the rod can be up to 157.5 in. (4 m) with an extension tube.

The use of a sliding sleeve is recommended so that the switching point can be changed easily during the live operation of the level switch.

Figure 1-1: Typical Installation Examples

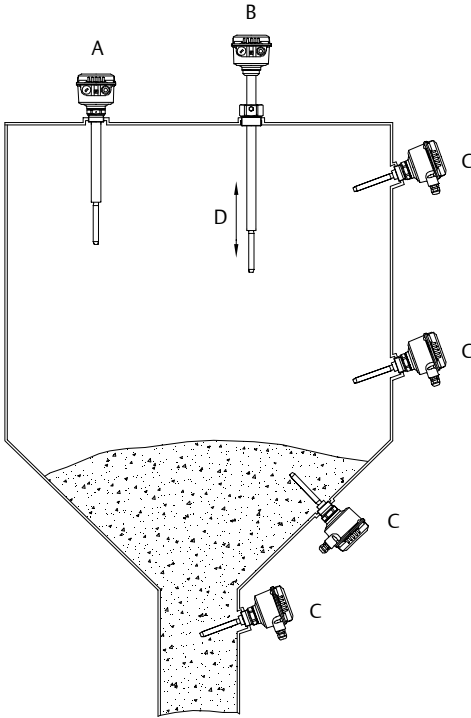

- A. Rosemount 2535 with the tube-extended rod length
- B. Rosemount 2535 with the tube-extended rod length and thermal tube-extension
- C. Rosemount 2535 with the standard length rod
- D. Optional sliding sleeve

1.3 Measurement principles

Using the principle of a tuning fork, a piezo-electric crystal oscillates the rod at its natural frequency. Changes to the oscillation frequency are continuously monitored by the electronics which varies depending on whether the rod is covered or uncovered.

When the solids medium in the vessel (silo) falls away from the rod, it causes a change of oscillation frequency that is detected by the electronics and the output switches to indicate an 'uncovered' state.

When the solids medium in the vessel (silo) rises and covers the rod, it causes a change of oscillation frequency that is detected by the electronics and the output switches to indicate a 'covered' state.

The electrical output will vary depending on the electronics selected when the Rosemount 2535 was ordered.

2 Mechanical installation

2.1 Mounting considerations

Before mounting the level switch on a silo (or other vessel), review the safety and pre-mounting sections.

2.1.1 Safety

General safety

1. Installation of this equipment shall be carried out by suitably trained personnel, in accordance with the applicable code of practice.
2. If equipment is likely to come into contact with aggressive substances, it is the user's responsibility to take suitable precautions that prevent it from being adversely affected, thus ensuring the type of protection is not compromised.
 - a. **Aggressive substances:** Acidic liquids or gases that may attack metals or solvents that may affect polymeric materials.
 - b. **Suitable precautions:** Regular checks as part of routine inspections or establishing from a material's data sheet that it is resistant to specific chemicals.
3. It is the responsibility of the installer to:
 - a. Take protective measures, such as fitting an angled shield (reverse V shape) to the silo or selecting an extension tube option, when there are high mechanical forces.
 - b. Ensure that the process connection is tightened by the correct amount of torque and sealed to prevent process leaks.
4. Technical data
 - a. The Rosemount 2535 [Product Data Sheet](#) has all the technical specifications. See [Emerson.com/Rosemount](#) for other language versions.

Hazardous area safety

The Rosemount 2535 [Product Certifications document](#) has safety instructions and control drawings for hazardous area installations. See [Emerson.com/Rosemount](#) for other language versions.

2.1.2 Mechanical load

The load at the mounting point must not exceed 180 Nm (Rosemount 2535 with an extended length fork).

Figure 2-1: Mechanical Load

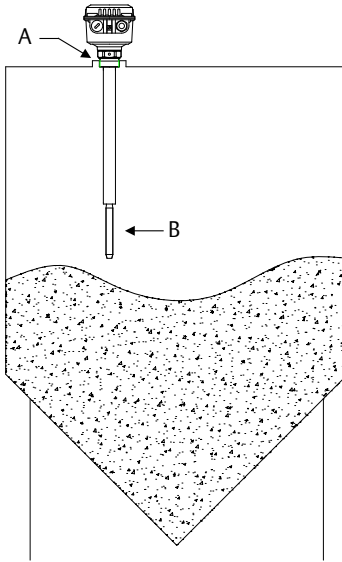

- A. Mounting point
- B. Mechanical load

2.1.3 Vertical installations

Table 2-1 provides the maximum fork lengths and the corresponding maximum deviations from a normal vertical installation.

Table 2-1: Maximum Vertical Deviation

Maximum deviation	Maximum fork length
5°	157.5 in. (4000 mm)
45°	47.24 in. (1200 mm)
> 45°	23.62 in. (600 mm)

2.1.4 Mounting location

Take time to assess a suitable mounting location. Avoid mounting the level switch near the filling point, internal structures, and walls of a silo (or other vessel). When mounting the extended length versions of the level switch, it is especially important to consider internal structures. Forcing the level switch into a small or congested space risks damage to the sensor and could impair the protection it provides.

2.1.5 Sliding sleeve

Tighten both M8 screws with a torque of 20 Nm to establish a seal and maintain the process pressure. See [Figure 2-2](#).

Figure 2-2: Sliding Sleeve, M8 Screws

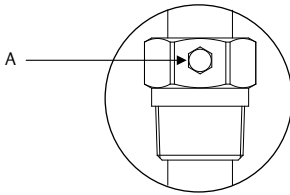

A. Two off M8 screws

2.1.6 Flange mounting

A suitable gasket must be fitted to provide a seal when the flanges are tightened.

2.1.7 Tightening threaded process connections

When tightening the threaded process connection of a Rosemount 2535:

- Use an open-ended wrench on the hexagonal boss of the level switch or the sliding sleeve.
- Never tighten by using the housing.
- Do not exceed the maximum torque of 80 Nm.

2.1.8 Hygienic applications

The food-grade materials are suitable for use under normal and predictable hygienic applications (according to directive 1935/2004 Art.3). There are currently no hygienic certifications for the Rosemount 2535.

2.1.9 Vibrating rod

Bending, shortening, or extending the rod will damage the level switch.

2.1.10 Orientation of cable glands

When the level switch is mounted horizontally, ensure the cable glands are pointed downwards to avoid water getting inside the housing. Unused conduit entries must be completely sealed with a suitably rated stopping (blanking) plug.

2.1.11 Seals

Apply PTFE tape to the threaded process connection. This is required for a silo (or other vessel) to maintain the process pressure.

2.1.12 Future maintenance

It is advisable to grease the screws of the housing cover (lid) when a corrosive atmosphere is present. This will help prevent difficulties when the cover needs to be removed during future maintenance tasks.

2.1.13 Switching point

Heavy bulk materials

The signal output switches over when the vibrating rod of the level switch are covered a few millimeters.

Light bulk materials

The signal output switches over when the vibrating rod of the level switch are covered a few centimeters.

2.2 Mounting the level switch

Figure 2-3 shows how the level switch should be mounted.

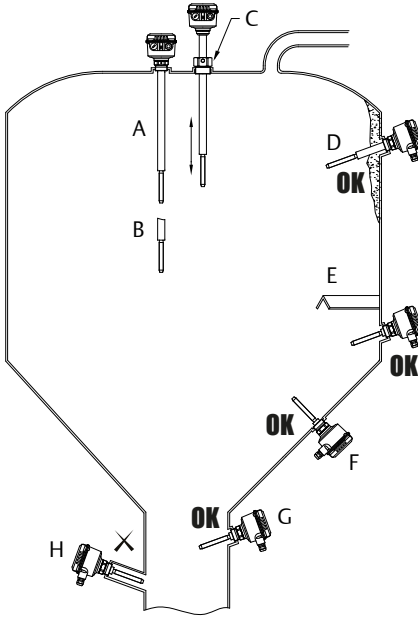
Figure 2-3: Correct and Incorrect Mounting

- A. Full-silo detection using extended length rod option
- B. Empty-silo detection using extended length rod option
- C. Sliding sleeve option
- D. Bulk solids slide downwards more easily when the device is mounted at an angle (recommended)
- E. Steel protection shield
- F. Correct installation - the vibrating rod is angled upwards to lead into the solids material
- G. Correct installation - the vibrating rod is angled downwards
- H. Incorrect installation - the socket is too long and allows the solids material to easily accumulate inside it

3 Electrical installation

3.1 Safety messages

⚠ WARNING

Failure to follow safe installation and servicing guidelines could result in death or serious injury.

- Ensure the level switch is installed by qualified personnel and in accordance with applicable code of practice.
- Use the level switch only as specified in this manual. Failure to do so may impair the protection provided by the level switch.

Explosions could result in death or serious injury.

- In explosion-proof/flameproof, increased-safety, and dust ignition-proof installations, do not remove the housing cover when power is applied to the level switch.
- The housing cover must be fully engaged to meet flameproof/explosion-proof requirements.

Electrical shock could cause death or serious injury.

- Avoid contact with the leads and terminals. High voltage that may be present on leads can cause electrical shock.
- Ensure the power to the level switch is off, and the lines to any other external power source are disconnected or not powered while wiring the level switch.
- Ensure the wiring is suitable for the electrical current and the insulation is suitable for the voltage, temperature, and environment.

3.2 Wiring considerations

Note

See the Rosemount 2535 [Product Data Sheet](#) for the full electrical specifications.

3.2.1 Handling

In cases of improper handling or handling malpractice, the electrical safety of the device cannot be guaranteed.

3.2.2 Protective earthing

Before any electrical installation, the device must be connected to the protective earthing terminal inside the housing.

3.2.3 Installation regulations

Local regulations or VDE 0100 (Regulations of German Electrotechnical Engineers) must be observed.

When using 24 V supply voltage, an approved power supply with reinforced insulation to mains is required.

3.2.4 Fuse

Use a fuse as stated in the connection diagrams.

For details, see [Wiring the level switch](#).

3.2.5 Residual Current Circuit Breaker (RCCB) protection

In case of a defect, the distribution voltage must automatically be cut-off by an RCCB protection switch to protect against indirect contact with dangerous voltages.

3.2.6 Power supply

Power supply switch

A voltage disconnection switch must be provided near the device.

Supply voltage

Compare the supply voltage applied with the specifications given on the electronic module and nameplate before switching on the device.

3.2.7 Wiring

Field wiring cables

The diameter has to match the clamping range of the used cable gland.

The cross-section has to match the clamping range of the connection terminals and the maximum current must be considered.

All field wiring must have insulation suitable for at least 250 Vac.

The temperature rating must be at least 194 °F (90 °C).

Use a shielded cable when there are electrical interferences present that are higher than stated in the EMC standards. Otherwise, an unshielded instrumentation cable can be used.

Guiding the cables in the terminal box

The field wiring cables must be cut to a length to be able to properly fit them into the terminal box.

Wiring diagram

The electrical connections are made in accordance with the wiring diagram.

3.2.8 Cable glands

The screwed cable gland and stopping plug must have the following specifications:

- Ingress protection IP67
- Temperature range from -40 °C to +70 °C
- Hazardous area certification (depending on where the unit is installed)
- Pull relief

Ensure the screwed cable gland safely seals the cable and is tight enough to prevent water ingress. Unused conduit or cable entries must be sealed with a stopping (blanking) plug.

A strain relief must be provided for the field wiring cables when the device is installed with the factory-provided cable glands.

Cable glands and conduit system for ATEX or IECEx

The installation must comply with the regulations of the country where the level switch is installed.

Unused entries have to be closed with suitably rated stopping (blanking) plugs.

Where available, the factory-provided parts must be used.

The diameter of the field wiring cable must match the clamping range of the cable clamp.

If factory-provided parts are not used, the following must be ensured:

- The parts must have an approval adequate to the approval of the level sensor (certificate and type of protection).
- The approved temperature range must be between the minimum ambient temperature of the level sensor and the maximum ambient temperature of the level sensor increased by 10 K.
- The parts must be mounted according to the instructions of the manufacturer.

3.2.9 Conduit system

When a threaded conduit system is used instead of a cable gland, the regulations of the country must be observed. The conduit must have a ½-in. NPT tapered thread to match a NPT threaded conduit entry of the level switch and comply with ANSI B 1.20.1. Unused conduit entries must be closed tightly with a metal stopping (blanking) plug.

Conduit system for FM

The regulations of the country must be observed. The flameproof seals and stopping (blanking) plugs must have an adequate type approval and a temperature range of at least -40 to 176 °F (-40 to +80 °C). In addition, they must be suitable for the conditions and correctly installed. Where available, the original provided parts of the manufacturer must be used.

3.2.10 Connection terminals

When preparing cable wires for connection to terminals, the wire insulation must be stripped to show no more than 0.31 in. (8 mm) of the copper strands. Always check that the power supply is disconnected or switched-off to avoid coming into contact with dangerous live parts.

3.2.11 Relay and transistor protection

Provide protection for relay contacts and output transistors to protect the device against inductive load surges.

3.2.12 Static charging

The Rosemount 2535 must be grounded to avoid a static electrical build-up. This is particularly important for applications with pneumatic conveying and non-metallic containers.

3.2.13 External equipotential bonding terminal

Connect with equipotential bonding of the plant.

Figure 3-1: External Equipotential Bonding Terminal

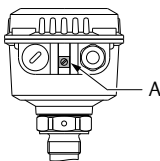

A. Equipotential bonding terminal on the Rosemount 2535

3.2.14 Commissioning

Commissioning must be performed with closed lid.

3.2.15 Opening the lid

Before opening the lid, ensure no dust deposits, no airborne dusts, and no hazardous atmosphere are present.

Do not remove the lid (cover) in hazardous areas while circuits are alive.

3.3 Wiring the level switch

Figure 3-2: PCB Connections

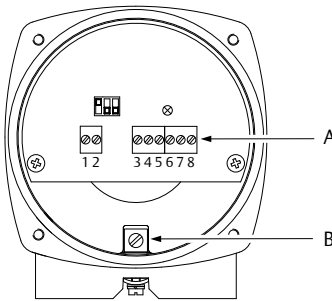

- A. Connection terminals
B. Protective conductor terminal

Wiring the universal voltage DPDT relay

Power supply:

- 21 to 230 Vac (50/60 Hz $\pm 10\%$ ⁽¹⁾, 22 VA
- 22 to 45 Vdc $\pm 10\%$ ⁽¹⁾, 2 W
- Fuse on power supply: maximum 10 A, fast or slow, HBC, 250 V

Signal output:

- Maximum 250 Vac, 8 A, non-inductive
- Maximum 30 Vac, 5 A, non-inductive
- Fuse on signal output: maximum 10 A, fast or slow, HBC, 250 V

(1) including $\pm 10\%$ of EN 61010

Figure 3-3: Power Supply and Signal Output (Universal Voltage Version)

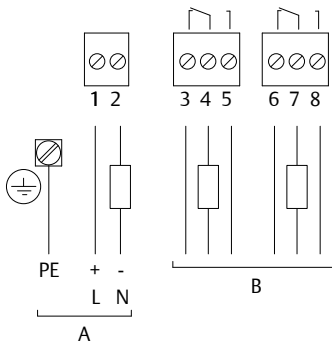

- A. Power supply
- B. Signal output

Wiring the 3-wire PNP

Power supply:

- 20 to 40 Vdc $\pm 10\%$ ⁽¹⁾
- Input current: maximum 0.5 A
- Fuse: maximum 4 A, fast or slow, 250 V

Signal output:

- Maximum 0.4 A
- Output voltage equal to input voltage, drop <2.5 V
- Load for example: PLC, relay, and bulb

Figure 3-4: Power Supply and Signal Output (Three-wire PNP)

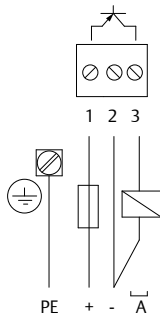

- A. Load

4 Configuration

4.1 Adjustment of the signal output

FSH setting

If the sensor is used to indicate full load, set to **Fail Safe High**. Power failure or line break is regarded as full signal (protection against overcharging).

FSL setting

If the sensor is used to indicate empty load, set to **Fail Safe Low**. Power failure or line break is regarded as empty signal (protection against running dry).

Figure 4-1: FSL and FSH Settings

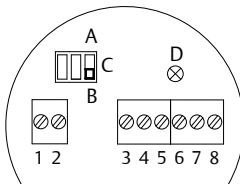

- A. FSL
- B. FSH
- C. FSL/FSH setting
- D. LED signal output

4.2 Sensitivity settings

All sensors are factory-set to position III to cover the majority of applications. If the bulk material is heavy and has a strong tendency to cake or deposit, the setting can be set to position IV to decrease the sensitivity of the probe.

If the bulk material is light and has few or no tendency to cake or deposit, the setting can be set to position II or I to increase the sensitivity of the probe.

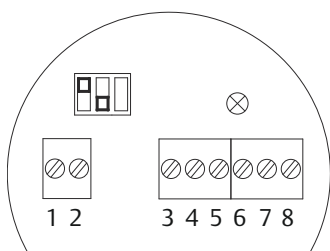
Figure 4-2: Sensitivity Settings**Table 4-1: The Approximate Minimum Bulk Density Depending on the Position**

Position	Sensitivity/Powder density (ca.)	
I	High >20 g/l (1.25 lb/ft ³)	
II	Medium high >80 g/l (5 lb/ft ³)	
III ⁽¹⁾	Medium low >150 g/l (9.4 lb/ft ³)	
IV	Low >300 g/l (18.7 lb/ft ³)	

(1) Factory preset

5 Operation

5.1 Signal output (switching logic)

Figure 5-1: Switching Logic (All Versions)

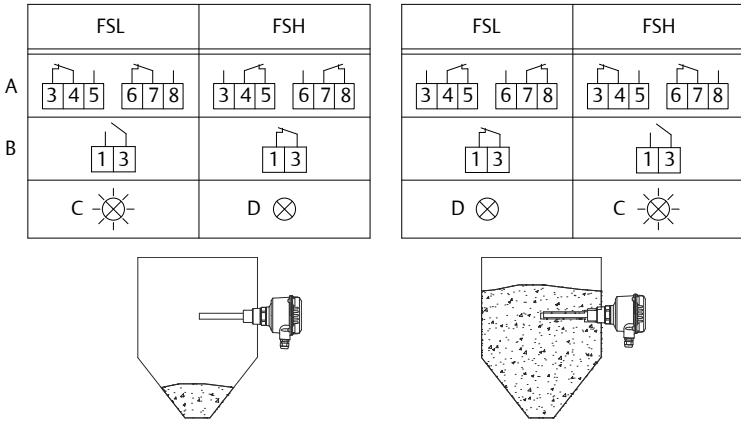

- A. Relay DTPT
- B. 3-wire PNP
- C. LED is flashing
- D. LED is constantly on

Note

See [Adjustment of the signal output](#) for how to select a FSH or FSL setting.

6 Maintenance

6.1 Opening the lid (cover)

Before opening the lid for maintenance reasons, consider the following:

- Do not remove the lid in a hazardous area while circuits are live.
- Ensure that no dust deposits or airborne dusts are present.
- Ensure that rain does not enter the housing.

6.2 Regular checks for safety

To ensure robust safety in hazardous locations and with electrical safety, the following items must be regularly checked depending on the application:

- Mechanical damage or corrosion of the field wiring cables or any other components (housing side and sensor side).
- Tight sealing of the process connection, cable glands, and enclosure lid.
- Properly connected external PE cable (if present).

6.3 Cleaning

If cleaning is required by the application, the cleaning agent must comply with the materials of the unit (chemical resistance). Mainly the shaft sealing, lid sealing, cable gland, and the surface of the unit must be considered.

During the cleaning process, consider the following:

- The cleaning agent cannot enter the unit through the shaft sealing, lid sealing, or cable gland.
- No mechanical damage of the shaft sealing, lid sealing, cable gland, or other parts can occur.

A possible accumulation of dust on the unit does not increase the maximum surface temperature and must therefore not be removed for purposes of maintaining the surface temperature in hazardous locations.

6.4 Function test

A frequent function test may be required depending on the application.

Observe all relevant safety precautions related to work safety (e.g. electrical safety, process pressure, etc).

This test does not prove if the level switch is sensitive enough to measure the material of the application.

Function tests are done by covering the rod with a suitable solids material and monitoring if a correct change of the signal output from uncovered to covered happens.

6.5 Production date

The production year is shown on the nameplate.

6.6 Spare parts

Refer to the Rosemount 2535 [Product Data Sheet](#) for all spare parts.



Emerson Automation Solutions

6021 Innovation Blvd.
Shakopee, MN 55379, USA

 +1 800 999 9307 or +1 952 906 8888

 +1 952 949 7001

 RFQ.RMD-RCC@Emerson.com

Latin America Regional Office

Emerson Automation Solutions
1300 Concord Terrace, Suite 400
Sunrise, FL 33323, USA

 +1 954 846 5030

 +1 954 846 5121

 RFQ.RMD-RCC@Emerson.com

Asia Pacific Regional Office

Emerson Automation Solutions
1 Pandan Crescent
Singapore 128461

 +65 6777 8211

 +65 6777 0947

 Enquiries@AP.Emerson.com

 [Linkedin.com/company/Emerson-Automation-Solutions](https://www.linkedin.com/company/Emerson-Automation-Solutions)

 [Twitter.com/Rosemount_News](https://twitter.com/Rosemount_News)

 [Facebook.com/Rosemount](https://www.facebook.com/Rosemount)

 [Youtube.com/user/RosemountMeasurement](https://www.youtube.com/user/RosemountMeasurement)

North America Regional Office

Emerson Automation Solutions
8200 Market Blvd.

Chanhassen, MN 55317, USA

 +1 800 999 9307 or +1 952 906 8888

 +1 952 949 7001

 RMT-NA.RCCRFQ@Emerson.com

Europe Regional Office

Emerson Automation Solutions Europe
GmbH

Neuhofstrasse 19a P.O. Box 1046

CH 6340 Baar

Switzerland

 +41 (0) 41 768 6111

 +41 (0) 41 768 6300

 RFQ.RMD-RCC@Emerson.com

Middle East and Africa Regional Office

Emerson Automation Solutions

Emerson FZE P.O. Box 17033

Jebel Ali Free Zone - South 2

Dubai, United Arab Emirates

 +971 4 8118100

 +971 4 8865465

 RFQ.RMTMEA@Emerson.com

©2020 Emerson. All rights reserved.

Emerson Terms and Conditions of Sale are available upon request. The Emerson logo is a trademark and service mark of Emerson Electric Co. Rosemount is a mark of one of the Emerson family of companies. All other marks are the property of their respective owners.