

Micro Motion[®] R-Series Coriolis Flow and Density Meters



Detailed Specifications

R-Series accuracy

Model	Liquid mass flow accuracy		Gas mass flow accuracy	Density accuracy (g/cm ³)	
	0.50%	0.40%	0.75%	0.01	0.003
R025	•	•	•	•	•
R050	•	•	•	•	•
R100	•	•	•	•	•
R200	•	•	•	•	•
R300	•	•	•	•	•

Flow tube information

Model	Number of tubes	Tube inside diameter inches	Tube inside diameter mm	Tube length inches	Tube length mm
R025	2	0.21	5.3	14.6	370
R050	2	0.35	8.8	18.8	478
R100	2	0.65	16	25.1	637
R200	2	1.1	27	23.5	598
R300	2	1.6	40	34.4	874

ASME B16.5 specification flange compatibility

Model	1/2"	3/4"	1"	1-1/2"	2"	3"	4"
R025	•	•	•				
R050	•	•	•				
R100			•	•	•		
R200				•	•	•	
R300						•	•

DIN specification flange compatibility

Model	DN15	DN25	DN40	DN50	DN80	DN100
R025	•					
R050	•	•				
R100		•				
R200			•	•		
R300					•	•

EN1092-1 specification flange compatibility

Model	DN15	DN25	DN40	DN50	DN80	DN100
R025	•	•				
R050	•	•				
R100		•				
R200			•	•		
R300					•	•

JIS B 2220 specification flange compatibility

Note







Sensors with JIS process connections do not meet ASME B31.1 power piping code.

Model	15mm	25mm	40mm	50mm	80mm	100mm
R025	•					
R050	•					
R100		•				
R200			•	•		
R300					•	•

VCO/VCR specification flange compatibility and Tri-Clamp® compatible flanges

Model	VCO specification				Tri-clamp compatible					
	#4	#8	#12	#16	1/2"	3/4"	1"	1-1/2"	2"	3"
R025		•	•		•	•				
R050		•	•		•	•				
R100				•			•			
R200								•	•	
R300										•

Transmitter compatibility

Sensor model	Transmitter model						
	1500/2500	1700/2700	2400S	3000 Series	FMT	4200	5700 Series
							
All R-Series models	•	•	•	•	Only the R025, R050, R100	•	•

Process pressure ratings

Sensor maximum working pressure reflects the highest possible pressure rating for a given sensor. Process connection type and environmental and process fluid temperatures may reduce the maximum rating. Refer to the Technical Data Sheet for common sensor and fitting combinations.

All sensors comply with Council Directive 2014/68/EU on pressure equipment.

Note

R-Series sensors with JIS process connections do not comply with ASME B31.1 power piping code.

Sensor maximum working pressure for all models: 316L stainless steel (S) and high pressure (P)

Model	Pressure
All stainless steel models (R025S–R300S)	1,450 psig (100 barg)
R025P	2,300 psig (159 barg)

Temperature and pressure de-ratings

Note

- The ratings in this section apply to the combined sensor and process connection to ensure that the meter does not exceed the limits of either component.
- The temperature and pressure de-ratings graphs do not represent all possible model and fitting combinations. For combinations not listed here, contact a sales representative or the factory.

ASME B16.5 (CL150-CL600)

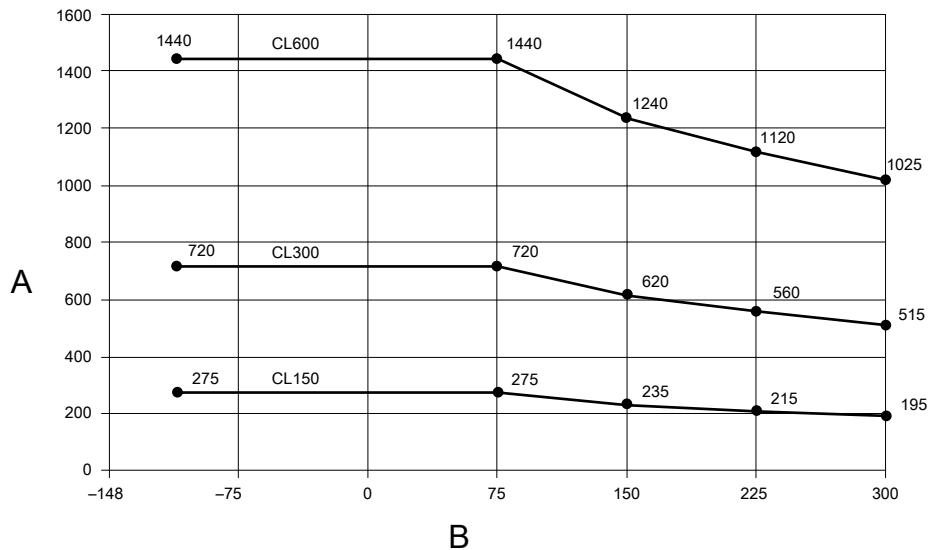

A. Pressure (psi)
 B. Temperature (°F)

ASME B16.5 (CL900-CL2500)

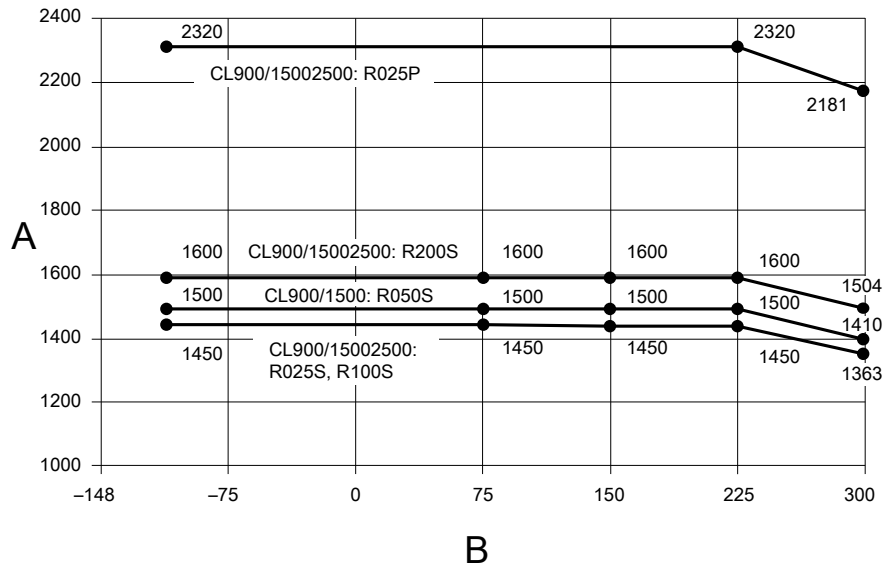

A. Pressure (psi)
 B. Temperature (° F)

DIN 2635 & 11851 F316/F316L

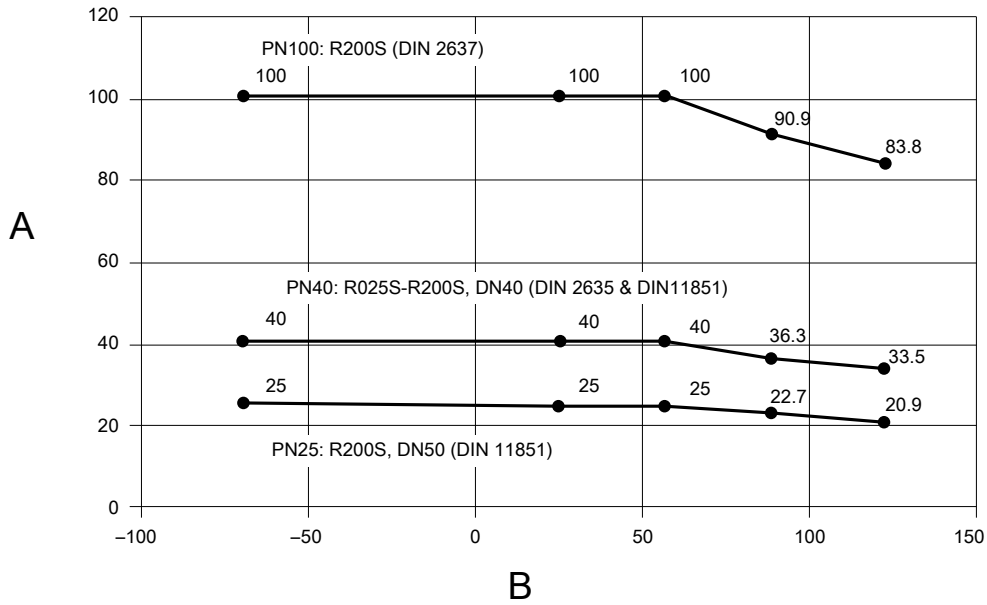

A. Pressure (Bar)
 B. Temperature (° C)

DIN 2638 F316/F316L

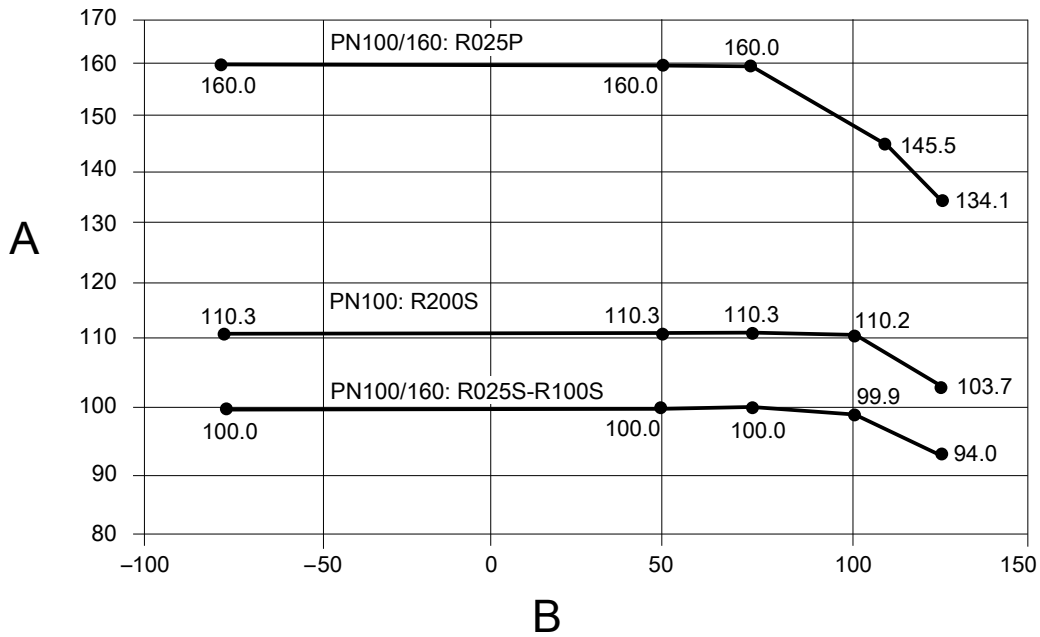

A. Pressure (Bar)
 B. Temperature (°C)

EN 1092-1 F316/F316L

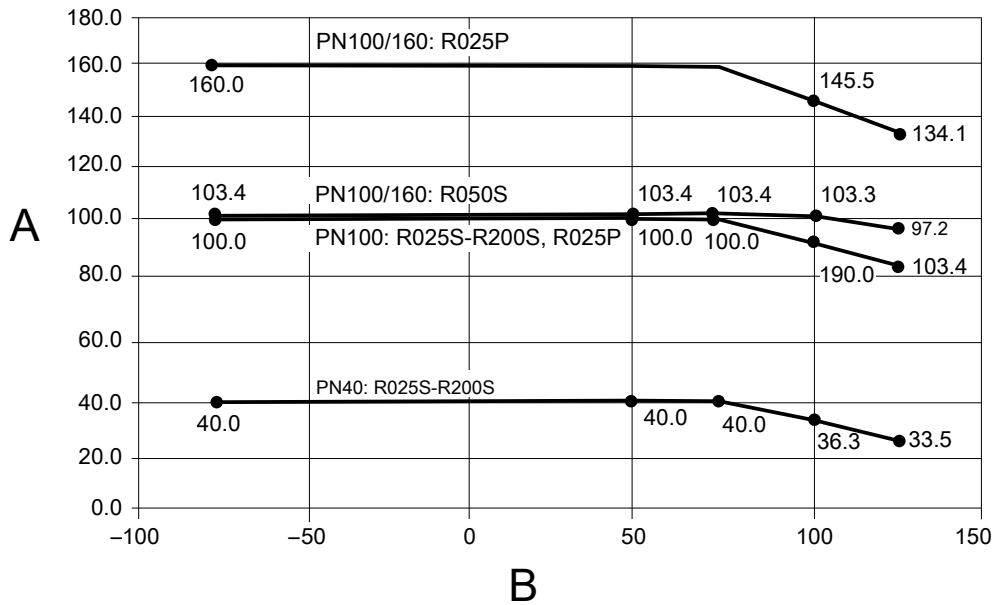

A. Pressure (Bar)
 B. Temperature (°C)

JIS B 2220 F316/F316L

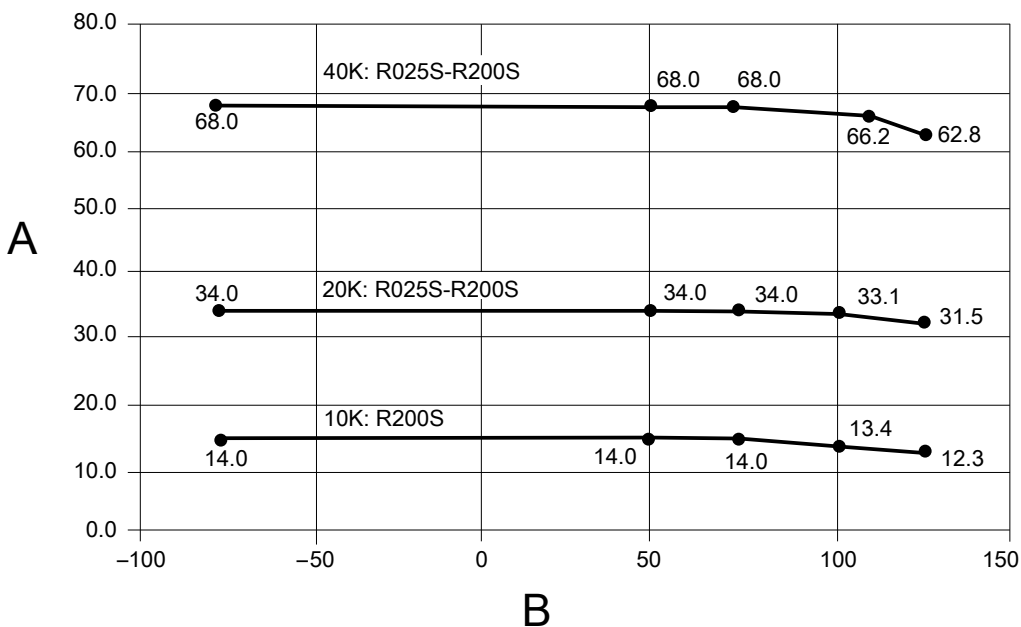

A. Pressure (Bar)
 B. Temperature (° C)

Note

Sensors with JIS process connections do not comply with ASME B31.1 power piping code.

Tri-Clamp compatible 316L

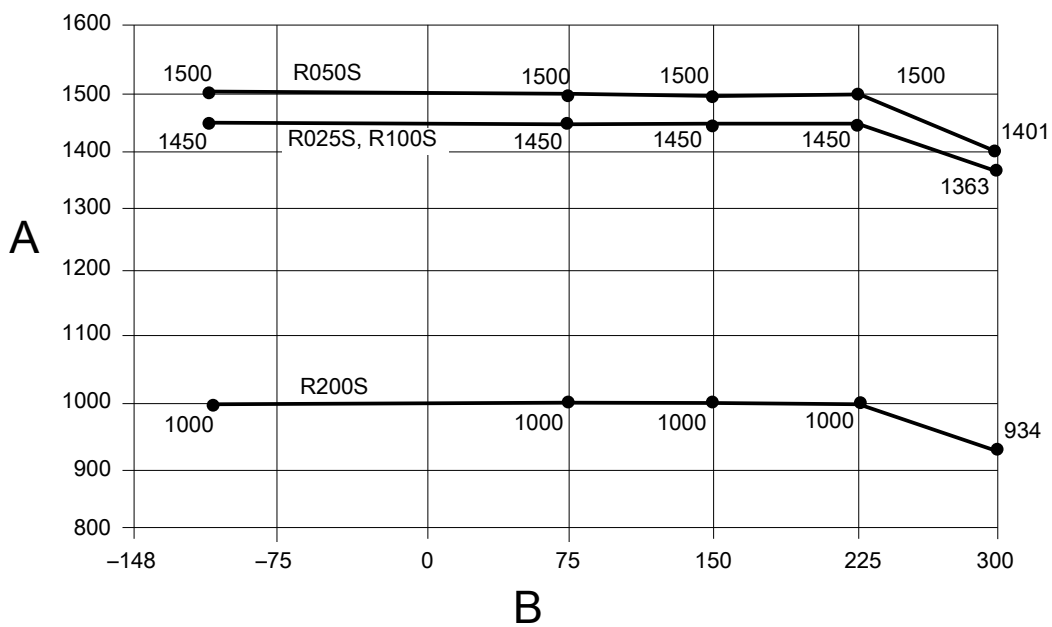

A. Pressure (psi)
 B. Temperature (° F)

VCO & VCR 316/316L

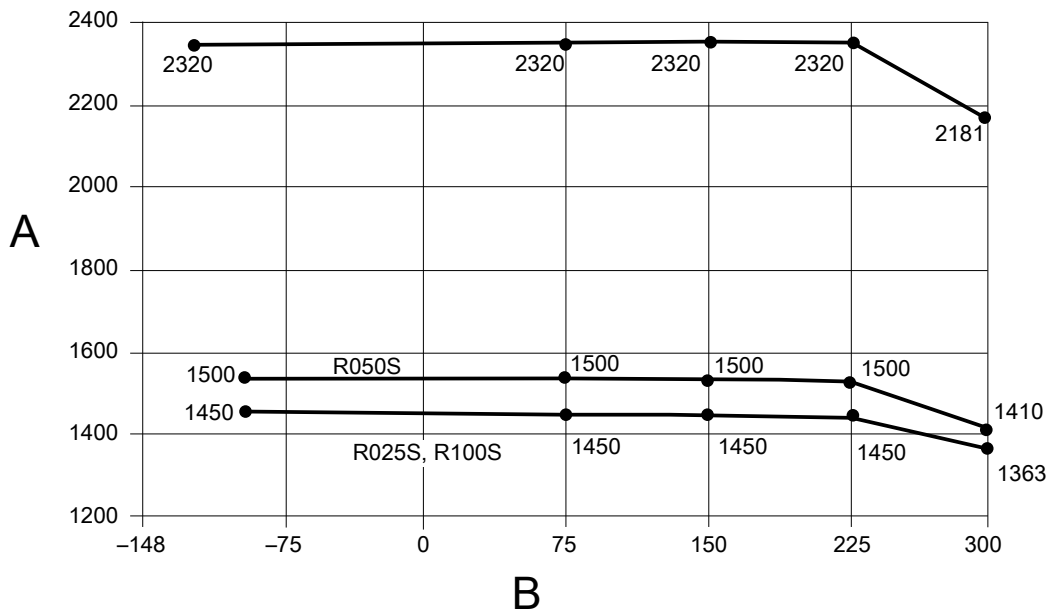

A. Pressure (psi)
 B. Temperature (°F)

Hazardous area classifications

Detailed classifications

Note

All information and approvals may change depending on sensor/transmitter configurations and operating conditions. Please reference appropriate certificates for exact approvals.

CSA and CSA C-US	
Sensor with integrally mounted Model 1700/2700 transmitter or with core processor	Ambient temperature: -40 to +140 °F (-40 to +60 °C)
	Class I, Div. 1, Groups C and D Class I, Div. 2, Groups A, B, C, and D Class II, Div. 1, Groups E, F, and G
	Class I, Div. 2, Groups A, B, C, and D
	Class II, Div. 1, Groups E, F, and G
IECEX and NEPSI	
Sensor with integrally mounted Model 1700/2700 transmitter or with core processor	Ex ib IIC T1-T5 Gb
Sensor with Model 1700/2700 with THUM adapter	Ex ib IIC T1-T4
ATEX	

All models (CIC A2) with core processor or Model 1700/2700 transmitter	 II 2G Ex ib IIC T1–T5 Gb II 2D Ex ib IIIC T °C ⁽¹⁾ Db IP65
--	--

(1) For ambient and process temperature limits, refer to the appropriate approval certificate.

Process connections

Note

The tables in this section do not represent all possible model and flange combinations. For combinations not listed here, contact a sales representative or the factory.

Dimensions with process connections

Dimension A is provided for each process fitting type, when available. It is the finished face-to-face dimension of the sensor with the process connection ± 0.125 in (± 3.18 mm).

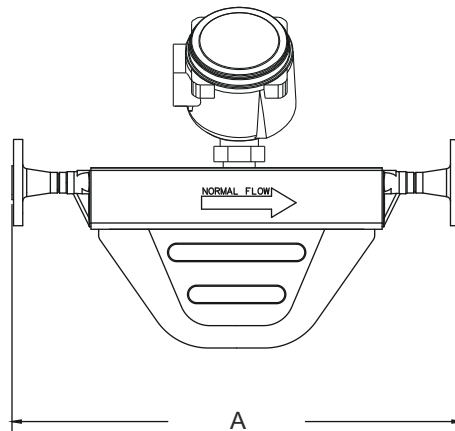

Weight with process connections

Product weights in this section include the weight of the sensor with the process connection and integral core processor, except where noted. Values are rounded to ± 1 lb (± 0.5 kg). Contact the factory for product shipping weight.

Fitting options

Model R025S

Code	Description						Dim A inch (mm)	Weight lb (kg)
113	1/2-inch	CL150	ASME B16.5	F316/F316L	Weld neck flange	Raised face	16.0 (406)	14 (6.5)
114	1/2-inch	CL300	ASME B16.5	F316/F316L	Weld neck flange	Raised face	16.4 (416)	15 (7)
115	1/2-inch	CL600	ASME B16.5	F316/F316L	Weld neck flange	Raised face	16.9 (428)	16 (7)
116	DN15	PN40	DIN 2635	F316/F316L	Weld neck flange	Form C face	15.3 (387)	15 (7)

Code	Description						Dim A inch (mm)	Weight lb (kg)
120	DN15	PN100/ 160	DIN 2638	F316/F316L	Weld neck flange	Form E face	15.8 (401)	17 (8)
121	1/2- inch		Tri-Clamp compatible	316L	Hygienic fitting		14.0 (355)	12 (5.5)
122	15mm	20K	JIS B 2220	F316/316L	Weld neck flange	Raised face	15.4 (392)	15 (7)
150	1/2- inch	CL900/1 500	ASME B16.5	F316/316L	Weld neck flange	Raised face	17.5 (445)	18 (8)
170	DN15	PN100/ 160	EN 1092-1	F316/F316L	Weld neck flange	Type B2	15.4 (391)	17 (8)
172	DN25	PN40	EN 1092-1	F316/F316L	Weld neck flange	Type B1	15.3 (387)	17 (8)
176	DN15	PN40	EN 1092-1	F316/F316L	Weld neck flange	Type B1	15.2 (387)	15 (7)
178	DN15	PN100	EN 1092-1	F316/F316L	Weld neck flange	Type D	15.4 (391)	17 (7.5)
183	DN25	PN40	EN 1092-1	F316/F316L	Weld neck flange	Type D	13.9 (353)	17 (8)
221	15mm	40K	JIS B 2220	F316/316L	Weld neck flange	Raised face	16.5 (419)	19 (9)
222	DN15		DIN11851	316/316L	Hygienic coupling		15.3 (387)	12 (5.5)
310	DN15	PN40	EN 1092-1	F316/F316L	Weld neck flange	Type D	14.0 (355)	15 (7)
319	#8		VCO	316/316L	Swagelok compatible fitting	1/2-inch NPT female adapter	15.8 (401) ⁽¹⁾	12 (5.5)
A94	½-inch	CL150	ASME B16.5	316/316L	Weld neck flange	Raised face 63-125 RA face finish	16 (406)	14 (6)
A95	½-inch	CL300	ASME B16.5	316/316L	Weld neck flange	Raised face 63-125 RA face finish	16.4 (416)	16 (7)
A96	½-inch	CL600	ASME B16.5	316/316L	Weld neck flange	Raised face 63-125 RA face finish	16.9 (429)	16 (7)
A97	½-inch	CL150	ASME B16.5	316/316L	Weld neck flange	Raised face 63-125 RA face finish	17.5 (445)	21 (10)
A99	½-inch	CL150	ASME B16.5	316/316L	Weld neck flange	Raised face	16.1 (410)	15 (7)
B01	¾-inch	CL300	ASME B16.5	316/316L	Weld neck flange	Raised face	16.5 (419)	18 (8)
B02	¾-inch	CL600	ASME B16.5	316/316L	Weld neck flange	Raised face	17.3 (438)	18 (8)

Code	Description						Dim A inch (mm)	Weight lb (kg)
B03	¾-inch	CL900/1 500	ASME B16.5	316/316L	Weld neck flange	Raised face	16.3 (413)	16 (7)
B04	1-inch	CL900/1 500	ASME B16.5	316/316L	Weld neck flange	Raised face	18.3 (464)	23 (10)
B05	1-inch	CL900/1 500	ASME B16.5	316/316L	Weld neck flange	Raised face	16.6 (422)	19 (9)
B06	1-inch	CL900/1 500	ASME B16.5	316/316L	Weld neck flange	Raised face	17.1 (435)	20 (9)
B07	1-inch	CL900/1 500	ASME B16.5	316/316L	Weld neck flange	Raised face	18 (457)	28 (13)
B09	1/2- inch	CL300	ASME B16.5	316/316L	Weld neck flange	RTJ face	16.8 (427)	16 (7)
B10	1/2- inch	CL600	ASME B16.5	316/316L	Weld neck flange	RTJ face	16.8 (427)	16.8 (427)
B77	#8		VCR	316/316L	Swagelok compatible fitting	1/2-inch 316 NPT female adapter	17.2 (437)	13 (6)
B78	#12		VCR	316/316L	Swagelok compatible fitting	3/4-inch 316 NPT female adapter	15.4 (391)	14 (6)
C73	DN15	PN40	EN 1092-1	316/316L	Weld neck flange	Type F	15.3 (387)	15 (7)

(1) Dimension specified in table does NOT include fitting length. For installation, modify Dim. A value to include fitting.

Model R025P

Code	Description						Dim A inch (mm)	Weight lb (kg)
120	DN15	PN100/ 160	DIN 2638	F316/F316L	Weld neck flange	Type E face	15.8 (401)	17 (8)
150	½-inch	CL900/1 500	ASME B16.5	F316/F316L	Weld neck flange	Raised face	17.5 (445)	18 (8)
170	DN15	PN100/ 160	EN 1092-1	F316/F316L	Weld neck flange	Form B2	15.8 (401)	17 (8)
178	DN15	PN100	EN 1092-1	F316/F316L	Weld neck flange	Form D	15.8 (401)	17 (7.5)
180	DN25	PN100	EN 1092-1	F316/F316L	Weld neck flange	Form B2	16.8 (427)	24 (10.5)
319	#8		VCO	316/316L	Swagelok compatible fitting	1/2-inch NPT female adapter	14.0 (355) ⁽¹⁾	12 (5.5)

(1) Dimension specified in table does NOT include fitting length. For installation, modify Dim. A value to include fitting.

Model R050S

Code	Description						Dim A inch (mm)	Weight lb (kg)
113	1/2-inch	CL150	ASME B16.5	F316/F316L	Weld neck flange	Raised face	18.1 (460)	15 (7)
114	1/2-inch	CL300	ASME B16.5	F316/F316L	Weld neck flange	Raised face	18.5 (469)	16 (7.5)
115	1/2-inch	CL600	ASME B16.5	F316/F316L	Weld neck flange	Raised face	19.0 (482)	17 (7.5)
116	DN15	PN40	DIN 2635	F316/F316L	Weld neck flange	Form C face	17.4 (441)	16 (7.5)
120	DN15	PN100/ 160	DIN 2638	F316/F316L	Weld neck flange	Form E face	17.9 (455)	18 (8.5)
122	15mm	20K	JIS B 2220	F316/316L	Weld neck flange	Raised face	17.6 (446)	18 (8)
131	DN25	PN40	DIN 2635	F316/F316L	Weld neck flange	Form C face	17.5 (444)	18 (8.5)
150	1/2-inch	CL900/1 500	ASME B16.5	F316/F316L	Weld neck flange	Raised face	19.7 (498)	19 (9)
170	DN15	PN100/ 160	EN 1092-1	F316/F316L	Weld neck flange	Type B2	17.9 (455)	18 (8.5)
172	DN25	PN40	EN 1092-1	F316/F316L	Weld neck flange	Type B1	17.5 (445)	18 (8.5)
176	DN15	PN40	EN 1092-1	F316/F316L	Weld neck flange	Type B1	17.4 (441)	16 (7.5)
178	DN15	PN100	EN 1092-1	F316/F316L	Weld neck flange	Type D	17.9 (455)	18 (8)
183	DN25	PN40	EN 1092-1	F316/F316L	Weld neck flange	Type D	17.5 (445)	18 (8.5)
221	15mm	40K	JIS B 2220	F316/316L	Weld neck flange	Raised face	18.6 (473)	19 (9)
222	DN15		DIN11851	316/316L	Hygienic coupling		16.0 (407)	13 (6)
239	#12		VCO	316/316L	Swagelok compatible fitting	3/4-inch NPT female adapter	16.4 (415)	14 (6)
310	DN15	PN40	EN 1092-1	F316/F316L	Weld neck flange	Type D	17.4 (441)	16 (7.5)
322	3/4-inch		Tri-Clamp compatible	316L	Hygienic fitting		15.9 (403)	13 (6)
A94	1/2-inch	CL150	ASME B16.5	F316/316L	Weld neck flange	Raised face 63-125 RA face finish	18.1 (460)	16 (7)
A95	1/2-inch	CL300	ASME B16.5	F316/316L	Weld neck flange	Raised face 63-125 RA face finish	18.5 (470)	17 (8)

Code	Description						Dim A inch (mm)	Weight lb (kg)
A96	1/2-inch	CL600	ASME B16.5	F316/316L	Weld neck flange	Raised face 63-125 RA face finish	19 (483)	17 (8)
A97	1/2-inch	CL900/1 500	ASME B16.5	F316/316L	Weld neck flange	Raised face 63-125 RA face finish	19.6 (498)	22 (10)
A99	3/4-inch	CL150	ASME B16.5	F316/316L	Weld neck flange	Raised face	18.3 (464)	16 (7)
B01	3/4-inch	CL300	ASME B16.5	F316/316L	Weld neck flange	Raised face	18.6 (473)	19 (9)
B02	3/4-inch	CL600	ASME B16.5	F316/316L	Weld neck flange	Raised face	19.4 (492)	19 (9)
B03	3/4-inch	CL900/1 500	ASME B16.5	F316/316L	Weld neck flange	Raised face	20.4 (517)	25 (11)
B04	1-inch	CL150	ASME B16.5	F316/316L	Weld neck flange	Raised face	18.4 (467)	17 (8)
B05	1-inch	CL150	ASME B16.5	F316/316L	Weld neck flange	Raised face	18.8 (476)	20 (9)
B06	1-inch	CL150	ASME B16.5	F316/316L	Weld neck flange	Raised face	19.3 (489)	21 (10)
B07	1-inch	CL150	ASME B16.5	F316/316L	Weld neck flange	Raised face	20.1 (511)	29 (13)
B09	1/2-inch	CL300	ASME B16.5	F316/316L	Weld neck flange	RTJ face	18.9 (481)	17 (8)
B10	1/2-inch	CL600	ASME B16.5	F316/316L	Weld neck flange	RTJ face	18.9 (481)	17 (8)
B11	1/2-inch	CL900/1 500	ASME B16.5	F316/316L	Weld neck flange	RTJ face	19.6 (498)	22 (10)
B77	#8		VCR	F316/316L	Swagelok compatible fitting	1/2-inch 316 NPT female adapter	19.3 (489)	14 (6)
B78	#12		VCR	F316/316L	Swagelok compatible fitting	3/4-inch 316 NPT female adapter	17.5 (445)	15 (7)
C73	DN15	PN40	EN 1092-1	F316/316L	Weld neck flange	Type F	17.4 (441)	17 (8)

Model R100S

Code	Description						Dim A inch (mm)	Weight lb (kg)
128	1-inch	CL150	ASME B16.5	F316/F316L	Weld neck flange	Raised face	22.7 (576)	24 (11)
129	1-inch	CL300	ASME B16.5	F316/F316L	Weld neck flange	Raised face	23.2 (588)	27 (12)

Code	Description						Dim A inch (mm)	Weight lb (kg)
130	1-inch	CL600	ASME B16.5	F316/F316L	Weld neck flange	Raised face	23.7 (601)	27 (12.5)
131	DN25	PN40	DIN 2635	F316/F316L	Weld neck flange	Form C face	21.4 (544)	25 (11.5)
137	DN25	PN100/ 160	DIN 2638	F316/F316L	Weld neck flange	Form E face	22.8 (580)	31 (14)
138	1-inch		Tri-Clamp compatible	316L	Hygienic fitting			
139	25mm	20K	JIS B 2220	F316/F316L	Weld neck flange	Raised face		
179	DN25	PN40	EN 1092-1	F316/F316L	Weld neck flange	Type B1	21.4 (544)	25 (11.5)
180	DN25	PN100	EN 1092-1	F316/F316L	Weld neck flange	Type B2	22.9 (580)	31 (14)
181	DN25	PN100	EN 1092-1	F316/F316L	Weld neck flange	Type D	22.9 (580)	31 (14)
209	2-inch	CL150	ASME B16.5	F316/F316L	Weld neck flange	Raised face	23.1 (585)	30 (13.5)
229	25mm	40K	JIS B 2220	F316/316L	Weld neck flange	Raised face	22.9 (582)	31 (14)
230	DN25		DIN11851	316/316L	Hygienic coupling		20.6 (522)	20 (9)
311	DN25	PN40	EN 1092-1	F316/F316L	Weld neck flange	Type D	21.4 (544)	25 (11.5)
928	1-inch	CL900/1 500	ASME B16.51	F316/F316L	Weld neck flange	Raised face	24.6 (624)	36 (16)
B14	1-inch	CL150	ASME B16.51	F316/F316L	Weld neck flange	Raised face 63-125 Ra face finish	22.7 (576)	24 (11)
B15	1-inch	CL300	ASME B16.51	F316/F316L	Weld neck flange	Raised face 63-125 Ra face finish	23.2 (589)	27 (12)
B16	1-inch	CL600	ASME B16.51	F316/F316L	Weld neck flange	Raised face 63-125 Ra face finish	23.7 (602)	28 (13)
B17	1 ½- inch	CL150	ASME B16.51	F316/F316L	Weld neck flange	Raised face	22.9 (583)	27 (12)
B18	1 ½- inch	CL300	ASME B16.51	F316/F316L	Weld neck flange	Raised face	23.4 (594)	32 (15)
B19	1 ½- inch	CL600	ASME B16.51	F316/F316L	Weld neck flange	Raised face	24.3 (616)	35 (16)
B20	1 ½- inch	CL900/1 500	ASME B16.51	F316/F316L	Weld neck flange	Raised face	24.8 (630)	46 (21)

Code	Description						Dim A inch (mm)	Weight lb (kg)
B21	2-inch	CL300	ASME B16.51	F316/F316L	Weld neck flange	Raised face	23.6 (598)	34 (15)
B22	2-inch	CL600	ASME B16.51	F316/F316L	Weld neck flange	Raised face	24.3 (616)	38 (17)
B23	2-inch	CL900/1 500	ASME B16.51	F316/F316L	Weld neck flange	Raised face	26.8 (679)	65 (29)
B24	1-inch	CL300	ASME B16.51	F316/F316L	Weld neck flange	RTJ face	23.7 (602)	27 (12)
B25	1-inch	CL600	ASME B16.51	F316/F316L	Weld neck flange	RTJ face	23.7 (602)	28 (13)
B26	1 1/2- inch	CL900/1 500	ASME B16.51	F316/F316L	Weld neck flange	RTJ face	25.3 (641)	46 (21)
B81	#16		VCO	F316/F316L	Swagelok compatible fitting	1-inch 316 NPT female adapter	20.3 (514)	22 (10)
B82	#16		VCR	F316/F316L	Swagelok compatible fitting	1-inch 316 NPT female adapter	22.7 (576)	23 (10)
C74	DN25	PN40	EN 1092-1	F316/F316L	Weld neck flange	Type F	21.4 (545)	25 (11)

Model R200S

Code	Description						Dim A inch (mm)	Weight lb (kg)
312	DN40	PN40	EN 1092-1	F316/F316L	Weld neck flange	Type D	23.4 (595)	48 (21.5)
316	DN50	PN40	EN 1092-1	F316/F316L	Weld neck flange	Type D	23.7 (601)	51 (23)
341	1-1/2- inch	CL150	ASME B16.5	F316/F316L	Weld neck flange	Raised face	24.8 (629)	46 (21)
342	1-1/2- inch	CL300	ASME B16.5	F316/F316L	Weld neck flange	Raised face	25.3 (642)	52 (23.5)
343	1-1/2- inch	CL600	ASME B16.5	F316/F316L	Weld neck flange	Raised face	25.8 (654)	55 (25)
351	1-1/2- inch		Tri-Clamp compatible	316L	Hygienic fitting		23.3 (591)	39 (17.5)
352	2-inch		Tri-Clamp compatible	316L	Hygienic fitting		22.9 (581)	39 (18)
353	DN40		DIN11851	316/316L	Hygienic coupling		23.2 (589)	46 (21)
363	DN40	PN100	EN 1092-1	F316/F316L	Weld neck flange	Type B2	24.8 (629)	56 (25.5)

Code	Description						Dim A inch (mm)	Weight lb (kg)
365	DN50	PN100	EN 1092-1	F316/F316L	Weld neck flange	Type B2	25.3 (641)	64 (29)
366	DN40	PN100	EN 1092-1	F316/F316L	Weld neck flange	Type D	24.8 (629)	56 (25.5)
367	DN50	PN100	EN 1092-1	F316/F316L	Weld neck flange	Type D	25.3 (641)	64 (29)
368	DN40	PN40	EN 1092-1	F316/F316L	Weld neck flange	Type B1	23.4 (595)	48 (21.5)
369	DN50	PN40	EN 1092-1	F316/F316L	Weld neck flange	Type B1	23.7 (601)	51 (23)
378	DN50	PN100	DIN 2637	F316/F316L	Weld neck flange	Form E face	25.4 (646)	64 (29)
381	DN40	PN40	DIN 2635	F316/F316L	Weld neck flange	Form C face	23.6 (599)	48 (21.5)
382	DN50	PN40	DIN 2635	F316/F316L	Weld neck flange	Form C face	23.8 (605)	51 (23)
385	40mm	10K	JIS B 2220	F316/F316L	Weld neck flange	Raised face	23.4 (595)	46 (21)
386	50mm	10K	JIS B 2220	F316/316L	Weld neck flange	Raised face	23.7 (602)	48 (22)
387	40mm	20K	JIS B 2220	F316/F316L	Weld neck flange	Raised face	23.4 (595)	47 (21)
388	50mm	20K	JIS B 2220	F316/316L	Weld neck flange	Raised face	23.7 (602)	48 (22)
418	2-inch	CL150	ASME B16.5	F316/F316L	Weld neck flange	Raised face	24.9 (632)	50 (22.5)
419	2-inch	CL300	ASME B16.5	F316/F316L	Weld neck flange	Raised face	25.4 (645)	54 (24.5)
420	2-inch	CL600	ASME B16.5	F316/F316L	Weld neck flange	Raised face	26.1 (664)	58 (26)
A31	1 ½-inch	CL900/1500	ASME B16.5	F316/F316L	Weld neck flange	Raised face	26.9 (683)	65 (29)
A32	1 ½-inch	CL150	ASME B16.5	F316/F316L	Weld neck flange	Raised face 63-125 Ra face finish	24.8 (629)	46 (21)
A33	1 ½-inch	CL300	ASME B16.5	F316/F316L	Weld neck flange	Raised face 63-125 Ra face finish	25.3 (641)	52 (24)
A34	1 ½-inch	CL600	ASME B16.5	F316/F316L	Weld neck flange	Raised face 63-125 Ra face finish	25.9 (657)	54 (24)
A35	2-inch	CL900/1500	ASME B16.5	F316/F316L	Weld neck flange	Raised face	27.4 (695)	83 (138)

Code	Description						Dim A inch (mm)	Weight lb (kg)
A36	3-inch	CL150	ASME B16.5	F316/F316L	Weld neck flange	Raised face	25.3 (641)	60 (27)
A37	3-inch	CL300	ASME B16.5	F316/F316L	Weld neck flange	Raised face	25.9 (657)	68 (61)
A38	3-inch	CL600	ASME B16.5	F316/F316L	Weld neck flange	Raised face	26.6 (676)	75 (34)
A39	2-inch	CL150	ASME B16.5	F316/F316L	Weld neck flange	Raised face 63-125 Ra face finish	24.8 (629)	50 (23)
A40	2-inch	CL300	ASME B16.5	F316/F316L	Weld neck flange	Raised face 63-125 Ra face finish	25.3 (641)	53 (24)
A41	2-inch	CL600	ASME B16.5	F316/F316L	Weld neck flange	Raised face 63-125 Ra face finish	26.1 (664)	57 (26)
A42	2-inch	CL150	ASME B16.5	F316/F316L	Weld neck flange	RTJ face	25.3 (641)	51 (23)
A43	2-inch	CL150	ASME B16.5	F316/F316L	Weld neck flange	RTJ face	26 (660)	55 (25)
A44	2-inch	CL150	ASME B16.5	F316/F316L	Weld neck flange	RTJ face	26.3 (667)	58 (26)
A45	2-inch	CL900/1 500	ASME B16.5	F316/F316L	Weld neck flange	RTJ face	27.5 (699)	84 (38)
B55	2-inch	CL600	ASME B16.5	A105 Carbon Steel	Lap joint flange	316/316L stub	24.8 (629)	57 (26)
B85	50 mm	10K	JIS B 2220	A105 Carbon Steel	Lap joint flange	316/316L stub	23.7 (602)	50 (23)
B86	50 mm	20K	JIS B 2220	A105 Carbon Steel	Lap joint flange	316/316L stub	23.7 (602)	50 (23)
C75	DN40	PN40	EN 1092-1	F316/F316L	Weld neck flange	Type F	23.4 (595)	48 (22)
C76	DN50	PN40	EN 1092-1	F316/F316L	Weld neck flange	Type F	23.7 (602)	51 (23)

R300S

Code	Description						Dim A inch (mm)	Weight lb (kg)
326	DN80	PN40	EN 1092-1	F316/F316L	Weld neck flange	Type D	35.9 (912)	138 (63)
333	DN100	PN40	EN 1092-1	F316/F316L	Weld neck flange	Type D	36.5 (926)	166 (75.5)

Code	Description						Dim A inch (mm)	Weight lb (kg)
355	3-inch	CL150	ASME B16.5	F316/F316L	Weld neck flange	Raised face	36.9 (935)	167 (76)
356	3-inch	CL300	ASME B16.5	F316/F316L	Weld neck flange	Raised face	37.6 (954)	167 (76)
357	3-inch	CL600	ASME B16.5	F316/F316L	Weld neck flange	Raised face	38.4 (974)	174 (79)
358	3-inch	CL900	ASME B16.5	F316/F316L	Weld neck flange	Raised face	37.7 (958)	123 (56)
359	DN100	PN100	EN 1092-1	F316/F316L	Weld neck flange	Type D	38.4 (976)	196 (89)
361	3-inch		Tri-Clamp compatible	316L	Hygienic fitting		35.1 (893)	196 (89)
371	DN80	PN40	EN 1092-1	F316/F316L	Weld neck flange	Type B1	35.9 (912)	158 (72)
372	DN100	PN40	EN 1092-1	F316/F316L	Weld neck flange	Type B1	36.5 (926)	146 (66.5)
373	DN80	PN100	EN 1092-1	F316/F316L	Weld neck flange	Type B2	37.5 (952)	176 (80)
374	DN100	PN100	EN 1092-1	F316/F316L	Weld neck flange	Type B2	38.4 (976)	198 (90)
375	DN80	PN100	EN 1092-1	F316/F316L	Weld neck flange	Type D	37.5 (952)	174 (79)
391	DN80	PN40	DIN 2635	F316/F316L	Weld neck flange	Form C face	36.0 (915)	137 (62)
392	DN100	PN40	DIN 2635	F316/F316L	Weld neck flange	Form C face	36.5 (926)	147 (66.5)
393	DN80	PN40	DIN 2635	F316/F316L	Weld neck flange	Form N grooved face	36.0 (915)	158 (71.5)
394	DN100	PN40	DIN 2635	F316/F316L	Weld neck flange	Form N grooved face	36.5 (926)	166 (75.5)
395	DN80	PN100	DIN 2637	F316/F316L	Weld neck flange	Form E face	37.8 (958)	176 (80)
396	DN100	PN100	DIN 2637	F316/F316L	Weld neck flange	Form E face	38.8 (983)	196 (89)
397	DN80	PN100	DIN 2637	F316/F316L	Weld neck flange	Form N grooved face	37.8 (958)	175 (79.5)
398	DN100	PN100	DIN 2637	F316/F316L	Weld neck flange	Form N grooved face	38.8 (983)	195 (89)
400	80mm	10K	JIS B 2220	F316/F316L	Weld neck flange	Raised face	36.5 (927)	154 (70)
401	100mm	10K	JIS B 2220	F316/F316L	Weld neck flange	Raised face	36.7 (932)	158 (72)

Code	Description						Dim A inch (mm)	Weight lb (kg)
402	80mm	20K	JIS B 2220	F316/F316L	Weld neck flange	Raised face	36.5 (927)	158 (71.5)
410	3-inch		Grooved coupling	316L	Hygienic coupling		36.9 (935)	196 (89)
425	4-inch	CL150	ASME B16.5	F316/F316L	Weld neck flange	Raised face	37.3 (945)	145 (66)
426	4-inch	CL300	ASME B16.5	F316/F316L	Weld neck flange	Raised face	38.1 (969)	184 (83.5)
427	4-inch	CL600	ASME B16.5	F316/F316L	Weld neck flange	Raised face	39.9 (1012)	212 (96.5)

Emerson Automation Solutions

Worldwide Headquarters
7070 Winchester Circle
Boulder, Colorado USA 80301
T: +1 800-522-6277
T: +1 303-527-5200
F: +1 303-530-8459
Mexico: 52 55 5809 5473
Argentina: 54 11 4733 5400
Brazil: 55 15 3413 8888
Chile: 56 22 4310 7432

Emerson Automation Solutions

Central Europe: +41 41 7686 111
Eastern Europe: +41 41 7686 111
Dubai: +971 4 811 8100
Abu Dhabi: +971 2 697 2000
Austria: +43 2236 607-0
France: 0800 917 901
Germany: +49 (0) 2173 3348 0
Italy: 8008 77334
The Netherlands: +31 318 495 555
Belgium: +32 2 716 77 11
Spain: 900 901 986
U.K.: 0870 240 1978
Russian/CIS: +7 495 995 9559

Emerson Automation Solutions

Australia: (61) 3 9721 0200
China: (86) 21 2892 9000
India: (91) 22 6662 0566
Japan: (81) 3 5769 6803
South Korea: (82) 31 8034 0000
Singapore: (65) 6 363 7766

©2020 Micro Motion, Inc. All rights reserved.

The Emerson logo is a trademark and service mark of Emerson Electric Co. Micro Motion, ELITE, ProLink, MVD and MVD Direct Connect marks are marks of one of the Emerson Automation Solutions family of companies. All other marks are property of their respective owners.